



**THE DATASHEET OF
MAX9503MEEE+**





DirectDrive Video Amplifier with Reconstruction Filter

MAX9503

General Description

The MAX9503 filters and amplifies standard-definition video signals. Maxim's DirectDrive™ technology eliminates large output-coupling capacitors and sets the video black level to ground. The input of the MAX9503 can be directly connected to the output of a video digital-to-analog converter (DAC). The MAX9503 provides a compact, integrated, and low-power solution.

An internal reconstruction filter smooths the steps and reduces the spikes on the video signal from the DAC. The reconstruction filter typically has 3dB attenuation at 9MHz and 50dB attenuation at 27MHz, and ± 1 dB pass-band flatness to 5.5MHz.

Maxim's DirectDrive uses an integrated charge pump and a linear regulator to create a clean negative power supply to drive the sync below ground. The charge pump injects so little noise into the video output that the picture is visibly flawless.

The MAX9503 is available with +6dB (MAX9503G) and +12dB (MAX9503M) gains. The device operates from a 2.7V to 3.6V single supply and features a 10nA low-power shutdown mode.

The MAX9503 is offered in space-saving 16-pin QSOP and 16-pin TQFN packages and is specified over the -40°C to $+85^{\circ}\text{C}$ extended temperature range.

Applications

Digital Still Cameras
Mobile Phones/Smartphones
Security Cameras
Portable Media Players
Space-Constrained, Low-Power Portable Devices

Features

- ◆ DC-Coupled Output
- ◆ Direct Connection to Video DAC
- ◆ Video Output Black Level Set to Ground
- ◆ Video Reconstruction Filter with 50dB Attenuation at 27MHz
- ◆ Preset Gain
6dB (MAX9503G)
12dB (MAX9503M)
- ◆ 10nA Shutdown Supply Current
- ◆ 2.7V to 3.6V Single-Supply Operation

Ordering Information

PART*	PIN-PACKAGE	PKG CODE	TOP MARK
MAX9503GEEE	16 QSOP	E16-4	—
MAX9503GETE	16 TQFN	T1633-4	ACU
MAX9503MEEE	16 QSOP	E16-4	—
MAX9503METE	16 TQFN	T1633-4	ACV

*All devices are specified over the -40°C to $+85^{\circ}\text{C}$ operating temperature range.

Functional Diagram/Typical Operating Circuit and Pin Configurations appear at end of data sheet.

Block Diagram

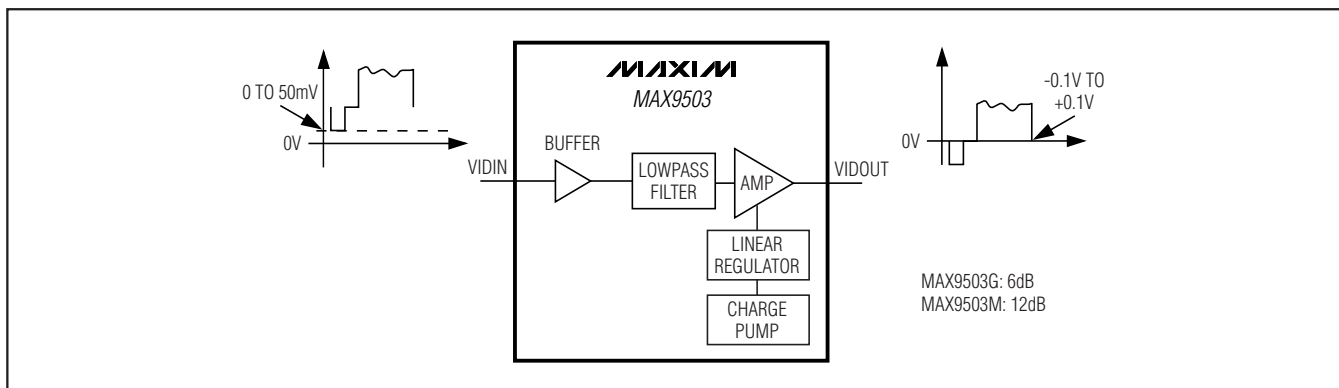

DirectDrive Video Amplifier with Reconstruction Filter

ABSOLUTE MAXIMUM RATINGS

V _{DD} to SGND	-0.3V to +4V	VIDOUT Short Circuit to V _{DD} , SGND and the Greater of (V _{SS} and -2V)	Continuous
VIDIN to SGND	-0.3V to +4V	Continuous Current	
BIAS to SGND	-0.3V to (V _{DD} + 0.3V)	VIDIN, BIAS, SHDN	±20mA
SHDN to SGND	-0.3V to +4V	Continuous Power Dissipation (T _A = +70°C)	
VIDOUT to SGND	(The greater of V _{SS} and -2V) to (V _{DD} + 0.3V)	16-Pin QSOP (derate 8.3mW/°C above +70°C)	667mW
CPV _{DD} to CPGND	-0.3V to +4V	16-Pin TQFN (derate 15.6mW/°C above +70°C)	1349mW
C1P, C1N, CPV _{SS}	Capacitor Connection Only	Operating Temperature Range	-40°C to +85°C
CPGND, SGND, GND	-0.1V to +0.1V	Junction Temperature	+150°C
CPV _{SS} to V _{SS}	-0.1V to +0.1V	Storage Temperature Range	-65°C to +150°C
		Lead Temperature (soldering, 10s)	+300°C

Stresses beyond those listed under "Absolute Maximum Ratings" may cause permanent damage to the device. These are stress ratings only, and functional operation of the device at these or any other conditions beyond those indicated in the operational sections of the specifications is not implied. Exposure to absolute maximum rating conditions for extended periods may affect device reliability.

ELECTRICAL CHARACTERISTICS

(V_{DD} = CPV_{DD} = SHDN = 3.0V, SGND = GND = CPGND = 0V, C1 = C2 = C3 = C4 = 1μF, R_{BIAS} = 100kΩ, T_A = T_{MIN} to T_{MAX}. R_L = 150Ω to SGND, unless otherwise noted. V_{VIDIN} = 286mV (MAX9503G), V_{VIDIN} = 143mV (MAX9503M). Typical values are at V_{DD} = CPV_{DD} = SHDN = 3.0V, T_A = +25°C, unless otherwise noted.) (Note 1)

PARAMETER	SYMBOL	CONDITIONS	MIN	TYP	MAX	UNITS	
Supply Voltage Range	V _{DD} , CPV _{DD}	Guaranteed by DC voltage gain and quiescent current	2.7		3.6	V	
Quiescent Supply Current	I _{DD}	V _{DD} = 3.6V (I _{DD} = I _{VDD} + I _{CPVDD} , R _L = ∞)		12	15	mA	
Shutdown Supply Current	I _{SHDN}	V _{DD} = 3.6V (I _{SHDN} = I _{VDD} + I _{CPVDD}), SHDN = SGND		0.01	1	μA	
Bias Voltage	V _{BIAS}			1		V	
VIDEO AMPLIFIER							
Input Voltage Range	V _{RANGE}	Guaranteed by DC voltage gain, V _{DD} = 2.7V	MAX9503G	-0.10	+1.05	V	
			MAX9503M	-0.050	+0.525		
		Guaranteed by DC voltage gain, V _{DD} = 3V	MAX9503G	-0.10	+1.28		
			MAX9503M	-0.05	+0.64		
Input Current	I _{IN}	V _{DD} = 2.7V	-2.5		+2.5	μA	
Input Resistance	R _{IN}			1		MΩ	
DC Voltage Gain (Note 2)	A _V	V _{DD} = 2.7V to 3.6V	MAX9503G	5.5	6	6.5	dB
			MAX9503M	11.5	12	12.5	
Output Black Level (Note 3)		V _{DD} = 2.7V	MAX9503G	-0.1	0	+0.1	V
			MAX9503M	-0.15	0	+0.15	
Output Voltage Swing		Guaranteed by DC voltage gain, V _{DD} = 2.7V	2.162			V _{P-P}	
		Guaranteed by DC voltage gain, V _{DD} = 3V	2.594				
Output Short-Circuit Current	I _{SC}	Sinking or sourcing		50		mA	
Output Resistance	R _{OUT}	MAX9503G	0.01			Ω	
		MAX9503M	0.02				
Shutdown Output Impedance	R _{OUTSHDN}	SHDN = SGND	MAX9503G	4.2			kΩ
			MAX9503M	8.2			

DirectDrive Video Amplifier with Reconstruction Filter

MAX9503

ELECTRICAL CHARACTERISTICS (continued)

($V_{DD} = CPV_{DD} = \overline{SHDN} = 3.0V$, $SGND = GND = CPGND = 0V$, $C1 = C2 = C3 = C4 = 1\mu F$, $R_{BIAS} = 100k\Omega$, $T_A = T_{MIN}$ to T_{MAX} . $R_L = 150\Omega$ to $SGND$, unless otherwise noted. $V_{VIDIN} = 286mV$ (MAX9503G), $V_{VIDIN} = 143mV$ (MAX9503M). Typical values are at $V_{DD} = CPV_{DD} = \overline{SHDN} = 3.0V$, $T_A = +25^\circ C$, unless otherwise noted.) (Note 1)

PARAMETER	SYMBOL	CONDITIONS	MIN	TYP	MAX	UNITS
CHARGE PUMP						
Switching Frequency			150	250	300	kHz
LOGIC SIGNALS						
Logic-Low Threshold	V_{IL}	$V_{DD} = 2.7V$ to $3.6V$			0.5	V
Logic-High Threshold	V_{IH}	$V_{DD} = 2.7V$ to $3.6V$	1.5			V
Logic Input Current	I_{IL}				1	μA

AC ELECTRICAL CHARACTERISTICS

($V_{DD} = CPV_{DD} = \overline{SHDN} = 3.0V$, $SGND = GND = CPGND = 0V$, $C1 = C2 = C3 = C4 = 1\mu F$, $R_{BIAS} = 100k\Omega$, $T_A = T_{MIN}$ to T_{MAX} . $R_L = 150\Omega$ to $SGND$, unless otherwise noted. $V_{VIDIN} = 286mV$ (MAX9503G), $V_{VIDIN} = 143mV$ (MAX9503M). Typical values are at $V_{DD} = CPV_{DD} = \overline{SHDN} = 3.0V$, $T_A = +25^\circ C$, unless otherwise noted.) (Note 1)

PARAMETER	SYMBOL	CONDITIONS	MIN	TYP	MAX	UNITS
Passband Flatness		$V_{DD} = 2.7V$, $f = 100kHz$ to $5.5MHz$	-1	0	+1	dB
Attenuation		$V_{DD} = 2.7V$, $V_{IDOUT} = 2V_{P-P}$, attenuation is referred to $100kHz$	$f = 9.1MHz$	3		dB
			$f = 27MHz$	35	50	
Power-Supply Rejection Ratio	PSRR	$f = 100kHz$	MAX9503G	62		dB
			MAX9503M	56		
Output Impedance	Z_{OUT}	$f = 5MHz$	MAX9503G	0.5		Ω
			MAX9503M	0.65		
Differential Gain Error	DG	NTSC, $V_{IDOUT} = 2V_{P-P}$	MAX9503G	0.1		%
			MAX9503M	0.1		
Differential Phase Error	DP	NTSC, $V_{IDOUT} = 2V_{P-P}$	MAX9503G	0.2		Degrees
			MAX9503M	0.2		
2T Pulse-to-Bar K Rating		$2T = 250ns$, bar time is $18\mu s$, the beginning 2.5% and the ending 2.5% of the bar time are ignored		-0.3		K%
2T Pulse Response		$2T = 250ns$		0.3		K%
2T Bar Response		$2T = 250ns$, bar time is $18\mu s$, the beginning 2.5% and the ending 2.5% of the bar time are ignored		0.7		K%
Nonlinearity		5-step staircase		0.2		%
Group-Delay Distortion	DD_t	$100kHz$ to $5.5MHz$		10		ns
V_{IDOUT} Capacitive-Load Stability	C_L	$V_{OUT} = 2V_{P-P}$, no sustained oscillations		20		pF

DirectDrive Video Amplifier with Reconstruction Filter

AC ELECTRICAL CHARACTERISTICS (continued)

($V_{DD} = CPV_{DD} = \overline{SHDN} = 3.0V$, $SGND = GND = CPGND = 0V$, $C1 = C2 = C3 = C4 = 1\mu F$, $R_{BIAS} = 100k\Omega$, $T_A = T_{MIN}$ to T_{MAX} . $R_L = 150\Omega$ to $SGND$, unless otherwise noted. $V_{VIDIN} = 286mV$ (MAX9503G), $V_{VIDIN} = 143mV$ (MAX9503M). Typical values are at $V_{DD} = CPV_{DD} = \overline{SHDN} = 3.0V$, $T_A = +25^\circ C$, unless otherwise noted.) (Note 1)

PARAMETER	SYMBOL	CONDITIONS		MIN	TYP	MAX	UNITS
Peak Signal-to-RMS Noise	SNR	100kHz to 5.5MHz	MAX9503G		64		dB
			MAX9503M		58		
Enable Time	t_{ON}	VIDIN = 0.5V, VIDOUT settled to within 1% of the final voltage			0.2		ms
Disable Time	t_{OFF}	VIDIN = 0.5V, VIDOUT settled to below 1% of the output voltage			0.1		ms

Note 1: All devices are 100% production tested at $T_A = +25^\circ C$. Specifications over temperature are guaranteed by design.

Note 2: Voltage gain (A_V) is a two-point measurement in which the output voltage swing is divided by the input voltage swing.

Note 3: With an output load attached, this offset will directly contribute to quiescent current.

Typical Operating Characteristics

($V_{DD} = CPV_{DD} = \overline{SHDN} = 3.0V$, $SGND = GND = CPGND = 0V$, no load, $C1 = C2 = C3 = C4 = 1\mu F$, $R_{BIAS} = 100k\Omega$, $T_A = T_{MIN}$ to T_{MAX} . $R_{IN} = 150\Omega$ to $SGND$, unless otherwise noted. $V_{VIDIN} = 286mV$ (MAX9503G), $V_{VIDIN} = 143mV$ (MAX9503M). Typical values are at $T_A = +25^\circ C$, unless otherwise noted.)

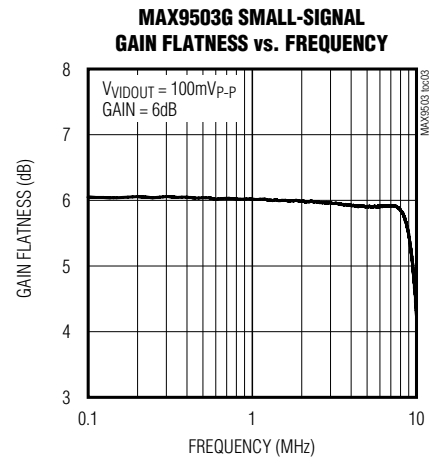
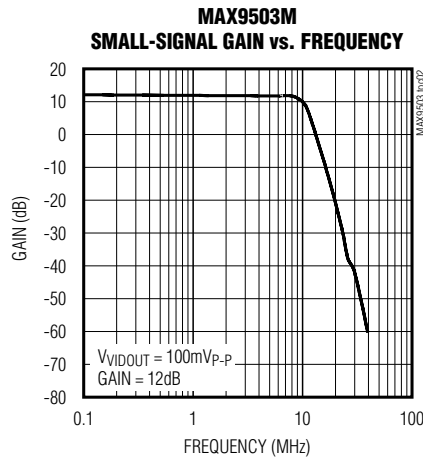
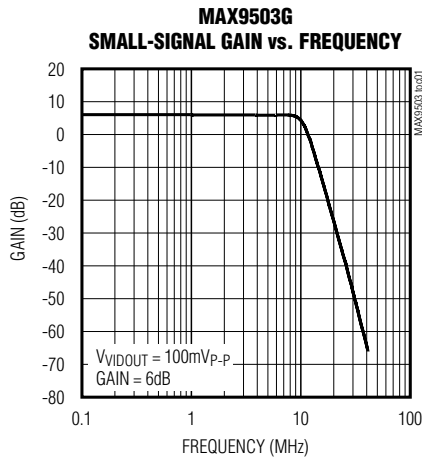

DirectDrive Video Amplifier with Reconstruction Filter

MAX9503

Typical Operating Characteristics (continued)

($V_{DD} = CPV_{DD} = \overline{SHDN} = 3.0V$, $SGND = GND = CPGND = 0V$, no load, $C1 = C2 = C3 = C4 = 1\mu F$, $R_{BIAS} = 100k\Omega$, $T_A = T_{MIN}$ to T_{MAX} . $R_{IN} = 150\Omega$ to $SGND$, unless otherwise noted. $V_{VIDIN} = 286mV$ (MAX9503G), $V_{VIDIN} = 143mV$ (MAX9503M). Typical values are at $T_A = +25^\circ C$, unless otherwise noted.)

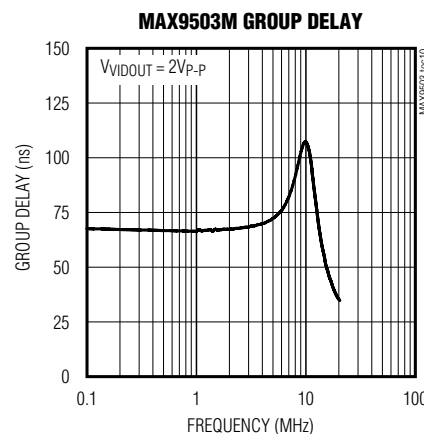
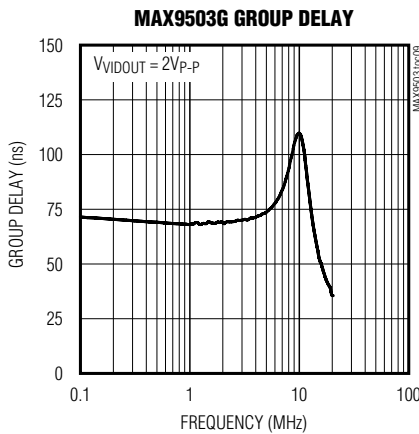
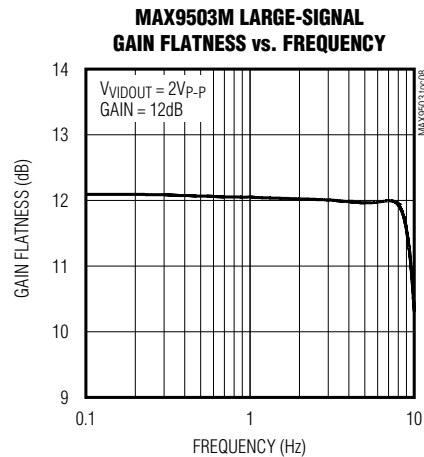
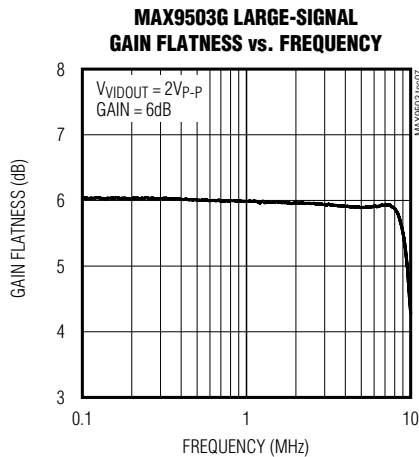
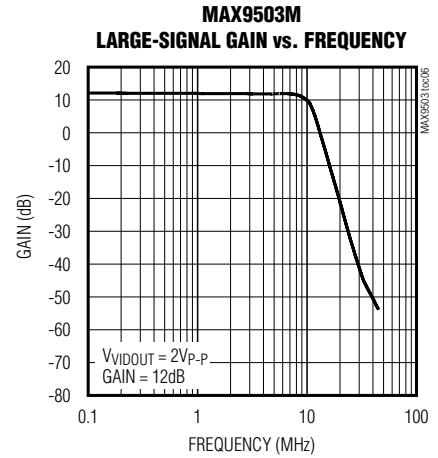
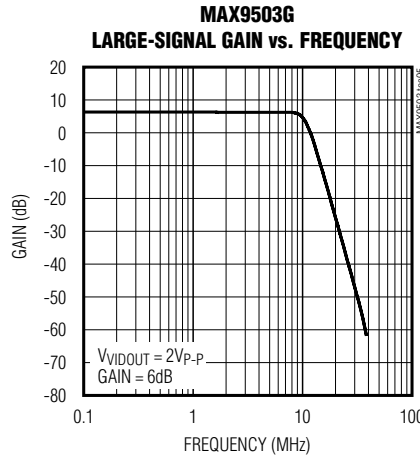
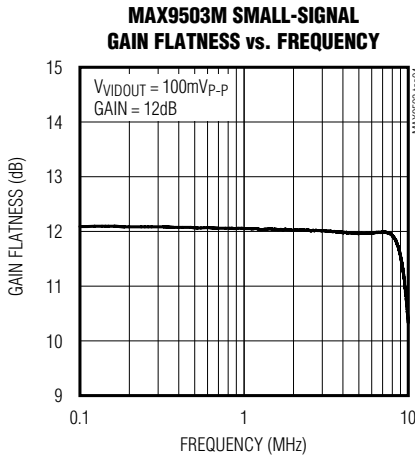

DirectDrive Video Amplifier with Reconstruction Filter

Typical Operating Characteristics (continued)

($V_{DD} = CPV_{DD} = \overline{SHDN} = 3.0V$, $SGND = GND = CPGND = 0V$, no load, $C1 = C2 = C3 = C4 = 1\mu F$, $R_{BIAS} = 100k\Omega$, $T_A = T_{MIN}$ to T_{MAX} . $R_{IN} = 150\Omega$ to $SGND$, unless otherwise noted. $V_{VIDIN} = 286mV$ (MAX9503G), $V_{VIDIN} = 143mV$ (MAX9503M). Typical values are at $T_A = +25^\circ C$, unless otherwise noted.)

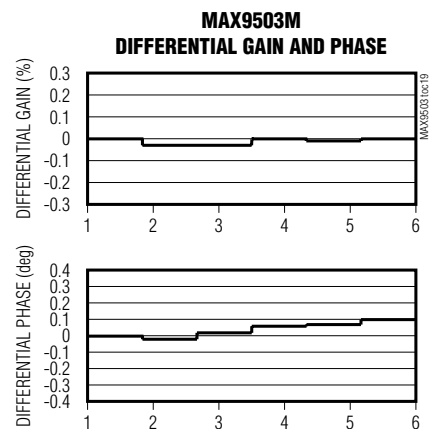
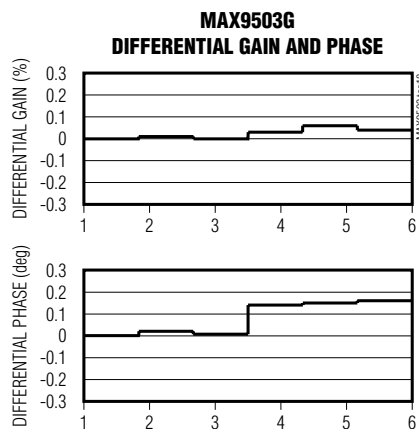
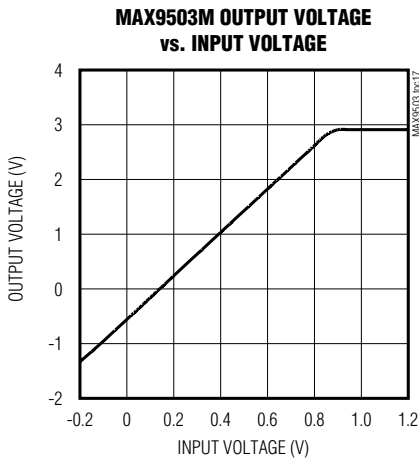
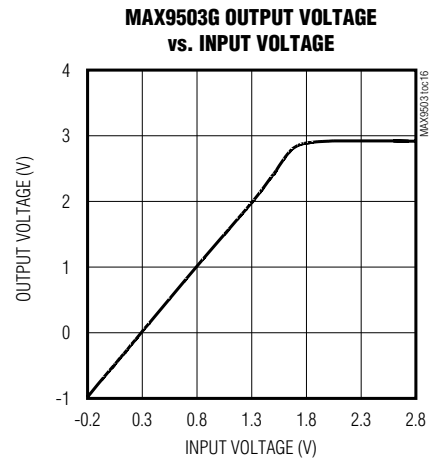
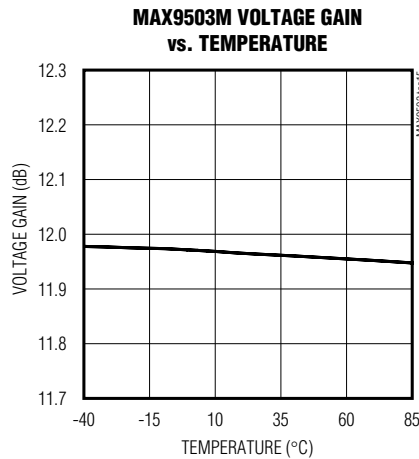
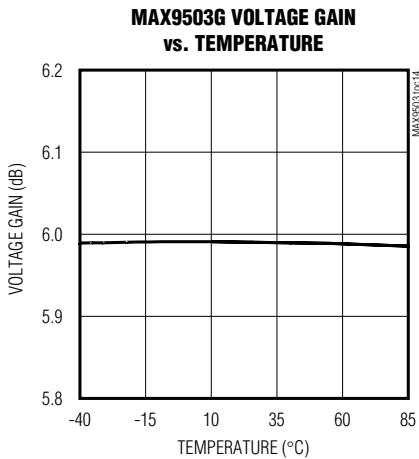
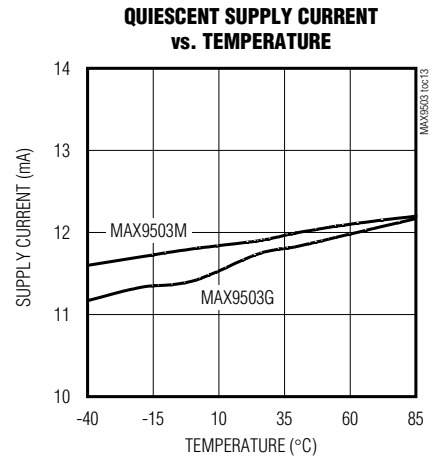
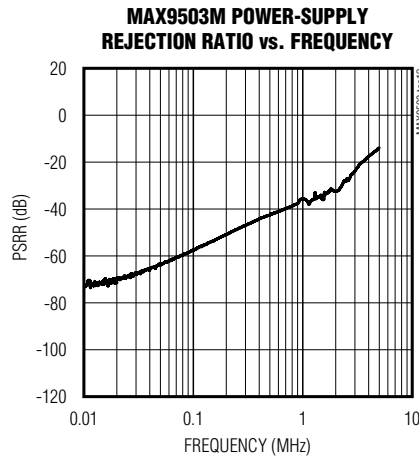
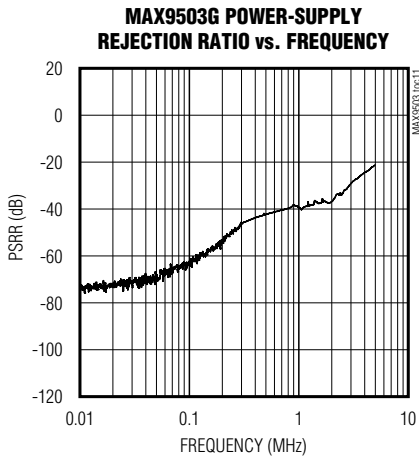

DirectDrive Video Amplifier with Reconstruction Filter

MAX9503

Typical Operating Characteristics (continued)

($V_{DD} = CPV_{DD} = \overline{SHDN} = 3.0V$, $SGND = GND = CPGND = 0V$, no load, $C1 = C2 = C3 = C4 = 1\mu F$, $R_{BIAS} = 100k\Omega$, $T_A = T_{MIN}$ to T_{MAX} . $R_{IN} = 150\Omega$ to $SGND$, unless otherwise noted. $V_{VIDIN} = 286mV$ (MAX9503G), $V_{VIDIN} = 143mV$ (MAX9503M). Typical values are at $T_A = +25^\circ C$, unless otherwise noted.)

MAX9503G 2T RESPONSE

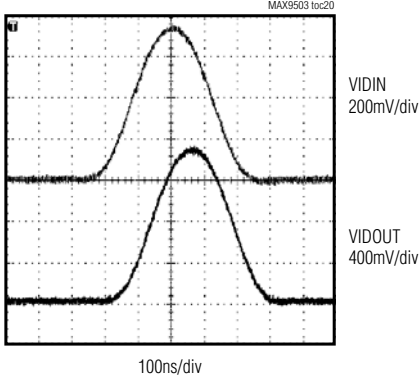

MAX9503M 2T RESPONSE

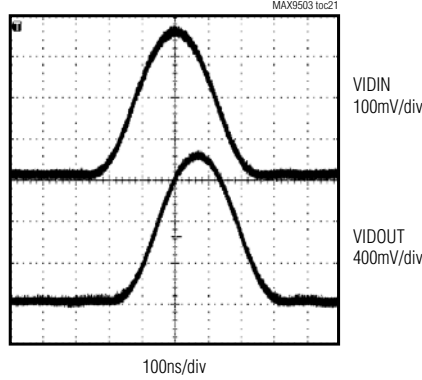

MAX9503G 12.5T RESPONSE

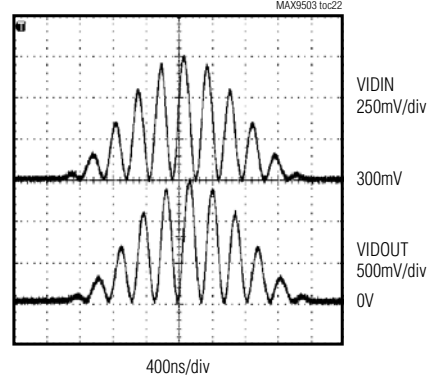

MAX9503M 12.5T RESPONSE

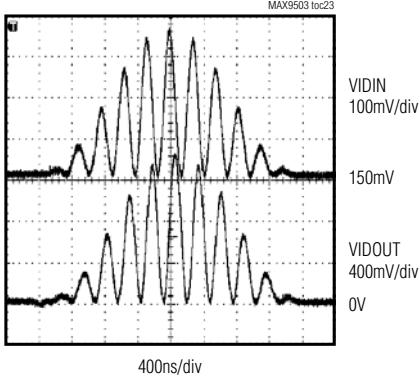

MAX9503G OUT RESPONSE TO NTC-7 VIDEO TEST SIGNAL

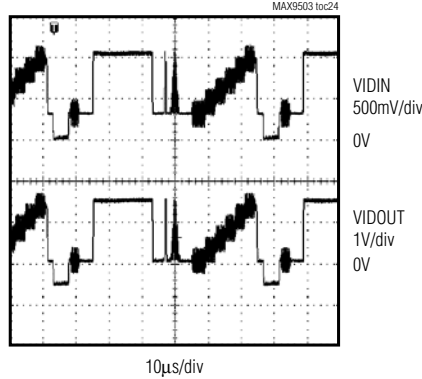

MAX9503M OUT RESPONSE TO NTC-7 VIDEO TEST SIGNAL

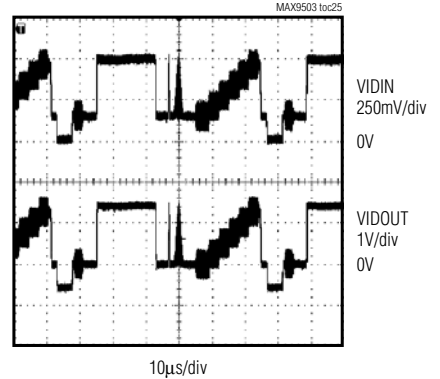

MAX9503G OUT RESPONSE TO BLACK-TO-WHITE VIDEO TEST SIGNAL

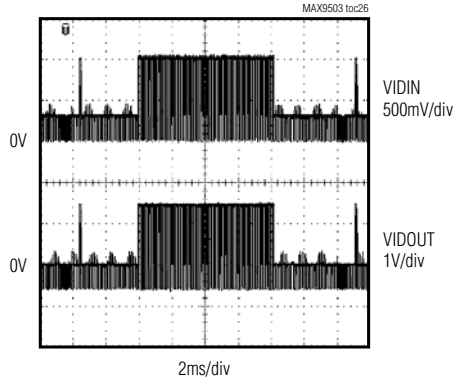

MAX9503M OUT RESPONSE TO BLACK-TO-WHITE VIDEO TEST SIGNAL

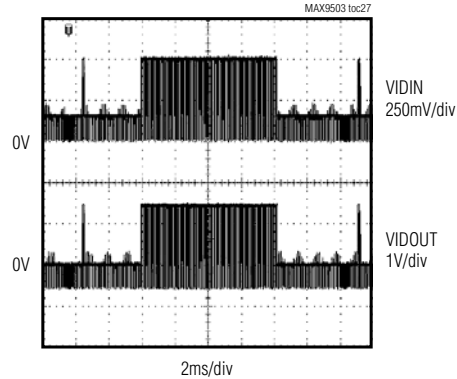

DirectDrive Video Amplifier with Reconstruction Filter

Pin Description

PIN		NAME	FUNCTION
QSOP	TQFN		
1	15	V _{SS}	Negative Power Supply. Connect to CPV _{SS} .
2	16	CPV _{SS}	Charge-Pump Negative Power Supply. Bypass with a 1μF capacitor to CPGND.
3	1	C1N	Charge-Pump Flying Capacitor Negative Terminal. Connect a 1μF capacitor from C1P to C1N.
4	2	CPGND	Charge-Pump Power Ground
5	3	C1P	Charge-Pump Flying Capacitor Positive Terminal. Connect a 1μF capacitor from C1P to C1N.
6	4	CPV _{DD}	Charge-Pump Positive Power Supply. Bypass with a 1μF capacitor to CPGND.
7	5	BIAS	Common-Mode Voltage. Connect a 100kΩ resistor from BIAS to SGND.
8	6	SGND	Signal Ground. Connect to GND.
9	7	VIDIN	Video Input
10, 14, 15	8, 12, 14	N.C.	No Connection. Not internally connected. Connect to SGND.
11	9	SHDN	Active-Low Shutdown. Connect to V _{DD} for normal operation.
12	10	GND	Ground. Connect to SGND.
13	11	V _{DD}	Positive Power Supply. Bypass with a 1μF capacitor to SGND.
16	13	VIDOUT	Video Output
—	EP	EP	Exposed Paddle. Connect to GND.

Detailed Description

The MAX9503 completely eliminates the need for capacitors in the video output by using Maxim's DirectDrive technology that includes an inverting charge pump and linear regulator. The charge pump and linear regulator create a clean negative supply allowing the amplifier output to swing below ground. The amplifier output can swing both positive and negative so that the video signal black level can be placed at ground. The MAX9503 features a six-pole, Butterworth filter to perform reconstruction filtering on the video input signal from the DAC.

DirectDrive Background

Integrated video filter/amplifier circuits operating from a single, positive supply usually create video output signals that are level-shifted above ground to keep the signal within the linear range of the output amplifier. For applications in which the positive DC level shift of the video signal is not acceptable, a series capacitor can be inserted in the output connection in an attempt to eliminate the positive DC level shift. The series capacitor cannot truly level shift a video signal because the average level of the video varies with picture content. The series capacitor biases the video output signal around ground, but the actual level of the video signal can vary significantly depending upon the RC time constant and the picture content.

The series capacitor creates a highpass filter. Since the lowest frequency in video is the frame rate, which can be between 24Hz and 30Hz, the pole of the highpass filter should ideally be an order of magnitude lower in frequency than the frame rate. Therefore, the series capacitor must be very large, typically from 220μF to 3000μF. For space-constrained equipment, the series capacitor is unacceptable. Changing from a single series capacitor to a SAG network that requires two smaller capacitors can only reduce space and cost slightly.

The series capacitor in the usual output connection also prevents damage to the output amplifier if the connector is shorted to a supply or to ground. While the output connection of the MAX9503 does not have a series capacitor, the MAX9503 will not be damaged if the connector is shorted to a supply or to ground (see the *Short-Circuit Protection* section).

Video Amplifier

Typically, the black level of the video signal created by the video DAC is around 300mV. The MAX9503 shifts the black level to ground at the output so that the active video is above ground, and sync is below ground. The amplifier needs a negative supply for its output stage to remain in its linear region when driving sync below ground.

DirectDrive Video Amplifier with Reconstruction Filter

MAX9503

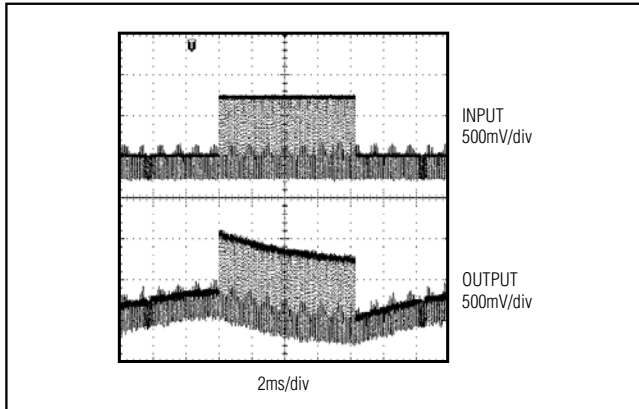

Figure 1. AC-Coupled Output

The MAX9503 has an integrated charge pump and linear regulator to create a low-noise negative supply from the positive supply voltage. The charge pump inverts the positive supply to create a raw negative voltage that is then fed into the linear regulator, which outputs -2V. The linear regulator filters out the charge-pump noise.

Comparison Between DirectDrive Output vs. AC-Coupled Output

The actual level of the video signal varies less with a DirectDrive output than an AC-coupled output. The video signal average can change greatly depending upon the picture content. With an AC-coupled output, the average will change according to the time constant formed by the series capacitor and series resistance (usually 150 Ω). For example, Figure 1 shows an AC-coupled video signal alternating between a completely black screen and a completely white screen. Notice the excursion of the video signal as the screen changes.

With the DirectDrive amplifier, the black level is held at ground. The video signal is constrained between -0.3V to +0.7V. Figure 2 shows the video signal from a DirectDrive amplifier with the same input signal as the AC-coupled system.

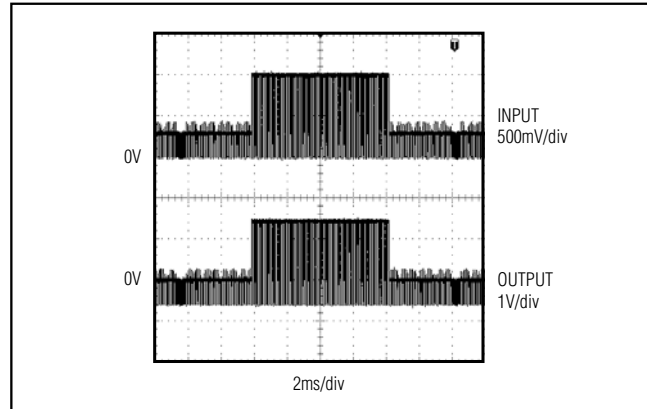

Figure 2. DirectDrive Output

Video Reconstruction Filter

Before the video signal from the DAC can be amplified, it must be lowpass filtered to smooth the steps and to reduce the spikes created whenever the DAC output changes value. In the frequency domain, the steps and spikes cause images of the video signal to appear at multiples of the sampling clock. The MAX9503 contains a six-pole Butterworth lowpass filter. The passband extends to 5.5MHz, and the minimum attenuation is 35dB at 27MHz.

Short-Circuit Protection

The MAX9503 typical application circuit includes a 75 Ω back-termination resistor that limits short-circuit current if an external short is applied to the video output. The MAX9503 features internal output, short-circuit protection to prevent device damage in prototyping and applications where the amplifier output can be directly shorted.

Shutdown

The MAX9503 features a low-power shutdown mode for battery-powered/portable applications. Shutdown reduces the quiescent current to less than 10nA. Connecting SHDN to ground (SGND) disables the outputs and places the MAX9503 into a low-power shutdown mode. In shutdown mode, the amplifier, charge pump, and linear regulator are turned off and the video output impedance is 4k Ω .

DirectDrive Video Amplifier with Reconstruction Filter

Applications Information

Power-Supply Bypassing and Ground Management

The MAX9503 operates from a 2.7V to 3.6V single supply and requires proper layout and bypassing. For the best performance, place the components as close to the device as possible.

Proper grounding improves performance and prevents any switching noise from coupling into the video signal. Connect GND and SGND together at a single point on the PC board. Route all traces that carry switching tran-

sients away from SGND. Return SGND to the lowest impedance ground available. Route CPGND and all traces carrying switching transients away from SGND, GND, and other traces and components in the video signal path. Bypass the analog supply (VDD) with a 1 μ F capacitor to SGND, placed as close to the device as possible. Bypass the charge-pump supply (CPVDD) with a 1 μ F capacitor to CPGND, placed as close to the device as possible. Connect CPVSS to VSS and bypass with a 1 μ F capacitor to CPGND as close to the device as possible.

Pin Configurations

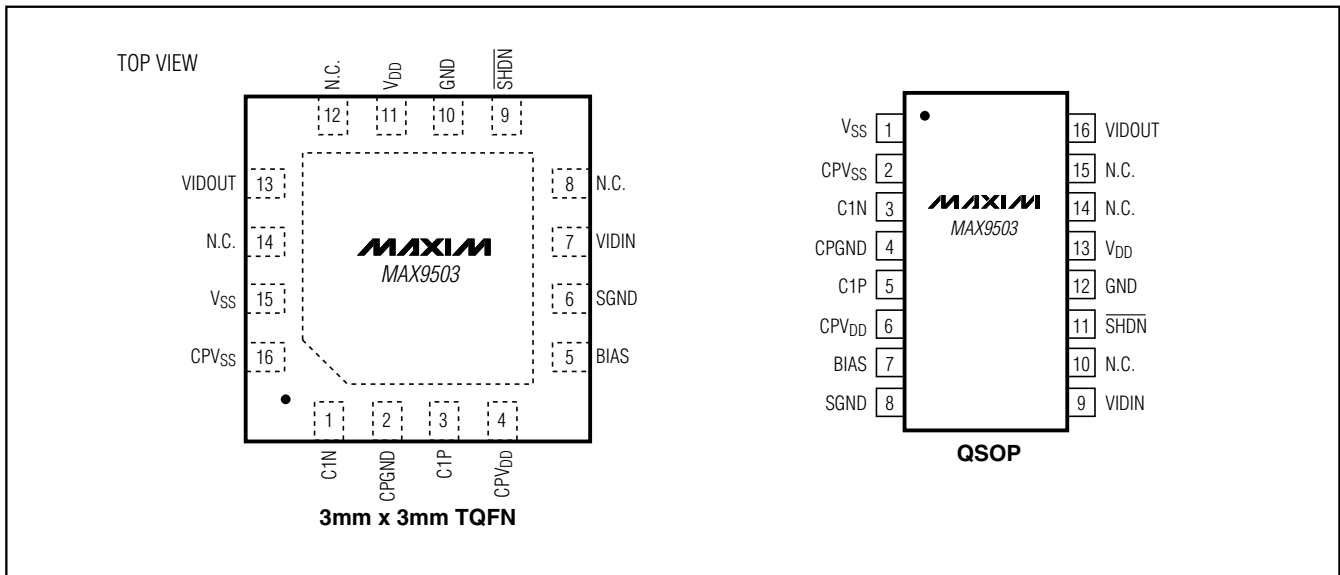

DirectDrive Video Amplifier with Reconstruction Filter

Functional Diagram/Typical Operating Circuit

MAX9503

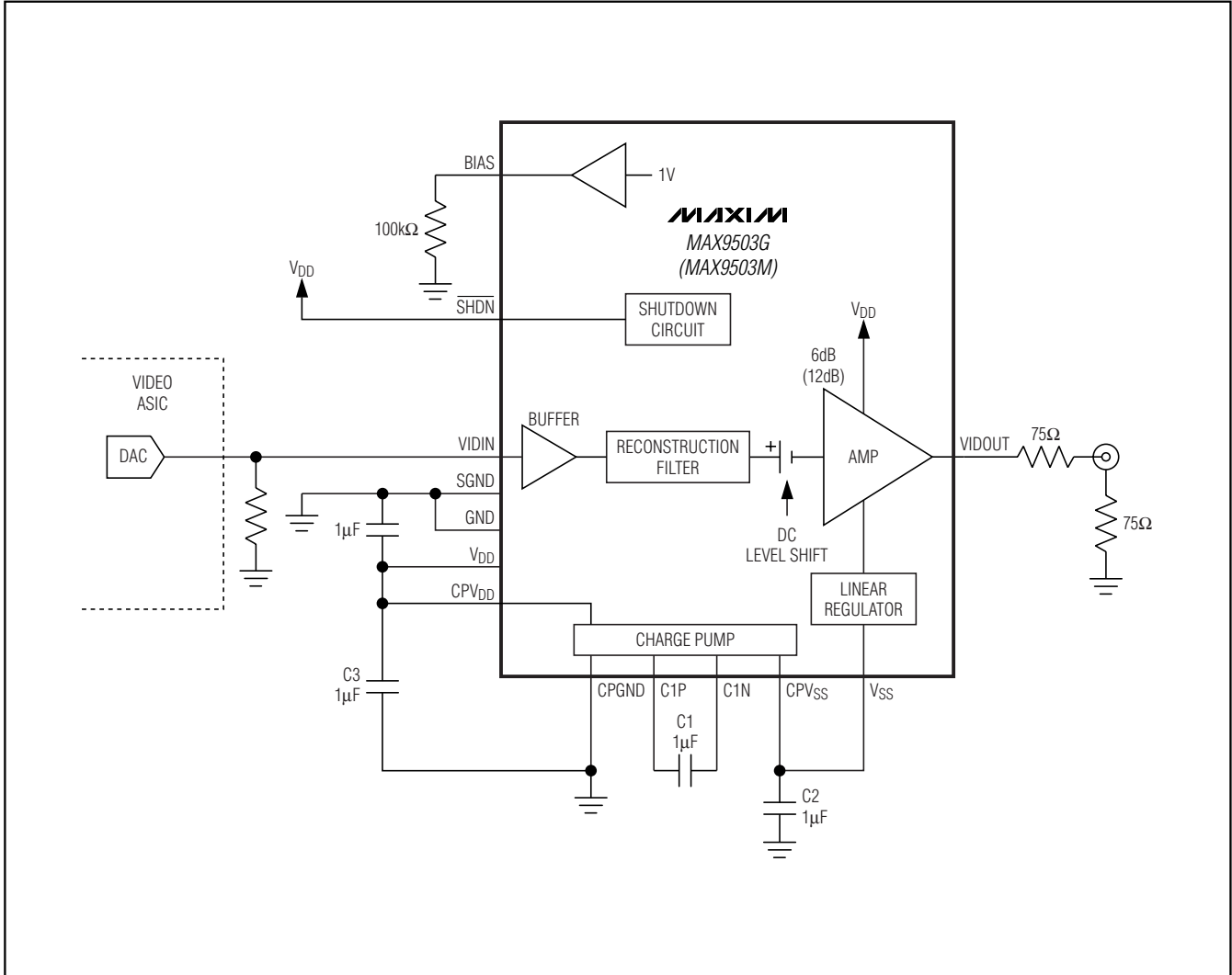

Chip Information

PROCESS: BiCMOS

DirectDrive Video Amplifier with Reconstruction Filter

Package Information

(The package drawing(s) in this data sheet may not reflect the most current specifications. For the latest package outline information, go to www.maxim-ic.com/packages.)

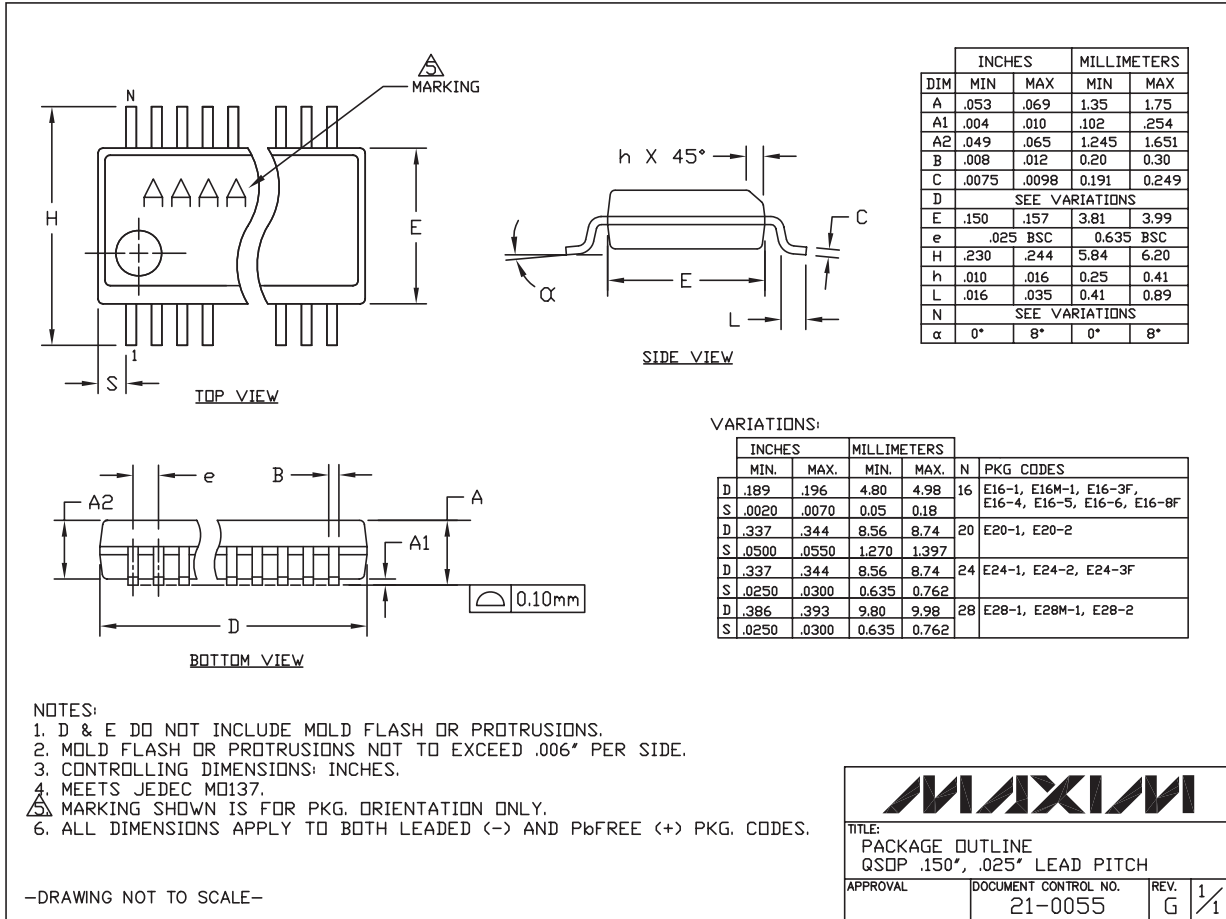

QSDP.EPS

DirectDrive Video Amplifier with Reconstruction Filter

Package Information (continued)

(The package drawing(s) in this data sheet may not reflect the most current specifications. For the latest package outline information, go to www.maxim-ic.com/packages.)

MAX9503

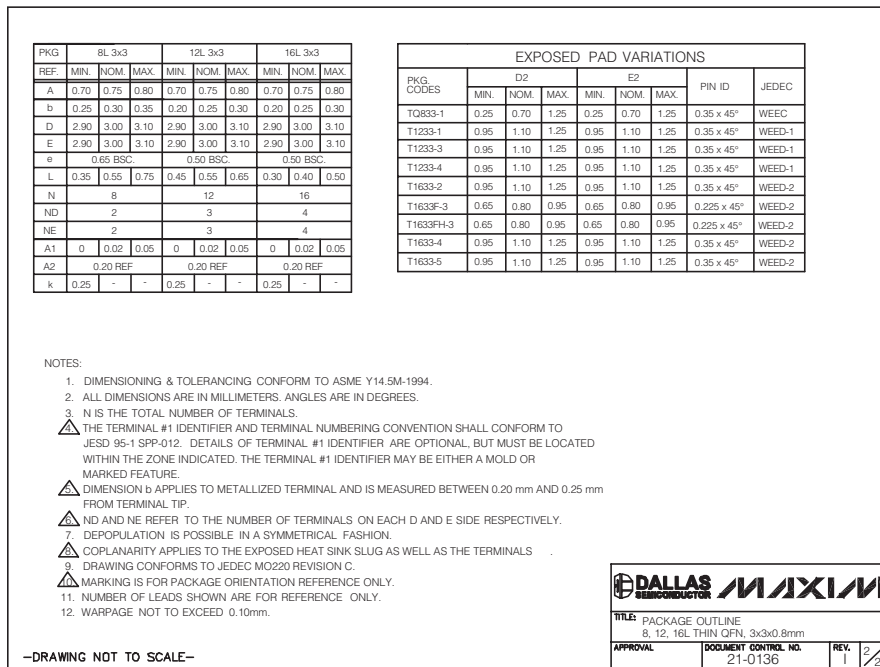
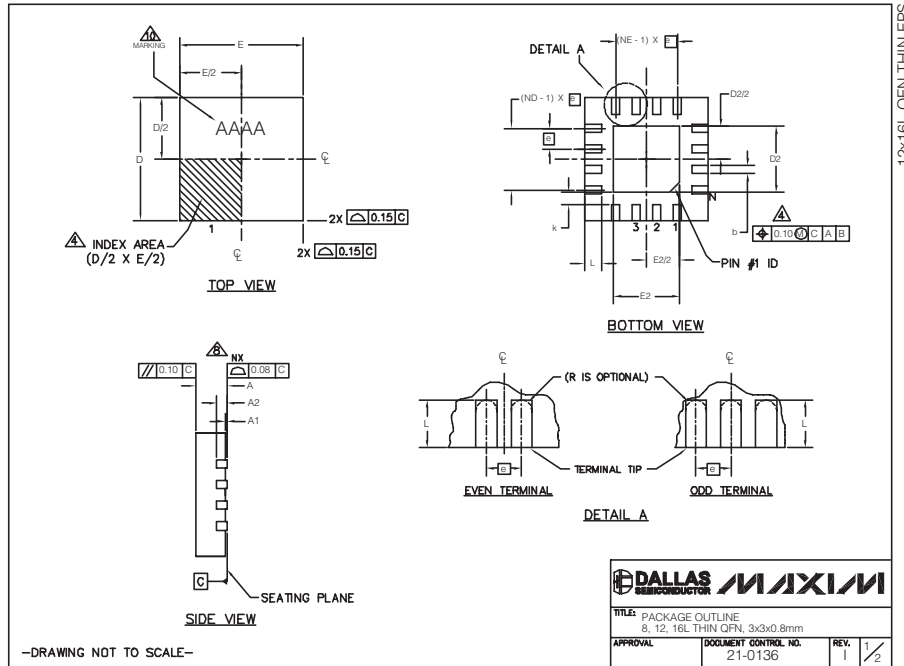

Maxim cannot assume responsibility for use of any circuitry other than circuitry entirely embodied in a Maxim product. No circuit patent licenses are implied. Maxim reserves the right to change the circuitry and specifications without notice at any time.

Maxim Integrated Products, 120 San Gabriel Drive, Sunnyvale, CA 94086 408-737-7600 13

Looking for pricing, stock, or lifecycle information?

Click below to explore more details on WIN SOURCE:

 [View MAX9503MEEE+ on WIN SOURCE](#)

 [Maxim Integrated](#) Information

Optimize Your Supply Chain with WIN SOURCE Solutions

-  Global Sourcing Solution
-  Obsolete Management
-  Cost Control Management
-  Shortage Management
-  Alternative Solution
-  Excess Inventory Management