



# THE DATASHEET OF MAX8215ESD-T





# ±5V, ±12V (±15V) Dedicated Microprocessor Voltage Monitors

## General Description

The MAX8215 contains five voltage comparators; four are for monitoring +5V, -5V, +12V, and -12V, and the fifth monitors any desired voltage. The MAX8216 is identical, except it monitors ±15V supplies instead of ±12V. The resistors required to monitor these voltages and provide comparator hysteresis are included on-chip. All comparators have open-drain outputs. These devices consume 250µA max supply current over temperature.

## Applications

Microprocessor Voltage Monitor  
 +5V, -5V, +12V, -12V Supply Monitoring (MAX8215)  
 +5V, -5V, +15V, -15V Supply Monitoring (MAX8216)  
 Overvoltage/Undervoltage Detection with  
 Uncommitted Comparator  
 Industrial Controllers  
 Mobile Radios  
 Portable Instruments  
 Industrial Equipment  
 Data-Acquisition Systems

## Typical Operating Circuit

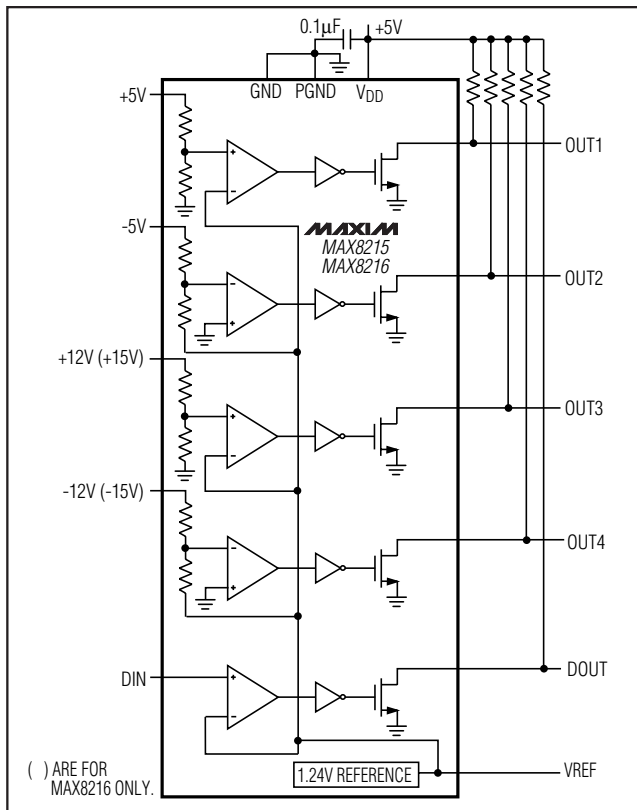

## Features

- ◆ 4 Dedicated Comparators plus 1 Auxiliary Comparator
- ◆ 5V Dedicated Comparator Has ±1.25% Accuracy
- ◆ -5V, +12V, -12V, +15V, -15V Dedicated Comparators Have ±1.5% Accuracy
- ◆ Overvoltage/Undervoltage Detection or Programmable Delay Using Auxiliary Comparator
- ◆ Internal 1.24V Reference with ±1% Initial Accuracy
- ◆ Wide Supply Range: 2.7V to 11V
- ◆ Built-In Hysteresis
- ◆ 250µA Max Supply Current Over Temp.
- ◆ Independent Open-Drain Outputs
- ◆ All Precision Components Included

## Ordering Information

| PART       | TEMP RANGE      | PIN-PACKAGE    |
|------------|-----------------|----------------|
| MAX8215CPD | 0°C to +70°C    | 14 Plastic DIP |
| MAX8215CSD | 0°C to +70°C    | 14 SO          |
| MAX8215C/D | 0°C to +70°C    | Dice*          |
| MAX8215EPD | -40°C to +85°C  | 14 Plastic DIP |
| MAX8215ESD | -40°C to +85°C  | 14 SO          |
| MAX8215EJD | -40°C to +85°C  | 14 CERDIP      |
| MAX8215MPD | -55°C to +125°C | 14 Plastic DIP |
| MAX8215MJD | -55°C to +125°C | 14 CERDIP      |

\*Dice are tested at  $T_A = +25^\circ\text{C}$ .

Devices in PDIP and SO packages are available in both leaded and lead-free packaging. Specify lead free by adding the + symbol at the end of the part number when ordering. Lead free not available for CERDIP package.

Ordering Information continued on last page.

## Pin Configuration

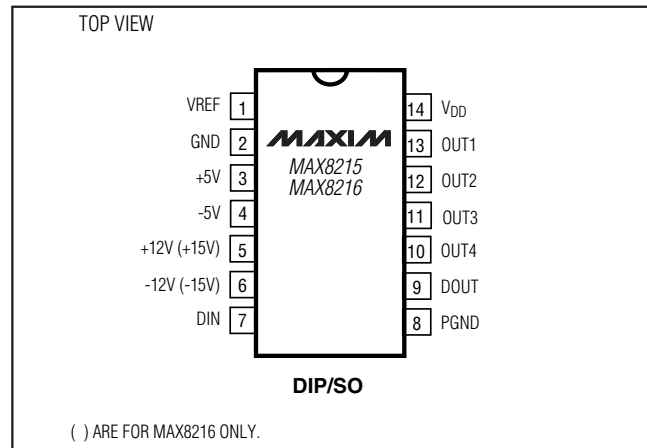

# **±5V, ±12V (±15V) Dedicated Microprocessor Voltage Monitors**

## **ABSOLUTE MAXIMUM RATINGS**

|   |                                 |
|---|---------------------------------|
| V <sub>DD</sub> .....                                 | -0.3V, +12V                     |
| V <sub>REF</sub> .....                                | -0.3V, (V <sub>DD</sub> + 0.3V) |
| OUT_, DOUT Outputs.....                               | -0.3V, (V <sub>DD</sub> + 0.3V) |
| +5V Input.....  | +20V, -0.3V                     |
| -5V, +12V, +15V, -12V, -15V Inputs.....               | ±50V                            |
| DIN Input.....  | (V <sub>DD</sub> + 0.3V), -0.3V |
| Continuous Power Dissipation (T <sub>A</sub> = +70°C) |                                 |
| Plastic DIP (derate 10.00mW/°C above +70°C) .....     | 800mW                           |
| SO (derate 8.33mW/°C above +70°C).....                | 667mW                           |
| CERDIP (derate 9.09mW/°C above +70°C).....            | 727mW                           |

Operating Temperature Ranges:

|  |                 |
|--|-----------------|
| MAX821_C_.....                           | 0°C to +70°C    |
| MAX821_E_.....                           | -40°C to +85°C  |
| MAX821_M_.....                           | -55°C to +125°C |
| Storage Temperature Range .....          | -65°C to +165°C |
| Lead Temperature (soldering, 10sec)..... | +300°C          |

Stresses beyond those listed under "Absolute Maximum Ratings" may cause permanent damage to the device. These are stress ratings only, and functional operation of the device at these or any other conditions beyond those indicated in the operational sections of the specifications is not implied. Exposure to absolute maximum rating conditions for extended periods may affect device reliability.

## **ELECTRICAL CHARACTERISTICS**

(V<sub>DD</sub> = +5V, GND = 0V, T<sub>A</sub> = T<sub>MIN</sub> to T<sub>MAX</sub>, unless otherwise noted.)

| PARAMETER                                     | CONDITIONS  | MIN                     | TYP    | MAX    | UNITS  |   |
|---|---|-------------------------|--------|--------|--------|---|
| <b>POWER SUPPLY</b>                           |   |                         |        |        |        |   |
| V <sub>DD</sub> Supply Voltage Range          | MAX821_C  | 2.7                     |        | 11     | V      |   |
|   | MAX821_E/M  | 2.85                    |        | 11     |        |   |
| I <sub>DD</sub> Supply Current                |   |                         | 137    | 250    | μA     |   |
| <b>REFERENCE OUTPUT</b>                       |   |                         |        |        |        |   |
| Output Voltage Tolerance<br>Referred to 1.24V | T <sub>A</sub> = +25°C  |                         | -1.00  | 1.00   | %      |   |
|   | T <sub>A</sub> = T <sub>MIN</sub> to T <sub>MAX</sub>             | MAX821_C                | -1.5   | 1.5    |        |   |
|   |   | MAX821_E                | -1.75  | 1.75   |        |   |
|   |   | MAX821_M                | -2.5   | 2.5    |        |   |
| Load Current                                  |   |                         |        | 40     | μA     |   |
| Load Regulation                               |   |                         | 3.3    |        | μV/μA  |   |
| Line Regulation                               |   |                         | 0.01   |        | %/V    |   |
| Output Tempco                                 |   |                         | 15     |        | ppm/°C |   |
| <b>COMPARATOR INPUTS</b>                      |   |                         |        |        |        |   |
| +5V Trip Level                                | V <sub>IN</sub> decreasing, T <sub>A</sub> = +25°C                |                         | 4.521  | 4.579  | 4.636  | V |
|   | T <sub>A</sub> = T <sub>MIN</sub> to T <sub>MAX</sub>             | MAX821_C                | 4.500  |        | 4.657  |   |
|   |   | MAX821_E                | 4.500  |        | 4.657  |   |
|   |   | MAX821_M                | 4.464  |        | 4.693  |   |
|   | V <sub>IN</sub> increasing  |                         |        | 4.636  | 4.749  |   |
| +5V Trip Level Hysteresis                     |   | T <sub>A</sub> = +25°C  |        | 1.25   | %      |   |
|   |   | T <sub>A</sub> = +125°C |        | 1.75   |        |   |
|   |   | T <sub>A</sub> = -55°C  |        | 0.8    |        |   |
| +12V Trip Level                               | V <sub>IN</sub> decreasing (MAX8215 only), T <sub>A</sub> = +25°C |                         | 10.431 | 10.590 | 10.749 | V |
|   | T <sub>A</sub> = T <sub>MIN</sub> to T <sub>MAX</sub>             | MAX821_C                | 10.404 |        | 10.775 |   |
|   |   | MAX821_E                | 10.378 |        | 10.802 |   |
|   |   | MAX821_M                | 10.325 |        | 10.855 |   |
| +15V Trip Level                               | V <sub>IN</sub> decreasing (MAX8216 only), T <sub>A</sub> = +25°C |                         | 13.036 | 13.235 | 13.434 | V |
|   | T <sub>A</sub> = T <sub>MIN</sub> to T <sub>MAX</sub>             | MAX821_C                | 13.003 |        | 13.467 |   |
|   |   | MAX821_E                | 12.970 |        | 13.500 |   |
|   |   | MAX821_M                | 12.904 |        | 13.566 |   |

# ±5V, ±12V (±15V) Dedicated Microprocessor Voltage Monitors

**MAX8215/MAX8216**

## ELECTRICAL CHARACTERISTICS (continued)

(V<sub>DD</sub> = +5V, GND = 0V, T<sub>A</sub> = T<sub>MIN</sub> to T<sub>MAX</sub>, unless otherwise noted.)

| PARAMETER                                  | CONDITIONS  | MIN                    | TYP     | MAX     | UNITS |
|--|---|------------------------|---------|---------|-------|
| -12V Trip Level                            | V <sub>IN</sub>   decreasing, T <sub>A</sub> = +25°C                | -10.431                | -10.590 | -10.749 | V     |
|  | T <sub>A</sub> = T <sub>MIN</sub> to T <sub>MAX</sub>               | MAX821_C               | -10.404 | -10.776 |       |
|  |   | MAX821_E               | -10.378 | -10.802 |       |
|  |   | MAX821_M               | -10.325 | -10.855 |       |
| -15V Trip Level                            | V <sub>IN</sub>   decreasing (MAX8216 only), T <sub>A</sub> = +25°C | -13.036                | -13.235 | -13.434 | V     |
|  | T <sub>A</sub> = T <sub>MIN</sub> to T <sub>MAX</sub>               | MAX821_C               | -13.003 | -13.467 |       |
|  |   | MAX821_E               | -12.970 | -13.500 |       |
|  |   | MAX821_M               | -12.904 | -13.566 |       |
| -5V Trip Level                             | V <sub>IN</sub>   decreasing, T <sub>A</sub> = +25°C                | -4.348                 | -4.415  | -4.482  | V     |
|  | T <sub>A</sub> = T <sub>MIN</sub> to T <sub>MAX</sub>               | MAX821_C               | -4.337  | -4.493  |       |
|  |   | MAX821_E               | -4.326  | -4.500  |       |
|  |   | MAX821_M               | -4.304  | -4.525  |       |
| Threshold Hysteresis                       | T <sub>A</sub> = +25°C  | +15V trip level        | 1.25    | 2.00    | %     |
|  |   | +12V trip level        | 1.25    | 2.00    |       |
|  |   | -15V trip level        | 1.50    | 2.25    |       |
|  |   | -12V trip level        | 1.50    | 2.25    |       |
|  |   | -5V trip level         | 1.60    | 2.25    |       |
| Hysteresis Tempco, ±15, ±12, -5            |   |                        | 0.005   |         | %/°C  |
| Input Resistance                           | T <sub>A</sub> = +25°C  | +5V input to GND       | 130     |         | kΩ    |
|  |   | +12V/+15V input to GND | 168     |         |       |
|  |   | -5V input to REF       | 160     |         |       |
|  |   | -12V/-15V input to REF | 190     |         |       |
| <b>AUXILIARY COMPARATOR INPUT</b>          |   |                        |         |         |       |
| Trip Level with Respect to 1.24V           | V <sub>IN</sub> decreasing, T <sub>A</sub> = +25°C                  | -1.5                   | 0       | 1.5     | %     |
|  |   | MAX821_C               | -1.75   | 1.75    |       |
|  |   | MAX821_E               | -2.00   | 2.00    |       |
|  |   | MAX821_M               | -2.50   | 2.50    |       |
| Threshold Hysteresis                       | T <sub>A</sub> = +25°C  |                        | 1.25    | 2.00    | %     |
| Input Bias Current                         | T <sub>A</sub> = +25°C  |                        | 2       | 10      | nA    |
| Voltage Output Low                         | V <sub>OL</sub> ; V <sub>DD</sub> = 5V, I <sub>SINK</sub> = 2mA     |                        | 0.11    | 0.3     | V     |
|  | V <sub>DD</sub> = 1.5V, I <sub>SINK</sub> = 0.2mA                   |                        | 0.04    | 0.3     |       |
|  | V <sub>DD</sub> = 1.0V, I <sub>SINK</sub> = 0.1mA                   |                        | 0.10    |         |       |
| Leakage Current                            | Off State   |                        |         | 1.0     | μA    |
| Comparator Response Time (All Comparators) | 30mV overdrive (Note 1)   |                        | 20      |         | μs    |

**Note 1:** To overdrive the +5V/+12V/+15V comparators with a 30mV overdrive voltage, use the formula  $30\text{mV} \left( \frac{V_{\text{THR}}}{1.24} \right)$  to determine the required input voltage. V<sub>THR</sub> is the threshold of the particular overdriven comparator. To overdrive the -5V/-12V/-15V comparators use  $30\text{mV} \left[ 1 + \left| \frac{V_{\text{THR}}}{1.24} \right| \right]$ .

# ±5V, ±12V (±15V) Dedicated Microprocessor Voltage Monitors

## Typical Operating Characteristics

( $T_A = +25^\circ\text{C}$ , unless otherwise noted.)

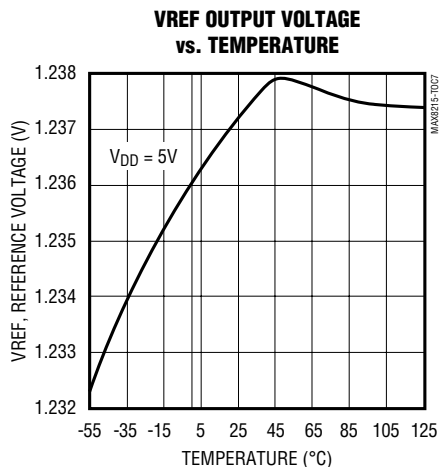
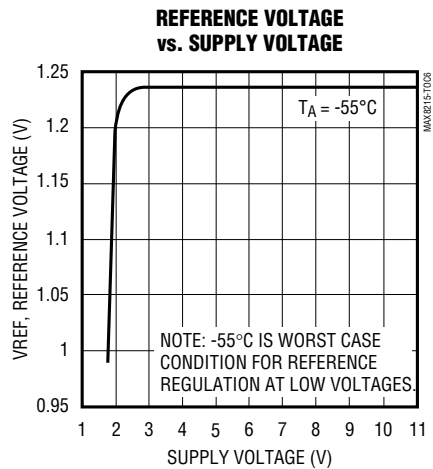
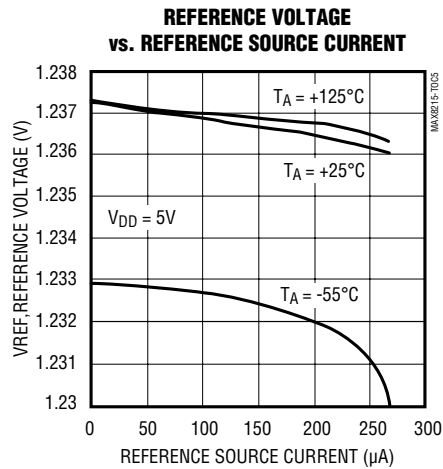
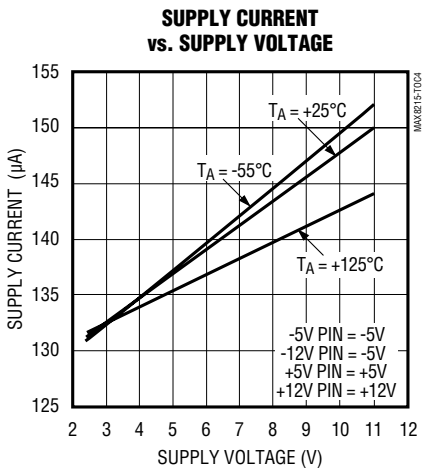
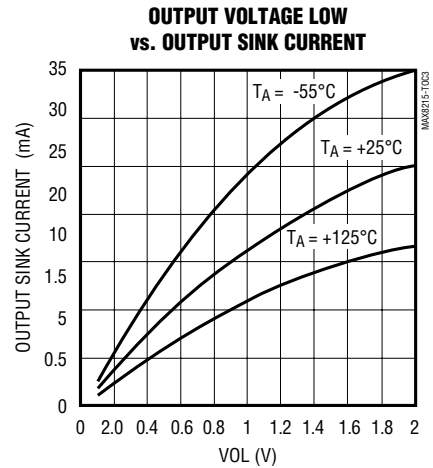
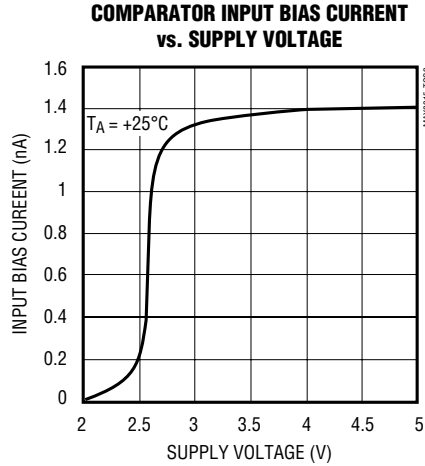
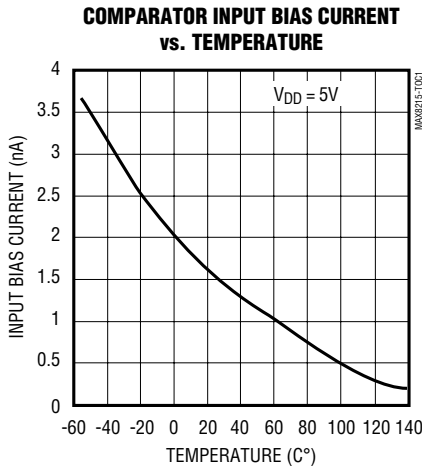

# ±5V, ±12V (±15V) Dedicated Microprocessor Voltage Monitors

MAX8215/MAX8216

## Typical Operating Characteristics (continued)

( $T_A = +25^\circ\text{C}$ , unless otherwise noted.)

**+5V RESPONSE WITH ±100mV INPUT EXCURSION AROUND TRIP LEVEL**

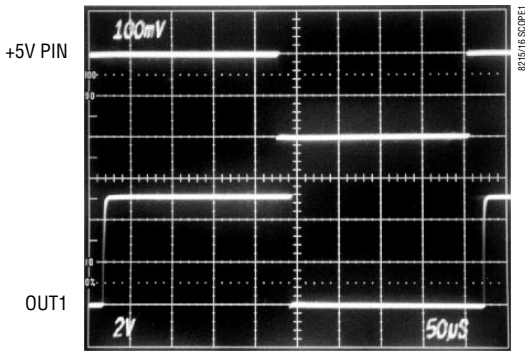

+5V COMP

**-5V RESPONSE WITH ±100mV INPUT EXCURSION AROUND TRIP LEVEL**

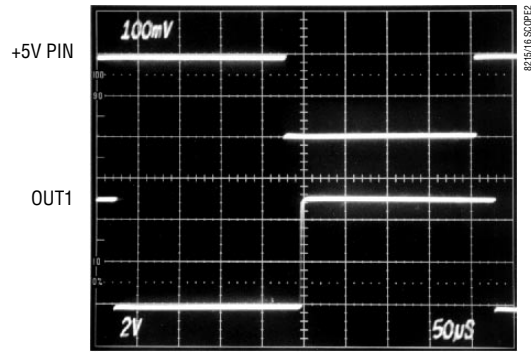

-5V COMP

**DOUT OUTPUT VOLTAGE vs. SUPPLY VOLTAGE**  
R1 = 15kΩ, R2 = 40k (see Figure 4)

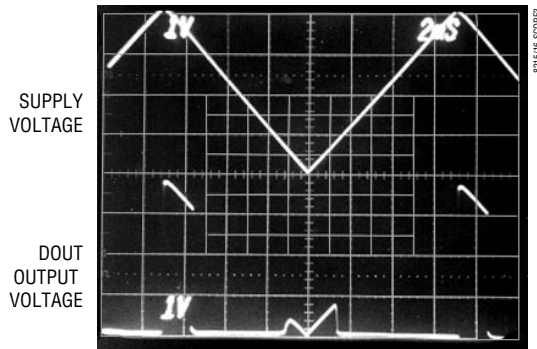

**DIN COMPARATOR RESPONSE WITH 30mV OVERDRIVE**

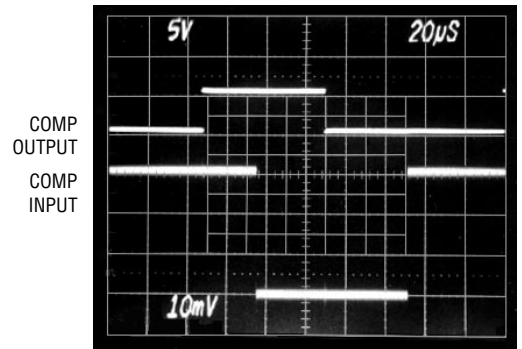

**DIN COMPARATOR RESPONSE WITH 50mV OVERDRIVE**

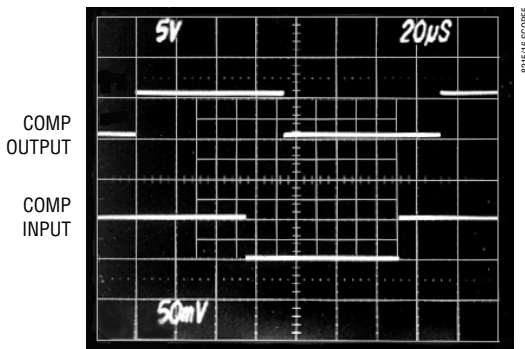

**DIN COMPARATOR RESPONSE WITH 100mV OVERDRIVE**

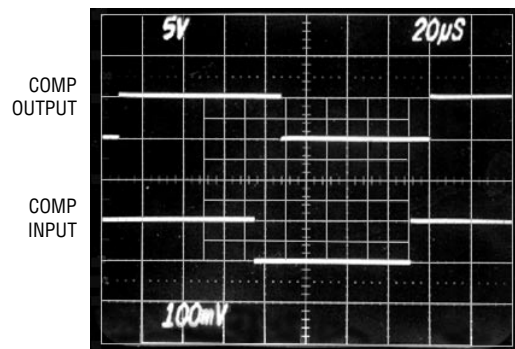

# $\pm 5V$ , $\pm 12V$ ( $\pm 15V$ ) Dedicated Microprocessor Voltage Monitors

## Pin Description

| PIN               | NAME                            | FUNCTION   |
|-------------------|---------------------------------|--|
| 1                 | VREF                            | Output of the internal 1.24V reference   |
| 2                 | GND                             | Ground. Connect to PGND.   |
| 3                 | +5V                             | Input for monitoring +5V supply  |
| 4                 | -5V                             | Input for monitoring -5V supply  |
| 5                 | +12V<br>(+15V)                  | MAX8215 input for monitoring +12V<br>(MAX8216 input for monitoring +15V)                               |
| 6                 | -12V<br>(-15V)                  | MAX8215 input for monitoring -12V<br>(MAX8216 input for monitoring -15V)                               |
| 7                 | DIN                             | Noninverting input of the auxiliary comparator. Its inverting input is tied to the internal reference. |
| 8                 | PGND                            | Power-supply ground. Bypass $V_{DD}$ to this pin.  |
| 9                 | DOUT                            | Output of the auxiliary comparator   |
| 10, 11,<br>12, 13 | OUT4,<br>OUT3,<br>OUT2,<br>OUT1 | Outputs of the four dedicated comparators  |
| 14                | $V_{DD}$                        | Power-supply positive voltage input. Bypass to PGND.   |

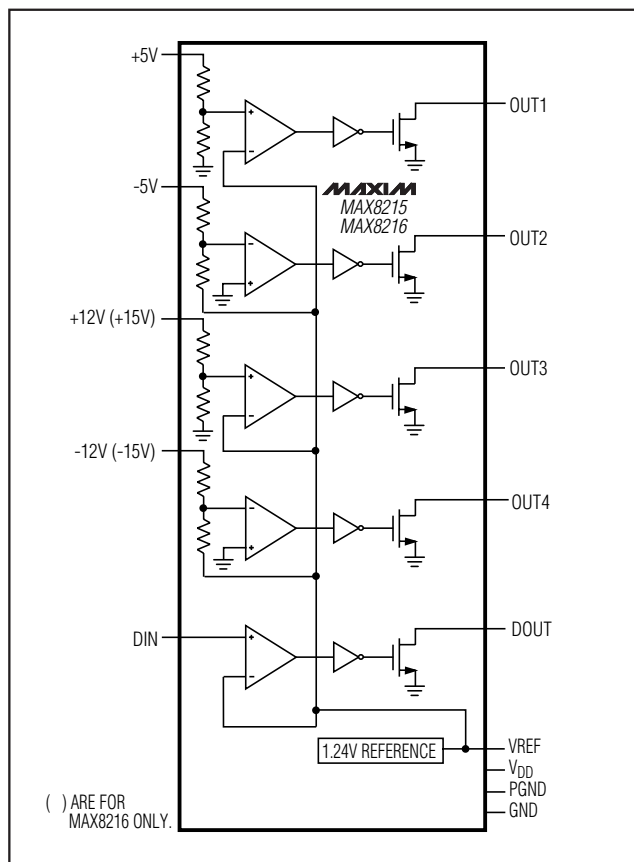

Figure 1. Block Diagram

## Detailed Description

The MAX8215/MAX8216 contain 5 comparators (Figure 1). The comparator with its output labeled DOUT is distinguished from the others in that it can be set up to monitor various voltages; each of the other 4 comparators monitors a specific voltage. The DOUT comparator's noninverting input is available external to the device; its inverting input is tied internally to the reference.

The MAX8215/MAX8216 comparators have open-drain outputs. Thus, these devices require pull-up resistors for proper operation. See the *Typical Operating Circuit*. Open-drain outputs are useful for driving LEDs and for situations in which the comparator outputs must be connected together (i.e., wire-ORed).

Bypass  $V_{DD}$  with 0.1 $\mu$ F connected to PGND.

## Applications Information

### Hysteresis

When the voltage on a typical comparator's input is at or near the voltage on the other input, ambient noise generally causes the comparator output to oscillate. The most common way to eliminate this problem is by using hysteresis. When the two comparator input voltages are equal, hysteresis causes one comparator input voltage to move quickly past the other, thus taking the input out of the region where oscillation occurs. Standard comparators need external resistors for hysteresis; these resistors are not necessary when using any of the MAX8215 and MAX8216 comparators because hysteresis is built in.

# ±5V, ±12V (±15V) Dedicated Microprocessor Voltage Monitors

MAX8215/MAX8216

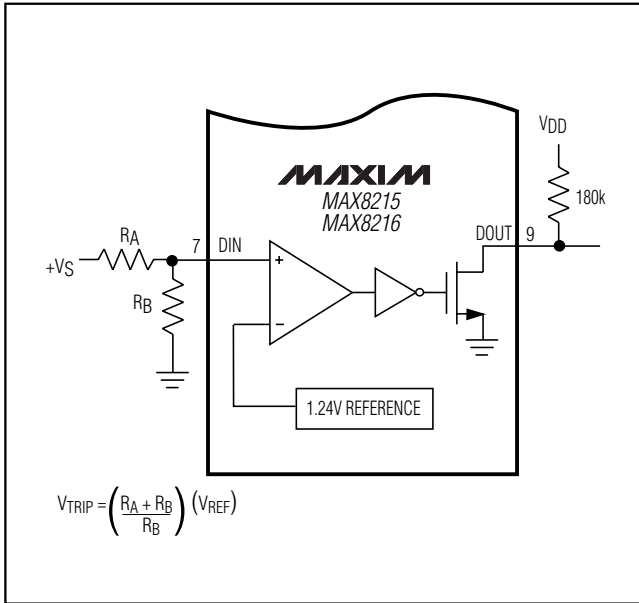

Figure 2. Undervoltage/Overvoltage Comparator Using the Auxiliary Comparator

Adding hysteresis to a comparator creates two trip points—one for the input voltage rising and one for the input voltage falling. When the voltage at the MAX8215/MAX8216 auxiliary comparator's (noninverting) input falls, the threshold at which the comparator switches equals the reference voltage connected to the comparator's inverting input. However, when the voltage at the noninverting input rises, the threshold equals the reference voltage **plus** the amount of hysteresis voltage built into the part. The trip point is somewhat more accurate when the hysteresis voltage is not part of the threshold voltage (i.e., when the input voltage is falling) because the tolerance of the hysteresis specification adds to the tolerance of the trip point.

### Overvoltage and Undervoltage Detection Circuits

Figure 2 shows connection of the auxiliary comparator as either an undervoltage or overvoltage comparator. Hysteresis makes this circuit more accurate when the input voltage is dropping as opposed to rising. Figure 3 illustrates the comparator's operation. The input voltage's direction determines at which of two trip points the comparator switches. Thus, the diagram includes arrows that indicate whether the input voltage is rising or falling. The formulas are provided for determining trip-point voltages for specified resistors and for ease in calculating appropriate resistor ratios for particular trip points.

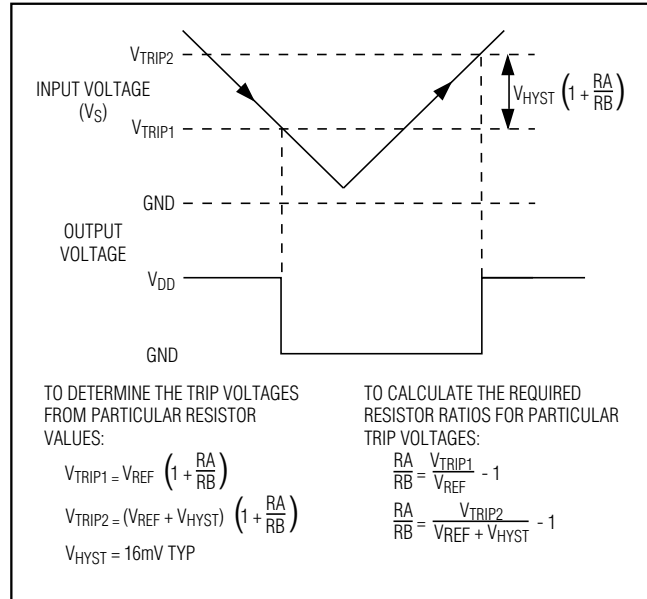

Figure 3. Undervoltage/Overvoltage Detector Waveforms and Formulas

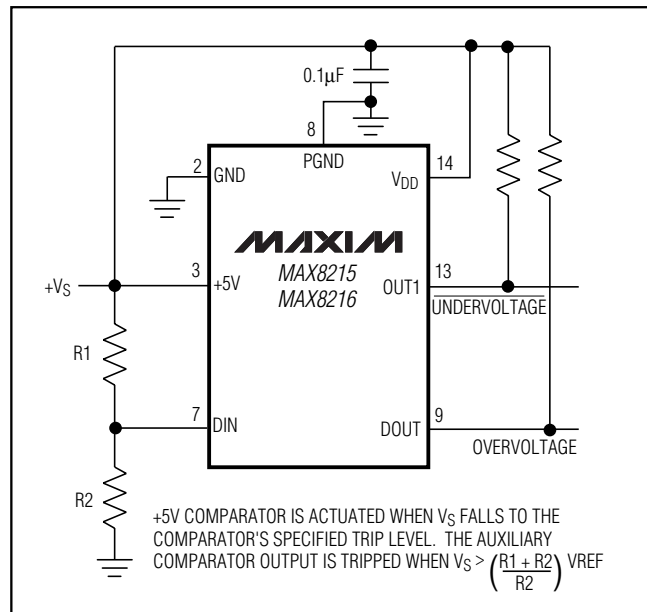

Figure 4. Monitoring Supply Powering the MAX8215/MAX8216 with Undervoltage and Overvoltage Comparators

The MAX8215/MAX8216 comparator outputs correctly display a low level down to 0.8V supply voltage. This is useful in undervoltage applications where the monitored power supply is also the supply connected to the VDD pin. See the section *Monitoring the Supply Voltage*.

## ±5V, ±12V (±15V) Dedicated Microprocessor Voltage Monitors

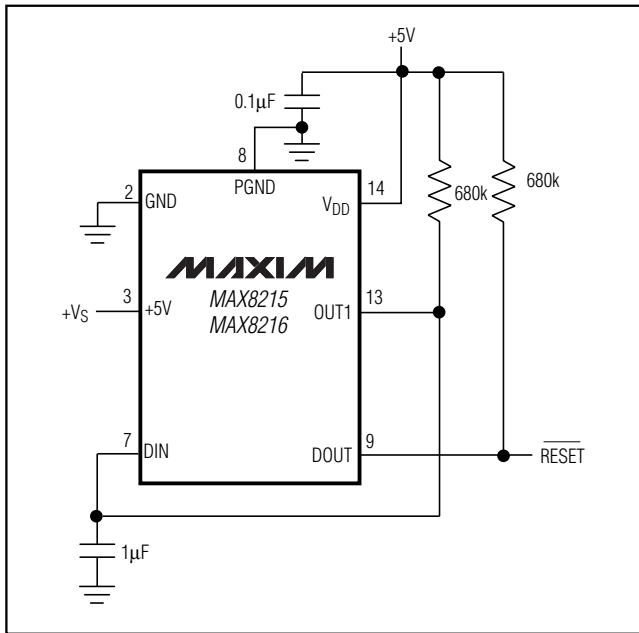

Figure 5. Microprocessor Reset Circuit with 200ms Time Delay

### Monitoring the Supply Voltage

The supply voltage to these devices can also be monitored by the 5V dedicated comparator and the auxiliary comparator. Figure 4 shows a circuit that monitors the voltage connected at  $V_{DD}$  for both overvoltage and undervoltage conditions. The +5V comparator checks for undervoltage conditions while the auxiliary comparator monitors overvoltage conditions. In general, no extra supply bypassing circuitry (other than the normally recommended 0.1µF capacitor) is required when performing this function. However, using resistor values higher than 100kΩ at the auxiliary comparator's input requires attention to eliminate potential oscillations. Also, particularly low pull-up resistor values on DOUT contribute to the likelihood of the auxiliary comparator's oscillation. See the section *Eliminating Output Oscillation*.

### Microprocessor Reset Circuit with Time Delay

It is often necessary to reset a microprocessor (µP) when its supply voltage drops below a certain level. Figure 5's circuit generates a low output when the monitored voltage drops below the 5V monitor's threshold. Additionally, this output remains low for 200ms after the supply voltage goes above the threshold. µP reset circuits typically include this feature because it gives the µP time to be fully reset after power has been restored, and allows any capacitors in associated circuitry time to charge. Figure 6 shows this circuit's waveforms and formulas.

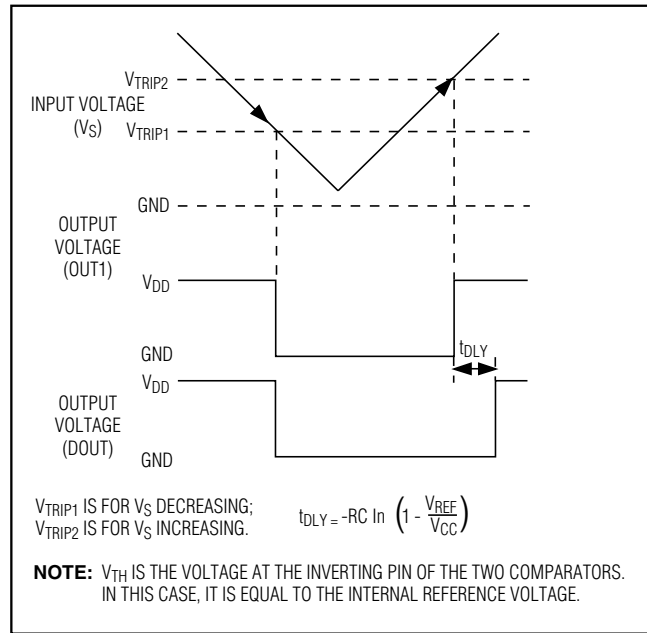

Figure 6. Microprocessor Reset with Time Delay Waveforms

Figure 7 shows Figure 5's µP reset circuit, but with the monitored supply also powering the MAX8215. Figure 6's waveforms and equations also apply to this circuit.

The MAX8215/MAX8216 comparator outputs correctly display a low level down to a 0.8V typical supply voltage.

### Unused Inputs

When the uncommitted comparator within the MAX8215/MAX8216 is not used, tie the unused input to either the positive supply or ground. This prevents noise generation due to the comparator output switching from one logic state to another (due to noise at the input).

### Output Pull-Up Resistors

Pull-up resistors are required at the outputs of each comparator. Resistor values should not be less than 2.7kΩ if the outputs are pulled up to  $V_{DD}$ . In general, save power by using higher values, e.g., ≥100kΩ. Use of higher-value resistors also minimizes the possibility of oscillations due to a spurious feedback (see the section *Eliminating Output Oscillation*).

### Input Voltage Limitation

If the voltages at the various inputs are kept within the absolute maximum ratings, the device is not damaged. However, high input voltages within this range can cause the reference voltage to move. To prevent the reference voltage from changing, limit the +5V input to +17V; the -5V and -15V inputs to +1V; and the +15V input to +60V. Negative input voltages within the

# **$\pm 5V$ , $\pm 12V$ ( $\pm 15V$ ) Dedicated Microprocessor Voltage Monitors**

**MAX8215/MAX8216**

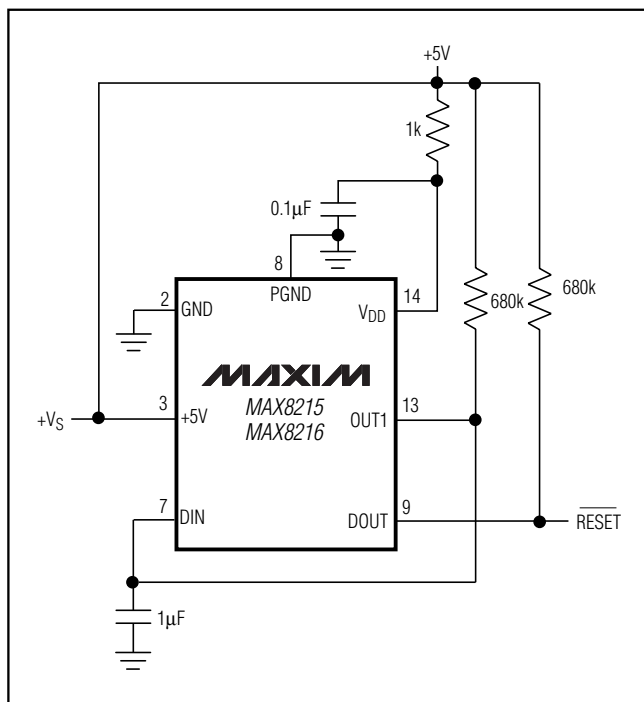

Figure 7. Microprocessor Reset Circuit Monitoring Its Own Supply Voltage

absolute maximum ratings have no effect on the reference. Within the absolute maximum ratings, the DIN input has no effect on the reference.

### **Power-Supply Bypassing and Grounding**

In high-noise environments where the voltage connected to  $V_{DD}$  may change abruptly, the reference voltage may "bounce," causing false comparator outputs. Eliminate this problem using Figure 8's RC bypass network.

Although bypassing the reference may appear to help, Figure 8's solution is recommended; bypassing the reference reduces its voltage change, but doing so causes a time delay prior to the reference voltage returning to its correct level.

### **Eliminating Output Oscillation when Using the Auxiliary Comparator**

Although hysteresis is built into the auxiliary comparator, output oscillation problems are still possible. Oscillation can occur when a comparator's output couples back to its inverting input through stray board capacitance. Make sure the board trace leading from the comparator output does not pass near its inverting input (or vice versa). Also, reducing the resistance connected to DIN reduces its susceptibility to picking up output signals. In

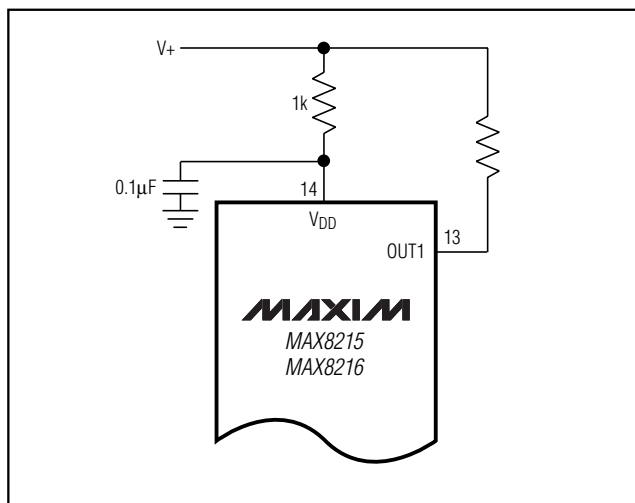

Figure 8. Alternate Bypass Scheme

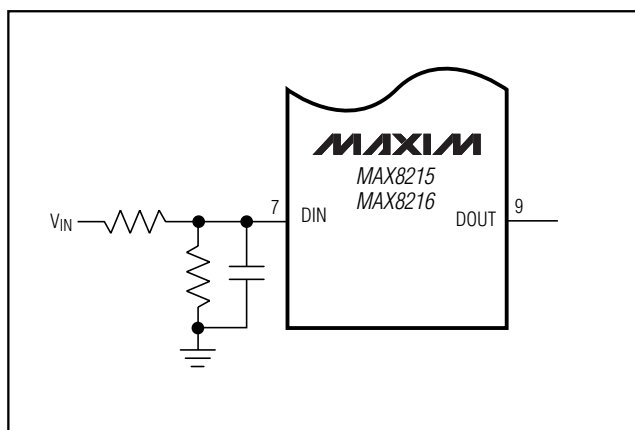

Figure 9. Alternative Means for Reducing Impedance Level Seen at DIN

most cases, using input resistor values on the order of  $100k\Omega$  creates no problem. Since using lower resistor values increases the supply current, another approach is to bypass the input resistors as shown in Figure 9, although this slows the circuit's response. When much larger valued input resistors are used, high valued resistors on the output should be used.

When DOUT is required to sink larger currents (i.e., when smaller pull-up resistor values are used), oscillation problems are more likely to occur. To minimize power consumption and to optimize stability, use the largest value pull-up resistor feasible for the output drive required. When lower pull-up resistor values are used, lower values for the resistors connected to the inputs can help alleviate oscillation problems.

# **±5V, ±12V (±15V) Dedicated Microprocessor Voltage Monitors**

## **Ordering Information (continued)**

| PART       | TEMP. RANGE     | PIN-PACKAGE    |
|------------|-----------------|----------------|
| MAX8216CPD | 0°C to +70°C    | 14 Plastic DIP |
| MAX8216CSD | 0°C to +70°C    | 14 SO          |
| MAX8216C/D | 0°C to +70°C    | Dice*          |
| MAX8216EPD | -40°C to +85°C  | 14 Plastic DIP |
| MAX8216ESD | -40°C to +85°C  | 14 SO          |
| MAX8216EJD | -40°C to +85°C  | 14 CERDIP      |
| MAX8216MPD | -55°C to +125°C | 14 Plastic DIP |
| MAX8216MJD | -55°C to +125°C | 14 CERDIP      |

\* Dice are tested at  $T_A = +25^\circ\text{C}$ .

## **Chip Topography**

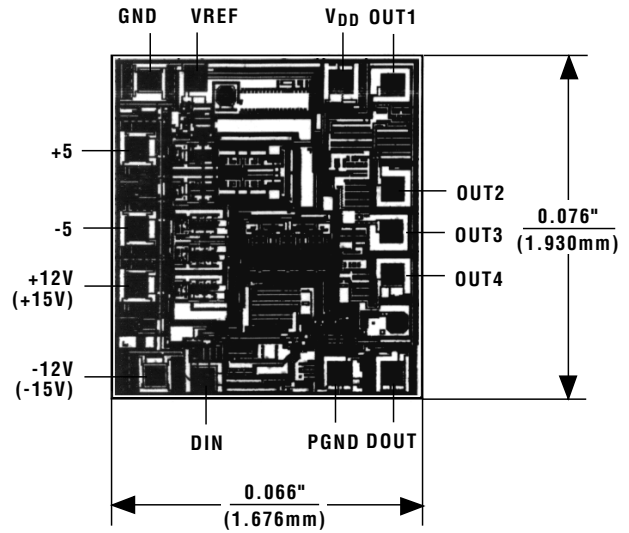

( ) ARE FOR MAX8216 ONLY.  
 TRANSISTOR COUNT: 275;  
 SUBSTRATE CONNECTED TO  $V_{DD}$ .

# ±5V, ±12V (±15V) Dedicated Microprocessor Voltage Monitors

## Package Information

**MAX8215/MAX8216**

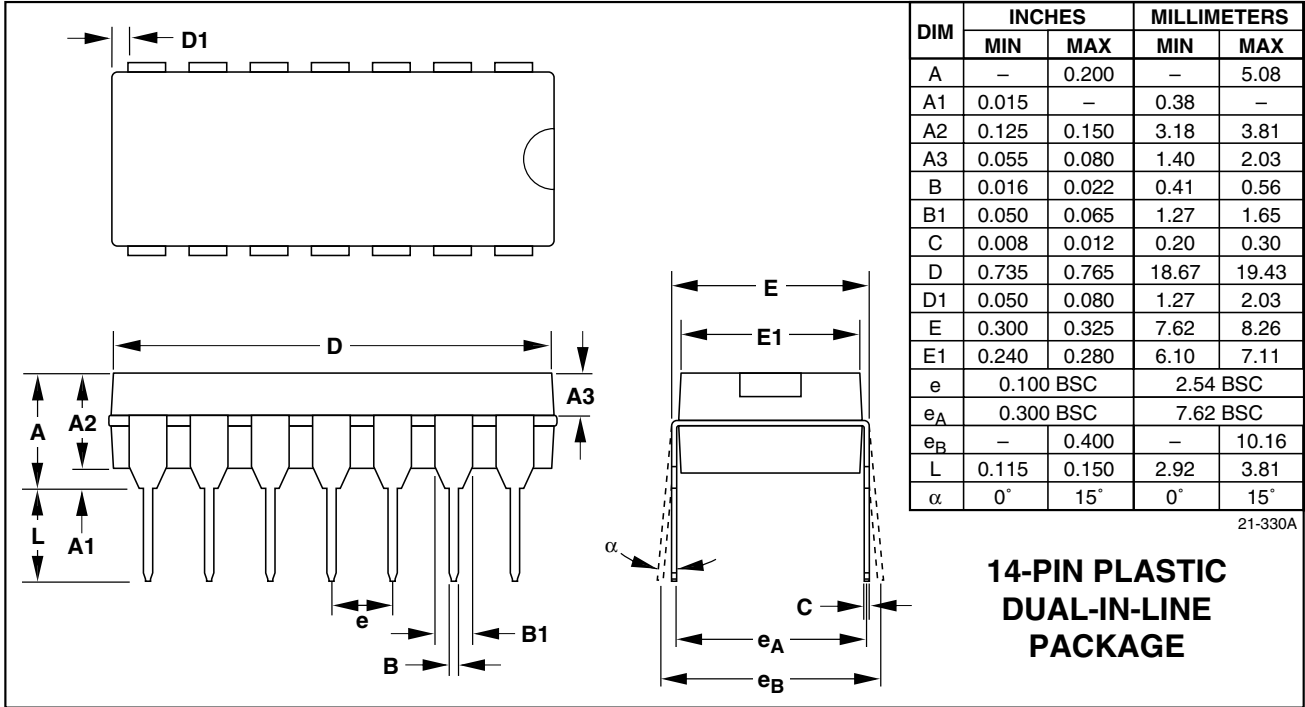

# ±5V, ±12V (±15V) Dedicated Microprocessor Voltage Monitors

## Package Information (continued)

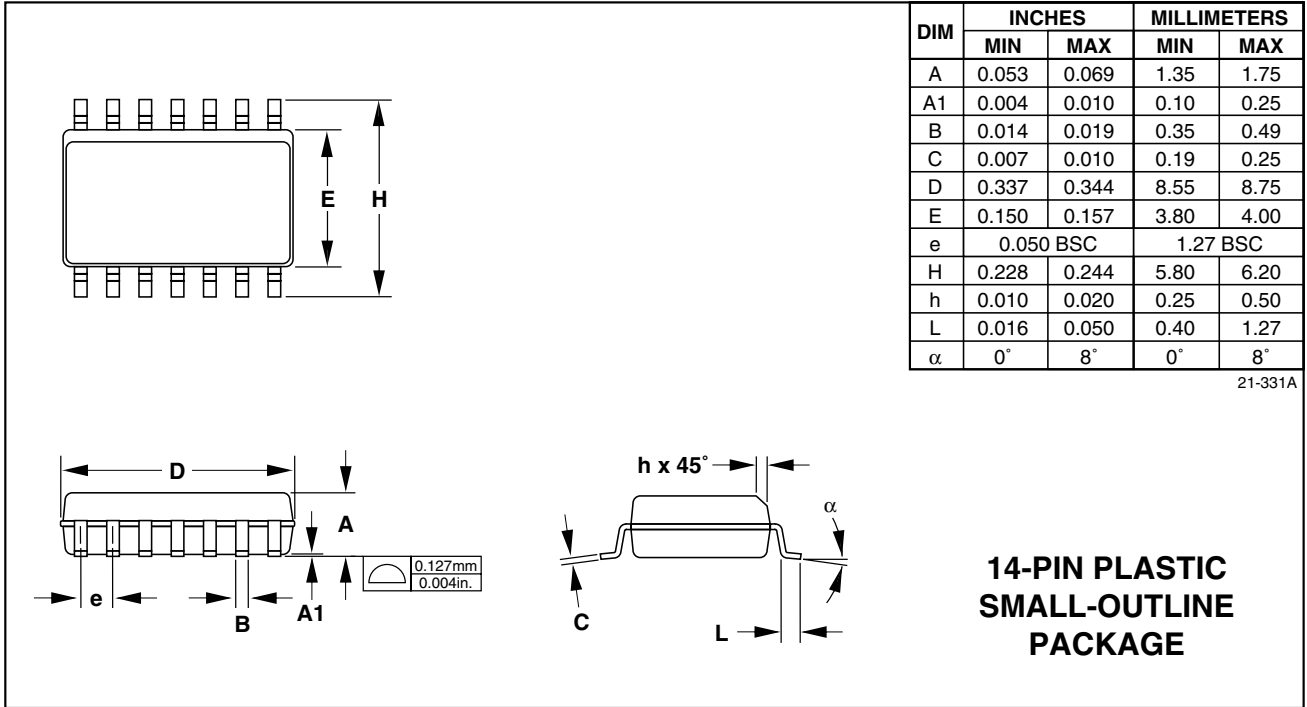



Maxim cannot assume responsibility for use of any circuitry other than circuitry entirely embodied in a Maxim product. No circuit patent licenses are implied. Maxim reserves the right to change the circuitry and specifications without notice at any time.

12 \_\_\_\_\_ **Maxim Integrated Products, 120 San Gabriel Drive, Sunnyvale, CA 94086 (408) 737-7600**

## Looking for pricing, stock, or lifecycle information?

Click below to explore more details on WIN SOURCE:

-  View [MAX8215ESD-T](#) on WIN SOURCE
-  [Maxim Integrated](#) Information

## Optimize Your Supply Chain with WIN SOURCE Solutions

-  Global Sourcing Solution
-  Obsolete Management
-  Cost Control Management
-  Shortage Management
-  Alternative Solution
-  Excess Inventory Management