



**THE DATASHEET OF  
MAX709TCSA+T**





## Power-Supply Monitor with Reset

MAX709

### General Description

The MAX709 provides a system reset during power-up, power-down, and brownout conditions. When  $V_{CC}$  falls below the reset threshold, RESET goes low and holds the  $\mu P$  in reset for 140ms min after  $V_{CC}$  rises above the threshold.

The RESET output is guaranteed to be in the correct state with  $V_{CC}$  down to 1V. The MAX709 provides excellent circuit reliability and low cost by eliminating external components and adjustments when used with +5V, +3.3V, or +3V powered systems. The MAX709 is available 8-pin DIP,  $\mu$ MAX, and SO packages.

### Applications

Minimum Component Count,  
Low-Cost Processor Systems

### Typical Operating Circuit

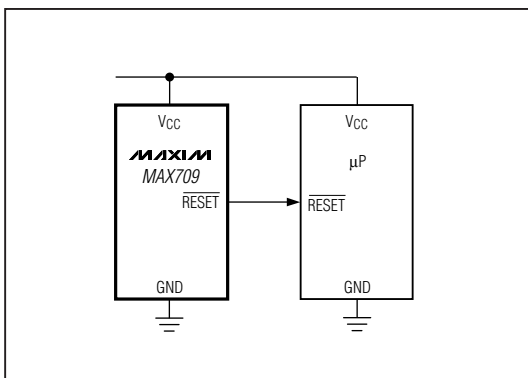

### Features

- ◆ +5V, +3.3V, and +3V Versions
- ◆ No External Components
- ◆ Low Cost
- ◆ Precise Power-Down Reset Threshold
- ◆ 140ms Min Power-On Reset Delay
- ◆ Immune to Short Negative  $V_{CC}$  Transients
- ◆ 8-Pin DIP,  $\mu$ MAX, and SO Packages
- ◆ Low Supply Current: 35 $\mu$ A - MAX709R/S/T  
65 $\mu$ A - MAX709L/M

### Ordering Information

PART	TEMP. RANGE	PIN-PACKAGE
MAX709_CPA	0°C to +70°C	8 Plastic DIP
MAX709_CUA	0°C to +70°C	8 $\mu$ MAX
MAX709_CSA	0°C to +70°C	8 SO
MAX709_C/D	0°C to +70°C	Dice
MAX709_EPA	-40°C to +85°C	8 Plastic DIP
MAX709_EUA	-40°C to +85°C	8 $\mu$ MAX
MAX709_ESA	-40°C to +85°C	8 SO

Devices are available in both leaded and lead-free packaging. Specify lead free by adding the + symbol at the end of the part number when ordering.

\*Dice are specified at  $T_A = +25^\circ\text{C}$ , DC parameters only.

**Note:** This part offers a choice of five different reset threshold voltages. Select the letter corresponding to the desired nominal reset threshold voltage, and insert it into the blank to complete the part number.

RESET THRESHOLD	
SUFFIX	VOLTAGE (V)
L	4.65
M	4.40
T	3.08
S	2.93
R	2.63

### Pin Configuration

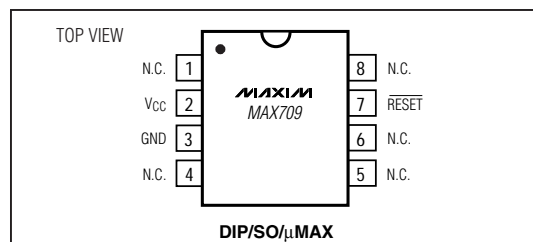

Maxim Integrated Products 1

Call toll free 1-800-998-8800 for free samples or literature.

# Power-Supply Monitor with Reset

**MAX709**

## ABSOLUTE MAXIMUM RATINGS

Terminal Voltage (with respect to GND)	
V <sub>CC</sub> .....	-0.3V to 6.0V
RESET.....	-0.3V to (V <sub>CC</sub> + 0.3V)
Input Current, V <sub>CC</sub> .....	20mA
Output Current, RESET.....	20mA
Rate-of-Rise, V <sub>CC</sub> .....	100V/μs
Continuous Power Dissipation (T <sub>A</sub> = +70°C)	
Plastic DIP (derate 9.09mW/°C above +70°C).....	727mW
μMAX (derate 4.10mW/°C above +70°C).....	330mW
SO (derate 5.88mW/°C above +70°C).....	471mW

Operating Temperature Ranges	
MAX709_C.....	0°C to +70°C
MAX709_E.....	-40°C to +85°C
Storage Temperature Range.....	-65°C to +160°C
Lead Temperature (soldering, 10sec).....	+300°C

Stresses beyond those listed under "Absolute Maximum Ratings" may cause permanent damage to the device. These are stress ratings only, and functional operation of the device at these or any other conditions beyond those indicated in the operational sections of the specifications is not implied. Exposure to absolute maximum rating conditions for extended periods may affect device reliability.

## ELECTRICAL CHARACTERISTICS

(V<sub>CC</sub> = full range, T<sub>A</sub> = T<sub>MIN</sub> to T<sub>MAX</sub>, unless otherwise noted.)

PARAMETER	CONDITIONS	MIN	TYP	MAX	UNITS
V <sub>CC</sub> Range	MAX709_C	1.0		5.5	V
	MAX709_E	1.2		5.5	
Supply Current (Note 1)	MAX709R/S/T only	MAX709_C, V <sub>CC</sub> < 3.6V	35	85	μA
		MAX709_E, V <sub>CC</sub> < 3.6V	35	110	
	All versions	MAX709_C, V <sub>CC</sub> < 5.5V	65	150	
		MAX709_E, V <sub>CC</sub> < 5.5V	65	200	
RESET Threshold, V <sub>TH</sub>	MAX709L	4.50	4.65	4.75	V
	MAX709M	4.25	4.40	4.50	
	MAX709T	3.00	3.08	3.15	
	MAX709S	2.85	2.93	3.00	
	MAX709R	2.55	2.63	2.70	
V <sub>CC</sub> to RESET Delay	V <sub>CC</sub> = reset threshold max to reset threshold min		20		μs
Reset Active Timeout Period	V <sub>CC</sub> = reset threshold max, V <sub>CC</sub> rising	140	280	560	ms
RESET Output Voltage	I <sub>SINK</sub> = 1.2mA, V <sub>CC</sub> = reset threshold min, MAX709R/S/T only			0.3	V
	I <sub>SINK</sub> = 3.2mA, V <sub>CC</sub> = reset threshold min, MAX709L/M only			0.4	
	I <sub>SINK</sub> = 50μA, V <sub>CC</sub> ≥ 1.0V, MAX709_C			0.3	
	I <sub>SINK</sub> = 100μA, V <sub>CC</sub> ≥ 1.2V, MAX709_E			0.4	
	I <sub>SOURCE</sub> = 500μA, V <sub>CC</sub> ≥ reset threshold max, MAX709R/S/T only	0.8 x V <sub>CC</sub>			
	I <sub>SOURCE</sub> = 800μA, V <sub>CC</sub> ≥ reset threshold max, MAX709L/M only	V <sub>CC</sub> - 1.5			

**Note 1:** Supply current is measured with V<sub>CC</sub> = 3.6V for MAX709R/S/T, and V<sub>CC</sub> = 5.5V for all versions.

# Power-Supply Monitor with Reset

## Typical Operating Characteristics

**MAX709**

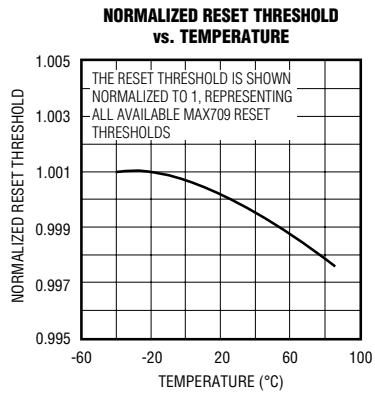
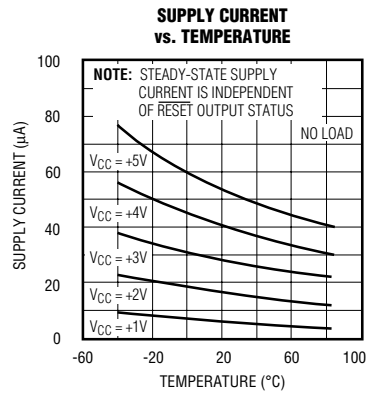
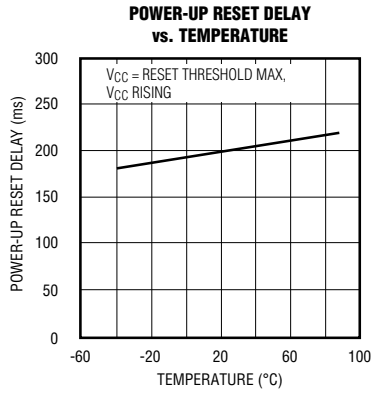

## Power-Supply Monitor with Reset

### Pin Description

PIN	NAME	FUNCTION
1, 4, 5, 6, 8	N.C.	No Connect. There is no internal connection to this pin.
2	V <sub>CC</sub>	+5V, +3.3V, or +3V Supply Voltage
3	GND	Ground
7	RESET	Reset Output remains low while V <sub>CC</sub> is below the reset threshold, and for 280ms after V <sub>CC</sub> rises above the reset threshold.

### Applications Information

#### Negative-Going V<sub>CC</sub> Transients

In addition to issuing a reset to the microprocessor ( $\mu$ P) during power-up, power-down, and brownout conditions, the MAX709 is relatively immune to short duration negative-going V<sub>CC</sub> transients (glitches).

Figure 1 shows typical transient duration vs. reset comparator overdrive, for which the MAX709 does not generate a reset pulse. The graph was generated using a negative-going pulse applied to V<sub>CC</sub>, starting 1.5V above the actual reset threshold and ending below it by the magnitude indicated (reset comparator overdrive). The graph indicates the typical maximum pulse width that a negative-going V<sub>CC</sub> transient may have without causing a reset pulse to be issued. As the magnitude of the transient increases (goes farther below the reset threshold), the maximum allowable pulse width decreases. Typically, for the MAX709L/MAX709M, a V<sub>CC</sub> transient that goes 100mV below the reset threshold and lasts 40 $\mu$ s or less will not cause a reset pulse to be issued.

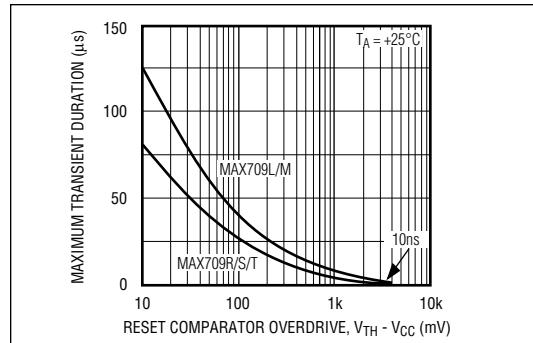

Figure 1. Maximum Transient Duration without Causing a Reset Pulse vs. Reset Comparator Overdrive

A 0.1 $\mu$ F bypass capacitor mounted as close as possible to pin 2 (V<sub>CC</sub>) provides additional transient immunity.

#### Ensuring a Valid RESET Output Down to V<sub>CC</sub> = 0V

When V<sub>CC</sub> falls below 1V, the MAX709 RESET output no longer sinks current—it becomes an open circuit. Therefore, high-impedance CMOS logic inputs connected to the RESET output can drift to undetermined voltages. This presents no problem in most applications, since most  $\mu$ P and other circuitry is inoperative with V<sub>CC</sub> below 1V. However, in applications where the RESET output must be valid down to 0V, adding a pull-down resistor to the RESET pin will cause any stray leakage currents to flow to ground, holding RESET low (see Figure 2). The resistance value of R1 is not critical. It should be about 100k $\Omega$ , which is large enough not to load RESET and small enough to pull RESET to ground.

## Power-Supply Monitor with Reset



Figure 2. RESET Valid to  $V_{CC} = \text{Ground}$  Circuit



Figure 3. Interfacing to  $\mu\text{Ps}$  with Bidirectional Reset I/O

### Interfacing to $\mu\text{Ps}$ with Bidirectional Reset Pins

Microprocessors with bidirectional reset pins (such as the Motorola 68HC11 series) can contend with the MAX709 RESET output. If, for example the MAX709 RESET output is asserted high and the  $\mu\text{P}$  wants to pull it low, indeterminate logic levels may result. To correct this, connect a  $4.7\text{k}\Omega$  resistor between the MAX709 RESET output and the  $\mu\text{P}$  reset I/O (see Figure 3). Buffer the MAX709 RESET output to other system components.

MAX709

# Power-Supply Monitor with Reset

**MAX709**

## μP Supervisory Circuits

Part Number	Nominal Reset Threshold (V)	Minimum Reset Pulse Width (ms)	Nominal Watchdog Timeout Period (sec)	Backup-Battery Switch	CE - Write Protect	Power-Fail Com-parator	Manual-Reset Input	Watch-dog Output	Low-Line Output	Active-High Reset	Battery-On Output
MAX690A/692A	4.65/4.40	140	1.6	✓		✓					
MAX691A/693A	4.65/4.40	140/adj.	1.6/adj.	✓	✓/10ns	✓		✓	✓	✓	✓
MAX696	Adj.	35/adj.	1.6/adj.	✓		✓		✓	✓	✓	✓
MAX697	Adj.	35/adj.	1.6/adj.		✓	✓		✓	✓	✓	
MAX700	4.65/adj.	200	-				✓			✓	
MAX703/704	4.65/4.40	140	-	✓		✓	✓				
MAX705/706	4.65/4.40	140	1.6			✓	✓	✓			
MAX706P	2.63	140	1.6			✓	✓	✓		✓	
MAX706R/S/T	2.63/2.93/3.08	140	1.6			✓	✓	✓			
MAX707/708	4.65/4.40	140	-			✓	✓			✓	
MAX708R/S/T	2.63/2.93/3.08	140	-			✓	✓			✓	
MAX709L/M/R/S/T	4.65/4.40/2.63/2.93/3.08	140	-								
MAX791	4.65	140	1	✓	✓/10ns	✓	✓	✓	✓	✓	✓
MAX792L/M/R/S/T	4.65/4.40/2.63/2.93/3.08	140	1		✓/10ns	✓	✓	✓	✓	✓	
MAX800L/M	4.60/4.40	140	1.6/adj.	✓	✓/10ns	✓/±2%		✓	✓	✓	✓
MAX802L/M	4.60/4.40	140	1.6	✓		✓/±2%					
MAX805L	4.65	140	1.6	✓		✓				✓	
MAX813L	4.65	140	1.6			✓	✓	✓		✓	
MAX820L/M/R/S/T	4.65/4.40/2.63/2.93/3.08	140	1		✓/10ns	✓/±2%	✓	✓	✓	✓	
MAX1232	4.37/4.62	250	0.15/0.60/1.2				✓				
MAX1259	-	-	-	✓		✓					

# Power-Supply Monitor with Reset

## Chip Topography



TRANSISTOR COUNT: 380  
SUBSTRATE CONNECTED TO V<sub>CC</sub>

**MAX709**

# Power-Supply Monitor with Reset

## Package Information

(The package drawing(s) in this data sheet may not reflect the most current specifications. For the latest package outline information, go to [www.maxim-ic.com/packages](http://www.maxim-ic.com/packages).)

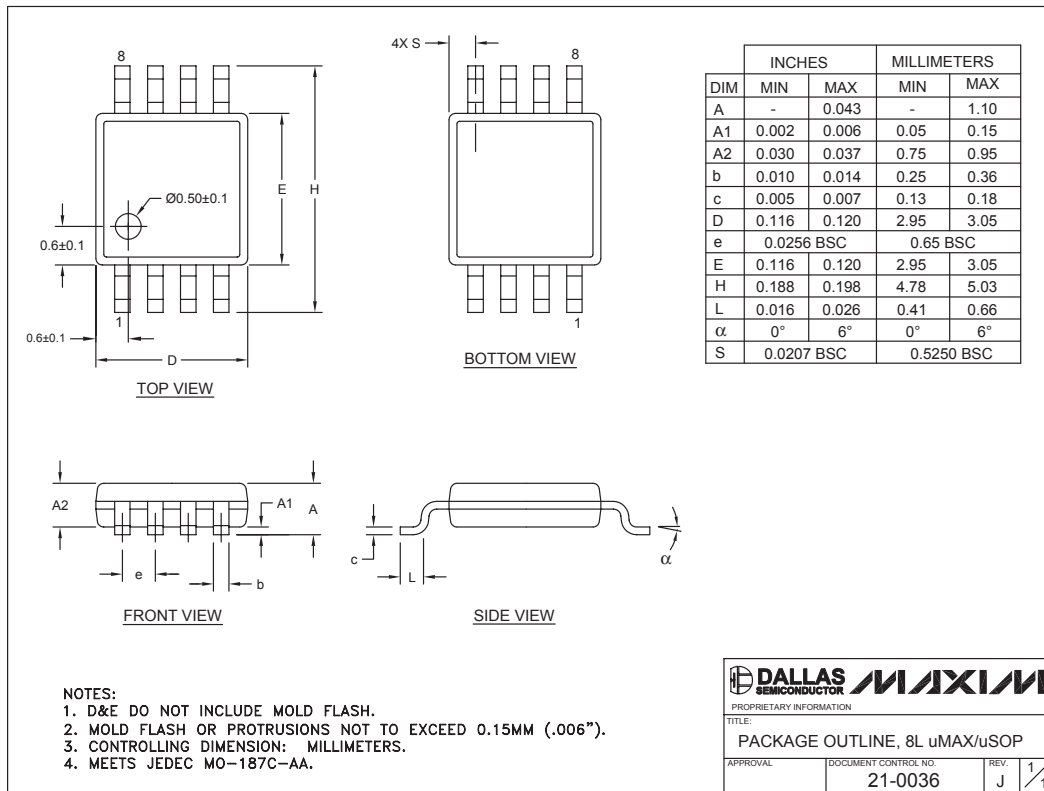

8LUMAXD.EPS

Maxim cannot assume responsibility for use of any circuitry other than circuitry entirely embodied in a Maxim product. No circuit patent licenses are implied. Maxim reserves the right to change the circuitry and specifications without notice at any time.

**8** Maxim Integrated Products, 120 San Gabriel Drive, Sunnyvale, CA 94086 (408) 737-7600

## Looking for pricing, stock, or lifecycle information?

Click below to explore more details on WIN SOURCE:

- ⊖ [View MAX709TCSA+T on WIN SOURCE](#)
- ⊖ [Maxim Integrated Information](#)

## Optimize Your Supply Chain with WIN SOURCE Solutions

- ✓ Global Sourcing Solution
- ✓ Obsolete Management
- ✓ Cost Control Management
- ✓ Shortage Management
- ✓ Alternative Solution
- ✓ Excess Inventory Management