



**THE DATASHEET OF
MAX709LEPA+**





Power-Supply Monitor with Reset

MAX709

General Description

The MAX709 provides a system reset during power-up, power-down, and brownout conditions. When V_{CC} falls below the reset threshold, RESET goes low and holds the μP in reset for 140ms min after V_{CC} rises above the threshold.

The RESET output is guaranteed to be in the correct state with V_{CC} down to 1V. The MAX709 provides excellent circuit reliability and low cost by eliminating external components and adjustments when used with +5V, +3.3V, or +3V powered systems. The MAX709 is available 8-pin DIP, μ MAX, and SO packages.

Features

- ◆ +5V, +3.3V, and +3V Versions
- ◆ No External Components
- ◆ Low Cost
- ◆ Precise Power-Down Reset Threshold
- ◆ 140ms Min Power-On Reset Delay
- ◆ Immune to Short Negative V_{CC} Transients
- ◆ 8-Pin DIP, μ MAX, and SO Packages
- ◆ Low Supply Current: 35 μ A - MAX709R/S/T
65 μ A - MAX709L/M

Ordering Information

PART	TEMP. RANGE	PIN-PACKAGE
MAX709_CPA	0°C to +70°C	8 Plastic DIP
MAX709_CUA	0°C to +70°C	8 μ MAX
MAX709_CSA	0°C to +70°C	8 SO
MAX709_C/D	0°C to +70°C	Dice
MAX709_EPA	-40°C to +85°C	8 Plastic DIP
MAX709_EUA	-40°C to +85°C	8 μ MAX
MAX709_ESA	-40°C to +85°C	8 SO

Devices are available in both leaded and lead-free packaging. Specify lead free by adding the + symbol at the end of the part number when ordering.

*Dice are specified at $T_A = +25^\circ\text{C}$, DC parameters only.

Note: This part offers a choice of five different reset threshold voltages. Select the letter corresponding to the desired nominal reset threshold voltage, and insert it into the blank to complete the part number.

RESET THRESHOLD	
SUFFIX	VOLTAGE (V)
L	4.65
M	4.40
T	3.08
S	2.93
R	2.63

Applications

Minimum Component Count,
Low-Cost Processor Systems

Typical Operating Circuit

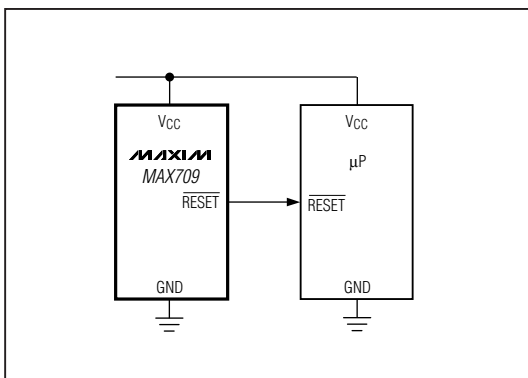

Pin Configuration

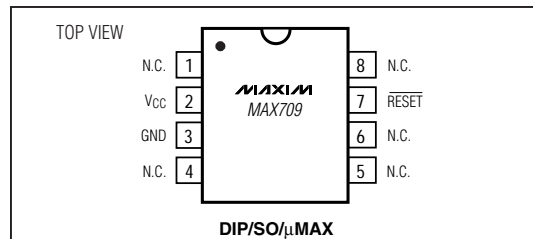

Maxim Integrated Products 1

Call toll free 1-800-998-8800 for free samples or literature.

Power-Supply Monitor with Reset

MAX709

ABSOLUTE MAXIMUM RATINGS

Terminal Voltage (with respect to GND)

V_{CC}-0.3V to 6.0V

RESET.....-0.3V to ($V_{CC} + 0.3V$)

Input Current, V_{CC}20mA

Output Current, RESET.....20mA

Rate-of-Rise, V_{CC}100V/ μ s

Continuous Power Dissipation ($T_A = +70^\circ\text{C}$)

Plastic DIP (derate 9.09mW/ $^\circ\text{C}$ above $+70^\circ\text{C}$).....727mW

μ MAX (derate 4.10mW/ $^\circ\text{C}$ above $+70^\circ\text{C}$).....330mW

SO (derate 5.88mW/ $^\circ\text{C}$ above $+70^\circ\text{C}$).....471mW

Operating Temperature Ranges

MAX709_C..... 0°C to $+70^\circ\text{C}$

MAX709_E..... -40°C to $+85^\circ\text{C}$

Storage Temperature Range..... -65°C to $+160^\circ\text{C}$

Lead Temperature (soldering, 10sec)..... $+300^\circ\text{C}$

Stresses beyond those listed under "Absolute Maximum Ratings" may cause permanent damage to the device. These are stress ratings only, and functional operation of the device at these or any other conditions beyond those indicated in the operational sections of the specifications is not implied. Exposure to absolute maximum rating conditions for extended periods may affect device reliability.

ELECTRICAL CHARACTERISTICS

(V_{CC} = full range, $T_A = T_{MIN}$ to T_{MAX} , unless otherwise noted.)

PARAMETER	CONDITIONS	MIN	TYP	MAX	UNITS
V_{CC} Range	MAX709_C	1.0		5.5	V
	MAX709_E	1.2		5.5	
Supply Current (Note 1)	MAX709R/S/T only	MAX709_C, $V_{CC} < 3.6V$	35	85	μ A
		MAX709_E, $V_{CC} < 3.6V$	35	110	
	All versions	MAX709_C, $V_{CC} < 5.5V$	65	150	
		MAX709_E, $V_{CC} < 5.5V$	65	200	
RESET Threshold, V_{TH}	MAX709L	4.50	4.65	4.75	V
	MAX709M	4.25	4.40	4.50	
	MAX709T	3.00	3.08	3.15	
	MAX709S	2.85	2.93	3.00	
	MAX709R	2.55	2.63	2.70	
V_{CC} to RESET Delay	V_{CC} = reset threshold max to reset threshold min		20		μ s
Reset Active Timeout Period	V_{CC} = reset threshold max, V_{CC} rising	140	280	560	ms
RESET Output Voltage	$I_{SINK} = 1.2mA$, V_{CC} = reset threshold min, MAX709R/S/T only			0.3	V
	$I_{SINK} = 3.2mA$, V_{CC} = reset threshold min, MAX709L/M only			0.4	
	$I_{SINK} = 50\mu A$, $V_{CC} \geq 1.0V$, MAX709_C			0.3	
	$I_{SINK} = 100\mu A$, $V_{CC} \geq 1.2V$, MAX709_E			0.4	
	$I_{SOURCE} = 500\mu A$, $V_{CC} \geq$ reset threshold max, MAX709R/S/T only	$0.8 \times V_{CC}$			
	$I_{SOURCE} = 800\mu A$, $V_{CC} \geq$ reset threshold max, MAX709L/M only	$V_{CC} - 1.5$			

Note 1: Supply current is measured with $V_{CC} = 3.6V$ for MAX709R/S/T, and $V_{CC} = 5.5V$ for all versions.

Power-Supply Monitor with Reset

Typical Operating Characteristics

MAX709

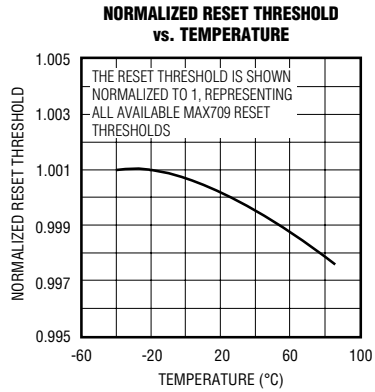
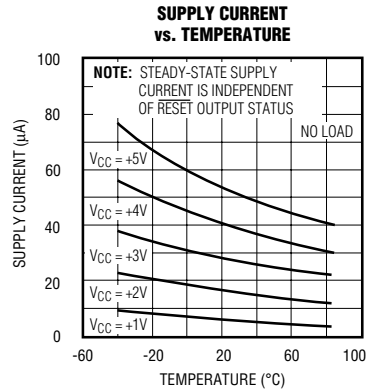
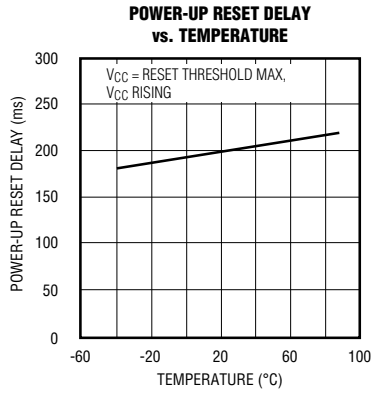

Power-Supply Monitor with Reset

Pin Description

PIN	NAME	FUNCTION
1, 4, 5, 6, 8	N.C.	No Connect. There is no internal connection to this pin.
2	V _{CC}	+5V, +3.3V, or +3V Supply Voltage
3	GND	Ground
7	RESET	Reset Output remains low while V _{CC} is below the reset threshold, and for 280ms after V _{CC} rises above the reset threshold.

Applications Information

Negative-Going V_{CC} Transients

In addition to issuing a reset to the microprocessor (μ P) during power-up, power-down, and brownout conditions, the MAX709 is relatively immune to short duration negative-going V_{CC} transients (glitches).

Figure 1 shows typical transient duration vs. reset comparator overdrive, for which the MAX709 does not generate a reset pulse. The graph was generated using a negative-going pulse applied to V_{CC}, starting 1.5V above the actual reset threshold and ending below it by the magnitude indicated (reset comparator overdrive). The graph indicates the typical maximum pulse width that a negative-going V_{CC} transient may have without causing a reset pulse to be issued. As the magnitude of the transient increases (goes farther below the reset threshold), the maximum allowable pulse width decreases. Typically, for the MAX709L/MAX709M, a V_{CC} transient that goes 100mV below the reset threshold and lasts 40 μ s or less will not cause a reset pulse to be issued.

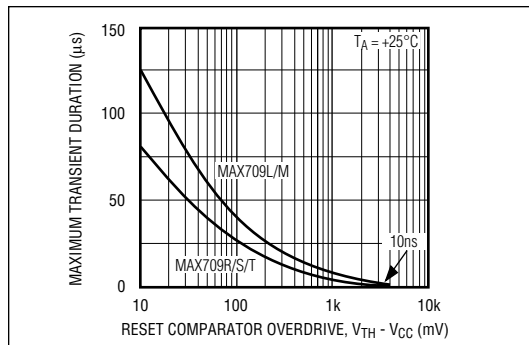

Figure 1. Maximum Transient Duration without Causing a Reset Pulse vs. Reset Comparator Overdrive

A 0.1 μ F bypass capacitor mounted as close as possible to pin 2 (V_{CC}) provides additional transient immunity.

Ensuring a Valid RESET Output Down to V_{CC} = 0V

When V_{CC} falls below 1V, the MAX709 RESET output no longer sinks current—it becomes an open circuit. Therefore, high-impedance CMOS logic inputs connected to the RESET output can drift to undetermined voltages. This presents no problem in most applications, since most μ P and other circuitry is inoperative with V_{CC} below 1V. However, in applications where the RESET output must be valid down to 0V, adding a pull-down resistor to the RESET pin will cause any stray leakage currents to flow to ground, holding RESET low (see Figure 2). The resistance value of R1 is not critical. It should be about 100k Ω , which is large enough not to load RESET and small enough to pull RESET to ground.

Power-Supply Monitor with Reset



Figure 2. RESET Valid to $V_{CC} = \text{Ground}$ Circuit



Figure 3. Interfacing to μPs with Bidirectional Reset I/O

Interfacing to μPs with Bidirectional Reset Pins

Microprocessors with bidirectional reset pins (such as the Motorola 68HC11 series) can contend with the MAX709 RESET output. If, for example the MAX709 RESET output is asserted high and the μP wants to pull it low, indeterminate logic levels may result. To correct this, connect a $4.7\text{k}\Omega$ resistor between the MAX709 RESET output and the μP reset I/O (see Figure 3). Buffer the MAX709 RESET output to other system components.

MAX709

Power-Supply Monitor with Reset

MAX709

μP Supervisory Circuits

Part Number	Nominal Reset Threshold (V)	Minimum Reset Pulse Width (ms)	Nominal Watchdog Timeout Period (sec)	Backup-Battery Switch	CE - Write Protect	Power-Fail Com-parator	Manual-Reset Input	Watch-dog Output	Low-Line Output	Active-High Reset	Battery-On Output
MAX690A/692A	4.65/4.40	140	1.6	✓		✓					
MAX691A/693A	4.65/4.40	140/adj.	1.6/adj.	✓	✓/10ns	✓		✓	✓	✓	✓
MAX696	Adj.	35/adj.	1.6/adj.	✓		✓		✓	✓	✓	✓
MAX697	Adj.	35/adj.	1.6/adj.		✓	✓		✓	✓	✓	
MAX700	4.65/adj.	200	-				✓			✓	
MAX703/704	4.65/4.40	140	-	✓		✓	✓				
MAX705/706	4.65/4.40	140	1.6			✓		✓			
MAX706P	2.63	140	1.6			✓	✓	✓		✓	
MAX706R/S/T	2.63/2.93/3.08	140	1.6			✓	✓	✓			
MAX707/708	4.65/4.40	140	-			✓	✓			✓	
MAX708R/S/T	2.63/2.93/3.08	140	-			✓	✓			✓	
MAX709L/M/R/S/T	4.65/4.40/2.63/2.93/3.08	140	-								
MAX791	4.65	140	1	✓	✓/10ns	✓	✓	✓	✓	✓	✓
MAX792L/M/R/S/T	4.65/4.40/2.63/2.93/3.08	140	1		✓/10ns	✓	✓	✓	✓	✓	
MAX800L/M	4.60/4.40	140	1.6/adj.	✓	✓/10ns	✓/±2%		✓	✓	✓	✓
MAX802L/M	4.60/4.40	140	1.6	✓		✓/±2%					
MAX805L	4.65	140	1.6	✓		✓				✓	
MAX813L	4.65	140	1.6			✓	✓	✓		✓	
MAX820L/M/R/S/T	4.65/4.40/2.63/2.93/3.08	140	1		✓/10ns	✓/±2%	✓	✓	✓	✓	
MAX1232	4.37/4.62	250	0.15/0.60/1.2				✓				
MAX1259	-	-	-	✓		✓					

Power-Supply Monitor with Reset

Chip Topography



TRANSISTOR COUNT: 380
SUBSTRATE CONNECTED TO V_{CC}

MAX709

Power-Supply Monitor with Reset

MAX709

Package Information

(The package drawing(s) in this data sheet may not reflect the most current specifications. For the latest package outline information, go to www.maxim-ic.com/packages.)

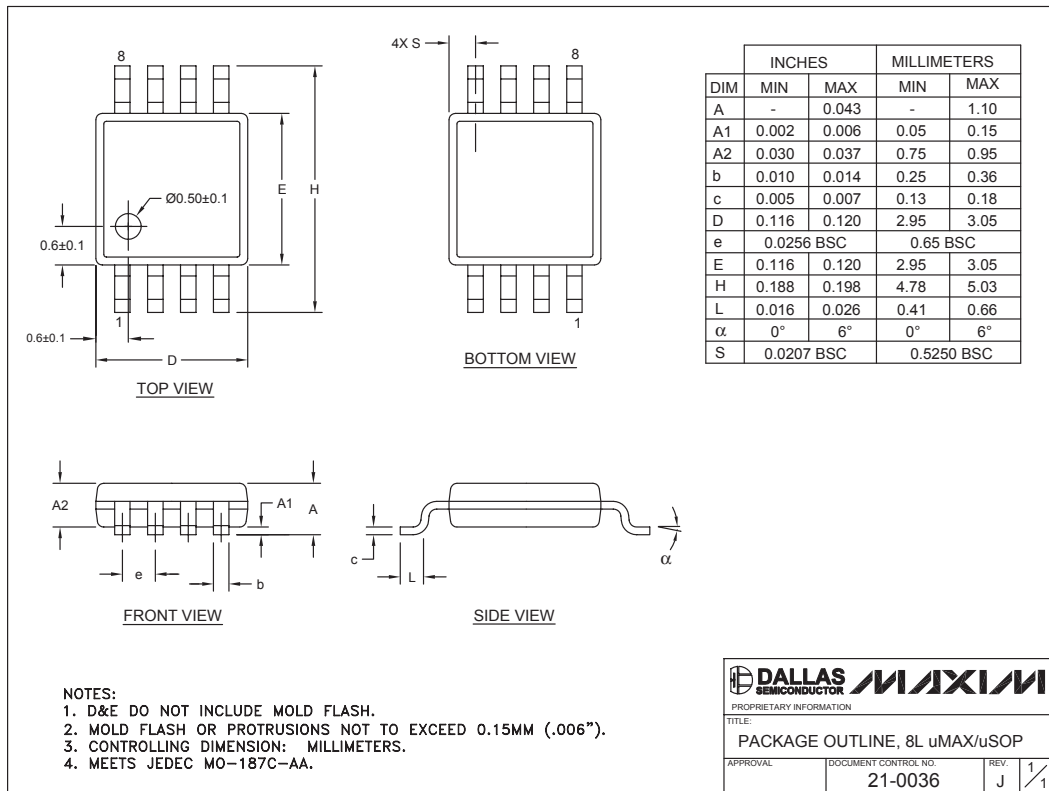

8LUMAXD.EPS

Maxim cannot assume responsibility for use of any circuitry other than circuitry entirely embodied in a Maxim product. No circuit patent licenses are implied. Maxim reserves the right to change the circuitry and specifications without notice at any time.

8 Maxim Integrated Products, 120 San Gabriel Drive, Sunnyvale, CA 94086 (408) 737-7600

© 2005 Maxim Integrated Products

Printed USA

MAXIM is a registered trademark of Maxim Integrated Products, Inc.

Looking for pricing, stock, or lifecycle information?

Click below to explore more details on WIN SOURCE:

 [View MAX709LEPA+](#) on WIN SOURCE

 [Maxim Integrated](#) Information

Optimize Your Supply Chain with WIN SOURCE Solutions

-  Global Sourcing Solution
-  Obsolete Management
-  Cost Control Management
-  Shortage Management
-  Alternative Solution
-  Excess Inventory Management