



**THE DATASHEET OF  
MAX6653AEE+T**





# Temperature Monitors and PWM Fan Controllers

MAX6653/MAX6663/MAX6664

## General Description

The MAX6653/MAX6663/MAX6664 are ACPI-compliant local and remote-junction temperature sensors and fan controllers. These devices measure their own die temperature, as well as the temperature of a remote-PN junction and control the speed of a DC cooling fan based on the measured temperature. Remote temperature measurement accuracy is  $\pm 1^\circ\text{C}$  from  $+60^\circ\text{C}$  to  $+100^\circ\text{C}$ . Temperature measurement resolution is  $0.125^\circ\text{C}$  for both local and remote temperatures.

Internal watchdog set points are provided for both local and remote temperatures. There are two comparison set points for local temperatures and two for remote temperatures. When a set point is crossed, the MAX6653/MAX6663/MAX6664 assert either the  $\overline{\text{INT}}$  or  $\overline{\text{THERM}}$  outputs. These outputs can be used as interrupts, clock throttle signals, or overtemperature shutdown signals. Two pins on the MAX6653 control the power-up values of the comparison set points, providing fail-safe protection even when the system is unable to program the trip temperatures. The MAX6653 has two additional shutdown outputs,  $\overline{\text{SDR}}$  and  $\overline{\text{SDL}}$ , that are triggered when the remote or local temperatures exceed the programmed shutdown set points. The  $\overline{\text{INT}}$  output for the MAX6653/MAX6663 and  $\overline{\text{THERM}}$  outputs for the MAX6653/MAX6663/MAX6664 can also function as inputs if either is pulled low to force the fan to full speed, unless this function is masked by the user.

The MAX6653/MAX6663/MAX6664 are available in 16-pin QSOP packages and operate over the  $-40^\circ\text{C}$  to  $+125^\circ\text{C}$  temperature range.

## Applications

Personal Computers  
Servers  
Workstations  
Telecom Equipment  
Networking Equipment  
Test Equipment  
Industrial Controls

*Typical Operating Circuits appear at end of data sheet.  
Functional Diagram appears at end of data sheet.*

## Features

- ◆ Remote-Junction Temperature Sensor Within  $\pm 1^\circ\text{C}$  Accuracy ( $+60^\circ\text{C}$  to  $+100^\circ\text{C}$ )
- ◆ ACPI-Compatible Programmable Temperature Alarms
- ◆  $0.125^\circ\text{C}$  Resolution Local and Remote-Junction Temperature Measurement
- ◆ Programmable Temperature Offset for System Calibration
- ◆ SMBus 2-Wire Serial Interface with Timeout
- ◆ Automatic or Manual Fan-Speed Control
- ◆ PWM Fan Control Output
- ◆ Fan-Speed Monitoring and Watchdog
- ◆ Fan Fault and Failure Indicators
- ◆ Compatible with 2-Wire or 3-Wire Fans (Tachometer Output)
- ◆ +3V to +5.5V Supply Range
- ◆ Additional Shutdown Set Point (MAX6653)
- ◆ Controlled PWM Rise/Fall Times

## Ordering Information

PART	TEMP RANGE	PIN-PACKAGE
MAX6653AEE	$-40^\circ\text{C}$ to $+125^\circ\text{C}$	16 QSOP
MAX6663AEE	$-40^\circ\text{C}$ to $+125^\circ\text{C}$	16 QSOP
MAX6664AEE	$-40^\circ\text{C}$ to $+125^\circ\text{C}$	16 QSOP

## Pin Configurations

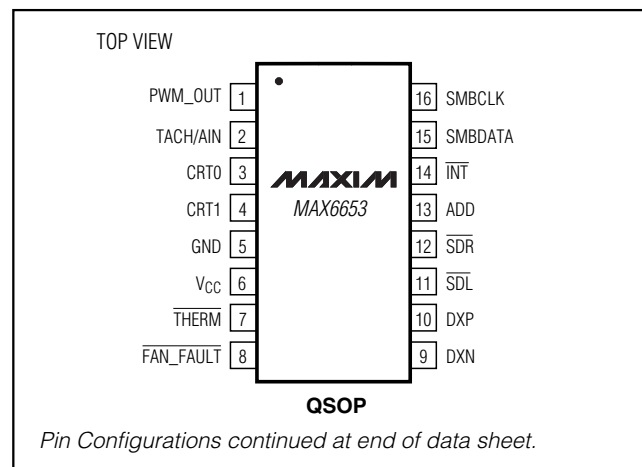

# Temperature Monitors and PWM Fan Controllers

## ABSOLUTE MAXIMUM RATINGS

All Voltages Are Referenced to GND

TACH/AIN	-0.3V to +5.5V
V <sub>CC</sub>	-0.3V to +6V
DXP, ADD, CRIT0, CRIT1	-0.3V to + (V <sub>CC</sub> + 0.3V)
DXN	-0.3V to +0.8V
SMBDATA, SMBCLK, INT, THERM, FAN_FAULT, SDL, SDR	-0.3V to +6V
SMBDATA, INT, THERM, FAN_FAULT, PWM_OUT Current	-1mA to +50mA

DXN Current	±1mA
ESD Protection (all pins, Human Body Model)	2000V
Continuous Power Dissipation (T <sub>A</sub> = +70°C)	16-Pin QSOP (derate 8.3 mW/°C above +70°C).....667mW
Operating Temperature Range	-40°C to +125°C
Junction Temperature	+150°C
Storage Temperature Range	-65°C to +165°C
Lead Temperature (soldering, 10s)	+300°C

Stresses beyond those listed under "Absolute Maximum Ratings" may cause permanent damage to the device. These are stress ratings only, and functional operation of the device at these or any other conditions beyond those indicated in the operational sections of the specifications is not implied. Exposure to absolute maximum rating conditions for extended periods may affect device reliability.

## ELECTRICAL CHARACTERISTICS

(V<sub>CC</sub> = +3.0V to +5.5V, T<sub>A</sub> = 0°C to +125°C, unless otherwise noted. Typical values are at V<sub>CC</sub> = +3.3V, T<sub>A</sub> = +25°C.) (Note 1)

PARAMETER	SYMBOL	CONDITIONS	MIN	TYP	MAX	UNITS
Operating Supply Voltage Range	V <sub>CC</sub>		3.0		5.5	V
Standby Current		SMBDAT = SMBCLK = 1, register 00h = 00h			10	µA
Operating Current	I <sub>S</sub>	SMBDAT = SMBCLK = 1		0.5	1	mA
Average Operating Current		Conversion rate = 4Hz (default)		150	300	µA
External Temperature Error		V <sub>CC</sub> = +3.3V, T <sub>A</sub> = 0°C to +100°C, +60°C ≤ T <sub>R</sub> ≤ +100°C			±1	°C
		V <sub>CC</sub> = +3.3V, 0°C ≤ T <sub>R</sub> ≤ +100°C			±3	
		V <sub>CC</sub> = +3.3V, -25°C ≤ T <sub>R</sub> ≤ +125°C			±4	
Internal Temperature Error		V <sub>CC</sub> = +3.3V, 0°C ≤ T <sub>A</sub> ≤ +100°C			±2	°C
		V <sub>CC</sub> = +3.3V, -40°C ≤ T <sub>A</sub> ≤ +125°C			±4	
Temperature Resolution (Internal and External)			0.125			°C
			11			Bits
Fan TACHOMETER Accuracy		(Note 2)			6	%
Fan TACHOMETER Full-Scale Count				255		
TACHOMETER Nominal Input RPM		Divisor = 1, fan count = 153		4400		RPM
		Divisor = 2, fan count = 153		2200		
		Divisor = 4, fan count = 153		1100		
		Divisor = 8, fan count = 153		550		
Internal Clock Frequency			254	270	286	kHz
TACHOMETER Conversion Cycle Time				637		ms

# Temperature Monitors and PWM Fan Controllers

MAX6653/MAX6663/MAX6664

## ELECTRICAL CHARACTERISTICS (continued)

(V<sub>CC</sub> = +3.0V to +5.5V, T<sub>A</sub> = 0°C to +125°C, unless otherwise noted. Typical values are at V<sub>CC</sub> = +3.3V, T<sub>A</sub> = +25°C.) (Note1)

PARAMETER	SYMBOL	CONDITIONS	MIN	TYP	MAX	UNITS
Temperature Conversion Time				250		ms
Conversion Rate Timing Error		(Note 2)	25		25	%
Remote-Diode Sourcing Current		High level	80	100	120	μA
		Low level	8	10	12	
DXN Source Voltage				0.7		V
TACHOMETER Input Hysteresis				100		mV
Output Low Voltage (Sink Current)	V <sub>OL</sub>	SDL, SDR, THERM, FAN_FAULT, SMBDATA, PWM_OUT, V <sub>CC</sub> = +3V, I <sub>OUT</sub> = 6mA, INT, V <sub>CC</sub> = +3V, I <sub>OUT</sub> = 4mA			0.4	V
Output High Leakage Current	I <sub>OH</sub>	INT, SDL, SDR, THERM, FAN_FAULT, SMBDATA, PWM_OUT			1	μA
Logic Low Input Voltage	V <sub>IL</sub>	SMBDATA, SMBCLK, INT, THERM, TACH/AIN			0.8	V
Logic High Input Voltage	V <sub>IH</sub>	SMBDATA, SMBCLK, INT, THERM, TACH/AIN	3.0V	2.2		V
			5.5V	2.6		
Input Leakage Current	I <sub>LEAK</sub>	SMBDATA, SMBCLK, INT, THERM; V <sub>IN</sub> = V <sub>CC</sub> or GND			±1	μA
Input Capacitance	C <sub>IN</sub>			5		pF
<b>SMBus TIMING</b>						
Serial Clock Frequency	f <sub>SCLK</sub>	(Note 2)	10		100	kHz
Clock Low Period	t <sub>LOW</sub>	10% to 10% (Note 2)	4			μs
Clock High Period	t <sub>HIGH</sub>	90% to 90% (Note 2)	4.7			μs
Bus Free Time Between Stop and Start Condition	t <sub>BUF</sub>	(Note 2)	4.7			μs
SMBus Start Condition Setup Time	t <sub>SU:STA</sub>	90% of SMBCLK to 90% of SMBDATA (Note 2)	4.7			μs
Start Condition Hold Time	t <sub>HD:STO</sub>	10% of SMBDATA to 10% of SMBCLK (Note 2)	4			μs
Stop Condition Setup Time	t <sub>SU:STO</sub>	90% of SMBCLK to 10% of SMBDATA (Note 2)	4			μs
Data Setup Time	t <sub>SU:DAT</sub>	10% of SMBDATA to 10% of SMBCLK (Note 2)	250			ns
Data Hold Time	t <sub>HD:DAT</sub>	10% of SMBCLK to 10% of SMBDATA (Note 2)	300			ns
SMBus Fall Time	t <sub>F</sub>	(Note 2)			300	ns
SMBus Rise Time	t <sub>R</sub>	(Note 2)			1000	ns
SMBus Timeout			29	37	45	ms

**Note 1:** Tested at +85°C. Values through the temperature range are guaranteed by design.

**Note 2:** Not production tested, guaranteed by design.

# Temperature Monitors and PWM Fan Controllers

## Typical Operating Characteristics

( $T_A = +25^\circ\text{C}$ , unless otherwise noted.)

**STANDBY SUPPLY CURRENT vs. SUPPLY VOLTAGE**

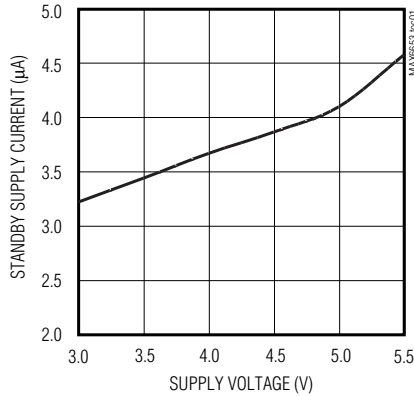

**AVERAGE OPERATING SUPPLY CURRENT vs. CONVERSION RATE**

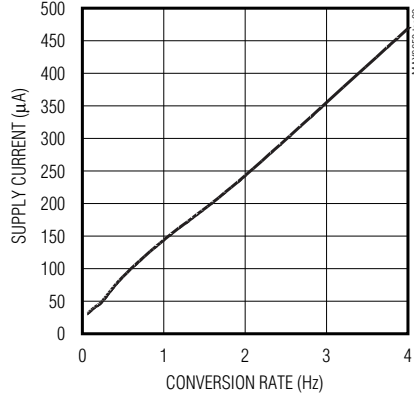

**REMOTE TEMPERATURE ERROR vs. REMOTE-DIODE TEMPERATURE**

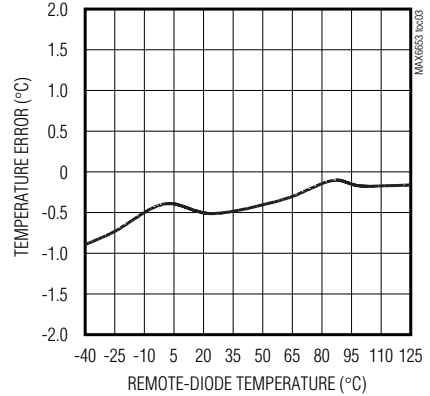

**LOCAL TEMPERATURE ERROR vs. DIE TEMPERATURE**

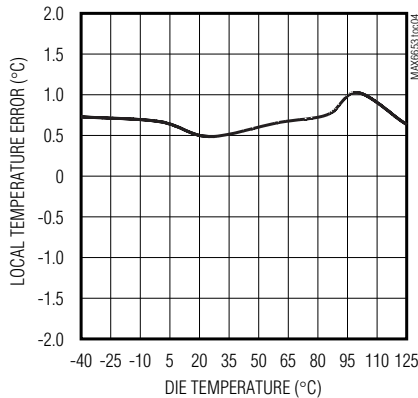

**REMOTE TEMPERATURE ERROR vs. POWER-SUPPLY NOISE FREQUENCY**

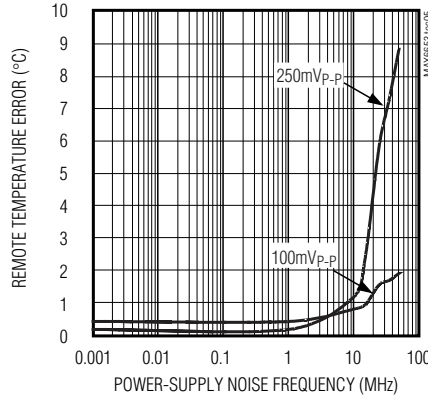

**LOCAL TEMPERATURE ERROR vs. POWER-SUPPLY NOISE FREQUENCY**

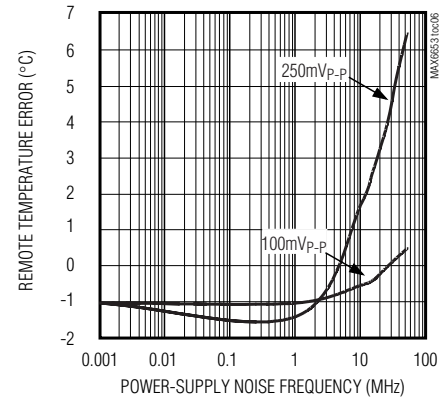

**TEMPERATURE ERROR vs. COMMON-MODE NOISE FREQUENCY**

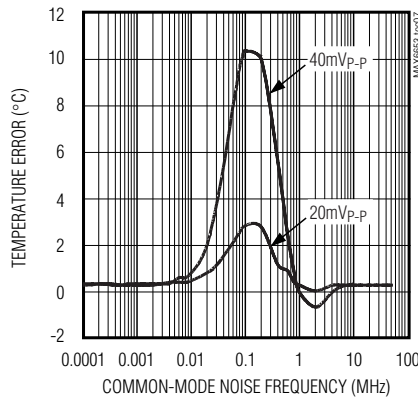

**TEMPERATURE ERROR vs. DIFFERENTIAL-MODE NOISE FREQUENCY**

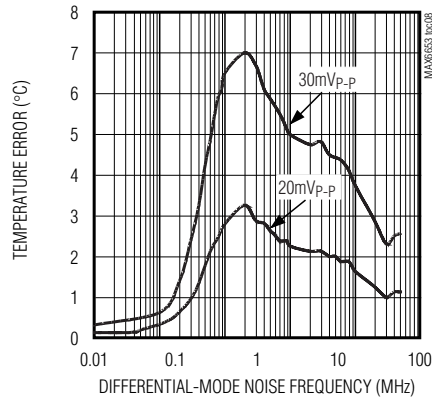

**TEMPERATURE ERROR vs. DXP-DXN CAPACITANCE**

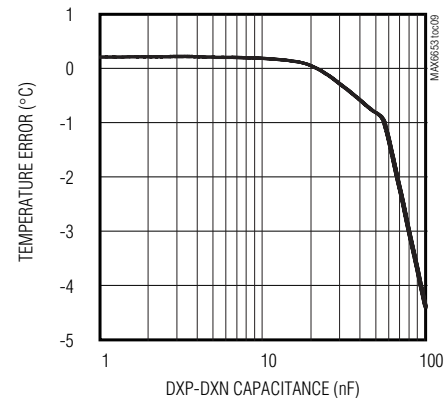

# Temperature Monitors and PWM Fan Controllers

## Pin Description

MAX6653/MAX6663/MAX6664

PIN		NAME	FUNCTION
MAX6653 QSOP	MAX6663/ MAX6664 QSOP		
1	1	PWM_OUT	Digital Output (Open Drain). Pulse-width modulated output to external power transistor. Requires a pullup resistor (10kΩ typ).
2	2	TACH/AIN	Digital/Analog Input. Fan tachometer input. May be reprogrammed as an analog input to measure speed of a 2-wire fan. See Figure 5.
3	—	CRIT0	Input. Used in conjunction with CRIT1 to set $\overline{\text{THERM}}$ and $\overline{\text{SHUTDOWN}}$ default set points (see Table 1).
4	—	CRIT1	Input. Used in conjunction with CRIT0 to set $\overline{\text{THERM}}$ and $\overline{\text{SHUTDOWN}}$ default set points (see Table 1).
—	3, 4	N.C.	No Connection. Not internally connected.
5	5	GND	Ground
6	6	VCC	Power Supply. Bypass with a 0.01μF capacitor to GND.
7	7	$\overline{\text{THERM}}$	Digital I/O (Open Drain). An active-low thermal-overload output to indicate that the overtemperature set point has been exceeded. Also acts as an input to provide external fan control. When this pin is pulled low by an external signal, a status bit is set and the fan speed is forced full-on. Requires a pullup resistor (10kΩ typ).
8	8	$\overline{\text{FAN\_FAULT}}$	Digital Output (Active Low, Open Drain). Signals a fan fault. Requires a pullup resistor (10kΩ typ).
9	9	DXN	Combined Current Sink and A/D Negative Input. DXN is internally biased to a diode voltage above ground.
10	10	DXP	Combined Current Source and A/D Positive Input for the Remote-Diode Channel. Do not leave DXP floating; connect DXP to DXN if no remote diode is used. Place a 2200pF capacitor between DXP and DXN for noise filtering.
11	—	$\overline{\text{SDL}}$	An Active-Low Open-Drain Output. It indicates that local temperature is above the shutdown set point. Normally used to directly deactivate the CPU power supply.
12	—	$\overline{\text{SDR}}$	An Active-Low Open-Drain Output. It indicates that remote temperature is above the shutdown set point. Normally used to directly deactivate the CPU power supply.
—	11, 12	N.C.	Internal Connection. Leave floating or connect to GND.
13	13	ADD	Three-State Logic Input. Sets the 2 lower bits of the device SMBus address (Table 2). ADD is not an ordinary logic input pin; ADD should be connected to VCC, GND, or float.
14	14	$\overline{\text{INT}}$	Digital Output (Open Drain). Can be programmed as an interrupt output for temperature/fan speed interrupts. Requires a pullup resistor (10kΩ typ). For the MAX6653/MAX6663, it can be used also as an input. If pulled low, fan speed is forced to maximum unless masked.
15	15	SMBDATA	SMBus Serial-Data Input/Output (Open Drain). Requires a pullup resistor (10kΩ typ).
16	16	SMBCLK	SMBus Serial-Clock Input. Requires a pullup resistor (10kΩ typ).
—	12	N.C.	Internal Connection. Leave floating or connect to GND.

# Temperature Monitors and PWM Fan Controllers

**Table 1. MAX6653 Power-Up Set-Point Decoding**

CRIT1	CRIT0	THERM SET POINT (°C)		SHUTDOWN SET POINT (°C)	
		REMOTE	LOCAL	REMOTE	LOCAL
GND	Open	85	55	110	80
GND	GND	90	60	115	85
GND	V <sub>CC</sub>	95	65	120	90
Open	Open	100	70	125	95
Open	GND	105	75	125	95
Open	V <sub>CC</sub>	110	80	125	95
V <sub>CC</sub>	Open	115	85	125	95
V <sub>CC</sub>	GND	120	90	125	95
V <sub>CC</sub>	V <sub>CC</sub>	125	95	125	95

## Detailed Description

The MAX6653/MAX6663/MAX6664 are local/remote temperature monitors and fan controllers for micro-processor-based systems. These devices communicate with the system through a serial SMBus interface. The serial bus controller features a hard-wired address pin for device selection, an input line for a serial clock, and a serial line for reading and writing addresses and data (see *Functional Diagram*).

The MAX6653/MAX6663/MAX6664 fan control section can operate in three modes. In the automatic fan-control mode, the fan's power-supply voltage is automatically adjusted based on temperature. The control algorithm parameters are programmable to allow optimization to the characteristics of the fan and the system. RPM select mode forces the fan speed to a programmed tachometer value. PWM duty cycle select mode allows user selection of the PWM duty cycle. PWM rise and fall times are limited to maximize fan reliability.

To ensure overall system reliability, the MAX6653/MAX6663/MAX6664 feature an SMBus timeout so that the MAX6653/MAX6663/MAX6664 can never "lock" the SMBus. Furthermore, the availability of hard-wired default values for critical temperature set points ensures the MAX6653 controls critical temperature events properly even if the SMBus is "locked" by some other device on the bus.

### SMBus Digital Interface

From a software perspective, the MAX6653/MAX6663/MAX6664 appear as a set of byte-wide registers. These devices use a standard SMBus 2-wire/I<sup>2</sup>C-compatible serial interface to access the internal registers. The MAX6653/MAX6663/MAX6664 slave address can be set to three different values by the input pin ADD

(Table 2) and, therefore, a maximum of three MAX6653/MAX6663/MAX6664 devices can share the same bus.

The MAX6653/MAX6663/MAX6664 employ four standard SMBus protocols: Write Byte, Read Byte, Send Byte, and Receive Byte (Figures 1, 2, and 3). The shorter Receive Byte protocol allows quicker transfers, provided that the correct data register was previously selected by a Read Byte instruction. Use caution with the shorter protocols in multimaster systems, since a second master could overwrite the command byte without informing the first master.

### Alert Response Address

The MAX6653/MAX6663/MAX6664 respond to the SMBus alert response address, an event which typically occurs after an SMBus host master detects an  $\overline{\text{INT}}$  interrupt signal going active (referred to as  $\overline{\text{ALERT}}$  in SMBus nomenclature). When the host master puts the alert response address (0001 1001) on the bus, all devices with an active  $\overline{\text{INT}}$  output respond by putting their own address onto the bus. The alert response can activate several different slave devices simultaneously, similar to the I<sup>2</sup>C general call. If more than one slave attempts to respond, bus arbitration rules apply, and the device with the lowest address code wins. The master then services the devices from the lowest address up.

**Table 2. MAX6653/MAX6663/MAX6664 Slave Address Decoding**

ADD PIN	ADDRESS
GND	0101 100
No connect	0101 110
V <sub>CC</sub>	0101 101

# Temperature Monitors and PWM Fan Controllers

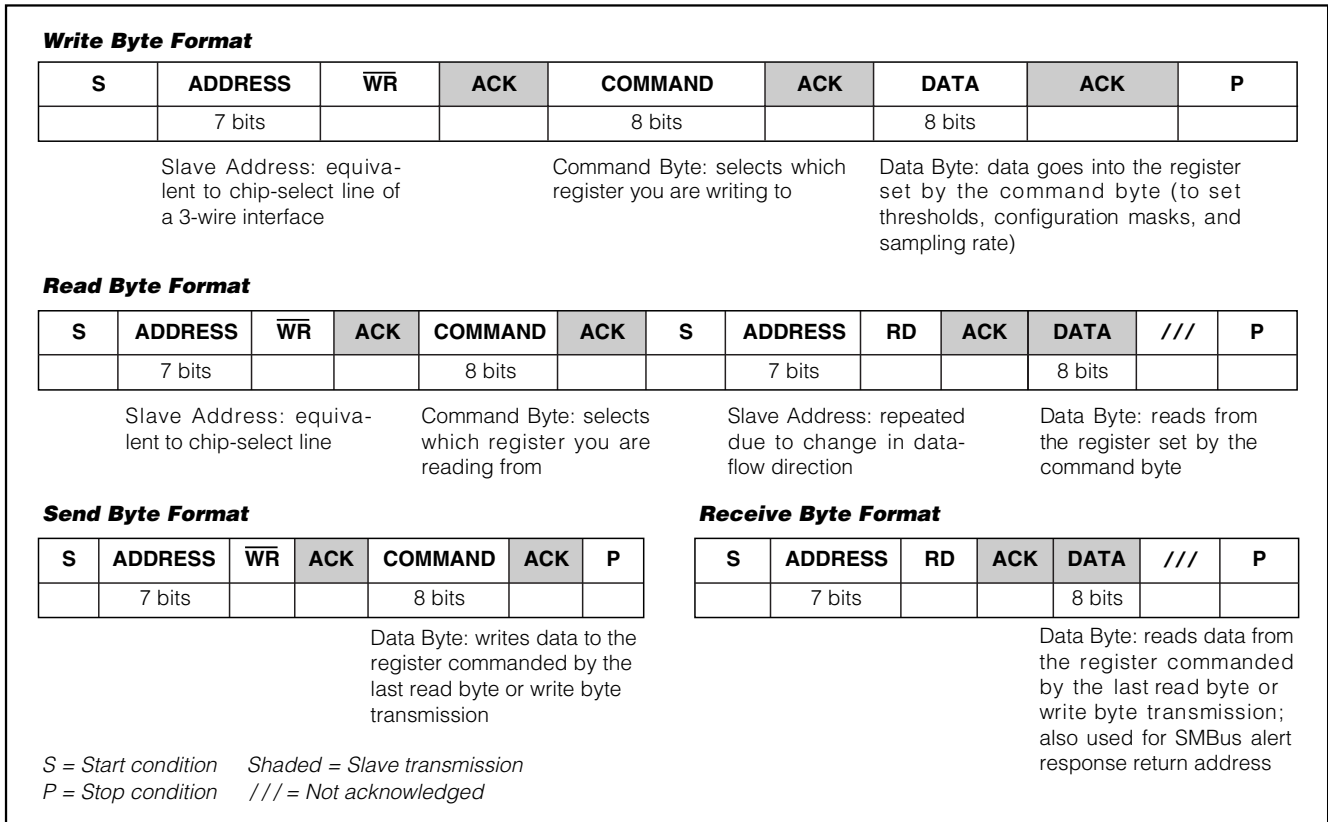

Figure 1. SMBus Protocols

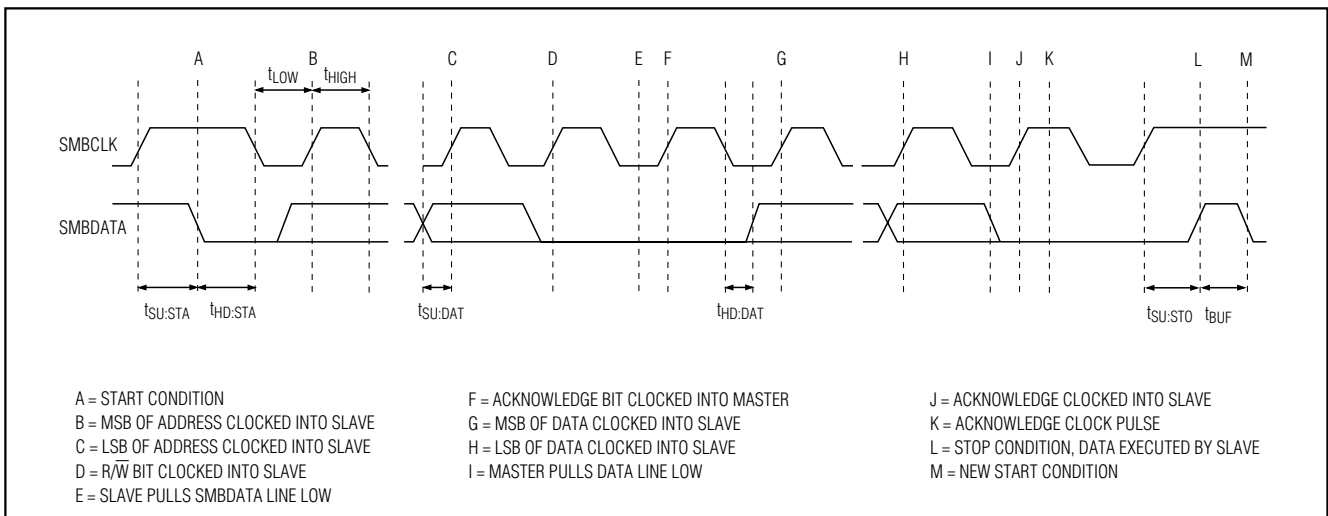

Figure 2. SMBus Write Timing Diagram

# Temperature Monitors and PWM Fan Controllers

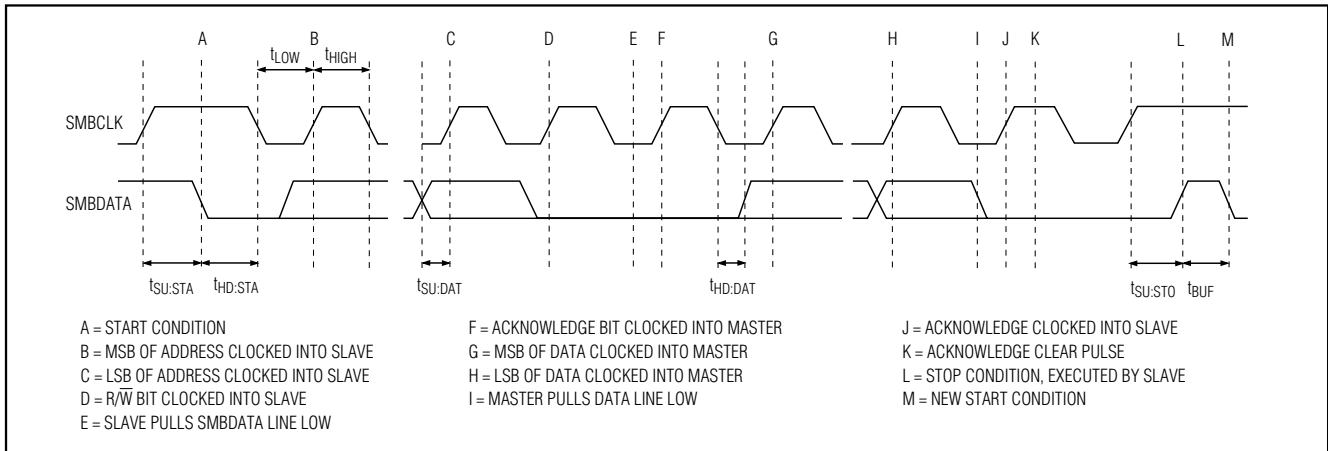

Figure 3. SMBus Read Timing Diagram

The MAX6663 resets its  $\overline{\text{INT}}$  output and some of the status bits in the status register after responding to an alert response address; however, if the error condition that caused the interrupt is still present,  $\overline{\text{INT}}$  is reasserted on the next monitoring cycle.  $\overline{\text{INT}}$  is maskable to allow full control of ALERT conditions.

### Temperature Measurement

The MAX6653/MAX6663/MAX6664 contain on-chip temperature sensors to sense their own die (local) temperatures. These devices can also measure remote temperatures such as the die temperature of CPUs or other ICs having on-chip temperature-sensing diodes, or discrete diode-connected transistors as shown in the *Typical Operating Circuits*. For best accuracy, the discrete diode-connected transistor should be a small-signal device with its collector and base connected together. The on-chip ADC converts the sensed temperature and outputs the temperature data in the format shown in Tables 3 and 4. The temperature measurement resolution is 0.125°C for both local and remote temperatures. The temperature accuracy is within ±1°C for remote temperature measurements from +60°C to +100°C.

The Local Temperature Offset (0Dh) and Remote Temperature Offset (0Eh) registers allow the measured temperature to be increased or decreased by a fixed value to compensate for errors due to variations in diode resistance and ideality factor (see the *Remote Diode Considerations* section). The reported temperature is the measured temperature plus the correction value. Both the measured temperature and the reported value are limited by the sensor's temperature range. For example, if a remote thermal diode is being measured and its temperature is 135°C, the measured temperature is the maximum

value of 127.875°C. If the remote offset value is set to -10°C, the reported value is 117.875°C, not 125°C.

The temperature conversion rate is programmable using bits [4:2] of the fan filter register (23h) as shown in Table 5.

The DXN input is biased at 0.65V above ground by an internal diode to set up the analog-to-digital inputs for a differential measurement. The worst-case DXP-DXN differential input voltage range is from 0.25V to 0.95V. Excess resistance in series with the remote diode causes about 0.5°C error per ohm. Likewise, a 200µV offset voltage forced on DXP-DXN causes about 1°C error.

High-frequency EMI is best filtered at DXP and DXN with an external 2200pF capacitor. This value can be increased to about 3300pF, including cable capacitance. Capacitance higher than 3300pF introduces errors due to the rise time of the switched current source.

Table 3. Temperature Data High Byte Format

TEMP (°C)	DIGITAL OUTPUT (°C)	DIGITAL OUTPUT (BINARY)
130.00	+127	0111 1111
127.00	+127	0111 1111
126.00	+126	0111 1110
25.25	+25	0001 1001
0.50	0	0000 0000
0.00	0	0000 0000
-1	—	1111 1111
-125	—	1000 0011
-128	—	1000 0000
Diode fault (short or open)	—	1000 0000

# Temperature Monitors and PWM Fan Controllers

MAX6653/MAX6663/MAX6664

**Table 4. Temperature Data Low Byte Format Structure: LLLXRRR\***

FRACTIONAL TEMPERATURE (°C)	DIGITAL OUTPUT (LOCAL)	DIGITAL OUTPUT (REMOTE)
0.000	000X XXXX	XXX XX 000
0.125	001X XXXX	XXX XX 001
0.25	010X XXXX	XXX XX 010
0.375	011X XXXX	XXX XX 011
0.5	100X XXXX	XXX XX 100
0.625	101X XXXX	XXX XX 101
0.75	110X XXXX	XXX XX 110
0.875	111X XXXX	XXX XX 111

\*Where: LLL = local fractional temperature bits, XX = don't care, RRR = remote fractional temperature bits.

**Table 5. Temperature Conversion Rate Setting (Fan Filter Register (23h)—POR = 111)**

BIT 4	BIT 3	BIT2	CONVERSION RATE (Hz)	CONVERSION TIME (s)
0	0	0	0.0625	16
0	0	1	0.125	8
0	1	0	0.25	4
0	1	1	0.5	2
<b>1</b>	<b>0</b>	<b>0</b>	<b>1</b>	<b>1</b>
1	0	1	2	0.5
1	1	0	4	0.25
1	1	1	4	0.25

**Table 6. Threshold Limit Registers**

NAME	ADDRESS	R/W	MAX6653 POR VALUE	MAX6663/MAX6664 POR STATE	DESCRIPTION
LTH	14h	R/W	Set by CRIT0 and CRIT1	0011 1100	Local temp high limit
LTL	15h	R/W	Set by CRIT0 and CRIT1	0000 0000	Local temp low limit
L THER	16h	R/W	Set by CRIT0 and CRIT1	0100 0110	Local temp THERM limit
RTH	18h	R/W	Set by CRIT0 and CRIT1	0101 0000	Remote temp high limit
RTL	19h	R/W	Set by CRIT0 and CRIT1	0000 0000	Remote temp low limit
R THER	1Ah	R/W	Set by CRIT0 and CRIT1	0110 0100	Remote temp THERM limit
LTSD	1Bh	R/W	Set by CRIT0 and CRIT1	N/A	Local temp shutdown limit (MAX6653 only)
RTSD	1Ch	R/W	Set by CRIT0 and CRIT1	N/A	Remote temp shutdown limit (MAX6653 only)

## Temperature Comparison and Interrupt System

At the end of each conversion cycle, the converted temperature data are compared to various set-point thresholds to control the INT, THERM, SDL, and SDR outputs. All temperature threshold limits are stored in the threshold limit registers (Table 6) and can be changed through the SMBus digital interface.

$\overline{\text{THERM}}$  is an active-low thermal-overload output indicating that the THERM overtemperature set point is exceeded. With the  $\overline{\text{THERM}}$  threshold set to an appropriate value, the  $\overline{\text{THERM}}$  output can be used to control clock throttling. When this pin is pulled low by an external signal, a status bit (bit 7, status register 2) is set, and the fan speed is unconditionally forced to full-on speed. The only way to reset the status bit is to read status register 2. Connect a 10k $\Omega$  pullup resistor between  $\overline{\text{THERM}}$  and VCC.

# Temperature Monitors and PWM Fan Controllers

$\overline{\text{INT}}$  is an open-drain digital output that reports the status of temperature interrupt limits and fan out-of-limit conditions. Set bit 1 of configuration register 1 (00h) to 1 to enable  $\overline{\text{INT}}$  output or reset this bit to zero to disable the  $\overline{\text{INT}}$  output function. Status register 1 contains status information for the conditions that cause  $\overline{\text{INT}}$  to assert. Reading status register 1 resets  $\overline{\text{INT}}$ , but  $\overline{\text{INT}}$  is reasserted if the fault condition still exists. Connect a 10k $\Omega$  pullup resistor between  $\overline{\text{INT}}$  and VCC.

$\overline{\text{SDL}}$  and  $\overline{\text{SDR}}$  are open-drain digital outputs on the MAX6653 that can be used to shut the system down based on the local (die) temperature of the MAX6653 or the temperature of the remote sensor, respectively. The trip thresholds for  $\overline{\text{SDL}}$  and  $\overline{\text{SDR}}$  are normally set above the  $\overline{\text{THERM}}$  and  $\overline{\text{INT}}$  limits. Their power-up values are set by the CRIT1 and CRIT0 pins, as shown in Table 1.

## Fan-Speed Control

The MAX6653/MAX6663/MAX6664 fan-control section can operate in one of three modes depending on the setting of bit 7 to bit 5 of configuration register 1 (00h). Regardless of the mode of operation, the PWM output frequency is programmable, and the fan speed is measured with the result stored in the fan-speed register (08h).

### PWM Output Frequency

The PWM output frequency is programmed by bit 5, bit 4, and bit 3 of the fan characteristics register (20h), regardless of the mode of operation. See Table 7.

### Fan-Control Mode

The mode of fan-speed control operation is set by bit 7, bit 6, and bit 5 in configuration register 1 (00h), as shown in Table 8.

### PWM Duty-Cycle Fan-Control Mode

Bits [3:0] of the fan-speed configuration register set the PWM duty cycle. See Table 9 for more details.

### RPM Select Fan-Control Mode

In RPM select mode, the MAX6653/MAX6663/MAX6664 adjust their PWM output duty cycle to match a selected fan speed measured by a tachometer count value. Before selecting this mode by setting bits [7:5] of configuration register 1 (00h) to 0x1, the desired tachometer count value should be written to the fan tachometer high-limit register (10h). In this mode, the MAX6653/MAX6663/MAX6664 are not able to detect underspeed fan faults because the fan tachometer high-limit register (10h) functions as the target tachometer count.

The MAX6653/MAX6663/MAX6664 detect fan stall faults by comparing the fan-speed reading to the full-scale constant of 254 (FEh). Therefore, the MAX6653/MAX6663/MAX6664 signal a fan fault when the fan-speed reading is 255 (FFh). Note that the RPM mode cannot be used for speeds below 10% of the fan's maximum speed. It is important to verify that a fan works properly at lower RPM values if a low-RPM operation in this mode is desired.

**Table 7. Setting PWM Output Frequency**

FAN CHARACTERISTICS REGISTER (20H) POR = 011			PWM FREQUENCY (Hz)
BIT 5	BIT 4	BIT 3	
0	0	0	11.7
0	0	1	15.6
0	1	0	23.4
<b>0</b>	<b>1</b>	<b>1</b>	<b>31.25</b>
1	0	0	37.5
1	0	1	46.9
1	1	0	62.5
1	1	1	93.5

**Table 8. Setting the Fan-Speed Control Mode (Default = 100)**

Bits [7:5]	MODE OF OPERATION	DESCRIPTION
0x0	PWM duty-cycle mode	Directly program the PWM duty cycle by writing to bits [3:0] of the fan-speed configuration register (22h).
0x1	RPM select mode	Program the desired fan speed by writing to the fan tachometer high-limit register (10h). This value should be written after selecting the RPM mode. The MAX6653/MAX6663/MAX6664 then adjust the PWM duty cycle to cause the fan to spin at the programmed speed.
100	Automatic mode	PWM duty cycle is automatically controlled by the remote temperature.
111	Automatic mode	PWM duty cycle is automatically controlled by both the remote and the local temperatures. See the <i>Automatic Fan-Control Mode</i> section.

# Temperature Monitors and PWM Fan Controllers

**Table 9. Setting PWM Duty Cycle**

BITS [3:0] OF FAN-SPEED CONFIGURATION REGISTER (22h)				% DUTY CYCLE (%)
BIT 3	BIT 2	BIT 1	BIT 0	
0	0	0	0	0
0	0	0	1	7
0	0	1	0	14
0	0	1	1	20
0	1	0	0	27
<b>0</b>	<b>1</b>	<b>0</b>	<b>1</b>	<b>33</b>
0	1	1	0	40
0	1	1	1	47
1	0	0	0	53
1	0	0	1	60
1	0	1	0	67
1	0	1	1	73
1	1	0	0	80
1	1	0	1	87
1	1	1	0	93
1	1	1	1	100

**Automatic Fan-Control Mode**

Automatic fan-speed control is selected by setting bits [7:5] of configuration register 1 (00h) to 100 (to control speed based on the remote temperature) or 101 (to control speed based on both remote and local temperature). Program a threshold, or starting temperature T<sub>MIN</sub>, and the desired temperature range, TRANGE, into the local temp T<sub>MIN</sub>/TRANGE register (24h) for local temperature and into the remote temp T<sub>MIN</sub>/TRANGE register (25h) for remote temperature (Tables 10 and 11). If the fan control responds to both local and remote temperatures, the higher PWM duty cycle has priority.

**Table 10. TRANGE Fan-Control Temperature Range Bits [2:0] T<sub>MIN</sub>/TRANGE Registers (24h and 25h)—POR = 001**

BIT 2	BIT 1	BIT 0	TEMPERATURE RANGE (°C)
0	0	0	5
<b>0</b>	<b>0</b>	<b>1</b>	<b>10</b>
0	1	0	20
0	1	1	40
1	0	0	80

When the temperature exceeds T<sub>MIN</sub>, the fan is enabled at a minimum duty cycle programmed in bits [3:0] of the fan-speed configuration register (22h). The duty cycle increases in proportion to the temperature difference and reaches 100% at a temperature equal to (T<sub>MIN</sub> + TRANGE). A hysteresis of 5°C is built into the T<sub>MIN</sub> set point to prevent the fan from starting and stopping when the temperature is at the set point.

**Spin-Up**

To ensure proper fan startup, the MAX6653/MAX6663/MAX6664 can be set to drive the fan to 100% duty cycle for a short period on startup, and then revert to the correct duty cycle. The spin-up time is programmed by bits [2:0] in the fan characteristics register (20h). The spin-up feature can be disabled by setting bit 7 of the fan-filter register (23h) to 1; POR value is zero. Table 12 shows programming of the spin-up time.

**Fan-Filter Mode**

When the MAX6653/MAX6663/MAX6664 are used for automatic fan-speed control, the fan-filter mode helps minimize the audible effects of varying fan speeds. The fan-filter mode limits the rate at which fan speed can change. Each time a new temperature measurement is made, the fan-filter mode allows the PWM duty cycle to increment by a selectable amount. The duty cycle can change by 1/240, 2/240, 4/240, or 8/240 (0.416%, 0.833%, 1.667%, or 3.333%) of the PWM period after each temperature-monitoring cycle. This prevents sudden changes in fan speed, even when temperature changes suddenly.

The filter mode is set by bit 0 of the fan-filter register (23h). To enable the fan-filter mode, write a 1 to this bit. Bits [6:5] of the same register control the size of the PWM steps.

Note that the rate of change depends on both the value selected by the fan-filter bits and on the temperature

**Table 11. T<sub>MIN</sub> Fan-Control Start Temperature; Bits [7:3] T<sub>MIN</sub>/TRANGE Registers (24h—POR = 01000 and 25h—POR = 01100**

BIT 7	BIT 6	BIT 5	BIT 4	BIT 3
MSB = +64°C				LSB = +4°C
Min threshold = 0°C Max threshold = +127°C LSB/step size = +4°C POR = +48°C or 01100b				

# Temperature Monitors and PWM Fan Controllers

**Table 12. Spin-Up Time; Bits [2:0] Fan Characteristics Register (20h)—POR = 101**

BIT 2	BIT 1	BIT 0	SPIN-UP TIME (s)
0	0	0	0.2
0	0	1	0.4
0	1	0	0.6
0	1	1	0.8
1	0	0	1
<b>1</b>	<b>0</b>	<b>1</b>	<b>2</b>
1	1	0	4
1	1	1	8

**Table 13. Fan Filter Ramp Rate; Bits [6:5] Fan Filter Register (23h)—POR = 10;**

BIT 6	BIT 5	RAMP RATE (x100% / 240)	RAMP RATE (% DUTY CYCLE)
0	0	1	0.416
0	1	2	0.833
<b>1</b>	<b>0</b>	<b>4</b>	<b>1.667</b>
1	1	8	3.333

measurement rate, which is controlled by bits [4:2] of the fan-filter register (23h). Table 5 shows the effect of the temperature measurement rate control bits. As an example, assume that the temperature measurement rate is 2Hz, or 0.5s per monitoring cycle, and the fan-filter rate is 0.416% per monitoring cycle. For the fan drive to change from 50% to 100% requires 50% / 0.416% = 120 temperature monitoring cycles. Thus, for a temperature-monitoring cycle of 0.5s, the time required for the drive to change from 50% to 100% is 60s.

### Fan-Speed Measurement

The fan speed is measured by using the relatively slow tachometer signal from the fan to gate an 11.25kHz

clock frequency into a fan-speed counter. The measurement is initialized on the starting edge of a PWM output if fan-speed measurement is enabled by setting bit 2 of configuration register 2 (01h) to 1. Counting begins on the leading edge of the second tachometer pulse and lasts for two tachometer periods or until the counter overranges (255). The measurement repeats unless monitoring is disabled by resetting bit 2 in the configuration register 2 (01h). The measured result is stored in the fan-speed reading register (08h).

The fan-speed count is given by:

$$\text{Count} = \frac{675,000}{\text{RPM} \times N}$$

where RPM = fan speed in RPM.

N determines the speed range and is programmed by bits [7:6] in the fan characteristics register (20h) as shown in Table 14. When the speed falls below the value in the speed range column, a fan failure is detected.

The TACH/AIN input can be either a digital signal (from the fan's tachometer output) or an analog signal, depending on the setting of bit 2 of the configuration register 1 (00h). The default setting is zero, which sets up TACH/AIN as a digital input. For the analog input (Figure 4), the detected voltage threshold is typically at 250mV, which is appropriate for sensing the voltage of a sense resistor connected to the ground lead of a 2-wire fan. The AIN input only responds to pulse widths greater than 10μs.

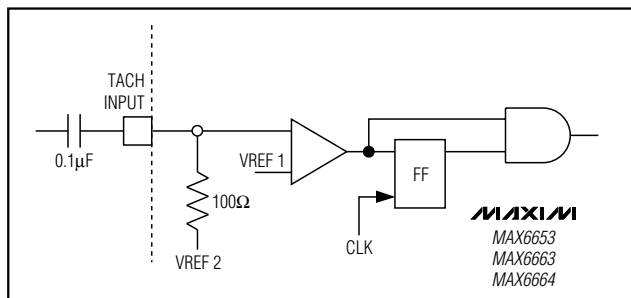

Figure 4. Simplified Tachometer Analog Input Structure

**Table 14. N Factor for Speed-Range Adjustment (Assuming Two Tachometer Pulses per Revolution)**

FAN CHARACTERISTICS REGISTER (20h) POR = 01		N	SPEED RANGE (FAIL SPEED) (RPM)
BIT 7	BIT 6		
0	0	1	2647
<b>0</b>	<b>1</b>	<b>2</b>	<b>1324</b>
1	0	4	662
1	1	8	331

# Temperature Monitors and PWM Fan Controllers

Figure 5 shows a schematic using a current-sensing resistor and a coupling capacitor to derive the tachometer information from the power-supply current of a 2-wire fan. This circuit allows the speed of a 2-wire fan to be measured even though the fan has no tachometer signal output. The sensing resistor, R<sub>SENSE</sub>, converts the fan commutation pulses into a voltage and this voltage is AC-coupled into the TACH/AIN input through coupling capacitor C1. The value of R<sub>SENSE</sub> is on the order of 1Ω to 5Ω, depending on the fan, and the value of the coupling capacitor C1 is 0.01μF. When using this method, set bit 2 of configuration register 1 to 1.

### Fan-Fault Detection

The  $\overline{\text{FAN\_FAULT}}$  output is used to indicate fan slow down or failure. POR disables the  $\overline{\text{FAN\_FAULT}}$  output on the MAX6653/MAX6663. POR enables  $\overline{\text{FAN\_FAULT}}$  output on the MAX6664. If FAN\_FAULT is not enabled, writing a logic 1 to bit 4 of configuration register 1 (00h) enables the  $\overline{\text{FAN\_FAULT}}$  output pin. Either under-speed or stalled fans are detected as fan faults.  $\overline{\text{FAN\_FAULT}}$  is asserted low only when five consecutive interrupts are generated by the MAX6653/MAX6663/MAX6664s'  $\overline{\text{INT}}$  due to fan faults. The MAX6653/MAX6664 apply 100% duty cycle for the duration of the spin-up time once an  $\overline{\text{INT}}$  is asserted. The MAX6663 goes to 100% duty cycle for the duration of the spin-up time once  $\overline{\text{INT}}$  is asserted and status register 1 is read.

Fan-fault detection works by comparing the value of the fan tachometer high-limit register (10h) with the value of the fan-speed reading register (08h), which contains the value of the most recent fan-speed measurement. Note that the value of the fan-speed reading register (08h) must exceed the value of the fan tachometer high limit (10h) by 1 in order to qualify as a fault. The fault generates an interrupt signal by asserting the  $\overline{\text{INT}}$  output, but does not cause the  $\overline{\text{FAN\_FAULT}}$  output to assert until five consecutive failures have been detected. The fan runs at 100% duty cycle when five consecutive failures have been detected, whether  $\overline{\text{FAN\_FAULT}}$  is enabled or not.

As an example of the function of the fan-fault detection, assume a fan is stalled or under speed. The MAX6663 initially indicates the failure by generating an interrupt on the  $\overline{\text{INT}}$  pin. The fan fault bit (bit 1) of interrupt status register 1 (02h) is also set to 1. Once the processor has acknowledged the  $\overline{\text{INT}}$  by reading status register 1, the  $\overline{\text{INT}}$  is cleared. PWM\_OUT is then brought high for a 2s (fan

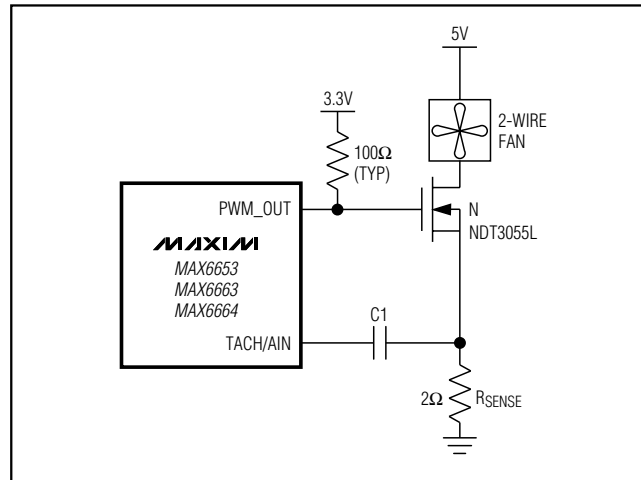

Figure 5. Using the MAX6653/MAX6663/MAX6664 with a 2-Wire Fan

spin-up default, Table 12) spin-up period to restart the fan. Subsequent fan failures cause  $\overline{\text{INT}}$  to be reasserted and PWM\_OUT to be brought high (following a status register 1 read) for a spin-up period each time to restart the fan. Once the fifth tachometer failure occurs, the  $\overline{\text{FAN\_FAULT}}$  is asserted to indicate a critical fan failure.

A MAX6653/MAX6664 example is somewhat simpler. Again assume the fan is stalled or under speed. The MAX6653/MAX6664 initially indicate the failure by generating an interrupt on the  $\overline{\text{INT}}$  pin. The fan fault bit of the interrupt status register is set to 1. PWM\_OUT goes high for the programmed spin-up time (2s default) to restart the fan. Each subsequent fan failure causes another spin-up. Once the fifth tachometer failure occurs, the  $\overline{\text{FAN\_FAULT}}$  output is asserted (if enabled) and the PWM output is driven to 100%.

When the  $\overline{\text{FAN\_FAULT}}$  output is disabled (register 00h, bit 4), spin-ups are still attempted whenever the tach count is greater than the value in the fan tachometer high-limit register (10h). If fan faults and their associated spin-ups are not desired, the fan tachometer high-limit register (10h) to FF. This prevents the tach count from ever exceeding the limit and faults are not detected. Simply disabling the tachometer input (register 01h, bit 2) leaves the fan fault function enabled and can result in fan faults.

# Temperature Monitors and PWM Fan Controllers

## Alarm Speed

For the MAX6663, the alarm speed bit, bit 0 of status register 1 (02h), indicates that the PWM duty cycle is 100%, excluding the case of fan spin-up. For the MAX6653/MAX6664, this bit indicates that the THERM output is low. Once this bit is set, the only way to clear it is by reading status register 1. However, the bit does not reassert on the next monitoring cycle if the condition still exists. It does assert if the condition is discontinued and then returns.

## Power-On Default Conditions

At power-up, the MAX6653/MAX6663/MAX6664 are monitoring temperature to protect the system against thermal damage. The PWM outputs are in known states. Note that although the "Monitoring" bit (Configuration register 1, Bit 0) is enabled, automatic fan speed control does not begin until a 1 is rewritten to Bit 0.

Other default conditions as listed in the *Register Summary* section.

After applying power to the MAX6653/MAX6663/MAX6664, set the desired operating characteristics (fan configuration, alarm thresholds, etc.). Write to Configuration register 1 last. When a 1 is first written to Bit 0 of this register, fan control will commence as determined by the register contents.

## PC Board Layout

Follow these guidelines to reduce the measurement error of the temperature sensors:

- 1) Place the MAX6653/MAX6663/MAX6664 as close as is practical to the remote diode. In noisy environments, such as a computer motherboard, this distance can be 4in to 8in (typ). This length can be increased if the worst noise sources are avoided. Noise sources include CRTs, clock generators,

memory buses, and ISA/PCI buses.

- 2) Do not route the DXP-DXN lines next to the deflection coils of a CRT. Also, do not route the traces across fast digital signals, which can easily introduce 30°C error, even with good filtering.
- 3) Route the DXP and DXN traces in parallel and in close proximity to each other, away from any higher voltage traces, such as 12VDC. Leakage currents from PC board contamination must be dealt with carefully since a 20MΩ leakage path from DXP to ground causes about 1°C error. If high-voltage traces are unavoidable, connect guard traces to GND on either side of the DXP-DXN traces (Figure 6).
- 4) The 10-mil widths and spacing recommended in Figure 6 are not absolutely necessary, as they offer only a minor improvement in leakage and noise over narrow traces. Use wider traces when practical.
- 5) Add a 200Ω resistor in series with VCC for best noise filtering (see *Typical Operating Circuits*).

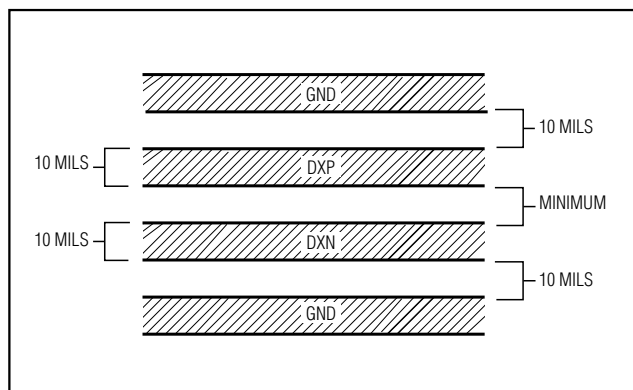

Figure 6. Recommended DXP/DXN PC Traces

Table 15. Power-On Default Conditions

	MAX6653	MAX6663	MAX6664
Temperature Monitoring	Monitoring at 4Hz	Monitoring at 4Hz	Monitoring at 4Hz
PWM Output	Low	High	High
PWM Mode	PWM duty cycle control mode	PWM duty cycle control mode	Automatic fan speed control mode
Duty cycle setting (not enabled until a 1 is written to Bit 0 of Register 00h)	33%	100%	Automatic
PWM Polarity	Inverted (100% duty cycle = output high)	Not Inverted (100% duty cycle = output low)	Not Inverted (100% duty cycle = output low)

# Temperature Monitors and PWM Fan Controllers

## Register Summary

MAX6653/MAX6663/MAX6664

Addr(H)	READ/WRITE	POR STATE	DESCRIPTION
00	R/W	<p>MAX6653 0000 1001</p> <p>MAX6663 00000001</p> <p>MAX6664 10010001</p>	<p><b>Configuration register 1:</b></p> <p>Bits [7:5]: <b>Setting the fan-speed control mode:</b></p> <p>Bit 7 = 1: Enables automatic fan-speed control mode.</p> <p>Bits [6:5] = 00: Remote temperature controls the fan speed.</p> <p>Bits [6:5] = 11: Both remote and local temperature control the fan speed.</p> <p>Bit 7 = 0, Enables PWM control mode or RPM control mode.</p> <p>Bits [6:5] = X0: PWM duty cycle control mode.</p> <p>Bits [6:5] = X1: RPM control mode.</p> <p>Bit 4: <b>FAN_FAULT output enable:</b></p> <p>1: <math>\overline{\text{FAN\_FAULT}}</math> output enabled; 0: (default) <math>\overline{\text{FAN\_FAULT}}</math> output disabled.</p> <p>Bit 3: <b>Invert the PWM output:</b></p> <p>0: (default) PWM active low; 1: (inverted) PWM active high.</p> <p>Bit 2: <b>TACHOMETER digital/analog input selection:</b></p> <p>0: (default) TACHOMETER is a logic input; 1: TACHOMETER is an analog input.</p> <p>Bit 1: <b><math>\overline{\text{INT}}</math> output enable:</b></p> <p>0: <math>\overline{\text{INT}}</math> output disabled; 1: <math>\overline{\text{INT}}</math> output enabled.</p> <p>Bit 0: <b>Monitoring:</b></p> <p>0: sleep mode; 1: (default) active temperature monitoring and fan-speed control. (Keep this bit set to 1 for MAX6663.) Although the default value of this bit is 1, fan speed control for the MAX6653 and MAX6664 is inactive until a 1 is written to this bit.</p>
01	R/W	0111 1111	<p><b>Configuration register 2:</b></p> <p>Bit 7: <b>Reset:</b></p> <p>Setting this bit to 1 restores all registers to POR default states; self-clears to zero after reset.</p> <p>Bit 6: <b>Unused.</b></p> <p>Bit 5: <b>Remote temperature enable:</b></p> <p>0: interrupts disabled for remote channel; 1: interrupts enabled for remote channel; defaults to 1 unless a diode fault is detected on power-up.</p> <p>Bit 4: <b>Local temperature enable:</b></p> <p>0: interrupts disabled for local channel; 1: (default) interrupts enabled for local channel.</p> <p>Bit 3: <b><math>\overline{\text{INT}}</math> input function mask:</b></p> <p>0: enable <math>\overline{\text{INT}}</math> input function; 1: (default) disable <math>\overline{\text{INT}}</math> input function.</p> <p>Bit 2: <b>TACHOMETER input enable:</b></p> <p>0: disable TACHOMETER input; 1: (default) enable the TACHOMETER input. (Keep this bit set to 1 for MAX6663.)</p> <p>Bit 1: <b>SMBus timeout enable:</b></p> <p>0: SMBus timeout disabled; 1: (default) SMBus timeout enabled.</p> <p>Bit 0: <b>PWM out enable:</b></p> <p>0: PWM output disabled; 1: (default) PWM output enabled.</p>

# Temperature Monitors and PWM Fan Controllers

## Register Summary (continued)

Addr(H)	READ/WRITE	POR STATE	DESCRIPTION
02	R	0000 0000	<p><b>Status register 1:</b></p> <p>Bit 7: <b>Local temp low:</b> 1: Local temp low interrupt limit has been exceeded. This bit is cleared by reading status register 1 for the MAX6653/MAX6663/MAX6664 or completing an alert response protocol for the MAX6664. This bit is asserted on the next cycle if the local temperature is still less than the limit.</p> <p>Bit 6: <b>Local temp high:</b> 1: Local temp high interrupt limit has been exceeded. This bit is cleared by reading status register 1 for the MAX6653/MAX6663/MAX6664 or completing an alert response protocol for the MAX6664. This bit is asserted on the next cycle if the local temperature is still greater than the limit.</p> <p>Bit 5: <b>Remote-diode error:</b> 1: remote-diode short circuit or open circuit detected.</p> <p>Bit 4: <b>Remote temp THERM:</b> 1: Remote temp THERM limit has been exceeded. This bit is cleared by reading status register 1.</p> <p>Bit 3: <b>Remote temp low:</b> 1: Remote temp low interrupt limit has been exceeded. This bit is cleared by reading status register 1 for the MAX6653/MAX6663/MAX6664 or completing an alert response protocol for the MAX6664. This bit is asserted on the next cycle if the remote temperature is still less than the limit.</p> <p>Bit 2: <b>Remote temp high:</b> 1: Remote temp high interrupt limit has been exceeded. This bit is cleared by reading status register 1 for the MAX6653/MAX6663/ MAX6664 or completing an alert response protocol for the MAX6664. This bit is asserted on the next cycle if the remote temperature is still greater than the limit.</p> <p>Bit 1: <b>Fan fault:</b> 1: The fan is running under speed. This bit is cleared by reading status register 1 or completing an alert response protocol. This bit is asserted again on the next cycle if the fan fault still exists.</p> <p>Bit 0: <b>Alarm speed:</b> For MAX6663, this bit is set to 1 when the PWM duty cycle = 100%. Once read, this bit does not reassert on the next monitoring cycle, even if the condition still exists. It is asserted again if the condition is discontinued and then returns. For the MAX6653/MAX6664, this bit is set to 1 when the THERM output goes to low.</p>
03	R	0000 0000	<p><b>Status register 2:</b></p> <p>Bit 7: <b>THERM:</b> 1: THERM has been pulled low externally. This bit clears on a read of status register 2.</p> <p>Bit 6: <b>Local temp THERM:</b> 1: Local temp THERM limit has been exceeded. This bit is cleared by reading status register 2.</p> <p>Bits [5:0]: <b>Unused.</b></p>
06	R	0000 0000	<p><b>Extended bits of temperature data:</b></p> <p>Bits [7:5]: <b>Extended bits for local temperature data.</b></p> <p>Bits [4:3]: <b>Unused.</b></p> <p>Bits [2:0]: <b>Extended bits for remote temperature data.</b></p>
08	R	1111 1111	<p><b>Fan-speed reading register:</b></p> <p>This register contains the fan-speed tachometer measurement.</p>

# Temperature Monitors and PWM Fan Controllers

## Register Summary (continued)

MAX6653/MAX6663/MAX6664

Addr(H)	READ/WRITE	POR STATE	DESCRIPTION
0A	R	0001 1110 (30°C)	<b>Local temperature data:</b> This register contains the 8 MSBs of the local temperature measurement.
0B	R	0001 1110 (30°C)	<b>Remote temperature data:</b> This register contains the 8 MSBs of the local temperature measurement.
0D	R/W	0000 0000	<b>Local temperature offset:</b> Bit 7: <b>Sign bit;</b> when zero, the offset value in bits [3:0] is added to the measured local temperature reading. When this bit is 1, the offset value in bits [3:0] is subtracted from the local temperature reading. Bits [6:4] <b>Unused.</b> This bits normally reads back zeros. Bits [3:0] <b>Offset value.</b> This is added to or subtracted from the measured local temperature reading.
0E	R/W	0000 0000	<b>Remote temperature offset:</b> Bit 7: <b>Sign bit;</b> When 0, the offset value in bits [3:0] is added to the measured remote temperature reading. When this bit is 1, the offset value in bits [3:0] is subtracted from the remote temperature reading. Bits [6:4] <b>Unused:</b> These bits normally read back zeros. Bits [3:0] <b>Offset value:</b> This is added to or subtracted from the measured remote temperature reading.
10	R/W	1111 1111	<b>Fan tachometer high-limit register:</b> Contains the limit of the fan-speed measurement. It detects a stalled fan if the measured fan-speed data (reg_08h; proportional to fan period) is larger than the limit.
14	R/W	0011 1100 (60°C)	<b>Local temp high limit:</b> Contains the local high-temperature interrupt limit.
15	R/W	0000 0000 (0°C)	<b>Local temp low limit:</b> Contains the local low-temperature interrupt limit.
16	R/W	0100 0110 (70°C)	<b>Local temp THERM limit:</b> Contains the local high-temperature limit for the THERM output. Default is +70°C for the MAX6663/MAX6664; CRIT0 and CRIT1 determine the default value for the MAX6653 (see Table 1).
18	R/W	0101 0000 (80°C)	<b>Remote temp high limit:</b> Contains the remote high-temperature interrupt limit.
19	R/W	0000 0000 (0°C)	<b>Remote temp low limit:</b> Contains the remote low-temperature interrupt limit.
1A	R/W	0110 0100 (100°C)	<b>Remote temp THERM limit:</b> Contains the remote high-temperature limit for the THERM output. Default is +100°C for the MAX6663/MAX6664; CRIT0 and CRIT1 determine the default value for the MAX6653 (see Table 1).
1B	R/W	0101 1111 (95°C)	<b>Local temp shutdown limit:</b> Contains the local high-temperature limit for the SDL output. CRIT0 and CRIT1 determine the default value for the MAX6653 (see Table 1).
1C	R/W	0111 1101 (125°C)	<b>Remote temp shutdown limit:</b> Contains the remote high-temperature limit for the SDR output. CRIT0 and CRIT1 determine the default value for the MAX6653 (see Table 1).

# Temperature Monitors and PWM Fan Controllers

## Register Summary (continued)

Addr(H)	READ/WRITE	POR STATE	DESCRIPTION
20	R/W	0101 1101	<p><b>Fan characteristics register:</b></p> <p>Bits [7:6]: <b>N factor:</b>            These bits contain the N factor for the fan-speed range:            00 = 1 (fail speed = 2647RPM)            01 = 2 (fail speed = 1324RPM) (default)            10 = 4 (fail speed = 662RPM)            11 = 8 (fail speed = 331RPM)</p> <p>Bits [5:3]: <b>PWM frequency:</b>            These bits contain the nominal PWM output frequency:            000 = 11.7Hz            001 = 15.6Hz            010 = 23.4Hz            011 = 31.25Hz (default)            100 = 37.5Hz            101 = 46.9Hz            110 = 62.5Hz            111 = 93.5Hz</p> <p>Bits [2:0]: <b>Spin-up:</b>            These bits contain the fan spin-up time:            000 = 200ms            001 = 400ms            010 = 600ms            011 = 800ms            100 = 1s            101 = 2s (default)            110 = 4s            111 = 8s</p>
22	R/W	MAX6653/ MAX6664 01010101  MAX6663 01011111	<p><b>Fan-speed configuration register:</b></p> <p>Bits [7:4]: <b>Unused.</b></p> <p>Bits [3:0]: <b>PWM duty cycle:</b> These bits contain the PWM duty cycle for the PWM duty cycle fan-control mode. They also contain the minimum duty cycle that is applied to the fan:            0000 = 0% output            0001 = 7% output            0010 = 14% output            0011 = 20% output            0100 = 27% output            0101 = 33% output (default)            0110 = 40% output            0111 = 47% output            1000 = 53% output            1001 = 60% output            1010 = 67% output            1011 = 73% output            1100 = 80% output            1101 = 87% output            1110 = 93% output            1111 = 100% output</p>

# Temperature Monitors and PWM Fan Controllers

## Register Summary (continued)

MAX6653/MAX6663/MAX6664

Addr(H)	READ/WRITE	POR STATE	DESCRIPTION
23	R/W	0101 1101	<p><b>Fan filter register:</b></p> <p>Bit 7: <b>Fan spin-up disable:</b> 0: Spin-up enabled; 1: spin-up disabled.</p> <p>Bits [6:5]: <b>Fan ramp rate:</b> These bits set the amount the PWM duty cycle can change on each monitoring cycle: 00 = 1 (0.416%) 01 = 2 (0.833%) 10 = 4 (1.667%) (default) 11 = 8 (3.333%)</p> <p>Bits [4:2]: <b>Temperature measurement rate (see Table 5).</b></p> <p>Bit 1: <b>Unused.</b></p> <p>Bit 0: <b>Fan filter enable.</b> Setting the bit to 1 enables the fan filter function.</p>
24	R/W	0100 0001	<p><b>Local temp TMIN/ TRANGE register:</b></p> <p>Bits [7:3]: <b>Local TMIN:</b> Contains the temp threshold for the automatic fan-speed control mode. When the local temperature exceeds this value, the PWM output becomes active: 00000 = 0°C 00001 = +4°C   01000 = +32°C (default)   11110 = +120°C 11111 = +124°C</p> <p>Bits [2:0]: <b>Local TRANGE:</b> Contains the local temperature range for automatic fan-speed control mode. When the temperature reaches TMIN + TRANGE, the PWM duty cycle reaches 100%: 000 = +5°C 001 = +10°C (default) 010 = +20°C 011 = +40°C 100 = +80°C</p>
25	R/W	0110 0001	<p><b>Remote temp TMIN/TRANGE register:</b></p> <p>Bits [7:3]: <b>Remote TMIN.</b> Contains the temp threshold for the automatic fan-speed control mode. When the remote temperature exceeds this value, the PWM output becomes active.: 00000 = 0°C 00001 = +4°C   01100 = +48°C (default)   11110 = +120°C 11111 = +124°C</p> <p>Bits [2:0]: <b>Remote TRANGE:</b> Contains the remote temperature range for automatic fan-speed control mode. When the temperature reaches TMIN + TRANGE, the PWM duty cycle reaches 100%: 000 = +5°C 001 = +10°C (default) 010 = +20°C 011 = +40°C 100 = +80°C</p>

# Temperature Monitors and PWM Fan Controllers

## Register Summary (continued)

Addr(H)	READ/WRITE	POR STATE	DESCRIPTION
3D	R	0011 1000	Device ID
3E	R	0100 1101	Manufacturer ID
3F	R/W	1000 0000	<b>THERM behavior/revision:</b> Bit [7]: <b>THERM behavior:</b> 1: enable THERM as an output. 0: disable THERM as an output. Bits [3:0] <b>revision number.</b> *For MAX6663 bit 7 has to be 1 all the time.

### Twisted-Pair and Shielded Cables

Use a twisted-pair cable to connect the remote sensor for remote-sensor distances longer than 8in, or in very noisy environments. Twisted-pair cable lengths can be between 6ft and 12ft before noise introduces excessive errors. For longer distances, the best solution is a shielded twisted pair like that used for audio microphones. For example, Belden 8451 works well for distances up to 100ft in a noisy environment. At the device, connect the twisted pair to DXP and DXN and the shield to GND. Leave the shield unconnected at the remote sensor. For very long cable runs, the cable's parasitic capacitance often provides noise filtering, so the 2200pF capacitor can often be removed or reduced in value.

Cable resistance also affects remote-sensor accuracy. For every 1Ω of series resistance, the error is approximately 0.5°C.

### PC Board Layout Checklist

- Place the MAX6653/MAX6663/MAX6664 close to the remote-sense junction.
- Keep traces away from high voltages (+12V bus).
- Keep traces away from fast data buses and CRTs.
- Use recommended trace widths and spacings.
- Place a ground plane under the traces.
- Use guard traces flanking DXP and DXN and connecting to GND.
- Place the noise filter and the 0.1μF V<sub>CC</sub> bypass capacitors close to the MAX6653/MAX6663/MAX6664.

### Table 16. Remote-Sensor Transistor Manufacturers

MANUFACTURER	MODEL NO.
Central Semiconductor (USA)	CMPT3904
Rohm Semiconductor (USA)	SST3904
Samsung (Korea)	KST3904-TF
Siemens (Germany)	SMBT3904
Zetex (England)	FMMT3904CT-ND

**Note:** Discrete transistors must be diode connected (base shorted to collector).

### Remote Diode Considerations

The accuracy of the remote temperature measurements depends on the ideality factor (n) of the remote "diode" (actually a transistor). The MAX6653/MAX6663/MAX6664 are optimized for n = 1.008, which is the typical value for the Intel Pentium III. A thermal diode on the substrate of an IC is normally a PNP with its collector grounded. DXP should be connected to the anode (emitter) and DXN should be connected to the cathode (base) of this PNP.

When the remote-sensing diode is a discrete transistor, its collector and base should be connected together. Table 16 lists examples of discrete transistors that are appropriate for use with the MAX6653/MAX6663/MAX6664.

The transistor must be a small-signal type with a relatively high forward voltage; otherwise, the A/D input voltage range can be violated. The forward voltage at

# Temperature Monitors and PWM Fan Controllers

MAX6653/MAX6663/MAX6664

the highest expected temperature must be greater than 0.25V at 10 $\mu$ A, and at the lowest expected temperature, the forward voltage must be less than 0.95V at 100 $\mu$ A. Large power transistors must not be used. Also, ensure that the base resistance is less than 100 $\Omega$ . Tight specifications for forward current gain ( $50 < \beta < 150$ , for example) indicate that the manufacturer has good process controls and that the devices have consistent V<sub>BE</sub> characteristics.

Manufacturers of discrete transistors do not normally specify or guarantee ideality factor. This is normally not a problem since good-quality discrete transistors tend to have ideality factors that fall within a relatively narrow range. We have observed variations in remote temperature readings of less than  $\pm 2^{\circ}\text{C}$  with a variety of discrete transistors. Still, it is sound design practice to verify good consistency of temperature readings with several discrete transistors from any manufacturer under consideration.

## Typical Operating Circuits

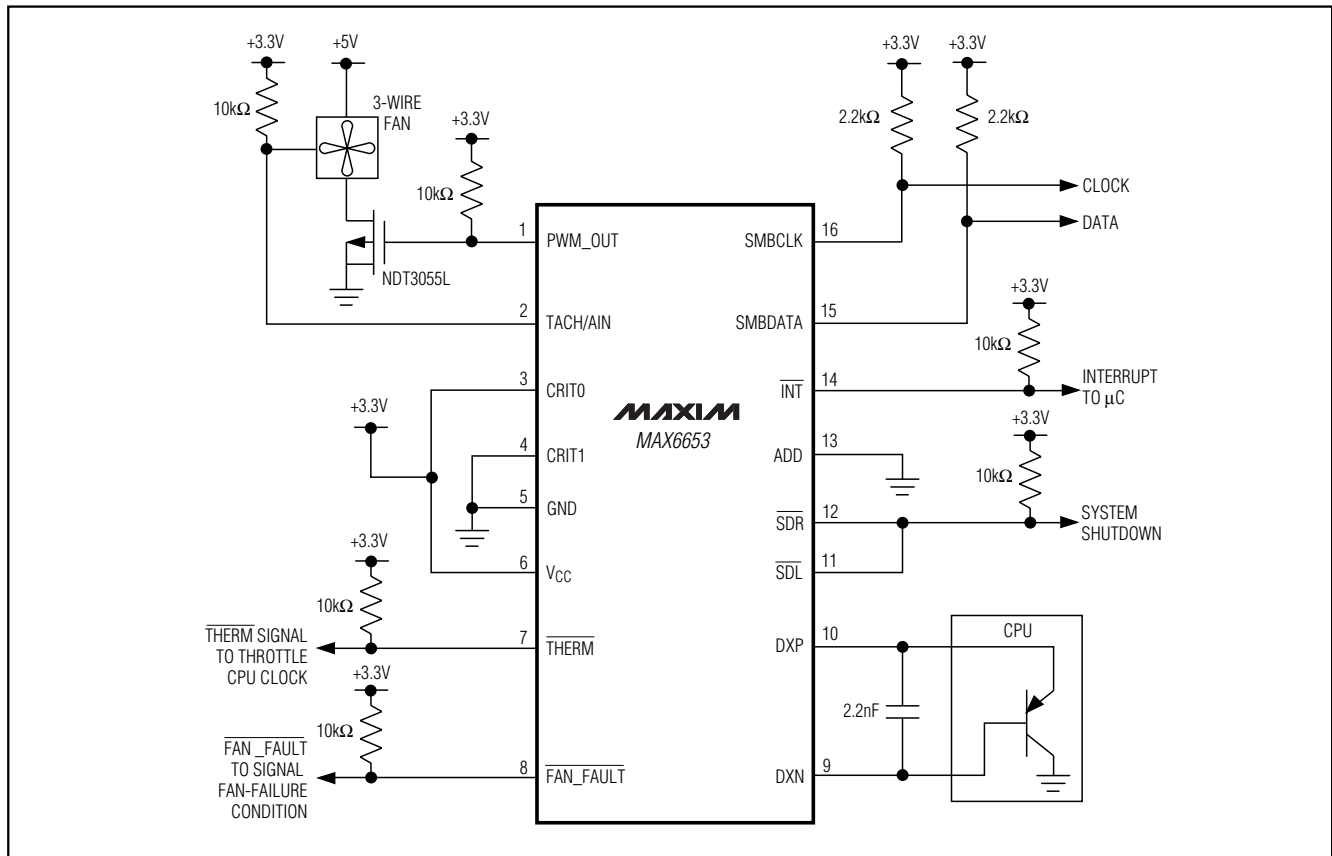

# Temperature Monitors and PWM Fan Controllers

## Typical Operating Circuits (continued)

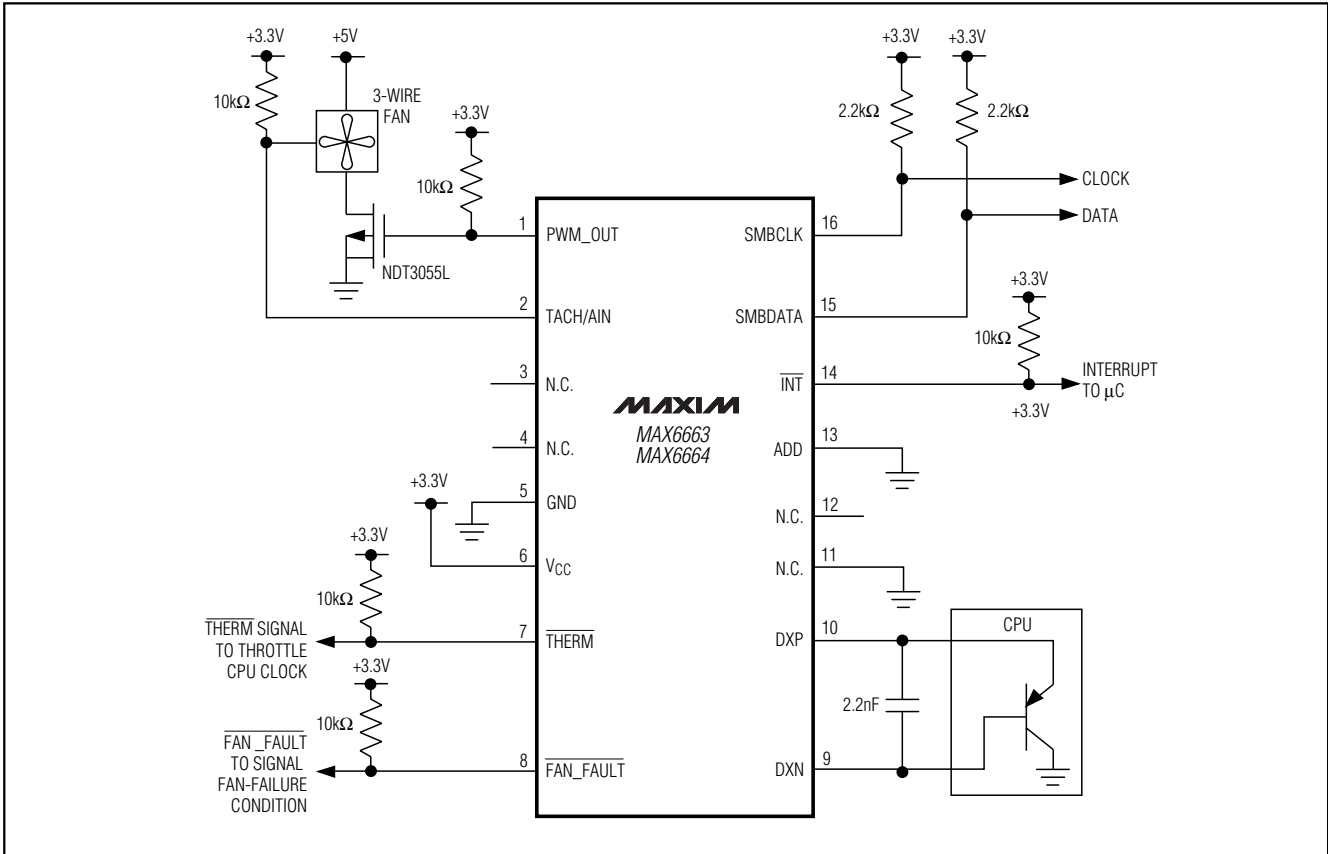

# Temperature Monitors and PWM Fan Controllers

## Functional Diagram

MAX6653/MAX6663/MAX6664

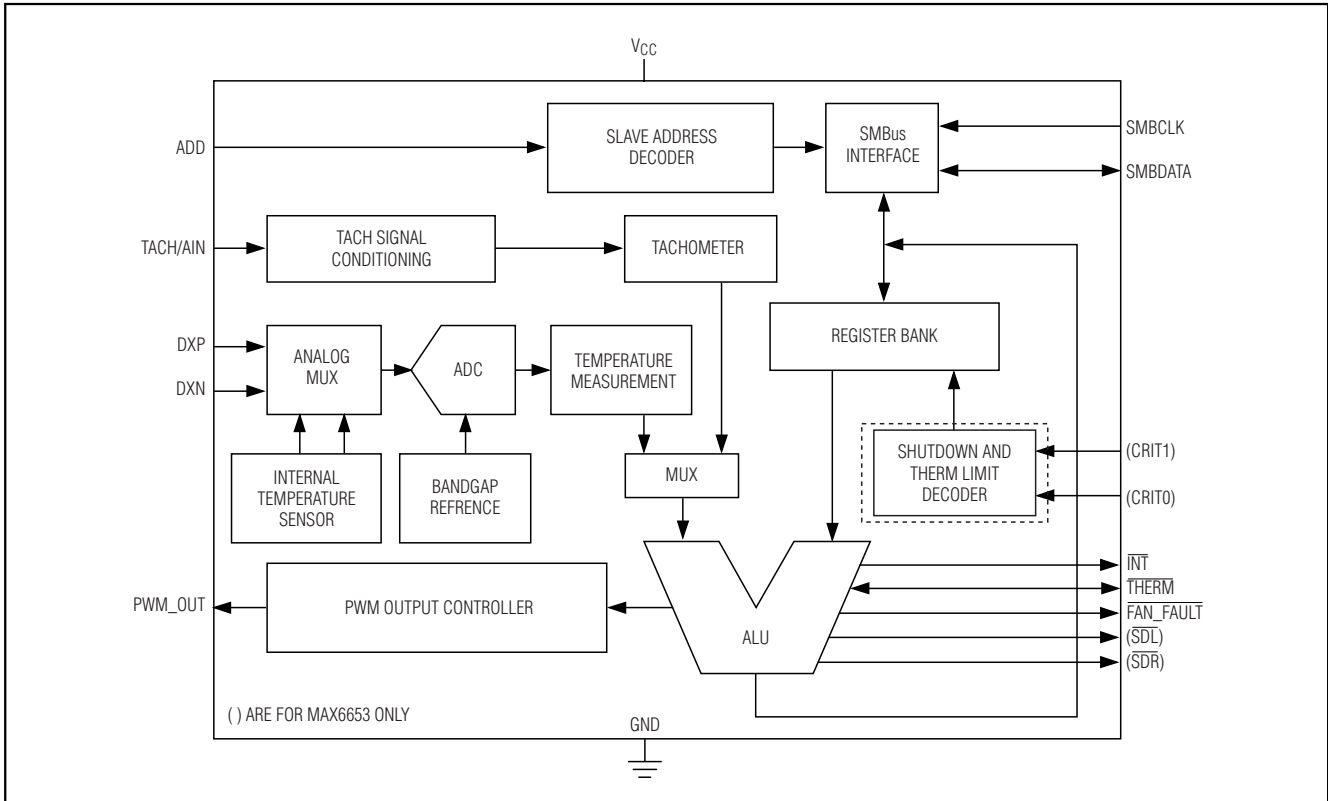

## Pin Configurations (continued)

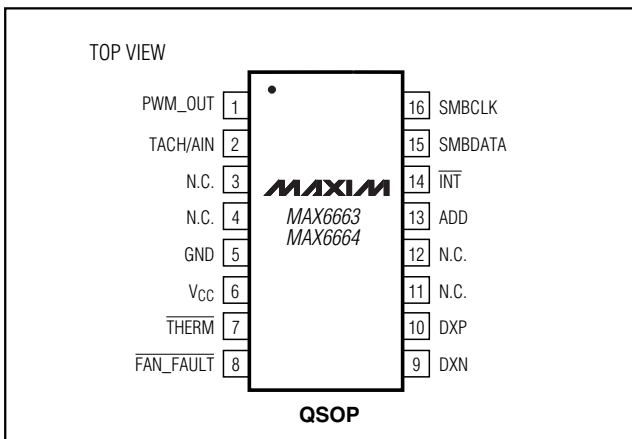

## Chip Information

TRANSISTOR COUNT: 27,074

PROCESS: BiCMOS

# Temperature Monitors and PWM Fan Controllers

## Package Information

(The package drawing(s) in this data sheet may not reflect the most current specifications. For the latest package outline information, go to [www.maxim-ic.com/packages](http://www.maxim-ic.com/packages).)

DIM	INCHES		MILLIMETERS	
	MIN	MAX	MIN	MAX
A	.061	.068	1.55	1.73
A1	.004	.0098	0.102	0.249
A2	.055	.061	1.40	1.55
B	.008	.012	0.20	0.30
C	.0075	.0098	0.191	0.249
D	SEE VARIATIONS			
E	.150	.157	3.81	3.99
e	.025 BSC		0.635 BSC	
H	.230	.244	5.84	6.20
h	.010	.016	0.25	0.41
L	.016	.035	0.41	0.89
N	SEE VARIATIONS			
α	0°	8°	0°	8°

VARIATIONS:

DIM	INCHES		MILLIMETERS		N
	MIN.	MAX.	MIN.	MAX.	
D	.189	.196	4.80	4.98	16 AB
S	.0020	.0070	0.05	0.18	
D	.337	.344	8.56	8.74	20 AD
S	.0500	.0550	1.270	1.397	
D	.337	.344	8.56	8.74	24 AE
S	.0250	.0300	0.635	0.762	
D	.386	.393	9.80	9.98	28 AF
S	.0250	.0300	0.635	0.762	

NOTES:

- 1). D & E DO NOT INCLUDE MOLD FLASH OR PROTRUSIONS.
- 2). MOLD FLASH OR PROTRUSIONS NOT TO EXCEED .006" PER SIDE.
- 3). CONTROLLING DIMENSIONS: INCHES.
- 4). MEETS JEDEC MO137.

**DALLAS SEMICONDUCTOR** **MAXIM**

PROPRIETARY INFORMATION

TITLE: PACKAGE OUTLINE, QSOP .150", .025" LEAD PITCH

APPROVAL	DOCUMENT CONTROL NO. 21-0055	REV. E 1/1
----------	---------------------------------	---------------



QSOP.EPS

Maxim cannot assume responsibility for use of any circuitry other than circuitry entirely embodied in a Maxim product. No circuit patent licenses are implied. Maxim reserves the right to change the circuitry and specifications without notice at any time.

24 \_\_\_\_\_ **Maxim Integrated Products, 120 San Gabriel Drive, Sunnyvale, CA 94086 408-737-7600**

## Looking for pricing, stock, or lifecycle information?

Click below to explore more details on WIN SOURCE:

-  [View MAX6653AEE+T on WIN SOURCE](#)
-  [Maxim Integrated Information](#)

## Optimize Your Supply Chain with WIN SOURCE Solutions

-  Global Sourcing Solution
-  Obsolete Management
-  Cost Control Management
-  Shortage Management
-  Alternative Solution
-  Excess Inventory Management