



**THE DATASHEET OF
MAX6305UK00D3+T**





5-Pin, Multiple-Input, Programmable Reset ICs

MAX6305-MAX6313

General Description

The MAX6305–MAX6313 CMOS microprocessor (μP) supervisory circuits are designed to monitor more than one power supply. Ideal for monitoring both 5V and 3.3V in personal computer systems, these devices assert a system reset if any of the monitored supplies falls outside the programmed threshold. Low supply current (15 μA) and a small package suit them for portable applications. The MAX6305–MAX6313 are specifically designed to ignore fast transients on any monitored supply.

These devices are available in a SOT23-5 package, have factory-programmed reset thresholds from 2.5V to 5.0V (in 100mV increments), and feature four power-on reset timeout periods. Ten standard versions are available. Contact the factory for availability of non standard versions.

Applications

Portable Computers
Computers
Controllers
Intelligent Instruments
Portable/Battery-Powered Equipment
Multivoltage Systems: 3V/5V, 5V/12V, 5V/24V
Embedded Control Systems

Pin Configurations and Typical Operating Circuit appear at end of data sheet.

Ordering Information continued at end of data sheet.

Standard Versions Table appears at end of data sheet.

Features

- ◆ Small 5-Pin SOT23 Package
- ◆ Precision Factory-Set V_{CC} Reset Thresholds; Available in 0.1V Increments from 2.5V to 5V
- ◆ Immune to Short V_{CC} Transients
- ◆ Guaranteed $\overline{\text{RESET}}$ Valid to $V_{CC} = 1\text{V}$
- ◆ Guaranteed Over Temperature
- ◆ 8 μA Supply Current
- ◆ Factory-Set Reset Timeout Delay from 1ms (min) to 1120ms (min)
- ◆ No External Components
- ◆ Manual Reset Input
- ◆ Under/Overvoltage Supply Monitoring

Ordering Information

| PART [†] | TEMP RANGE | PIN-PACKAGE |
|-------------------|----------------|-------------|
| MAX6305UK00D_-T | -0°C to +70°C | 5 SOT23 |
| MAX6305EUK00D_-T | -40°C to +85°C | 5 SOT23 |

[†] The MAX6306/MAX6307/MAX6309/MAX6310/MAX6312/MAX6313 are available with factory-set V_{CC} reset thresholds from 2.5V to 5V, in 0.1V increments. Insert the desired nominal reset threshold (from Table 1) into the blanks following the letters UK. All parts also offer factory-programmed reset timeout periods. Insert the number corresponding to the desired nominal timeout period index following the "D" in the part number (D1 = 1ms min, D2 = 20ms min, D3 = 140ms min, and D4 = 1120ms min). There are 10 standard versions with a required order increment of 2,500 pieces. Sample stock is generally held on the standard versions only (see Standard Versions table). Required order increment is 10,000 pieces for non-standard versions. Contact factory for availability of non-standard versions. All devices available in tape-and-reel only.

Devices are available in both leaded and lead-free packaging. Specify lead-free by replacing "-T" with "+T" when ordering.

Selector Table

| PART | OPEN-DRAIN RESET OUTPUT | PUSH/PULL RESET OUTPUT | PUSH/PULL RESET OUTPUT | FACTORY- SET RESET THRESHOLD ON V_{CC} | ADDITIONAL UNDERVOLTAGE RESET INPUTS | NEGATIVE/ OVERVOLTAGE RESET INPUT | MANUAL- RESET INPUT |
|---------|-------------------------------|------------------------------|------------------------------|---|--|---|---------------------------|
| MAX6305 | ✓ | — | — | — | 2 | — | — |
| MAX6306 | ✓ | — | — | ✓ | 1 | — | ✓ |
| MAX6307 | ✓ | — | — | ✓ | 1 | ✓ | — |
| MAX6308 | — | ✓ | — | — | 2 | — | — |
| MAX6309 | — | ✓ | — | ✓ | 1 | — | ✓ |
| MAX6310 | — | ✓ | — | ✓ | 1 | ✓ | — |
| MAX6311 | — | — | ✓ | — | 2 | — | — |
| MAX6312 | — | — | ✓ | ✓ | 1 | — | ✓ |
| MAX6313 | — | — | ✓ | ✓ | 1 | ✓ | — |

For pricing, delivery, and ordering information, please contact Maxim Direct at 1-888-629-4642, or visit Maxim's website at www.maxim-ic.com.

5-Pin, Multiple-Input, Programmable Reset ICs

ABSOLUTE MAXIMUM RATINGS

V_{CC}-0.3V to +6V
 All Other Pins.....-0.3V to (V_{CC} + 0.3V)
 Input/Output Current, All Pins20mA
 Rate of Rise, V_{CC}100V/μs
 Continuous Power Dissipation (T_A = +70°C)
 SOT23 (derate 7.1mW/°C above +70°C).....571mW

Operating Temperature Range
 MAX63_ _UK _ _D _-T.....0°C to +70°C
 MAX63_ _EUK _ _D _-T-40°C to +85°C
 Storage Temperature Range-65°C to +160°C
 Lead Temperature (soldering, 10sec)+300°C
 Soldering Temperature (reflow)
 Lead (Pb) - free packages.....+260°C
 Packages containing lead (Pb).....+240°C

Stresses beyond those listed under "Absolute Maximum Ratings" may cause permanent damage to the device. These are stress ratings only, and functional operation of the device at these or any other conditions beyond those indicated in the operational sections of the specifications is not implied. Exposure to absolute maximum rating conditions for extended periods may affect device reliability.

ELECTRICAL CHARACTERISTICS

V_{CC} = +2.5V to +5.5V for the MAX6305/MAX6308/MAX6311, V_{CC} = (V_{TH} + 2.5%) to +5.5V for the MAX6306/MAX6307/MAX6309/
 MAX6310/MAX6312/MAX6313; T_A = -40°C to +85°C; unless otherwise noted. Typical values are at T_A = +25°C.) (Note 1)

| PARAMETER | SYMBOL | CONDITIONS | | MIN | TYP | MAX | UNITS | |
|-----------------------------|----------------------|--|---|---------------------------|---------------------|---------------------------|--------|--|
| V _{CC} Range | | T _A = -40°C to +85°C (Note 2) | | 1.0 | | 5.5 | V | |
| Supply Current | I _{CC} | V _{CC} = 5.5V | | | 8 | 16 | μA | |
| Reset Threshold (Note 3) | V _{TH} | MAX6306/MAX6307/ MAX6309/MAX6310/ MAX6312/MAX6313 | T _A = +25°C | V _{TH} - 1.5% | V _{TH} | V _{TH} + 1.5% | V | |
| | | | T _A = 0°C to +70°C | V _{TH} - 2.5% | V _{TH} | V _{TH} + 2.5% | | |
| | | MAX6306E/MAX6307/ MAX6309E/MAX6310E/ MAX6312E/MAX6313E | T _A = -40°C to +85°C | V _{TH} - 2.5% | V _{TH} | V _{TH} + 2.5% | | |
| Reset Threshold | V _{TH} /°C | | | | 40 | | ppm/°C | |
| Reset Threshold | V _{TH} HYST | | | | 2 x V _{TH} | | mV | |
| Reset Timeout Period | t _{RP} | D1 | | 1.0 | 1.4 | 2.0 | ms | |
| | | D2 | | 20 | 28 | 40 | | |
| | | D3 | | 140 | 200 | 280 | | |
| | | D4 | | 1120 | 1570 | 2240 | | |
| RESET Output Voltage | V _{OL} | MAX6305-MAX6310 | V _{CC} > 4.25V, I _{SINK} = 3.2mA | | | 0.4 | V | |
| | | | V _{CC} > 2.5V, I _{SINK} = 1.2mA | | | 0.3 | | |
| | | | V _{CC} > 1.2V, I _{SINK} = 500μA | | | 0.3 | | |
| | | | V _{CC} > 1.0V, I _{SINK} = 50μA | | | 0.3 | | |
| | V _{OH} | MAX6308/MAX6309/ MAX6310 | V _{CC} > 4.25V, I _{SOURCE} = 800μA | V _{CC} - 1.5 | | | V | |
| | | | V _{CC} > 2.5V, I _{SOURCE} = 500μA | 0.8 x V _{CC} | | | | |
| RESET Output Voltage | V _{OL} | MAX6311/MAX6312/ MAX6313 | V _{CC} > 4.25V, I _{SINK} = 3.2mA | | | 0.4 | V | |
| | | | V _{CC} > 2.5V, I _{SINK} = 1.2mA | | | 0.3 | | |
| | V _{OH} | | V _{CC} > 1.8V, I _{SOURCE} = 150μA | 0.8 x V _{CC} | | | | |
| | | | V _{CC} > 1.0V, I _{SOURCE} = 10μA | 0.8 x V _{CC} | | | | |

5-Pin, Multiple-Input, Programmable Reset ICs

MAX6305-MAX6313

ELECTRICAL CHARACTERISTICS (continued)

$V_{CC} = +2.5V$ to $+5.5V$ for the MAX6305/MAX6308/MAX6311, $V_{CC} = (V_{TH} + 2.5\%)$ to $+5.5V$ for the MAX6306/MAX6307/MAX6309/MAX6310/MAX6312/MAX6313; $T_A = -40^{\circ}C$ to $+85^{\circ}C$; unless otherwise noted. Typical values are at $T_A = +25^{\circ}C$.) (Note 1)

| PARAMETER | SYMBOL | CONDITIONS | MIN | TYP | MAX | UNITS |
|---|----------------|---|---------------------|------|------|------------|
| MANUAL-RESET INPUT (MAX6306/MAX6309/MAX6312) | | | | | | |
| \overline{MR} Input | V_{IL} | $V_{TH} > 4.0V$ | 0.8 | | | V |
| | V_{IH} | | 2.4 | | | |
| | V_{IL} | $V_{TH} < 4.0V$ | $0.3 \times V_{CC}$ | | | |
| | V_{IH} | | $0.7 \times V_{CC}$ | | | |
| \overline{MR} Minimum Input Pulse Width | | $T_A = 0^{\circ}C$ to $+70^{\circ}C$ | 1 | | | μs |
| | | $T_A = -40^{\circ}C$ to $+85^{\circ}C$ | 1.5 | | | |
| \overline{MR} Glitch Rejection | | | 0.1 | | | μs |
| \overline{MR} to Reset Delay | | | 500 | | | nsV |
| \overline{MR} Pullup Resistance | | | 32 | 63.5 | 100 | k Ω |
| ADJUSTABLE RESET COMPARATOR INPUTS | | | | | | |
| RST IN_/OVRST_IN Input Threshold | V_{RSTH} | $T_A = +25^{\circ}C$ | 1.21 | 1.23 | 1.25 | V |
| | | MAX6305-MAX6313, $T_A = 0^{\circ}C$ to $+70^{\circ}C$ | 1.20 | | 1.26 | |
| | | MAX6305E-MAX6313E, $T_A = -40^{\circ}C$ to $+85^{\circ}C$ | 1.20 | | 1.26 | |
| RST IN_/OVRST_IN Input Current | $I_{RST IN_}$ | $0V < V_{RST IN_} < V_{CC} - 0.3V$ (Note 4) | -25 | | +25 | nA |
| RST IN_/OVRST_IN Hysteresis | | | 2.5 | | | mV |

Note 1: Overtemperature limits are guaranteed by design, not production tested.

Note 2: The MAX6305/MAX6308/MAX6311 switch from undervoltage reset to normal operation between $1.5V < V_{CC} < 2.5V$.

Note 3: The MAX6306/MAX6307/MAX6309/MAX6310/MAX6312/MAX6313 monitor V_{CC} through an internal factory-trimmed voltage divider, which programs the nominal reset threshold. Factory-trimmed reset thresholds are available in approximately 100mV increments from 2.5V to 5V (Table 1).

Note 4: Guaranteed by design.

5-Pin, Multiple-Input, Programmable Reset ICs

Typical Operating Characteristics

($V_{CC} = +5V$, $T_A = +25^\circ C$, unless otherwise noted.)

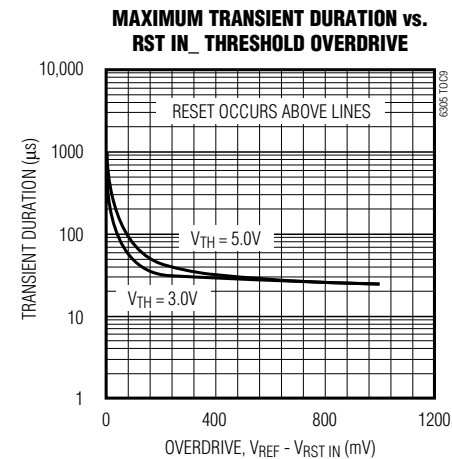
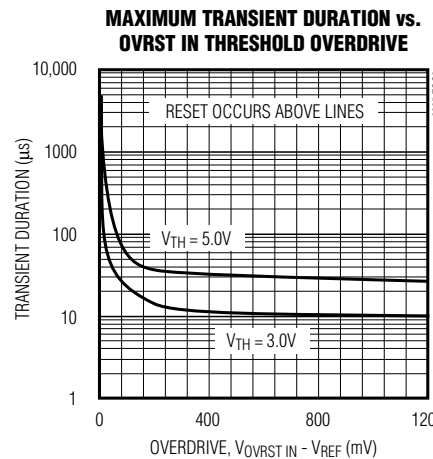
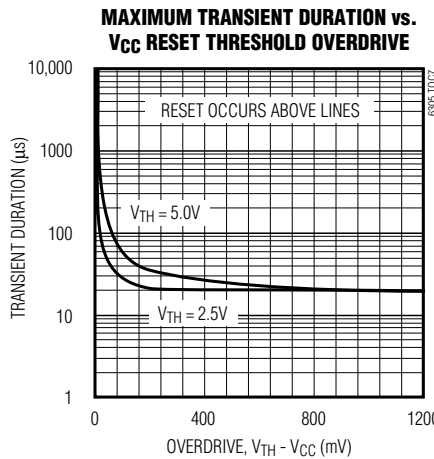
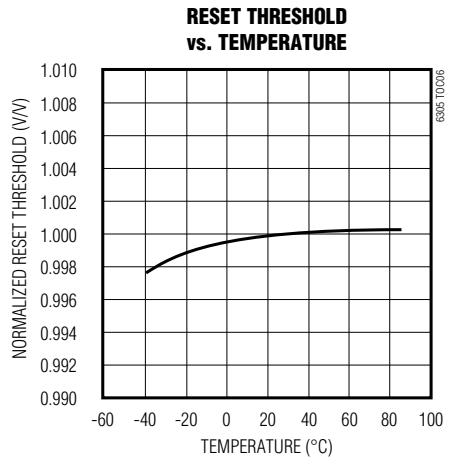
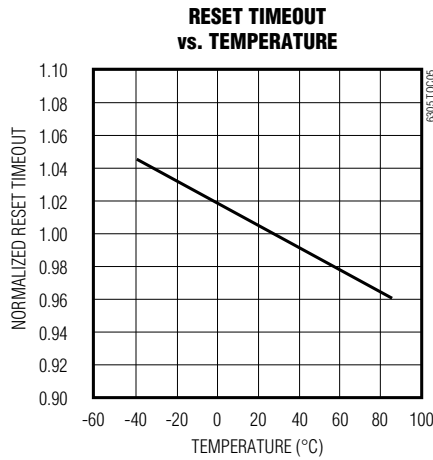
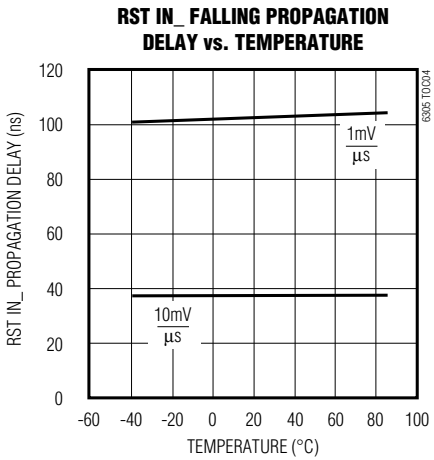
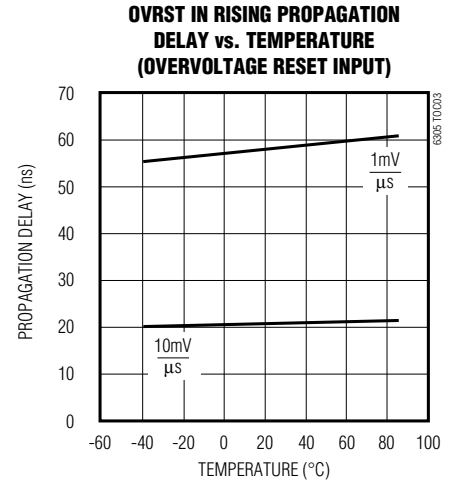
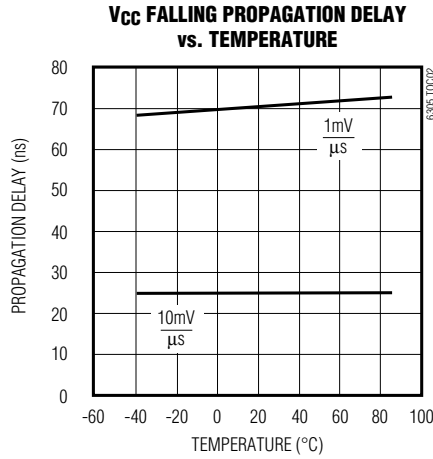
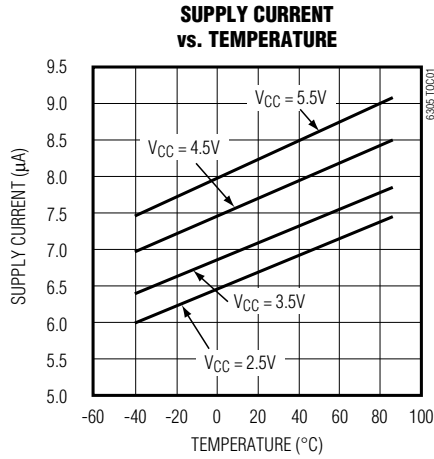

5-Pin, Multiple-Input, Programmable Reset ICs

Pin Description

MAX6305–MAX6313

| PIN | | | NAME | FUNCTION |
|-------------------------------|-------------------------------|-------------------------------|---------------------------|--|
| MAX6305 MAX6308 MAX6311 | MAX6306 MAX6309 MAX6312 | MAX6307 MAX6310 MAX6313 | | |
| 1 | 1 | 1 | $\overline{\text{RESET}}$ | Active-Low, Open-Drain Reset Output for the MAX6305/MAX6306/MAX6307. Active-Low, Push/Pull Reset Output (sources and sinks current) for the MAX6308/MAX6309/MAX6310. |
| | | | RESET | Active-High, Push/Pull Reset Output for the MAX6311/MAX6312/MAX6313 |
| 2 | 2 | 2 | GND | System Ground |
| — | 3 | — | $\overline{\text{MR}}$ | Manual-Reset Input. Pull low to force a reset. $\overline{\text{RESET}}$ /RESET remains active as long as $\overline{\text{MR}}$ is low and for the timeout period after $\overline{\text{MR}}$ goes high. Leave unconnected or connect to V_{CC} if unused. |
| 3, 4 | — | — | RST IN1, RST IN2 | Undervoltage Reset Comparator Input. Asserts reset when the monitored voltage falls below the programmed threshold. Set the reset threshold with an external resistor divider. Connect to V_{CC} if unused. |
| — | 4 | 3 | RST IN | |
| — | — | 4 | OVRST IN | Overvoltage Reset Comparator Input. Asserts reset when the monitored voltage exceeds the programmed threshold. Set the reset threshold with an external resistor divider. Connect to GND if unused. |
| 5 | 5 | 5 | V_{CC} | System Supply. The MAX6306/MAX6307/MAX6309/MAX6310/MAX6312/MAX6313 also monitor V_{CC} through an internal factory-trimmed resistor divider to the reset comparator. |

Detailed Description

The MAX6305–MAX6313 CMOS microprocessor (μP) supervisory circuits are designed to monitor more than one power supply and issue a system reset when any monitored supply falls out of regulation. The MAX6305/MAX6308/MAX6311 have two adjustable undervoltage reset inputs (RST IN1 and RST IN2). The MAX6306/MAX6307/MAX6309/MAX6310/MAX6312/MAX6313 monitor V_{CC} through an internal, factory-trimmed voltage divider. The MAX6306/MAX6309/MAX6312 have, in addition, an adjustable undervoltage reset input and a manual-reset input. The internal voltage divider sets the reset threshold as specified in the device part number (Table 1). The MAX6307/MAX6310/MAX6313 feature an adjustable undervoltage reset input (RST IN) and an adjustable overvoltage reset input (OVRST IN) in addition to the factory-trimmed reset threshold on the V_{CC} monitor. Program the adjustable reset inputs with an external resistor divider (see *Adjustable Reset Inputs* section).

Reset Outputs

A μP 's reset input starts the μP in a known state. These μP supervisory circuits assert reset to prevent code-execution errors during power-up, power-down, or brownout conditions.

$\overline{\text{RESET}}$ (MAX6305–MAX6310) and RESET (MAX6311/MAX6312/MAX6313) are guaranteed to be asserted at a valid logic level for $V_{CC} > 1\text{V}$ (see *Electrical Characteristics*). Once all monitored voltages exceed their programmed reset thresholds, an internal timer keeps reset asserted for the reset timeout period (t_{RP}); after this interval, reset deasserts.

If a brownout condition occurs (any or all monitored voltages dip outside their programmed reset threshold), reset asserts (RESET goes high; $\overline{\text{RESET}}$ goes low). Any time any of the monitored voltages dip below their reset threshold, the internal timer resets to zero and reset asserts. The internal timer starts when all of the monitored voltages return above their reset thresholds, and reset remains asserted for a reset timeout period. The MAX6305/MAX6306/MAX6307 feature an active-low,

5-Pin, Multiple-Input, Programmable Reset ICs



Figure 1. Functional Diagram

open-drain, N-channel output. The MAX6308/MAX6309/MAX6310 feature an active-low, complementary output structure that both sinks and sources current, and the MAX6311/MAX6312/MAX6313 have an active-high complementary reset output.

The MAX6305/MAX6308/MAX6311 switch from under-voltage lockout operation to normal operation between $1.5V < V_{CC} < 2.5V$. Below $1.5V$, V_{CC} undervoltage-lockout mode asserts RESET. Above $2.5V$, V_{CC} normal-operation mode asserts reset if $RST\ IN_$ falls below the $RST\ IN_$ threshold.

Manual-Reset Input (MAX6306/MAX6309/MAX6312)

Many μP -based products require manual-reset capability, allowing an operator or external logic circuitry to initiate a reset. A logic low on \overline{MR} asserts reset. Reset remains asserted while \overline{MR} is low, and for a reset active timeout period (t_{RP}) after \overline{MR} returns high. This input has an internal $63.5k\Omega$ pull-up resistor, so it can be left open if it is not used. \overline{MR} can be driven with TTL-logic levels in 5V systems, with CMOS-logic levels in 3V systems, or with open-drain/collector output devices. Connect a normally open momentary switch from \overline{MR} to GND to create a manual-reset function; external debounce circuitry is not required. If \overline{MR} is driven from long cables or if the device is used in a noisy environment, connecting a $0.1\mu F$ capacitor from \overline{MR} to ground provides additional noise immunity.

The \overline{MR} pin has internal ESD-protection circuitry that may be forward biased under certain conditions, drawing excessive current. For example, assume the circuitry driving \overline{MR} uses a +5V supply other than V_{CC} . If V_{CC} drops or browns out lower than +4.7V, \overline{MR} 's absolute maximum rating is violated ($-0.3V$ to $(V_{CC} + 0.3V)$), and undesirable current flows through the ESD structure from \overline{MR} to V_{CC} . To avoid this, it is recommended that the supply for the \overline{MR} pin be the same as the supply monitored by V_{CC} . In this way, the voltage at \overline{MR} will not exceed V_{CC} .

Adjustable Reset Inputs

The MAX6305-MAX6313 each have one or more reset inputs ($RST\ IN_ / OVRST\ IN$). These inputs are compared to the internal reference voltage (Figure 1). Connect a resistor voltage divider to $RST\ IN_$ such that $V_{RST\ IN_}$ falls below V_{RSTH} ($1.23V$) when the monitored voltage (V_{IN}) falls below the desired reset threshold (V_{TH}) (Figure 2). Calculate the desired reset voltage with the following formula:

$$V_{TH} = \frac{R1 + R2}{R2} \times V_{RSTH}$$

5-Pin, Multiple-Input, Programmable Reset ICs



Figure 2. Increasing Noise Immunity

The $\pm 25\text{nA}$ max input leakage current allows resistors on the order of megohms. Choose the pull-up resistor in the divider to minimize the error due to the input leakage current. The error term in the calculated threshold is simply:

$$\pm 25\text{nA} \times R1$$

If you choose R1 to be $1\text{M}\Omega$, the resulting error is $\pm 25 \times 10^{-9} \times 1 \times 10^6 = \pm 25\text{mV}$.

Like the VCC voltage monitors on the MAX6306/MAX6307/MAX6309/MAX6310/MAX6312/MAX6313, the RST IN_ inputs (when used with a voltage divider) are designed to ignore fast voltage transients. Increase the noise immunity by connecting a capacitor on the order of $0.1\mu\text{F}$ between RST IN and GND (Figure 2). This creates a single-pole lowpass filter with a corner frequency given by:

$$f = (1/2\pi) / (R1 + R2)(R1 \times R2 \times C)$$

For example, if $R1 = 1\text{M}\Omega$ and $R2 = 1.6\text{M}\Omega$, adding a $0.1\mu\text{F}$ capacitor from RST IN_ to ground results in a lowpass corner frequency of $f = 2.59\text{Hz}$. Note that adding capacitance to RST IN slows the circuit's overall response time.

Applications Information

Interfacing to μPs with Bidirectional Reset Pins

Since the $\overline{\text{RESET}}$ output on the MAX6305/MAX6306/MAX6307 is open drain, these devices interface easily with μPs that have bidirectional reset pins, such as the Motorola 68HC11. Connecting the μP supervisor's $\overline{\text{RESET}}$ output directly to the microcontroller's $\overline{\text{RESET}}$ pin with a single pull-up resistor allows either device to assert reset (Figure 3).



Figure 3. Interfacing to μPs with Bidirectional Reset I/O

Negative-Going VCC Transients

In addition to issuing a reset to the μP during power-up, power-down, and brownout conditions, these devices are relatively immune to short-duration, negative-going VCC transients (glitches).

The *Typical Operating Characteristics* show the Maximum Transient Duration vs. VCC Reset Threshold Overdrive, for which reset pulses are not generated. The graph was produced using negative-going pulses, starting at V_{TH} max, and ending below the programmed reset threshold by the magnitude indicated (reset threshold overdrive). The graph shows the maximum pulse width that a negative-going VCC transient may typically have without causing a reset pulse to be issued. As the amplitude of the transient increases (i.e., goes farther below the reset threshold), the maximum allowable pulse width decreases.

RST IN_/OVRST IN are also immune to negative/positive-going transients (see *Typical Operating Characteristics*). A $0.1\mu\text{F}$ bypass capacitor mounted close to the RST IN_, OVRST IN, and/or the VCC pin provides additional transient immunity.

Ensuring a Valid $\overline{\text{RESET}}$ /RESET Output Down to VCC = 0V

When VCC falls below 1V, push/pull structured $\overline{\text{RESET}}$ /RESET current sinking (or sourcing) capabilities decrease drastically. High-impedance CMOS-logic inputs connected to $\overline{\text{RESET}}$ can drift to undetermined voltages. This presents no problem in most applications, since most μPs and other circuitry do not operate with VCC below 1V. In those applications where $\overline{\text{RESET}}$ must be valid down to 0V, adding a pull-down resistor between $\overline{\text{RESET}}$ and ground sinks any stray leakage

5-Pin, Multiple-Input, Programmable Reset ICs

currents, holding $\overline{\text{RESET}}$ low (Figure 4). The pull-down resistor's value is not critical; 100k Ω is large enough not to load $\overline{\text{RESET}}$ and small enough to pull $\overline{\text{RESET}}$ to ground. For applications where $\overline{\text{RESET}}$ must be valid to V_{CC} , a 100k Ω pull-up resistor between $\overline{\text{RESET}}$ and V_{CC} will hold $\overline{\text{RESET}}$ high when V_{CC} falls below 1V (Figure 5).

Since the MAX6305/MAX6306/MAX6307 have open-drain, active-low outputs, they typically use a pull-up resistor. With these devices and under these conditions ($V_{CC} < 1V$), $\overline{\text{RESET}}$ will most likely not maintain an active condition, but will drift toward a nonactive level due to the pull-up resistor and the $\overline{\text{RESET}}$ output's reduction in sinking capability. These devices are not recommended for applications that require a valid $\overline{\text{RESET}}$ output below 1V.



Figure 4. Ensuring $\overline{\text{RESET}}$ Valid to $V_{CC} = 0V$



Figure 5. Ensuring $\overline{\text{RESET}}$ Valid to $V_{CC} = 0V$

Table 1. Factory-Trimmed Reset Thresholds*

| SUFFIX | $T_A = +25^\circ\text{C}$ | | | $T_A = -40^\circ\text{C to } +85^\circ\text{C}$ | |
|--------|---------------------------------------|-------|-------|---|-------|
| | MIN | TYP | MAX | MIN | MAX |
| 00 | Preprogrammed Threshold Not Available | | | Preprogrammed Threshold Not Available | |
| 50 | 4.925 | 5.000 | 5.075 | 4.875 | 5.125 |
| 49 | 4.827 | 4.900 | 4.974 | 4.778 | 5.023 |
| 48 | 4.728 | 4.800 | 4.872 | 4.680 | 4.920 |
| 47 | 4.630 | 4.700 | 4.771 | 4.583 | 4.818 |
| 46 | 4.561 | 4.630 | 4.699 | 4.514 | 4.746 |
| 45 | 4.433 | 4.500 | 4.568 | 4.388 | 4.613 |
| 44 | 4.314 | 4.380 | 4.446 | 4.270 | 4.490 |
| 43 | 4.236 | 4.300 | 4.365 | 4.193 | 4.408 |
| 42 | 4.137 | 4.200 | 4.263 | 4.095 | 4.305 |
| 41 | 4.039 | 4.100 | 4.162 | 3.998 | 4.203 |
| 40 | 3.940 | 4.000 | 4.060 | 3.900 | 4.100 |
| 39 | 3.842 | 3.900 | 3.959 | 3.803 | 3.998 |
| 38 | 3.743 | 3.800 | 3.857 | 3.705 | 3.895 |
| 37 | 3.645 | 3.700 | 3.756 | 3.608 | 3.793 |
| 36 | 3.546 | 3.600 | 3.654 | 3.510 | 3.690 |
| 35 | 3.448 | 3.500 | 3.553 | 3.413 | 3.588 |
| 34 | 3.349 | 3.400 | 3.451 | 3.315 | 3.485 |
| 33 | 3.251 | 3.300 | 3.350 | 3.218 | 3.383 |
| 32 | 3.152 | 3.200 | 3.248 | 3.120 | 3.280 |
| 31 | 3.034 | 3.080 | 3.126 | 3.003 | 3.157 |
| 30 | 2.955 | 3.000 | 3.045 | 2.925 | 3.075 |
| 29 | 2.886 | 2.930 | 2.974 | 2.857 | 3.000 |
| 28 | 2.758 | 2.800 | 2.842 | 2.730 | 2.870 |
| 27 | 2.660 | 2.700 | 2.741 | 2.633 | 2.768 |
| 26 | 2.591 | 2.630 | 2.669 | 2.564 | 2.696 |
| 25 | 2.463 | 2.500 | 2.538 | 2.438 | 2.563 |

* Factory-trimmed reset thresholds are available in approximately 100mV increments with a $\pm 1.5\%$ room-temperature variance.

5-Pin, Multiple-Input, Programmable Reset ICs

MAX6305-MAX6313

Ordering Information (continued)

| PART† | TEMP RANGE | PIN-PACKAGE |
|------------------|----------------|-------------|
| MAX6306UK__D_-T | -0°C to +70°C | 5 SOT23 |
| MAX6306EUK__D_-T | -40°C to +85°C | 5 SOT23 |
| MAX6307UK__D_-T | -0°C to +70°C | 5 SOT23 |
| MAX6307EUK__D_-T | -40°C to +85°C | 5 SOT23 |
| MAX6308UK00D_-T | -0°C to +70°C | 5 SOT23 |
| MAX6308EUK00D_-T | -40°C to +85°C | 5 SOT23 |
| MAX6309UK__D_-T | -0°C to +70°C | 5 SOT23 |
| MAX6309EUK__D_-T | -40°C to +85°C | 5 SOT23 |
| MAX6310UK__D_-T | -0°C to +70°C | 5 SOT23 |
| MAX6310EUK__D_-T | -40°C to +85°C | 5 SOT23 |
| MAX6311UK00D_-T | -0°C to +70°C | 5 SOT23 |
| MAX6311EUK00D_-T | -40°C to +85°C | 5 SOT23 |
| MAX6312UK__D_-T | -0°C to +70°C | 5 SOT23 |
| MAX6312EUK__D_-T | -40°C to +85°C | 5 SOT23 |

† The MAX6306/MAX6307/MAX6309/MAX6310/MAX6312/MAX6313 are available with factory-set V_{CC} reset thresholds from 2.5V to 5V, in 0.1V increments. Insert the desired nominal reset threshold (from Table 1) into the blanks following the letters UK. All parts also offer factory-programmed reset timeout periods. Insert the number corresponding to the desired nominal timeout period index following the "D" in the part number (D1 = 1ms min, D2 = 20ms min, D3 = 140ms min, and D4 = 1120ms min). There are 10 standard versions with a required order increment of 2,500 pieces. Sample stock is generally held on the standard versions only (see Standard Versions table). Required order increment is 10,000 pieces for non-standard versions. Contact factory for availability of non-standard versions. All devices available in tape-and-reel only.

Devices are available in both leaded and lead-free packaging. Specify lead-free by replacing "-T" with "+T" when ordering.

Standard Versions Table

| | |
|-----------------|-----------------|
| MAX6305UK00D3-T | MAX6309UK29D3-T |
| MAX6306UK29D3-T | MAX6309UK46D3-T |
| MAX6306UK46D3-T | MAX6311UK00D3-T |
| MAX6307UK46D3-T | MAX6312UK29D3-T |
| MAX6308UK00D3-T | MAX6312UK46D3-T |

Typical Operating Circuit

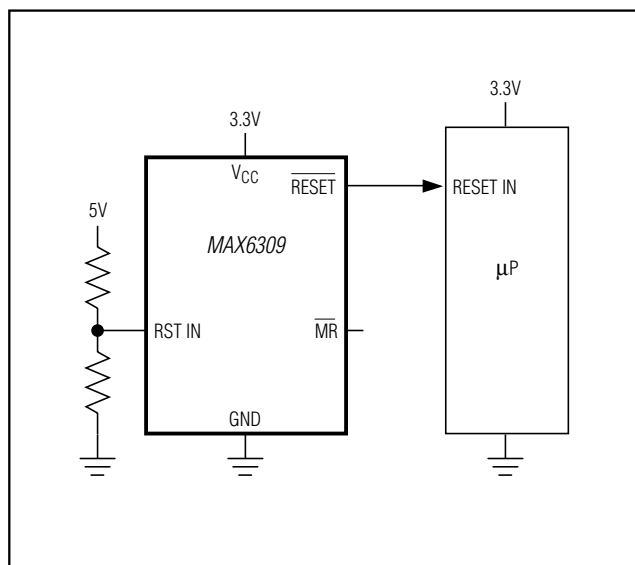

5-Pin, Multiple-Input, Programmable Reset ICs

Pin Configurations

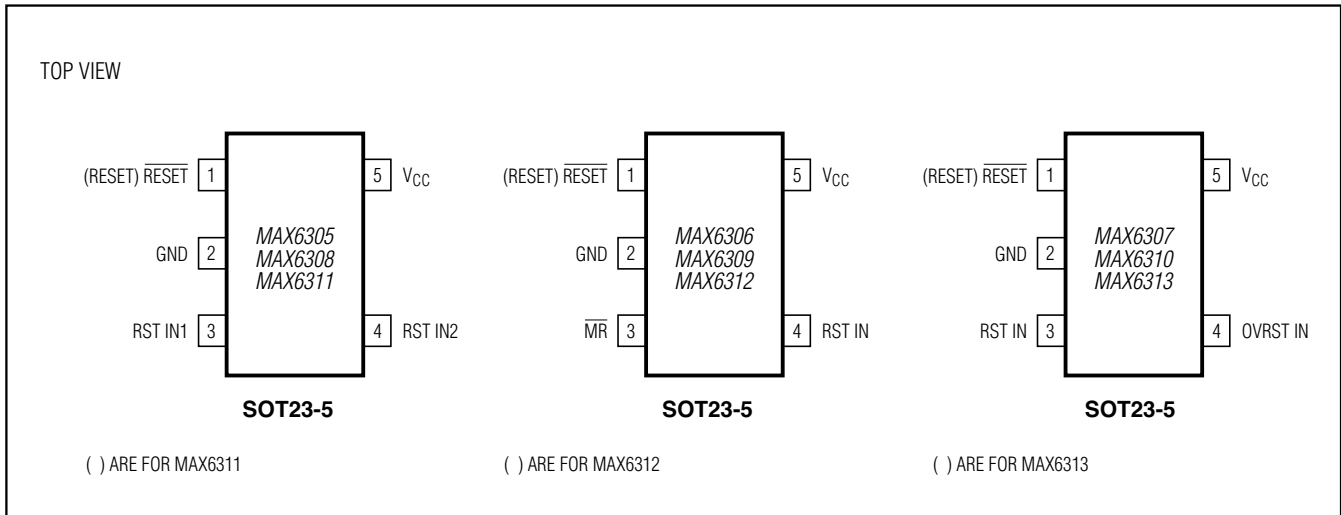

Package Information

For the latest package outline information and land patterns (footprints), go to www.maxim-ic.com/packages. Note that a "+", "#", or "-" in the package code indicates RoHS status only. Package drawings may show a different suffix character, but the drawing pertains to the package regardless of RoHS status.

| PACKAGE TYPE | PACKAGE CODE | OUTLINE NO. | LAND PATTERN NO. |
|--------------|--------------|-------------------------|-------------------------|
| 5 SOT23 | U5+1 | 21-0057 | 90-0174 |

5-Pin, Multiple-Input, Programmable Reset ICs

Revision History

| REVISION NUMBER | REVISION DATE | DESCRIPTION | PAGES CHANGED |
|-----------------|---------------|--|---------------|
| 0 | 9/96 | Initial release | — |
| 1 | 8/98 | Make corrections to EC table and Figures 1 and 8. | 3, 6, 8 |
| 2 | 4/99 | Added Standard Versions Table and note to the <i>Ordering Information</i> table. Text added to the <i>General Description</i> . | 1, 13 |
| 3 | 11/05 | Added lead-free option to the <i>Ordering Information</i> table. | 1, 13 |
| 4 | 12/07 | Updated Table 2 and Package Outline. | 9, 10, 14 |
| 5 | 4/08 | Added MAX6305E-MAX6313E to <i>Ordering Information</i> table, updated <i>Electrical Characteristics</i> table and global conditions, updated Table 1, and removed Table 2. | 1, 2, 3, 8–15 |
| 6 | 7/12 | Updated the <i>Electrical Characteristics</i> table. | 2 |

MAX6305-MAX6313

Maxim cannot assume responsibility for use of any circuitry other than circuitry entirely embodied in a Maxim product. No circuit patent licenses are implied. Maxim reserves the right to change the circuitry and specifications without notice at any time. The parametric values (min and max limits) shown in the Electrical Characteristics table are guaranteed. Other parametric values quoted in this data sheet are provided for guidance.

Maxim Integrated Products, Inc. 160 Rio Robles, San Jose, CA 95134 USA 1-408-601-1000 _____ 11

Looking for pricing, stock, or lifecycle information?

Click below to explore more details on WIN SOURCE:

- ⊖ [View MAX6305UK00D3+T on WIN SOURCE](#)
- ⊖ [Maxim Integrated Information](#)

Optimize Your Supply Chain with WIN SOURCE Solutions

- ✓ Global Sourcing Solution
- ✓ Obsolete Management
- ✓ Cost Control Management
- ✓ Shortage Management
- ✓ Alternative Solution
- ✓ Excess Inventory Management