



**THE DATASHEET OF  
MAX6303CPA+**





# +5V, Low-Power $\mu$ P Supervisory Circuits with Adjustable Reset/Watchdog

## General Description

The MAX6301–MAX6304\* low-power microprocessor ( $\mu$ P) supervisory circuits provide maximum adjustability for reset and watchdog functions. The reset threshold can be adjusted to any voltage above 1.22V, using external resistors. In addition, the reset and watchdog timeout periods are adjustable using external capacitors. A watchdog select pin extends the watchdog timeout period to 500x. The reset function features immunity to power-supply transients.

These four devices differ only in the structure of their reset outputs (see the *Selector Guide*). The MAX6301–MAX6304 are available in the space-saving 8-pin  $\mu$ MAX<sup>®</sup> package, as well as 8-pin PDIP and SO packages.

## Applications

Medical Equipment	Embedded Controllers
Intelligent Instruments	Critical $\mu$ P Monitoring
Portable Equipment	Set-Top Boxes
Battery-Powered	Computers
Computers/Controllers	

## Selector Guide

FEATURE	MAX6301	MAX6302	MAX6303	MAX6304
Active-Low Reset	√	—	√	—
Active-High Reset	—	√	—	√
Open-Drain Reset Output	√	√	—	—
Push-Pull Reset Output	—	—	√	√
Pin-Package	8-PDIP/SO/ $\mu$ MAX	8-PDIP/SO/ $\mu$ MAX	8-PDIP/SO/ $\mu$ MAX	8-PDIP/SO/ $\mu$ MAX

## Pin Configuration

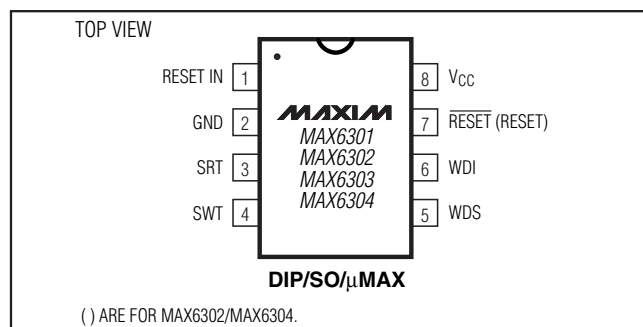

$\mu$ MAX is a registered trademark of Maxim Integrated Products, Inc.



## Features

- ◆ Adjustable Reset Threshold
- ◆ Adjustable Reset Timeout
- ◆ Adjustable Watchdog Timeout
- ◆ 500x Watchdog Timeout Multiplier
- ◆ 4 $\mu$ A Supply Current
- ◆ RESET or  $\overline{\text{RESET}}$  Output Options
- ◆ Push-Pull or Open-Drain Output Options
- ◆ Guaranteed RESET Asserted At or Above  $V_{CC} = 1V$  (MAX6301/MAX6303)
- ◆ Power-Supply Transient Immunity
- ◆ Watchdog Function can be Disabled
- ◆ PDIP/SO/ $\mu$ MAX Packages Available

## Ordering Information

PART	TEMP RANGE	PIN-PACKAGE
MAX6301CPA	0°C to +70°C	8 PDIP
MAX6301CSA	0°C to +70°C	8 SO
MAX6301CUA	0°C to +70°C	8 $\mu$ MAX
MAX6301EPA	-40°C to +85°C	8 PDIP
MAX6301ESA	-40°C to +85°C	8 SO

Devices are available in both leaded and lead(Pb)-free/RoHS-compliant packaging. Specify lead-free by adding the "+" symbol at the end of the part number when ordering.

Ordering Information continued at end of data sheet.

## Typical Operating Circuit



# +5V, Low-Power $\mu$ P Supervisory Circuits with Adjustable Reset/Watchdog

## ABSOLUTE MAXIMUM RATINGS

V <sub>CC</sub> .....	-0.3V to +7.0V	Continuous Power Dissipation (T <sub>A</sub> = +70°C)	
RESET IN, SWT, SRT.....	-0.3V to (V <sub>CC</sub> + 0.3V)	PDI (derate 9.09mW/°C above +70°C).....	727mW
WDI, WDS.....	-0.3V to +7.0V	SO (derate 5.88mW/°C above +70°C).....	471mW
RESET, $\overline{\text{RESET}}$		$\mu$ MAX (derate 4.10mW/°C above +70°C).....	330mW
MAX6301.....	-0.3V to +7.0V	Operating Temperature Range	
MAX6302/MAX6303/MAX6304.....	-0.3V to (V <sub>CC</sub> + 0.3V)	MAX630_C_A.....	0°C to +70°C
Input Current		MAX630_E_A.....	-40°C to +85°C
V <sub>CC</sub> .....	±20mA	Storage Temperature Range.....	-65°C to +160°C
GND.....	±20mA	Lead Temperature (soldering, 10s).....	+300°C
Output Current		Soldering Temperature (reflow)	
RESET, $\overline{\text{RESET}}$ .....	±20mA	Lead(Pb)-free.....	+260°C
		Containing Lead (Pb).....	+240°C

Stresses beyond those listed under "Absolute Maximum Ratings" may cause permanent damage to the device. These are stress ratings only, and functional operation of the device at these or any other conditions beyond those indicated in the operational sections of the specifications is not implied. Exposure to absolute maximum rating conditions for extended periods may affect device reliability.

## ELECTRICAL CHARACTERISTICS

(V<sub>CC</sub> = +2V to +5.5V, T<sub>A</sub> = T<sub>MIN</sub> to T<sub>MAX</sub>, unless otherwise noted. Typical values are at V<sub>CC</sub> = +5V and T<sub>A</sub> = +25°C.)

PARAMETER	SYMBOL	CONDITIONS	MIN	TYP	MAX	UNITS	
Operating Voltage Range (Note 1)	V <sub>CC</sub>	MAX6301C/MAX6303C	1.00		5.50	V	
		MAX6301E/MAX6303E	1.20		5.50		
		MAX6302/MAX6304	1.31		5.50		
Supply Current (Note 2)	I <sub>CC</sub>	No load		4.0	7.0	$\mu$ A	
<b>RESET TIMER</b>							
Reset Input Threshold Voltage	V <sub>TH</sub>	V <sub>RESET IN</sub> falling, V <sub>CC</sub> = 5.0V	1.195	1.220	1.245	V	
		V <sub>RESET IN</sub> rising, V <sub>CC</sub> = 5.0V		1.240	1.265		
Reset Input Hysteresis	V <sub>HYST</sub>			20		mV	
Reset Input Leakage Current	I <sub>RESET IN</sub>			±0.01	±1	nA	
Reset Output-Voltage High (MAX6302/MAX6303/MAX6304)	V <sub>OH</sub>	V <sub>CC</sub> ≥ 4.5V, I <sub>SOURCE</sub> = 0.8mA	V <sub>CC</sub> - 0.4			V	
		V <sub>CC</sub> = 2V, I <sub>SOURCE</sub> = 0.4mA	V <sub>CC</sub> - 0.4				
		MAX6302/MAX6304, V <sub>CC</sub> = 1.31V, R <sub>L</sub> = 10k $\Omega$	V <sub>CC</sub> - 0.3				
Reset Output-Voltage Low (MAX6301/MAX6303/MAX6304)	V <sub>OL</sub>	V <sub>CC</sub> ≥ 4.5V, I <sub>SINK</sub> = 3.2mA			0.4	V	
		V <sub>CC</sub> = 2V, I <sub>SINK</sub> = 1.6mA			0.4		
		MAX6301/ MAX6303	V <sub>CC</sub> = 1V, I <sub>SINK</sub> = 50 $\mu$ A, T <sub>A</sub> = 0°C to +70°C				0.3
			V <sub>CC</sub> = 1.2V, I <sub>SINK</sub> = 100 $\mu$ A, T <sub>A</sub> = -40°C to +85°C				0.3
V <sub>CC</sub> to Reset Delay	t <sub>RD</sub>	V <sub>CC</sub> = falling at 1mV/ $\mu$ s		63		$\mu$ s	
Reset Input Pulse Width	t <sub>RI</sub>	Comparator overdrive = 50mV		26		$\mu$ s	
Reset Timeout Period (Note 3)	t <sub>RP</sub>	C <sub>SRT</sub> = 1500pF	2.8	4.0	5.2	ms	
Reset Output Leakage Current		MAX6301, V <sub>RESET</sub> = V <sub>CC</sub>			±1	$\mu$ A	
		MAX6302, V <sub>RESET</sub> = V <sub>GND</sub>			±1		

# +5V, Low-Power $\mu$ P Supervisory Circuits with Adjustable Reset/Watchdog

MAX6301-MAX6304

## ELECTRICAL CHARACTERISTICS (continued)

( $V_{CC} = +2V$  to  $+5.5V$ ,  $T_A = T_{MIN}$  to  $T_{MAX}$ , unless otherwise noted. Typical values are at  $V_{CC} = +5V$  and  $T_A = +25^\circ C$ .)

PARAMETER	SYMBOL	CONDITIONS	MIN	TYP	MAX	UNITS
<b>WATCHDOG TIMER</b>						
WDI, WDS Input Threshold	$V_{IH}$		$0.7 \times V_{CC}$			V
	$V_{IL}$		$0.3 \times V_{CC}$			
WDI Pulse Width	$t_{WP}$	$V_{CC} = 4.5V$ to $5.5V$	30			ns
		$V_{CC} = 2V$ to $4.5V$	60			
WDI, WDS Leakage Current		Extended mode disabled	$\pm 1$			$\mu A$
WDI Sink/Source Current (Note 4)		Extended mode enabled	$\pm 70$			$\mu A$
Watchdog Timeout Period (Note 3)	$t_{WD}$	WDS = GND, $C_{SWT} = 1500pF$	2.8	4.0	5.2	ms
		WDS = $V_{CC}$ , $C_{SWT} = 1500pF$	1.4	2.0	2.6	s

**Note 1:** Reset is guaranteed valid from the selected reset threshold voltage down to the minimum  $V_{CC}$ .

**Note 2:** WDS =  $V_{CC}$ , WDI unconnected.

**Note 3:** Precision timing currents of 500nA are present at both the SRT and SWT pins. Timing capacitors connected to these nodes must have low leakage consistent with these currents to prevent timing errors.

**Note 4:** The sink/source is supplied through a resistor, and is proportional to  $V_{CC}$  (Figure 8). At  $V_{CC} = 2V$ , it is typically  $\pm 24\mu A$ .

## Typical Operating Characteristics

( $C_{SWT} = C_{SRT} = 1500pF$ ,  $T_A = +25^\circ C$ , unless otherwise noted.)

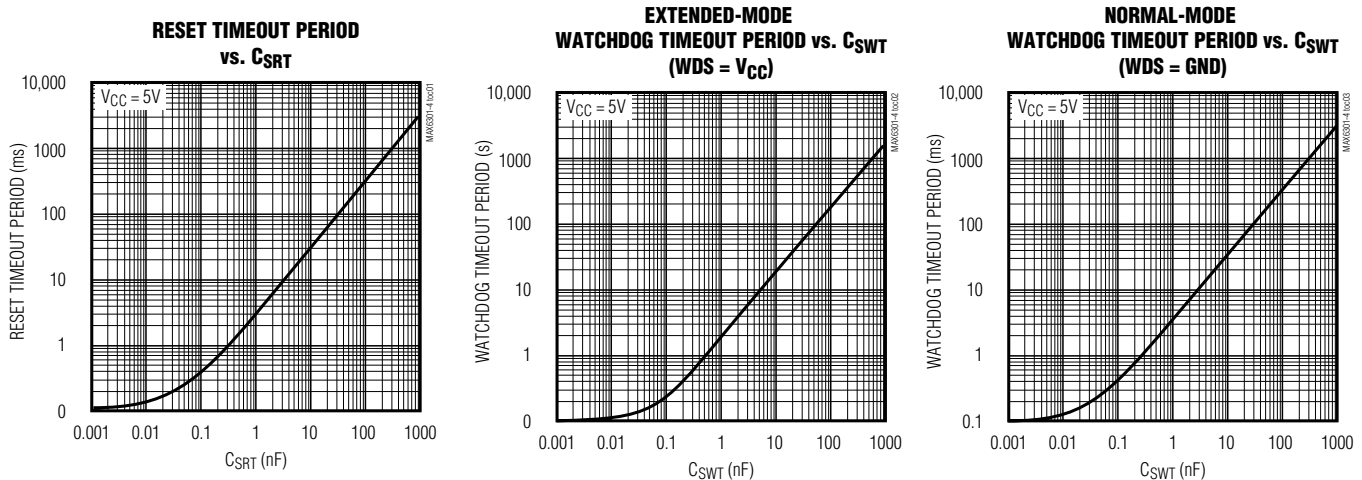

# +5V, Low-Power $\mu$ P Supervisory Circuits with Adjustable Reset/Watchdog

## Typical Operating Characteristics (continued)

( $C_{SWT} = C_{SRT} = 1500\text{pF}$ ,  $T_A = +25^\circ\text{C}$ , unless otherwise noted.)

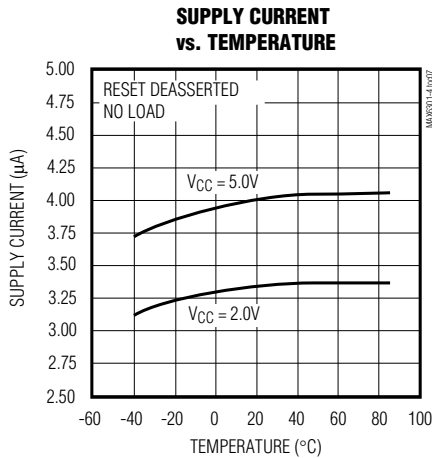
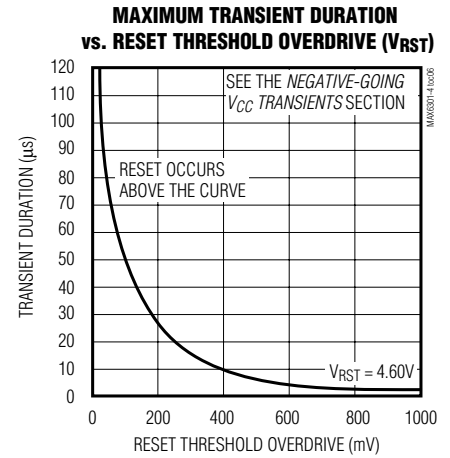
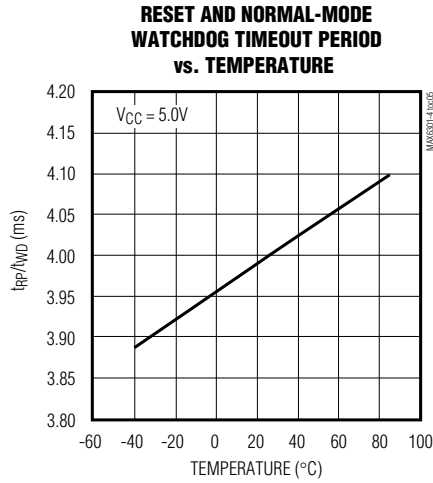
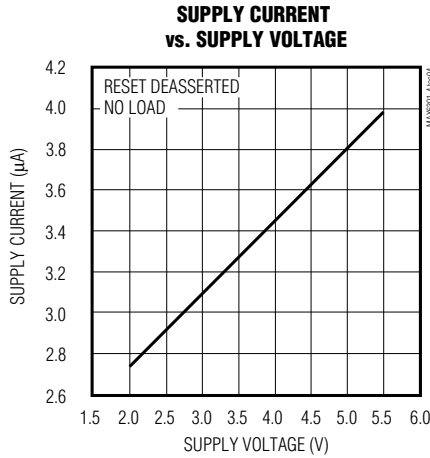

# +5V, Low-Power $\mu$ P Supervisory Circuits with Adjustable Reset/Watchdog

## Pin Description

**MAX6301-MAX6304**

PIN	NAME	FUNCTION		
1	RESET IN	Reset Input. High-impedance input to the reset comparator. Connect this pin to the center point of an external resistor voltage-divider network to set the reset threshold voltage. The reset threshold voltage is calculated as follows: $V_{RST} = 1.22 \times (R1 + R2)/R2$ (see the <i>Typical Operating Circuit</i> ).		
2	GND	Ground		
3	SRT	Set Reset-Timeout Input. Connect a capacitor between this input and ground to select the reset timeout period ( $t_{RP}$ ). Determine the period as follows: $t_{RP} = 2.67 \times C_{SRT}$ , with $C_{SRT}$ in pF and $t_{RP}$ in $\mu$ s (see the <i>Typical Operating Circuit</i> ).		
4	SWT	Set Watchdog-Timeout Input. Connect a capacitor between this input and ground to select the basic watchdog timeout period ( $t_{WD}$ ). Determine the period as follows: $t_{WD} = 2.67 \times C_{SWT}$ , with $C_{SWT}$ in pF and $t_{WD}$ in $\mu$ s. The watchdog function can be disabled by connecting this pin to ground.		
5	WDS	Watchdog-Select Input. This input selects the watchdog mode. Connect to ground to select normal mode and the basic watchdog timeout period. Connect to $V_{CC}$ to select extended mode, multiplying the basic timeout period by a factor of 500. A change in the state of this pin resets the watchdog timer to zero.		
6	WDI	Watchdog Input. A rising or falling transition must occur on this input within the selected watchdog timeout period, or a reset pulse will occur. The capacitor value selected for SWT and the state of WDS determine the watchdog timeout period. The watchdog timer clears and restarts when a transition occurs on WDI or WDS. The watchdog timer is cleared when reset is asserted and restarted after reset deasserts. In the extended watchdog mode ( $WDS = V_{CC}$ ), the watchdog function can be disabled by driving WDI with a three-stated driver or by leaving WDI unconnected.		
7	$\overline{\text{RESET}}$ (MAX6301/ MAX6303)	Open-Drain, Active-Low Reset Output (MAX6301)	$\overline{\text{RESET}}$ changes from high to low whenever the monitored voltage ( $V_{IN}$ ) drops below the selected reset threshold ( $V_{RST}$ ). $\overline{\text{RESET}}$ remains low as long as $V_{IN}$ is below $V_{RST}$ . Once $V_{IN}$ exceeds $V_{RST}$ , $\overline{\text{RESET}}$ remains low for the reset timeout period and then goes high. The watchdog timer triggers a reset pulse ( $t_{RP}$ ) whenever the watchdog timeout period ( $t_{WD}$ ) is exceeded.	
		Push-Pull, Active-Low Reset Output (MAX6303)		
	RESET (MAX6302/ MAX6304)	Open-Drain, Active-High Reset Output (MAX6302)		RESET changes from low to high whenever the monitored voltage ( $V_{IN}$ ) drops below the selected reset threshold ( $V_{RST}$ ). RESET remains high as long as $V_{IN}$ is below $V_{RST}$ . Once $V_{IN}$ exceeds $V_{RST}$ , RESET remains high for the reset timeout period and then goes low. The watchdog timer triggers a reset pulse ( $t_{RP}$ ) whenever the watchdog timeout period ( $t_{WD}$ ) is exceeded.
		Push-Pull, Active-High Reset Output (MAX6304)		
8	$V_{CC}$	Supply Voltage. Bypass to ground with a 0.1 $\mu$ F capacitor placed as close as possible to the pin.		

# +5V, Low-Power $\mu$ P Supervisory Circuits with Adjustable Reset/Watchdog

## Detailed Description

### Reset Function/Output

The reset output is typically connected to the reset input of a  $\mu$ P. A  $\mu$ P's reset input starts or restarts the  $\mu$ P in a known state. The MAX6301–MAX6304  $\mu$ P supervisory circuits provide the reset logic to prevent code-execution errors during power-up, power-down, and brownout conditions (see the *Typical Operating Circuit*).

For the MAX6301/MAX6303,  $\overline{\text{RESET}}$  changes from high to low whenever the monitored voltage ( $V_{\text{IN}}$ ) drops below the reset threshold voltage ( $V_{\text{RST}}$ ).  $\overline{\text{RESET}}$  remains low as long as  $V_{\text{IN}}$  is below  $V_{\text{RST}}$ . Once  $V_{\text{IN}}$  exceeds  $V_{\text{RST}}$ ,  $\overline{\text{RESET}}$  remains low for the reset timeout period, then goes high. When a reset is asserted due to a watchdog timeout condition,  $\overline{\text{RESET}}$  stays low for the reset timeout period. Any time reset asserts, the watchdog timer clears. At the end of the reset timeout period,  $\overline{\text{RESET}}$  goes high and the watchdog timer is restarted from zero. If the watchdog timeout period is exceeded again, then  $\overline{\text{RESET}}$  goes low again. This cycle continues unless WDI receives a transition.

On power-up, once  $V_{\text{CC}}$  reaches 1V,  $\overline{\text{RESET}}$  is guaranteed to be a logic-low. For information about applications where  $V_{\text{CC}}$  is less than 1V, see the *Ensuring a Valid  $\overline{\text{RESET}}$ /RESET Output Down to  $V_{\text{CC}} = 0\text{V}$  (MAX6303/MAX6304)* section. As  $V_{\text{CC}}$  rises,  $\overline{\text{RESET}}$  remains low. When  $V_{\text{IN}}$  rises above  $V_{\text{RST}}$ , the reset timer starts and  $\overline{\text{RESET}}$  remains low. When the reset timeout period ends,  $\overline{\text{RESET}}$  goes high.

On power-down, once  $V_{\text{IN}}$  goes below  $V_{\text{RST}}$ ,  $\overline{\text{RESET}}$  goes low and is guaranteed to be low until  $V_{\text{CC}}$  drops below 1V. For information about applications where  $V_{\text{CC}}$  is less than 1V, see the *Ensuring a Valid  $\overline{\text{RESET}}$ /RESET Output Down to  $V_{\text{CC}} = 0\text{V}$  (MAX6303/MAX6304)* section.

The MAX6302/MAX6304 active-high RESET output is the inverse of the MAX6301/MAX6303 active-low  $\overline{\text{RESET}}$  output, and is guaranteed valid for  $V_{\text{CC}} > 1.31\text{V}$ .

### Reset Threshold

These supervisors monitor the voltage on RESET IN. The MAX6301–MAX6304 have an adjustable reset threshold voltage ( $V_{\text{RST}}$ ) set with an external resistor voltage-divider (Figure 1). Use the following formula to calculate  $V_{\text{RST}}$  (the point at which the monitored voltage triggers a reset):

$$V_{\text{RST}} = \frac{V_{\text{TH}} \times (R1 + R2)}{R2} \quad (\text{V})$$

where  $V_{\text{RST}}$  is the desired reset threshold voltage and  $V_{\text{TH}}$  is the reset input threshold (1.22V). Resistors R1

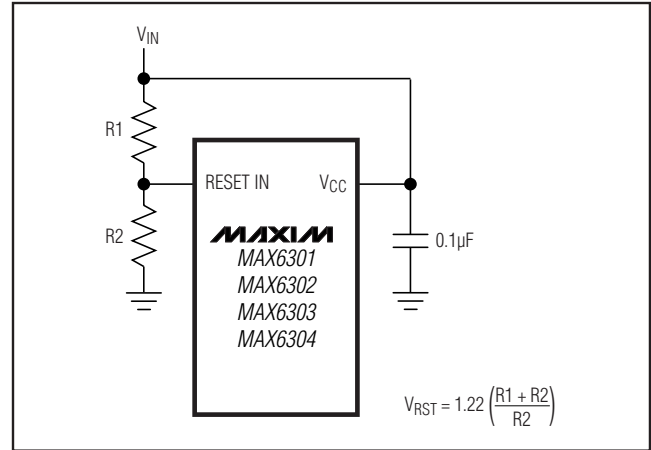

Figure 1. Calculating the Reset Threshold Voltage ( $V_{\text{RST}}$ )

and R2 can have very high values to minimize current consumption. Set R2 to some conveniently high value (1M $\Omega$ , for example) and calculate R1 based on the desired reset threshold voltage, using the following formula:

$$R1 = R2 \times \left( \frac{V_{\text{RST}}}{V_{\text{TH}}} - 1 \right) \quad (\Omega)$$

### Watchdog Timer

The watchdog circuit monitors the  $\mu$ P's activity. If the  $\mu$ P does not toggle the watchdog input (WDI) within  $t_{\text{WD}}$  (user selected), reset asserts. The internal watchdog timer is cleared by reset, by a transition at WDI (which can detect pulses as short as 30ns), or by a transition at WDS. The watchdog timer remains cleared while reset is asserted; as soon as reset is released, the timer starts counting (Figure 2).

The MAX6301–MAX6304 feature two modes of watchdog timer operation: normal mode and extended mode. In normal mode (WDS = GND), the watchdog timeout period is determined by the value of the capacitor connected between SWT and ground (see the *Selecting the Reset and Watchdog Timeout Capacitor* section). In extended mode (WDS =  $V_{\text{CC}}$ ), the watchdog timeout period is multiplied by 500. For example, in the extended mode, a 1 $\mu$ F capacitor gives a watchdog timeout period of 22 minutes (see the Extended-Mode Watchdog Timeout Period vs.  $C_{\text{SWT}}$  graph in the *Typical Operating Characteristics*).

In extended mode, the watchdog function can be disabled by leaving WDI unconnected or by three-stating the driver connected to WDI. In this mode, the watchdog input is internally driven low during the watchdog timeout period, then momentarily pulses high, resetting the

# +5V, Low-Power $\mu$ P Supervisory Circuits with Adjustable Reset/Watchdog



Figure 2a. Watchdog Timing Diagram, WDS = GND



Figure 2b. Watchdog Timing Diagram, WDS = VCC

watchdog counter. When WDI is left unconnected, the watchdog timer is cleared by this internal driver just before the timeout period is reached (the internal driver pulls WDI high at about 94% of  $t_{WD}$ ). When WDI is three-stated, the maximum allowable leakage current of the device driving WDI is 10 $\mu$ A.

In normal mode (WDS = GND), the watchdog timer cannot be disabled by three-stating WDI. WDI is a high-impedance input in this mode. Do not leave WDI unconnected in normal mode.

## Applications Information

### Selecting the Reset and Watchdog Timeout Capacitor

The reset timeout period is adjustable to accommodate a variety of  $\mu$ P applications. Adjust the reset timeout period ( $t_{RP}$ ) by connecting a specific value capacitor ( $C_{SRT}$ ) between SRT and ground (Figure 3). Calculate the reset timeout capacitor as follows:

$$C_{SRT} = t_{RP}/2.67$$



Figure 3. Calculating the Reset ( $C_{SRT}$ ) and Watchdog ( $C_{SWT}$ ) Timeout Capacitor Values

# +5V, Low-Power $\mu$ P Supervisory Circuits with Adjustable Reset/Watchdog



Figure 4. Monitoring Voltages Other than VCC

with CSRT in pF and tRP in  $\mu$ s. CSRT must be a low-leakage (< 10nA) type capacitor. Ceramic is recommended.

The watchdog timeout period is adjustable to accommodate a variety of  $\mu$ P applications. With this feature, the watchdog timeout can be optimized for software execution. The programmer can determine how often the watchdog timer should be serviced. Adjust the watchdog timeout period (tWD) by connecting a specific value capacitor (CSWT) between SWT and ground (Figure 3). For normal-mode operation, calculate the watchdog timeout capacitor as follows:

$$CSWT = tWD / 2.67$$

where CSWT is in pF and tWD is in  $\mu$ s. CSWT must be a low-leakage (< 10nA) type capacitor. Ceramic is recommended.

### Monitoring Voltages Other than VCC

The *Typical Operating Circuit* monitors VCC. Voltages other than VCC can easily be monitored, as shown in Figure 4. Calculate V<sub>RST</sub> as shown in the *Reset Threshold* section.

### Wake-Up Timer

In some applications, it is advantageous to put a  $\mu$ P into sleep mode, periodically wake it up to perform checks and/or tasks, then put it back into sleep mode. The MAX6301 family of supervisors can easily accommodate this technique. Figure 5 illustrates an example using the MAX6302 and an 80C51.

In Figure 5, just before the  $\mu$ C puts itself into sleep mode, it pulls WDS high. The  $\mu$ C's I/O pins maintain their logic levels while in sleep mode and WDS remains high. This places the MAX6302 in extended mode, increasing the watchdog timeout 500 times. When the



Figure 5. Wake-Up Timer

watchdog timeout period ends, a reset is applied on the 80C51, waking it up to perform tasks. While the  $\mu$ P is performing tasks, the 80C51 pulls WDS low (selecting normal mode), and the MAX6302 monitors the  $\mu$ P for hang-ups. When the  $\mu$ P finishes its tasks, it puts itself back into sleep mode, drives WDS high, and starts the cycle over again. This is a power-saving technique, since the  $\mu$ P is operating only part of the time and the MAX6302 has very low quiescent current.

### Adding a Manual Reset Function

A manual reset option can easily be implemented by connecting a normally open momentary switch in parallel with R2 (Figure 6). When the switch is closed, the voltage on RESET IN goes to zero, initiating a reset. When the switch is released, the reset remains asserted for the reset timeout period and then is cleared. The pushbutton switch is effectively debounced by the reset timer.



Figure 6. Adding a Manual Reset Function

# +5V, Low-Power $\mu$ P Supervisory Circuits with Adjustable Reset/Watchdog



Figure 7. Interfacing to  $\mu$ Ps with Bidirectional Reset I/O Pins

## Interfacing to $\mu$ Ps with Bidirectional Reset Pins

Since  $\overline{\text{RESET}}$  is open-drain, the MAX6301 interfaces easily with  $\mu$ Ps that have bidirectional reset pins, such as the Motorola 68HC11 (Figure 7). Connecting  $\overline{\text{RESET}}$  directly to the  $\mu$ P's reset pin with a single pullup allows either device to assert reset.

## Negative-Going Vcc Transients

In addition to issuing a reset to the  $\mu$ P during power-up, power-down, and brownout conditions, these supervisors are relatively immune to short-duration negative-going transients (glitches). The Maximum Transient Duration vs. Reset Threshold Overdrive graph in the *Typical Operating Characteristics* shows this relationship.

The area below the curves of the graph is the region in which these devices typically do not generate a reset pulse. This graph was generated using a negative-going pulse applied to  $V_{IN}$ , starting above the actual reset threshold ( $V_{RST}$ ) and ending below it by the magnitude indicated (reset-threshold overdrive). As the magnitude of the transient increases (farther below the reset threshold), the maximum allowable pulse width decreases. Typically, a  $V_{CC}$  transient that goes 100mV below the reset threshold and lasts 50 $\mu$ s or less will not cause a reset pulse to be issued.



Figure 8. Watchdog Input Structure

## Watchdog Input Current

### Extended Mode

In extended mode ( $\text{WDS} = V_{CC}$ ), the WDI input is internally driven through a buffer and series resistor from the watchdog counter (Figure 8). When WDI is left unconnected, the watchdog timer is serviced within the watchdog timeout period by a very brief low-high-low pulse from the counter chain. For minimum watchdog input current (minimum overall power consumption), leave WDI low for the majority of the watchdog timeout period, pulsing it low-high-low (> 30ns) once within the period to reset the watchdog timer. If instead WDI is externally driven high for the majority of the timeout period, typically 70 $\mu$ A can flow into WDI.

### Normal Mode

In normal mode ( $\text{WDS} = \text{GND}$ ), the internal buffer that drives WDI is disabled. In this mode, WDI is a standard CMOS input and leakage current is typically 100pA, regardless of whether WDI is high or low.

## Ensuring a Valid $\overline{\text{RESET}}$ /RESET Output Down to $V_{CC} = 0\text{V}$ (MAX6303/MAX6304)

When  $V_{CC}$  falls below 1V,  $\overline{\text{RESET}}$ /RESET current sinking (sourcing) capabilities decline drastically. In the case of the MAX6303, high-impedance CMOS-logic inputs connected to  $\overline{\text{RESET}}$  can drift to undetermined voltages. This presents no problem in most applications, since most  $\mu$ Ps and other circuitry do not operate with  $V_{CC}$  below 1V.

## +5V, Low-Power $\mu$ P Supervisory Circuits with Adjustable Reset/Watchdog



Figure 9. Ensuring  $\overline{\text{RESET}}$  Valid to  $V_{CC} = 0V$

In those applications where  $\overline{\text{RESET}}$  must be valid down to 0V, adding a pull-down resistor between  $\overline{\text{RESET}}$  and ground sinks any stray leakage currents, holding  $\overline{\text{RESET}}$  low (Figure 9). The value of the pull-down resistor is not critical; 100k $\Omega$  is large enough not to load  $\overline{\text{RESET}}$  and small enough to pull  $\overline{\text{RESET}}$  to ground. For applications using the MAX6304, a 100k $\Omega$  pullup resistor between RESET and  $V_{CC}$  will hold RESET high when  $V_{CC}$  falls below 1V (Figure 10).

### Watchdog-Software Considerations

To help the watchdog timer monitor software execution more closely, set and reset the watchdog input at different points in the program, rather than pulsing the watchdog input high-low-high or low-high-low. This technique avoids a stuck loop in which the watchdog timer would continue to be reset within the loop, keeping the watchdog from timing out.

Figure 11 shows an example of a flow diagram where the I/O driving the watchdog input is set high at the beginning of the program, set low at the beginning of every subroutine or loop, then set high again when the program returns to the beginning. If the program should hang in any subroutine the problem would quickly be corrected, since the I/O is continually set low and the watchdog timer is allowed to time out, causing a reset or interrupt to be issued. When using extended mode, as described in the *Watchdog Input Current* section, this scheme does result in higher average WDI input current than does the method of leaving WDI low for the majority of the timeout period and periodically pulsing it low-high-low.

### Layout Considerations

SRT and SWT are precision current sources. When developing the layout for the application, be careful to minimize board capacitance and leakage currents around these pins. Traces connected to these pins



Figure 10. Ensuring RESET Valid to  $V_{CC} = 0V$

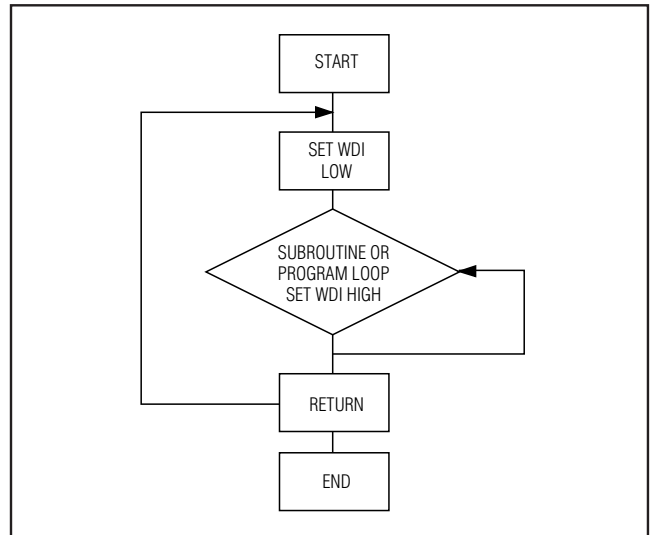

Figure 11. Watchdog Flow Diagram

should be kept as short as possible. Traces carrying high-speed digital signals and traces with large voltage potentials should be routed as far from these pins as possible. Leakage currents and stray capacitance (e.g., a scope probe) at these pins could cause errors in the reset and/or watchdog timeout period. When evaluating these parts, use clean prototype boards to ensure accurate reset and watchdog timeout periods.

RESET IN is a high-impedance input that is typically driven by a high-impedance resistor-divider network (e.g., 1M $\Omega$  to 10M $\Omega$ ). Minimize coupling to transient signals by keeping the connections to this input short. Any DC leakage current at RESET IN (e.g., a scope probe) causes errors in the programmed reset threshold. Note that sensitive pins are located on the GND side of the device, away from the digital I/O, to simplify board layout.

# +5V, Low-Power $\mu$ P Supervisory Circuits with Adjustable Reset/Watchdog

## Ordering Information (continued)

PART	TEMP RANGE	PIN-PACKAGE
<b>MAX6302</b> CPA	0°C to +70°C	8 PDIP
MAX6302CSA	0°C to +70°C	8 SO
MAX6302CUA	0°C to +70°C	8 $\mu$ MAX
MAX6302EPA	-40°C to +85°C	8 PDIP
MAX6302ESA	-40°C to +85°C	8 SO
<b>MAX6303</b> CPA	0°C to +70°C	8 PDIP
MAX6303CSA	0°C to +70°C	8 SO
MAX6303CUA	0°C to +70°C	8 $\mu$ MAX
MAX6303EPA	-40°C to +85°C	8 PDIP
MAX6303ESA	-40°C to +85°C	8 SO
<b>MAX6304</b> CPA	0°C to +70°C	8 PDIP
MAX6304CSA	0°C to +70°C	8 SO
MAX6304CUA	0°C to +70°C	8 $\mu$ MAX
MAX6304EPA	-40°C to +85°C	8 PDIP
MAX6304ESA	-40°C to +85°C	8 SO

Devices are available in both leaded and lead(Pb)-free/RoHS-compliant packaging. Specify lead-free by adding the "+" symbol at the end of the part number when ordering.

## Chip Information

PROCESS: CMOS

## Package Information

For the latest package outline information and land patterns, go to [www.maxim-ic.com/packages](http://www.maxim-ic.com/packages). Note that a "+", "#", or "-" in the package code indicates RoHS status only. Package drawings may show a different suffix character, but the drawing pertains to the package regardless of RoHS status.

PACKAGE TYPE	PACKAGE CODE	OUTLINE NO.	LAND PATTERN NO.
8 PDIP	P8-1	<a href="#">21-0043</a>	—
8 SO	S8-2	<a href="#">21-0041</a>	<a href="#">90-0096</a>
8 $\mu$ MAX	U8-1	<a href="#">21-0036</a>	<a href="#">90-0092</a>

MAX6301-MAX6304

# +5V, Low-Power $\mu$ P Supervisory Circuits with Adjustable Reset/Watchdog

## Revision History

REVISION NUMBER	REVISION DATE	DESCRIPTION	PAGES CHANGED
0	7/96	Initial release	—
1	12/05	Added lead-free notation.	1, 11
2	3/07	Updated <i>Typical Operating Circuit</i> .	1
3	3/09	Updated <i>Pin Description</i> , <i>Applications Information</i> , Figure 3, and <i>Package Information</i> .	5, 7, 11
4	9/10	Updated <i>Absolute Maximum Ratings</i> , correct part number.	2, 9, 11, 12

Maxim cannot assume responsibility for use of any circuitry other than circuitry entirely embodied in a Maxim product. No circuit patent licenses are implied. Maxim reserves the right to change the circuitry and specifications without notice at any time.

12 \_\_\_\_\_ **Maxim Integrated Products, 120 San Gabriel Drive, Sunnyvale, CA 94086 408-737-7600**

## Looking for pricing, stock, or lifecycle information?

Click below to explore more details on WIN SOURCE:

- ⊖ [View MAX6303CPA+](#) on WIN SOURCE
- ⊖ [Maxim Integrated](#) Information

## Optimize Your Supply Chain with WIN SOURCE Solutions

- ✓ Global Sourcing Solution
- ✓ Obsolete Management
- ✓ Cost Control Management
- ✓ Shortage Management
- ✓ Alternative Solution
- ✓ Excess Inventory Management