



**THE DATASHEET OF
MAX560CAI+**





+3.3V Transceiver with Two EIA/TIA-562 Receivers Active in Shutdown

MAX560/MAX561

General Description

The MAX560/MAX561 are the first +3.3V-powered devices to implement the EIA/TIA-562 standard, which guarantees interoperability with RS-232 interfaces. The MAX560/MAX561 are guaranteed to operate with a +3.0V power supply at a 20kbits/sec data rate while maintaining $\pm 3.7V$ EIA/TIA-562 signal levels.

The MAX560/MAX561 include four line drivers, five receivers, a shutdown mode, and a receiver-enable input. An on-board charge-pump voltage converter converts the +3.3V input to the $\pm 6.6V$ needed to comply with the EIA/TIA-562 output levels. The MAX560 has an active-low shutdown and an active-high receiver enable. In shutdown mode, two receivers are active, allowing unidirectional communication for peripheral monitoring. The MAX561 has an active-high shutdown and an active-low receiver enable. In shutdown mode, all receivers are in a high-impedance, three-state mode.

The MAX560/MAX561 are available in a standard 28-pin wide small outline (SO) package and a 28-pin shrink small outline package (SSOP), which requires 40% of the board space of the SO package. Each operates with four $1\mu F$ capacitors, further reducing board space.

Applications

- Laptop Computers
- Palmtop Computers
- Notebook Computers
- Battery-Powered Equipment

Features

- ◆ 2 Receivers Active In Shutdown Mode (MAX560)
- ◆ Small 28-pin SSOP Package – 40% the Area of SO Package
- ◆ Guaranteed Interoperability with RS-232
- ◆ Operate from a Single +3.0V to +3.6V Supply
- ◆ Designed for EIA/TIA-562 Applications
- ◆ 4 Drivers/5 Receivers
- ◆ Low-Power Shutdown:
 - <8 μA MAX560
 - <1 μA MAX561
- ◆ Three-State TTL/CMOS Receiver Outputs
- ◆ 116kbits/sec Data Rate

Ordering Information

PART	TEMP. RANGE	PIN-PACKAGE
MAX560CWI	0°C to +70°C	28 Wide SO
MAX560CAI	0°C to +70°C	28 SSOP
MAX560C/D	0°C to +70°C	Dice*
MAX561CWI	0°C to +70°C	28 Wide SO
MAX561CAI	0°C to +70°C	28 SSOP
MAX561C/D	0°C to +70°C	Dice*

*Dice are specified at $T_A = +25^\circ C$.

Pin Configurations

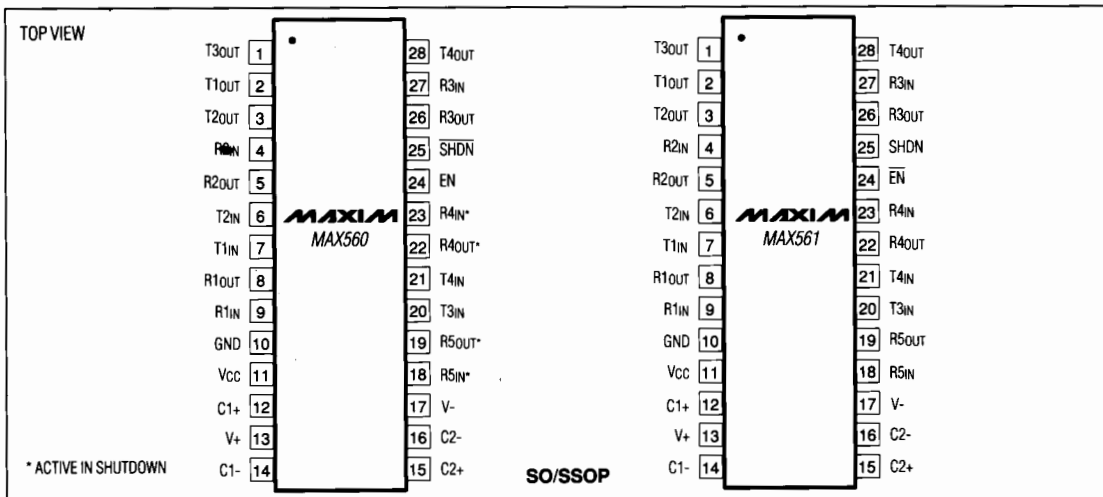

Typical operating circuit on last page



Maxim Integrated Products 1

Call toll free 1-800-998-8800 for free samples or literature.

+3.3V Transceiver with Two EIA/TIA-562 Receivers Active in Shutdown

ABSOLUTE MAXIMUM RATINGS

V _{CC}	-0.3V to +6V	Short-Circuit Duration	
V ₊	(V _{CC} - 0.3V) to +14V	T _{OUT}	Continuous
V ₋	+0.3V to -14V	Continuous Power Dissipation	
Input Voltages		Wide SO (derate 12.50mW/°C above +70°C)	1000mW
T _{IN}	0.3V to (V _{CC} + 0.3V)	SSOP (derate 9.52mW/°C above +70°C)	762mW
R _{IN}	±25V	Operating Temperature Range	0°C to +70°C
Output Voltages		Storage Temperature Range	-65°C to +160°C
T _{OUT}	(V ₊ + 0.3V) to (V ₋ - 0.3V)	Lead Temperature (soldering, 10 sec)	+300°C
R _{OUT}	-0.3V to (V _{CC} + 0.3V)		

Stresses beyond those listed under "Absolute Maximum Ratings" may cause permanent damage to the device. These are stress ratings only, and functional operation of the device at these or any other conditions beyond those indicated in the operational sections of the specifications is not implied. Exposure to absolute maximum rating conditions for extended periods may affect device reliability.

ELECTRICAL CHARACTERISTICS

(V_{CC} = +3.0V to +3.6V, C1 - C4 = 1μF, T_A = 0°C to +70°C, unless otherwise noted.)

PARAMETER	CONDITIONS		MIN	TYP	MAX	UNITS
Output Voltage Swing	3 transmitter outputs loaded with 3kΩ to ground (T1, T2, and T3)		±3.7	±4.2		V
	V _{CC} = 3.3V, 4 transmitter outputs loaded with 3kΩ to ground		±3.7	±4.5		
V _{CC} Power-Supply Current	No load, T _A = +25°C			5	8	mA
Shutdown Supply Current	Figure 1, T _A = +25°C	MAX560		8	50	μA
		MAX561		1	10	
Input Logic Threshold Low	T _{IN} , EN, $\overline{\text{SHDN}}$ (MAX560), SHDN (MAX561)				0.4	V
Input Logic Threshold High	T _{IN} , EN, $\overline{\text{SHDN}}$ (MAX560), SHDN (MAX561)		2.4			V
Logic Pull-Up Current	T _{IN} = 0V			6	135	μA
Receiver Input Voltage Operating Range			-25		25	V
EIA/TIA-562 Input Threshold Low	Normal operation		0.4	0.8		V
	$\overline{\text{SHDN}}$ = 0V, (R4 _{IN} , R5 _{IN})	MAX560	0.4	1.4		
EIA/TIA-562 Input Threshold High	Normal operation			1.1	2.4	V
	$\overline{\text{SHDN}}$ = 0V, (R4 _{IN} , R5 _{IN})	MAX560		1.4	2.4	
EIA/TIA-562 Input Hysteresis	No hysteresis when $\overline{\text{SHDN}}$ = 0V			0.3		V
EIA/TIA-562 Input Resistance	T _A = +25°C, V _{CC} = 3.3V		3	5	7	kΩ
CMOS Output Voltage Low	I _{OUT} = 1.6mA				0.4	V
CMOS Output Voltage High	I _{OUT} = -40μA		2.8	V _{CC} - 0.1		V
CMOS Output Leakage Current	EN = V _{CC} , 0V ≤ R _{OUT} ≤ V _{CC}			0.05	±10	μA
Output Enable Time	Figure 2, T _A = +25°C			800		ns
Output Disable Time				1500		ns
				500		

+3.3V Transceiver with Two EIA/TIA-562 Receivers Active in Shutdown

MAX560/MAX561

ELECTRICAL CHARACTERISTICS (continued)

(V_{CC} = 3.0V to 3.6V, C₁ - C₄ = 1μF, T_A = 0°C to +70°C, unless otherwise noted.)

PARAMETER	CONDITIONS	MIN	TYP	MAX	UNITS	
Propagation Delay	Receiver IN to Receiver OUT, C _L = 150pF	Normal operation		1.0	10	μs
		MAX560 SHDN = 0V	t _{PHLS}	4	40	
			t _{PLHS}	6	40	
Instantaneous Slew Rate	C _L = 50pF, R _L = 3kΩ to 7kΩ, T _A = +25°C (Note 1)			30	V/μs	
Transition Region Slew Rate	R _L = 3kΩ, C _L = 2500pF, Measured from +3V to -3V or -3V to +3V		2.5		V/μs	
Transmitter Output Resistance	V _{CC} = V ₊ = V ₋ = 0V, V _{OUT} = ±2V	300			Ω	
Receiver Out Short-Circuit Current			±10		mA	

Note 1: Guaranteed by design

Typical Operating Characteristics

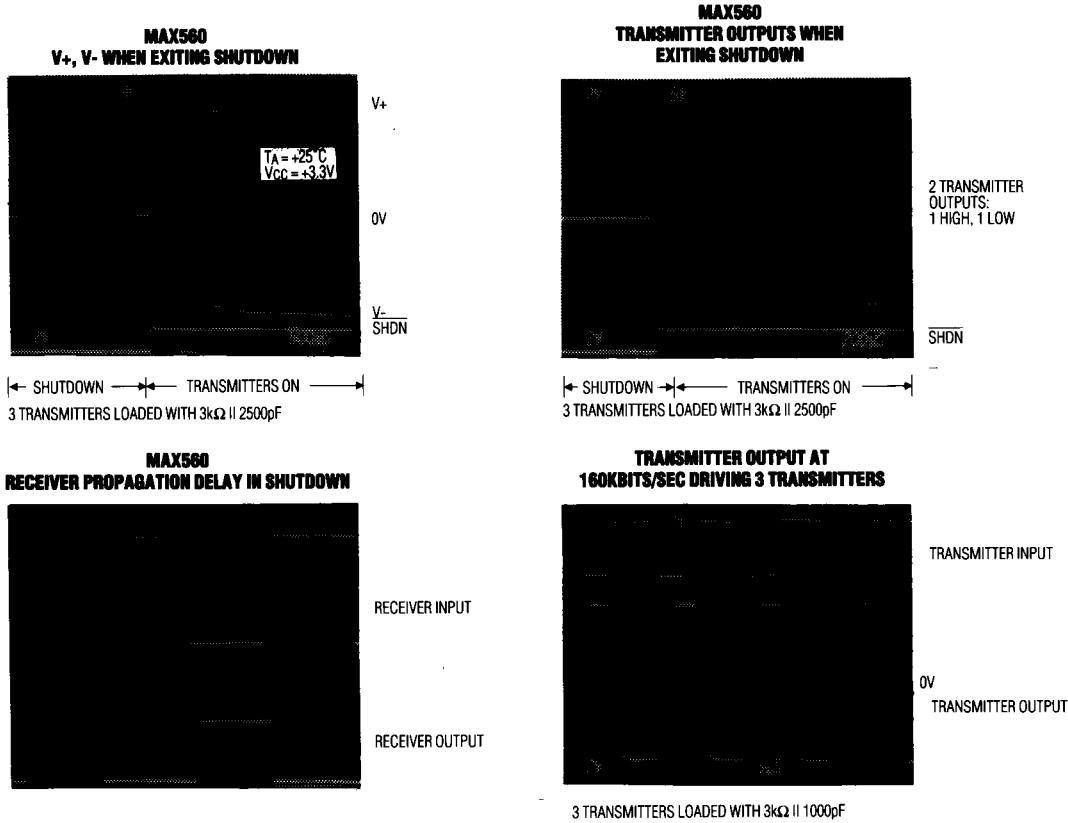

+3.3V Transceiver with Two EIA/TIA-562 Receivers Active in Shutdown

Typical Operating Characteristics (continued)

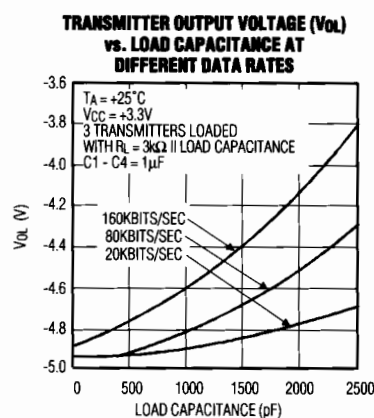
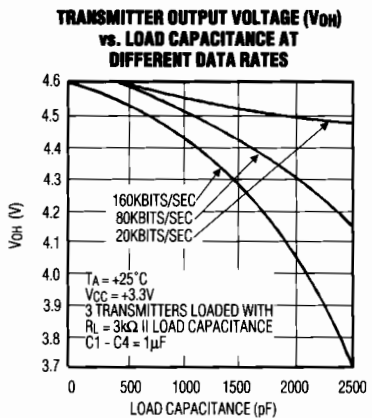
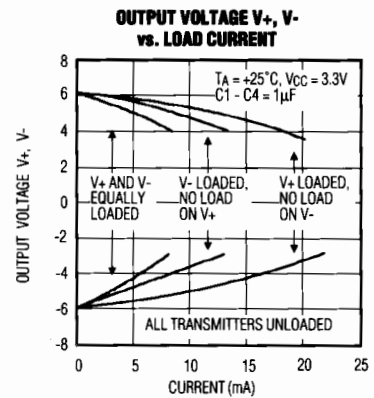
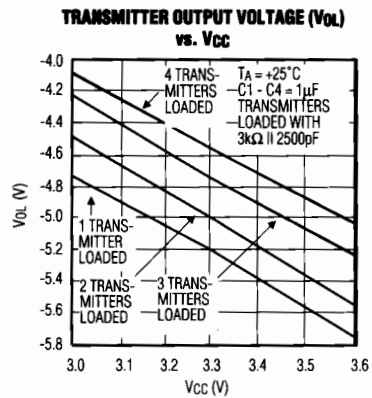
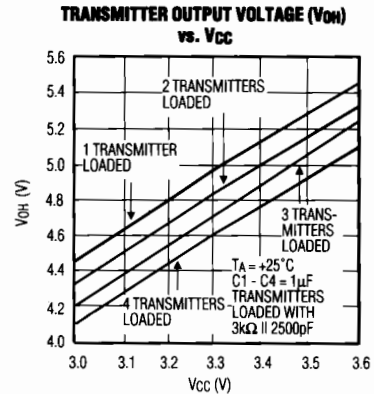
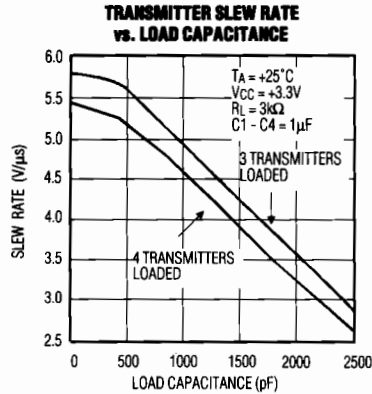

+3.3V Transceiver with Two EIA/TIA-562 Receivers Active in Shutdown

MAX560/MAX561

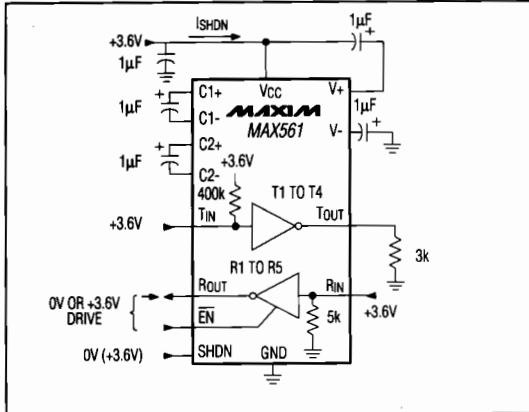

Figure 1. MAX561 Shutdown-Current Test Circuit

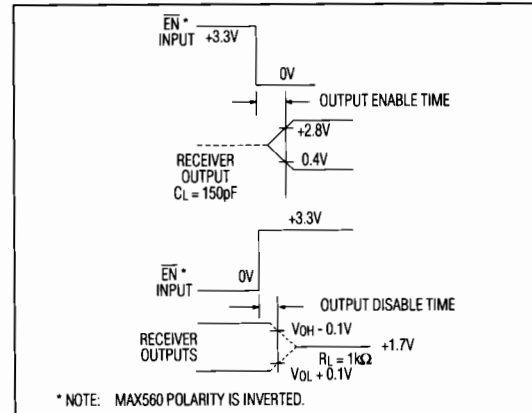

Figure 2. Receiver Output Enable and Disable Timing

Pin Description

PIN	NAME	FUNCTION		
1, 2, 3, 28	T_OUT	EIA/TIA-562 Voltage-Level Driver Outputs		
4, 9, 18, 23, 27	R_IN	EIA/TIA-562 Voltage-Level Receiver Inputs		
5, 8, 19, 22, 26	R_OUT	CMOS Receiver Outputs. When using the MAX560, receivers R4 and R5 are active in shutdown mode when EN = 1. When using the MAX561, all receivers are inactive in shutdown.		
6, 7, 20, 21	T_IN	CMOS Driver Inputs		
10	GND	Ground		
11	VCC	+3.0V to +3.6V Supply Voltage		
12, 14	C1+, C1-	Terminals for positive charge-pump capacitor		
13	V+	+2VCC Voltage generated by the charge pump		
15, 16	C2+, C2-	Terminals for negative charge-pump capacitor		
17	V-	-2VCC Voltage generated by the charge pump		
24	EN (MAX560)	Receiver Enable	Active high	See <i>Shutdown and Enable Control</i> section.
	EN (MAX561)		Active low	
25	SHDN (MAX560)	Shutdown Control	Active low	See <i>Shutdown and Enable Control</i> section.
	SHDN (MAX561)		Active high	

Detailed Description

The MAX560/MAX561 consist of three sections: charge-pump voltage converters, transmitters (drivers), and receivers. Each section is described in detail below.

+3.3V to ±6.6V Dual Charge-Pump Voltage Converter

The +3.3V to ±6.6V conversion is performed by two charge-pump voltage converters (Figure 3). The first uses capacitor C1 to double the +3.3V to +6.6V, storing the +6.6V on the V+ output filter capacitor, C3. The second charge-pump voltage converter uses capacitor C2 to

invert the +6.6V to -6.6V, storing the -6.6V on the V- output filter capacitor, C4.

In shutdown mode, V+ is internally connected to VCC by a 1kΩ pull-down resistor and V- is internally connected to ground by a 1kΩ pull-up resistor.

EIA/TIA-562 Drivers

The drivers are inverting level translators that convert +3V logic input levels to EIA/TIA-562 voltage levels. The driver outputs are inverting since the EIA/TIA-562 specification defines a receiver input voltage level greater than +3V as a 0, and a voltage level less than -3V as a 1. With

+3.3V Transceiver with Two EIA/TIA-562 Receivers Active in Shutdown

Table 1. Receiver Operation and Control

	MAX560	MAX561
Normal Operation	SHDN = 1: receivers active (EN = 1), receivers inactive (EN = 0)	SHDN = 0: receivers active ($\overline{EN} = 0$), receivers inactive (EN = 1)
Shutdown Mode	SHDN = 0: receivers R1-R3 inactive (EN = 1), receivers R4 and R5 active (EN = 1), receivers R1-R5 inactive (EN = 0)	SHDN = 1: receivers inactive ($\overline{EN} = 0$), receivers inactive (EN = 1)

VCC = +3.0V, the typical output voltage swing is 4.1V when driving three transmitters, each with the worst-case 3kΩ load. Under such conditions, the output swing is guaranteed to meet the EIA/TIA-562 minimum specification of 3.7V output voltage swing. The open-circuit output voltage swings from (V+ - 0.6V) to V-.

The inputs of unused driver sections should be connected to VCC, but can be left unconnected; an internal 400kΩ input pull-up resistor to VCC will pull the inputs high, forcing unused transmitter outputs low. The input pull-up resistors typically source 6μA; therefore, the driver inputs should be driven high or open circuited to minimize power-supply current in shutdown mode.

When in the low-power shutdown mode, the driver outputs are turned off and their leakage current is less than 1μA with the driver output pulled to ground. The driver output leakage remains less than 1μA, even if the transmitter output is backdriven between 0V and (VCC + 6V). Below -0.5V, the transmitter input is diode clamped to ground with a 1kΩ series impedance. The transmitter input is also zener clamped to approximately (VCC + 6V), with a 1kΩ series impedance.

EIA/TIA-562 Receivers

The receivers convert ±3.7V to ±13.2V EIA/TIA-562 level signals to +3V logic output levels. The receiver outputs are inverting, maintaining compatibility with the driver outputs. Maxim has set guaranteed receiver input thresholds of 0.4V and 2.4V, which are significantly tighter than the ±3.0V thresholds required by the EIA/TIA-562

specification. This allows the receivers to respond to +3V logic levels as well as EIA/TIA-562 levels.

The MAX560/MAX561's guaranteed 0.4V lower threshold ensures that a receiver shorted to ground will have a logic 1 output. The 5kΩ input resistance to ground ensures that a receiver with its input left open will also have a logic 1 output.

The receivers have approximately 0.3V hysteresis. This provides clean output transitions, even with slow rise and fall time input signals with moderate amounts of noise and ringing. In shutdown, the MAX560 receivers R4 and R5 have no hysteresis.

Shutdown and Enable Control

THE POLARITY OF THE RECEIVER ENABLE AND SHUTDOWN LOGIC LEVELS FOR THE MAX560 ARE THE INVERSE OF THOSE FOR THE MAX561.

Table 1 shows the polarity of the shutdown and enable controls for the MAX560/MAX561.

In shutdown mode, the MAX560/MAX561 charge pump is turned off, V+ is pulled down to VCC, and V- is pulled to ground. Also, the receiver outputs are put into a high-impedance state (R4 and R5 status depend on the EN pin if using the MAX560) and the transmitter outputs are disabled. This drops the supply current to approximately 8μA for the MAX560 and 1μA for the MAX561. The time required to exit shutdown is typically 1ms, as shown in the *Typical Operating Characteristics* graphs.

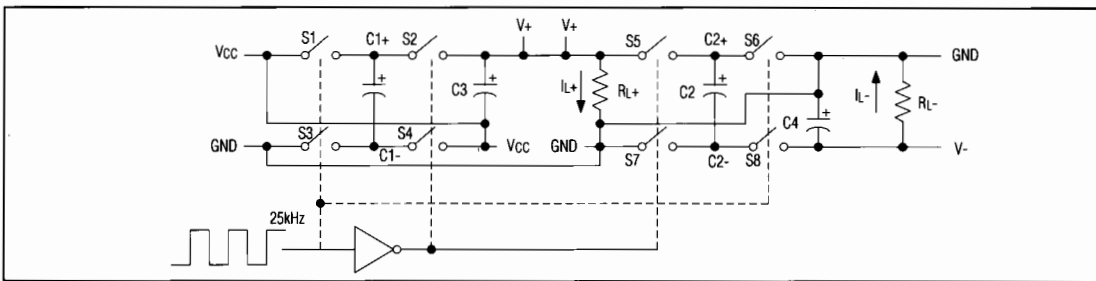

Figure 3. Charge Pump

+3.3V Transceiver with Two EIA/TIA-562 Receivers Active in Shutdown

MAX560/MAX561

Applications Information

Capacitor Selection

The type of capacitor used is not critical for proper MAX560/MAX561 operation. Aluminum electrolytic, ceramic, or tantalum capacitors are suggested. To ensure proper EIA/TIA-562 signal levels over temperature when using 1 μ F capacitors, make sure the capacitance value does not degrade excessively as the temperature varies. If in doubt, use capacitors with a larger nominal value. Also observe the effective series resistance (ESR) value of the capacitors over temperature, since it will influence the amount of ripple on V+ and V-. To reduce the output impedance at V+ and V-, larger capacitors (up to 10 μ F) can be used.

Driving Multiple Receivers

Each transmitter is designed to drive a single receiver. Transmitters can be paralleled to drive multiple receivers.

Transmitter Outputs when Exiting Shutdown

The *Typical Operating Characteristics* section shows the reaction of the MAX560 transmitter outputs when exiting shutdown. Two transmitter outputs are shown going to opposite RS-232 levels as they become active (one transmitter is high, the other low). Each transmitter is loaded with 3k Ω in parallel with 2500pF. The transmitter outputs display no ringing or undesirable transients as they come out of shutdown.

MAX560 Receiver Operation in Shutdown

During normal operation, the MAX560's receiver propagation delay is typically 1 μ s. When entering shutdown with the receiver active, the receiver outputs R4 and R5 are not valid until 80 μ s after SHDN is driven low. In shutdown mode, propagation delay increases to a

typical 4 μ s for a high to low transition and 6 μ s for a low to high transition ($V_{CC} = +3.3V$), as shown in the Receiver Propagation Delay in Shutdown graph in the *Typical Operating Characteristics*. Irrespective of EN, receiver outputs R1, R2, and R3 are inactive in shutdown. When exiting shutdown, all receiver outputs are invalid until the charge pumps reach nominal levels (500 μ s when using 1 μ F capacitors).

Power-Supply Decoupling

In applications that are sensitive to power-supply noise, decouple VCC to ground with a capacitor of the same value as the charge-pump capacitors.

V+ and V- as Power Supplies

A small amount of power can be drawn from V+ and V-, although this will reduce transmitter noise margins. See the Output Voltage vs. Load Current graph in the *Typical Operating Characteristics* section.

High Data Rates

The MAX560/MAX561 maintain the EIA/TIA-562 $\pm 3.7V$ minimum transmitter output voltage even at high data rates. The *Typical Operating Characteristics* show a transmitter output at 160kbits/sec.

EIA/TIA Standards

Before the MAX232 was invented, many "quasi" RS-232 interfaces were implemented with $\pm 5.0V$ power supplies. Output levels from the transmitters often failed to meet the RS-232 specifications, but the interfaces were functional over short distances, often at data rates above 20kbits/sec, due to the RS-232's 2V margin between its $\pm 5V$ minimum transmitter output specification and the $\pm 3V$ receiver input specification. The advent of +3V-powered systems led to the creation of the EIA/TIA-562 specification. Table 2 summarizes both specifications.

Table 2. Summary of EIA/TIA-232E/V.28 and EIA/TIA-562 Specifications

PARAMETER	CONDITION	EIA/TIA-232E/V.28 SPECIFICATION	EIA/TIA-562 SPECIFICATION
Driver Output Voltage 0 Level 1 Level	3k Ω to 7k Ω Load	5.0V to 15.0V	3.7V to 13.2V
		-5.0V to -15.0V	-3.7V to -13.2V
Maximum Output Level	No load	$\pm 25V$	$\pm 13.2V$
Signal Rate (3k $\Omega \leq R_L \leq 7k\Omega$)	C _L = 2500pF	Up to 20kbits/sec	Up to 20kbits/sec
	C _L = 1000pF	Not defined	Up to 64kbits/sec

+3.3V Transceiver with Two EIA/TIA-562 Receivers Active in Shutdown

Table 2. Summary of EIA/TIA-232E/V.28 and EIA/TIA-562 Specifications (continued)

PARAMETER	CONDITION	EIA/TIA-232E/V.28 SPECIFICATION	EIA/TIA-562 SPECIFICATION
Receiver Input Thresholds			
0 Level		3.0V to 15.0V	3.0V to 15.0V
1 Level		-3.0V to -15.0V	-3.0V to -15.0V
Maximum Input Level		±25V	±25V
Maximum Instantaneous Slew Rate		30V/μs	30V/μs
Maximum Driver Output Short-Circuit Current		100mA	60mA
Transition Rate on Driver Output		V.28 1ms or 3% of the period RS-232 4% of the period	4V/μs
Driver Output Resistance with Power Off	-2V < V _{OUT} < 2V	300Ω	300Ω

Typical Operating Circuit

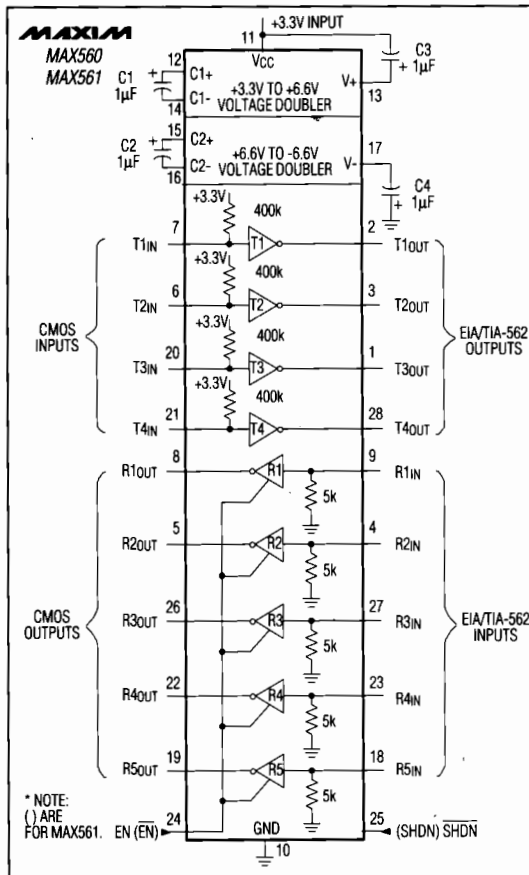

Package Information

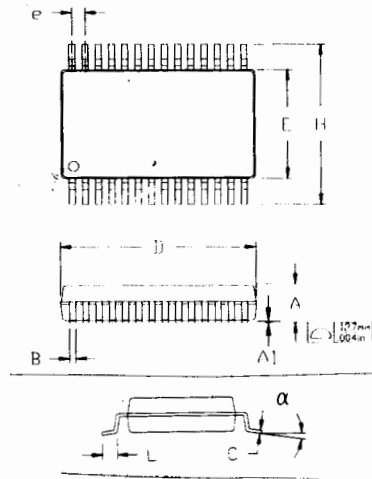

DIM	INCHES		MILLIMETERS	
	MIN	MAX	MIN	MAX
A	0.068	0.078	1.73	1.99
A1	0.002	0.008	0.05	0.21
B	0.010	0.015	0.25	0.38
C	0.005	0.009	0.13	0.22
D	0.397	0.407	10.07	10.33
e	0.0256	BSC	0.65	BSC
E	0.205	0.212	5.20	5.38
H	0.301	0.311	7.65	7.9
L	0.022	0.037	0.55	0.95
α	0°	8°	0°	8°

Maxim cannot assume responsibility for use of any circuitry other than circuitry entirely embodied in a Maxim product. No circuit patent licenses are implied. Maxim reserves the right to change the circuitry and specifications without notice at any time.

Maxim Integrated Products, 120 San Gabriel Drive, Sunnyvale, CA 94086 (408) 737-7600

Looking for pricing, stock, or lifecycle information?

Click below to explore more details on WIN SOURCE:

- ⊖ [View MAX560CAI+ on WIN SOURCE](#)
- ⊖ [Maxim Integrated Information](#)

Optimize Your Supply Chain with WIN SOURCE Solutions

- ✓ Global Sourcing Solution
- ✓ Obsolete Management
- ✓ Cost Control Management
- ✓ Shortage Management
- ✓ Alternative Solution
- ✓ Excess Inventory Management