



**THE DATASHEET OF  
MAX5457EEE+T**



# MAX5456/MAX5457

## Stereo Audio Taper Potentiometers with Pushbutton Interface

### General Description

The MAX5456/MAX5457 dual, logarithmic taper digital potentiometers feature a simple pushbutton interface that controls volume and balance in audio applications. Each potentiometer has 32 tap points and replaces mechanical potentiometers. Refer to the MAX5408–MAX5411 data sheet for SPI versions of the MAX5456/MAX5457.

Use the MAX5456/MAX5457 digital inputs with momentary contact single-pole/single-throw (SPST) pushbutton switches. Each input includes internal debounce circuitry and a 50kΩ pullup resistor.

The MAX5456/MAX5457 advance the wiper setting once per button push. Maxim's proprietary SmartWiper™ control eliminates the need for a microcomputer to increase the wiper transition rate. Holding the control input low for more than 1s advances the wiper at a rate of 4Hz for 4s and 16Hz per second thereafter.

The MAX5456/MAX5457 provide temperature coefficients of 50ppm/°C end-to-end and 5ppm/°C ratiometric and a nominal resistance of 10kΩ per potentiometer. An integrated click/pop suppression feature minimizes the audible noise generated by wiper transitions. The typical total harmonic distortion plus noise (THD+N) for these devices is 0.01%.

The MAX5457 features a 3-button interface with a MODE input that toggles between volume- and balance-control modes. An LED output indicates volume or balance mode. The MAX5456 features a 4-button interface with separate inputs for up and down volume controls and left and right balance controls.

The MAX5456/MAX5457 is available in a 16-pin QSOP packages and specified over the extended (-40°C to +85°C) temperature range.

### Applications

- Stereo Volume Control
- Fading and Balancing Stereo Signals
- Stereo Blending and Mixing

**Typical Application Circuits and Selector Guide appear at end of data sheet.**

*SmartWiper is a trademark of Maxim Integrated Products, Inc.*

### Features

- ◆ SmartWiper Control Provides Accelerated Wiper Motion
- ◆ Debounced Pushbutton Interface with Internal Pullup Resistors
- ◆ Logarithmic Taper with 2dB Steps Between Taps
- ◆ Single +2.7V to +5.5V or Dual ±2.7V Supply Operation
- ◆ Low 0.5μA Standby Supply Current
- ◆ Clickless Switching
- ◆ 10kΩ End-to-End Fixed Resistance Value
- ◆ Mute Function to -90dB (typ)
- ◆ Power-On Reset to -12dB Wiper Position
- ◆ 32 Tap Positions for Each Wiper
- ◆ Small 16-Pin QSOP Package

### Ordering Information

| PART        | TEMP RANGE     | PIN-PACKAGE |
|-------------|----------------|-------------|
| MAX5456EEE+ | -40°C to +85°C | 16 QSOP     |
| MAX5457EEE+ | -40°C to +85°C | 16 QSOP     |

+Denotes a lead(Pb)-free/RoHS-compliant package.

Note: For leaded version, contact factory.

### Pin Configurations

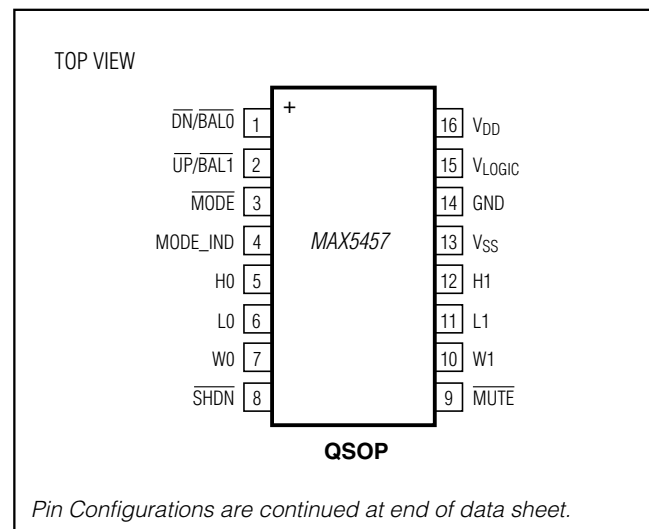

# MAX5456/MAX5457

## Stereo Audio Taper Potentiometers with Pushbutton Interface

### ABSOLUTE MAXIMUM RATINGS

|   |                                      |
|---|--------------------------------------|
| (MAX5456) SHDN, MUTE, VOLUP, VOLDN,<br>BAL_ to GND.....               | -0.3V to (V <sub>LOGIC</sub> + 0.3V) |
| (MAX5457) SHDN, MUTE, UP/BAL1, DN/BAL0, MODE,<br>MODE_IND to GND..... | -0.3V to (V <sub>LOGIC</sub> + 0.3V) |
| H_, L_, and W_ to V <sub>SS</sub> .....                               | -0.3V to (V <sub>DD</sub> + 0.3 V)   |
| V <sub>DD</sub> to GND.....   | -0.3V to +6V                         |
| V <sub>DD</sub> to V <sub>SS</sub> .....                              | -0.3V to +6V                         |
| V <sub>LOGIC</sub> to GND.....  | -0.3V to +6V                         |
| V <sub>LOGIC</sub> to V <sub>SS</sub> .....                           | -0.3V to +6V                         |
| V <sub>SS</sub> to GND.....   | -3.0V to +0.3V                       |

|   |                 |
|---|-----------------|
| Peak Current into H_, L_, and W_.....   | ±1mA            |
| Average Current into H_, L_, and W_.....  | ±500µA          |
| Input and Output Latchup Immunity.....  | ±200mA          |
| Continuous Power Dissipation (T <sub>A</sub> = +70°C)<br>16-Pin QSOP (derate 8.3mW/°C above +70°C)..... | 666.7mW         |
| Operating Temperature Range .....   | -40°C to +85°C  |
| Junction Temperature .....  | +150°C          |
| Storage Temperature Range .....   | -60°C to +150°C |
| Lead Temperature (soldering, 10s).....  | +300°C          |
| Soldering Temperature (reflow).....   | +260°C          |

Stresses beyond those listed under "Absolute Maximum Ratings" may cause permanent damage to the device. These are stress ratings only, and functional operation of the device at these or any other conditions beyond those indicated in the operational sections of the specifications is not implied. Exposure to absolute maximum rating conditions for extended periods may affect device reliability.

### ELECTRICAL CHARACTERISTICS

(V<sub>DD</sub> = V<sub>LOGIC</sub> = +2.7V to +5.5V, V<sub>SS</sub> = 0V, GND = 0V, V<sub>H</sub> = V<sub>DD</sub>, V<sub>L</sub> = V<sub>SS</sub>, T<sub>A</sub> = T<sub>MIN</sub> to T<sub>MAX</sub>. Typical values are at T<sub>A</sub> = +25°C, unless otherwise specified.) (Note 1)

| PARAMETER   | SYMBOL              | CONDITIONS  | MIN | TYP   | MAX  | UNITS             |
|---|---------------------|---|-----|-------|------|-------------------|
| End-to-End Resistance   | R                   | Figures 1, 2  | 7   | 10    | 13   | kΩ                |
| Maximum Bandwidth   | f <sub>CUTOFF</sub> | From H_ to W_, C <sub>LOAD</sub> = 10pF   |     | 100   |      | kHz               |
| Absolute Ratio Tolerance  |                     | No load at the output of the wiper, W_ = -6dB   |     | ±0.25 |      | dB                |
| Tap-to-Tap Tolerance  |                     |   |     | ±0.1  |      | dB                |
| Total Harmonic Distortion Plus Noise  | THD+N               | V <sub>DD</sub> = 5V, V <sub>H</sub> = (V <sub>DD</sub> / 2) + 1V <sub>RMS</sub> ,<br>f = 1kHz, tap = -6dB, V <sub>L</sub> = V <sub>DD</sub> / 2, R <sub>L</sub> = ∞  |     | 0.01  |      | %                 |
|   |                     | V <sub>DD</sub> = 3V, V <sub>SS</sub> = 0V, V <sub>L</sub> = 1.5V,<br>V <sub>H</sub> = 1.5V + 1V <sub>RMS</sub> , f = 1kHz, R <sub>L</sub> = 10kΩ to<br>(V <sub>DD</sub> / 2), C <sub>L</sub> = 5pF, tap = -6dB |     | 0.23  |      |                   |
| Channel-to-Channel Isolation  |                     |   |     | -100  |      | dB                |
| Interchannel Matching   |                     | f = 20Hz to 20kHz, tap = -6dB   |     | ±0.5  |      | dB                |
| Mute Attenuation  |                     |   |     | -90   |      | dB                |
| Power-Supply Rejection Ratio  | PSRR                |   |     | -80   |      | dB                |
| Wiper Resistance  | R <sub>W</sub>      |   |     | 1000  | 1700 | Ω                 |
| Wiper Capacitance   | C <sub>W</sub>      |   |     | 10    |      | pF                |
| H Terminal Capacitance  | C <sub>H</sub>      |   |     | 5     |      | pF                |
| L Terminal Capacitance  | C <sub>L</sub>      |   |     | 7     |      | pF                |
| End-to-End Resistance Temperature Coefficient   |                     |   |     | 50    |      | ppm/°C            |
| Ratiometric Resistance Temperature Coefficient  |                     |   |     | 5     |      | ppm/°C            |
| Output Noise  | e <sub>n</sub>      | 20Hz to 20kHz   |     | 0.95  |      | µV <sub>RMS</sub> |
| <b>PUSHBUTTON CONTACT INPUTS (UP/BAL1, DN/BAL0, MUTE, VOLUP, VOLDN, BAL0, BAL1, MODE)</b> |                     |   |     |       |      |                   |
| Internal Pullup Resistor  | R <sub>PULLUP</sub> |   | 32  | 50    | 65   | kΩ                |
| Single Pulse-Width Input  | t <sub>IPW</sub>    | Figure 5  |     | 22.5  |      | ms                |
| Repetitive Input Pulse High Time  | t <sub>HPW</sub>    | Figure 5  |     | 40    |      | ms                |
| Timeout Period  | t <sub>WS</sub>     | Click/pop suppression inactive  |     | 32    |      | ms                |

# MAX5456/MAX5457

## Stereo Audio Taper Potentiometers with Pushbutton Interface

### ELECTRICAL CHARACTERISTICS (continued)

( $V_{DD} = V_{LOGIC} = +2.7V$  to  $+5.5V$ ,  $V_{SS} = 0V$ ,  $GND = 0V$ ,  $V_{HL} = V_{DD}$ ,  $V_{L-} = V_{SS}$ ,  $T_A = T_{MIN}$  to  $T_{MAX}$ . Typical values are at  $T_A = +25^{\circ}C$ , unless otherwise specified.) (Note 1)

| PARAMETER  | SYMBOL          | CONDITIONS   | MIN                    | TYP | MAX                    | UNITS   |
|--|-----------------|--|------------------------|-----|------------------------|---------|
| First Autoincrement Point                                |                 |  |                        | 1   |                        | s       |
| First Autoincrement Rate                                 |                 |  |                        | 4   |                        | Hz      |
| Second Autoincrement Point                               |                 |  |                        | 4   |                        | s       |
| Second Autoincrement Rate                                |                 |  |                        | 16  |                        | Hz      |
| <b>DIGITAL INPUTS (<math>V_{LOGIC} &gt; 4.5V</math>)</b> |                 |  |                        |     |                        |         |
| Input High Voltage                                       | $V_{IH}$        |  | 2.4                    |     |                        | V       |
| Input Low Voltage  | $V_{IL}$        |  |                        |     | 0.8                    | V       |
| Input Leakage Current                                    |                 | Inputs floating  |                        |     | $\pm 1$                | $\mu A$ |
| Input Capacitance  |                 |  |                        | 5   |                        | pF      |
| <b>DIGITAL INPUTS (<math>V_{LOGIC} &lt; 4.5V</math>)</b> |                 |  |                        |     |                        |         |
| Input High Voltage                                       | $V_{IH}$        |  | $0.7 \times V_{LOGIC}$ |     |                        | V       |
| Input Low Voltage  | $V_{IL}$        |  |                        |     | $0.3 \times V_{LOGIC}$ | V       |
| Input Leakage Current                                    |                 | Inputs floating  |                        |     | $\pm 1$                | $\mu A$ |
| Input Capacitance  |                 |  |                        | 5   |                        | pF      |
| <b>POWER SUPPLIES</b>                                    |                 |  |                        |     |                        |         |
| Supply Voltage   | $V_{DD}$        |  | 2.7                    |     | 5.5                    | V       |
| Negative Power Supply                                    | $V_{SS}$        |  | -2.7                   |     | 0                      | V       |
| Supply-Voltage Difference                                |                 | $V_{DD} - V_{SS}$  |                        |     | 5.5                    | V       |
| Active Supply Current                                    | $I_{DD}$        | (Note 2)   |                        |     | 100                    | $\mu A$ |
| Standby Supply Current                                   | $I_{STBY}$      | $V_{DD} = +5.5V$ , $V_{SS} = 0V$ , $V_{LOGIC} = 2.7V$ (Note 3) |                        | 2   | 10                     | $\mu A$ |
|  |                 | $V_{LOGIC} = V_{DD} = +2.7V$ , $V_{SS} = -2.7V$ (Note 3)       |                        | 0.5 | 1                      |         |
| Shutdown Supply Current                                  | $I_{SHDN}$      | (Note 4)   |                        |     | 1                      | $\mu A$ |
| Power-Up Time  | $t_{PU}$        |  |                        | 10  |                        | ms      |
| Logic Standby Voltage                                    | $V_{LOGIC}$     |  | 2.7                    |     | $V_{DD}$               | V       |
| Logic Active Supply Current                              | $I_{LOGIC}$     | (Note 2)   |                        |     | 160                    | $\mu A$ |
| Logic Standby Supply Current                             | $I_{LOGICSTBY}$ | (Note 3)   |                        | 0.5 | 1                      | $\mu A$ |
| Logic Shutdown Current                                   | $I_{LOGICSHDN}$ | (Note 4)   |                        |     | 1                      | $\mu A$ |
| <b>DIGITAL OUTPUT, MODE_IND</b>                          |                 |  |                        |     |                        |         |
| Output Low Voltage                                       | $V_{OL}$        | $V_{LOGIC} = 2.7V$ , $I_{SINK} = 10mA$                         |                        |     | 0.4                    | V       |
|  |                 | $V_{LOGIC} = 5.5V$ , $I_{SINK} = 10mA$                         |                        |     | 0.2                    |         |
| Output Leakage Current                                   |                 |  |                        | 0.1 | 10                     | $\mu A$ |
| Output Capacitance                                       |                 |  |                        | 3   |                        | pF      |
| Maximum Sink Current                                     |                 |  |                        | 150 |                        | mA      |

**Note 1:** Parameters are 100% production tested at  $+85^{\circ}C$  and limits through temperature are guaranteed by design.

**Note 2:** Supply current measured with the supply on and a button pushed.

**Note 3:** Supply current measured with the power on, no button pushed, and the wiper position fixed.

**Note 4:** This is the measured current with  $\overline{SHDN}$  low and  $MODE\_IND$  unconnected.

# MAX5456/MAX5457

## Stereo Audio Taper Potentiometers with Pushbutton Interface

### Typical Operating Characteristics

( $V_{DD} = V_{LOGIC} = +2.7V$  to  $+5.5V$ ,  $V_{SS} = 0V$ ,  $GND = 0V$ ,  $V_{H-} = V_{DD}$ ,  $V_{L-} = V_{SS}$ ,  $T_A = T_{MIN}$  to  $T_{MAX}$ . Typical values are at  $T_A = +25^\circ C$ , unless otherwise specified.)

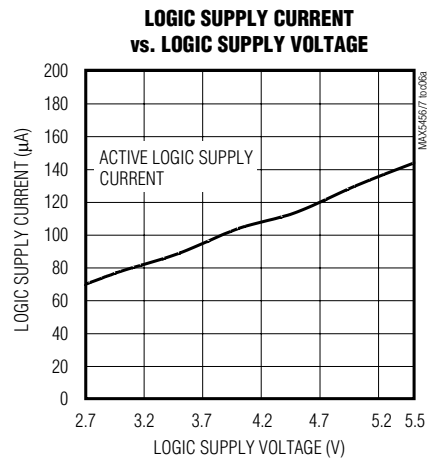
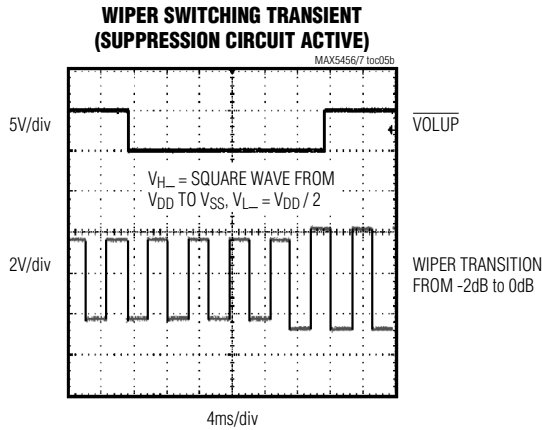
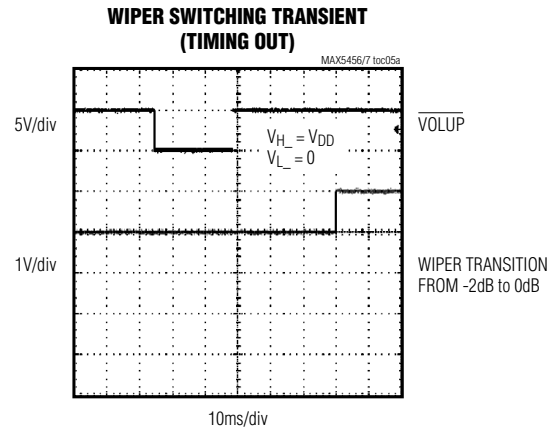
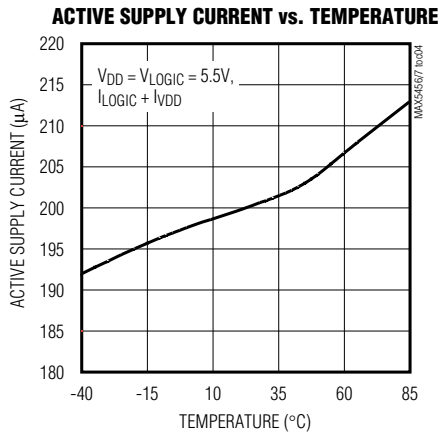
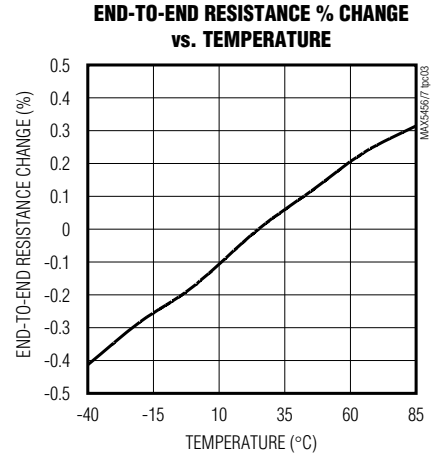
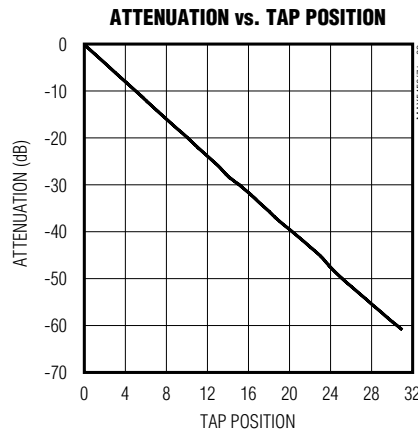
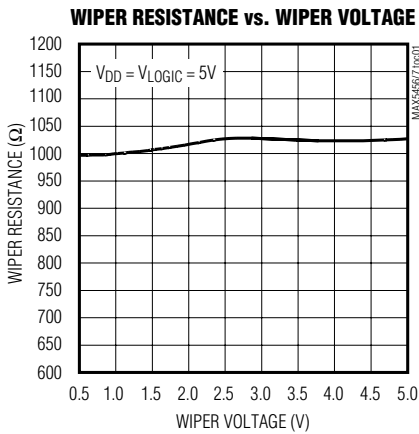

# MAX5456/MAX5457

## Stereo Audio Taper Potentiometers with Pushbutton Interface

### Typical Operating Characteristics (continued)

( $V_{DD} = V_{LOGIC} = +2.7V$  to  $+5.5V$ ,  $V_{SS} = 0V$ ,  $GND = 0V$ ,  $V_{H-} = V_{DD}$ ,  $V_{L-} = V_{SS}$ ,  $T_A = T_{MIN}$  to  $T_{MAX}$ . Typical values are at  $T_A = +25^\circ C$ , unless otherwise specified.)

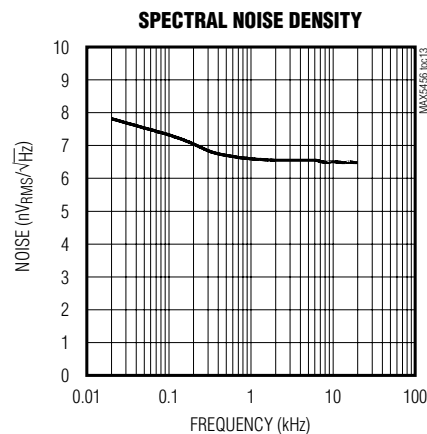
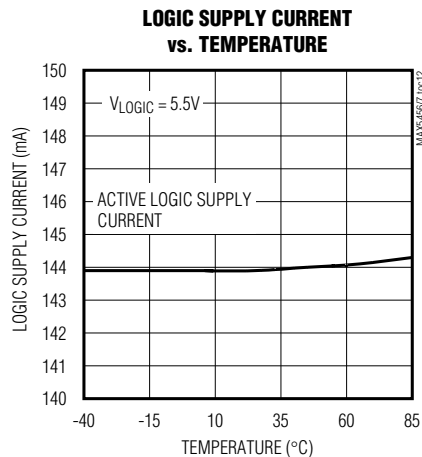
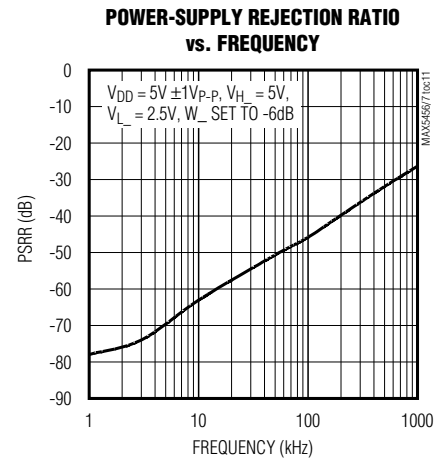
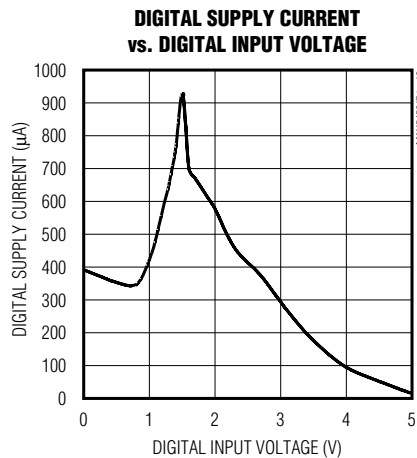
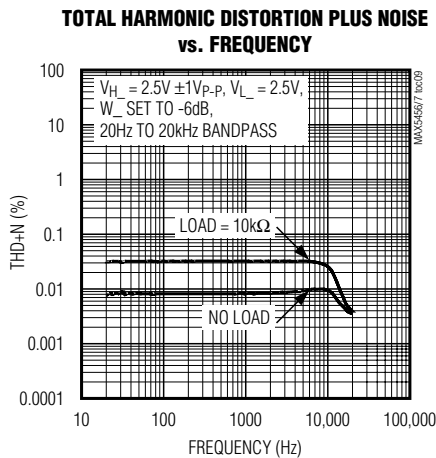
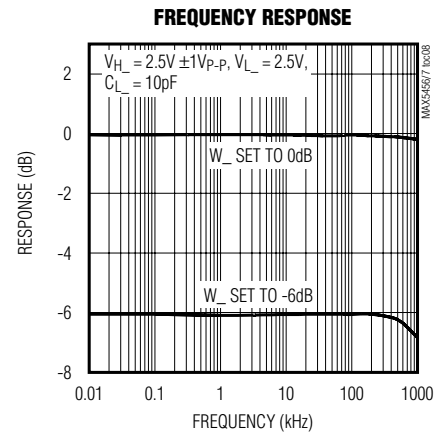
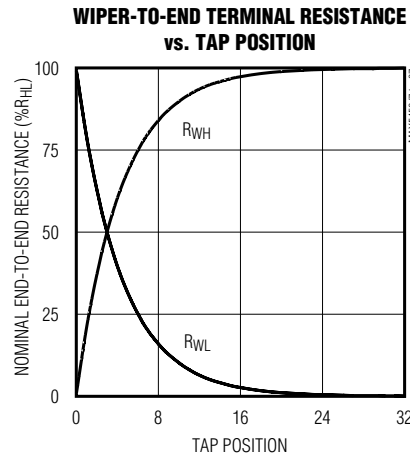
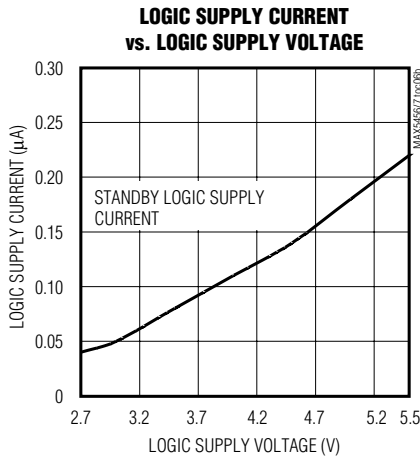

# MAX5456/MAX5457

## Stereo Audio Taper Potentiometers with Pushbutton Interface

### Pin Description

| PIN     |         | NAME                        | FUNCTION  |
|---------|---------|-----------------------------|---|
| MAX5457 | MAX5456 |                             |   |
| 3       | —       | $\overline{\text{MODE}}$    | Volume/Balance Control. Each transition from high to low toggles between volume and balance modes. $\overline{\text{MODE}}$ is pulled high internally with a 50k $\Omega$ resistor to $V_{\text{LOGIC}}$ . On power-up, the MAX5457 is in volume-control mode.  |
| 4       | —       | MODE_IND                    | Volume-Control/Balance-Control Mode Indicator Open-Drain Output. Connect to an LED through a resistor to $V_{\text{LOGIC}}$ . When the LED is on, the MAX5457 is in balance-control mode. When the LED is off, the MAX5457 is in volume-control mode. See the <i>Mode Indicator, MODE_IND</i> section for more detail.                    |
| 5       | 5       | H0                          | Potentiometer 0 High Terminal. H0 and L0 terminals can be reversed.   |
| 6       | 6       | L0                          | Potentiometer 0 Low Terminal. L0 and H0 terminals can be reversed.  |
| 7       | 7       | W0                          | Potentiometer 0 Wiper Terminal  |
| 8       | 8       | $\overline{\text{SHDN}}$    | Active-Low Shutdown Input. In shutdown mode, the MAX5456/MAX5457 store the last wiper settings. The wipers move to the L end of the resistor string, and the H end of the resistor string disconnects from the signal input. Terminating shutdown mode restores the wipers to their previous settings.                                    |
| 9       | 9       | $\overline{\text{MUTE}}$    | Mute Input. When $\overline{\text{MUTE}}$ is low, the wiper goes to the highest attenuation setting (see Table 1). $\overline{\text{MUTE}}$ is internally pulled up with 50k $\Omega$ to $V_{\text{LOGIC}}$ .   |
| 10      | 10      | W1                          | Potentiometer 1 Wiper Terminal  |
| 11      | 11      | L1                          | Potentiometer 1 Low Terminal. L1 and H1 terminals can be reversed.  |
| 12      | 12      | H1                          | Potentiometer 1 High Terminal. H1 and L1 terminals can be reversed.   |
| 13      | 13      | VSS                         | Negative Power Supply. Bypass with 0.1 $\mu\text{F}$ to ground.   |
| 14      | 14      | GND                         | Ground  |
| 15      | 15      | $V_{\text{LOGIC}}$          | Digital Logic Power Supply. Bypass with 0.1 $\mu\text{F}$ to ground.  |
| 16      | 16      | VDD                         | Analog Power Supply. Bypass with 0.1 $\mu\text{F}$ to ground.   |
| 1       | —       | $\overline{\text{DN/BAL0}}$ | Downward Volume/Channel 0 Balance-Control Input. In volume mode, pressing $\overline{\text{DN/BAL0}}$ moves both wipers towards the L terminals. In balance mode, pressing $\overline{\text{DN/BAL0}}$ moves the balance towards channel 0. $\overline{\text{DN/BAL0}}$ is internally pulled up with 50k $\Omega$ to $V_{\text{LOGIC}}$ . |
| 2       | —       | $\overline{\text{UP/BAL1}}$ | Upward Volume/Channel 1 Balance-Control Input. In volume mode, pressing $\overline{\text{UP/BAL1}}$ moves both wipers towards the H terminals. In balance mode, pressing $\overline{\text{UP/BAL1}}$ moves the balance towards channel 1. $\overline{\text{UP/BAL1}}$ is internally pulled up with 50k $\Omega$ to $V_{\text{LOGIC}}$ .   |
| —       | 3       | $\overline{\text{BAL1}}$    | Channel 1 Balance-Control Input. Pressing $\overline{\text{BAL1}}$ moves the balance towards channel 1. $\overline{\text{BAL1}}$ is internally pulled up with 50k $\Omega$ to $V_{\text{LOGIC}}$ .  |
| —       | 4       | $\overline{\text{BAL0}}$    | Channel 0 Balance-Control Input. Pressing $\overline{\text{BAL0}}$ moves the balance towards channel 0. $\overline{\text{BAL0}}$ is internally pulled up with 50k $\Omega$ to $V_{\text{LOGIC}}$ .  |
| —       | 1       | $\overline{\text{VOLDN}}$   | Downward Volume-Control Input. Pressing $\overline{\text{VOLDN}}$ moves both wipers towards the L terminals. $\overline{\text{VOLDN}}$ is internally pulled up with 50k $\Omega$ to $V_{\text{LOGIC}}$ .  |
| —       | 2       | $\overline{\text{VOLUP}}$   | Upward Volume-Control Input. Pressing $\overline{\text{VOLUP}}$ moves both wipers towards the H terminals. $\overline{\text{VOLUP}}$ is internally pulled up with 50k $\Omega$ to $V_{\text{LOGIC}}$ .  |

# MAX5456/MAX5457

## Stereo Audio Taper Potentiometers with Pushbutton Interface

### Detailed Description

The MAX5456/MAX5457 dual, logarithmic taper digital potentiometers feature a simple pushbutton interface that controls volume and balance in audio applications. Each potentiometer has 32 tap points and replaces mechanical potentiometers (see the *Functional Diagrams*).

### Up and Down Interface

The MAX5456/MAX5457 interface with momentary contact SPST switches. All switch inputs are internally debounced and pulled up to  $V_{\text{LOGIC}}$  through  $50\text{k}\Omega$  resistors. The wiper setting advances once per button press up to 1s. Maxim's SmartWiper control circuitry allows the wiper to advance at a rate of 4Hz when an input is held low from 1s up to 4s, and at a rate of 16Hz if the contact is maintained for greater than 4s (see Table 2). The SmartWiper control eliminates the need for a microcomputer to increase the wiper transition rate.

The MAX5456 features independent control inputs for volume and balance control while the MAX5457  $\overline{\text{MODE}}$  input toggles between volume and balance control. Each transition of  $\overline{\text{MODE}}$  from high to low toggles the MAX5457 between volume-control and balance-control modes.  $\overline{\text{MODE}}$  is internally pulled high with a  $50\text{k}\Omega$  resistor to  $V_{\text{LOGIC}}$ .

### Volume Control

In volume-control mode, the MAX5456/MAX5457s' wipers move simultaneously, maintaining the balance separation between each wiper (Figure 3a).

When either wiper reaches the maximum tap position (position closest to  $H_{-}$ ), further commands to increase the volume are ignored. Balance separation is maintained in the maximum volume configuration (Figure 3b).

When either wiper reaches the minimum tap position (position closest to  $L_{-}$ ), further commands to decrease the volume adjust the other wiper until it also reaches the minimum tap position (Figure 3c).

Increasing the volume from this minimum position restores the original balance separation of the wipers (Figure 3d).

When both wipers are in the 31st tap position (-62dB attenuation), further commands to  $\overline{\text{VOLDN}}$  place the wipers in the mute position (see Table 1).  $\overline{\text{VOLUP}}$  or  $\overline{\text{MUTE}}$  pulses return wipers to position 31.

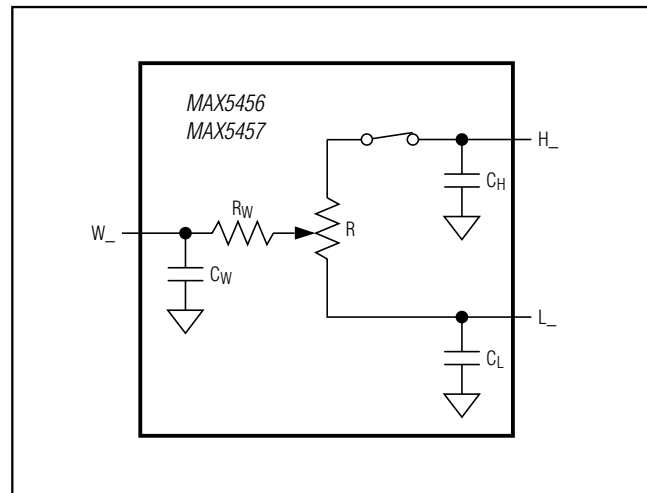

Figure 1. Potentiometer Model (Active)

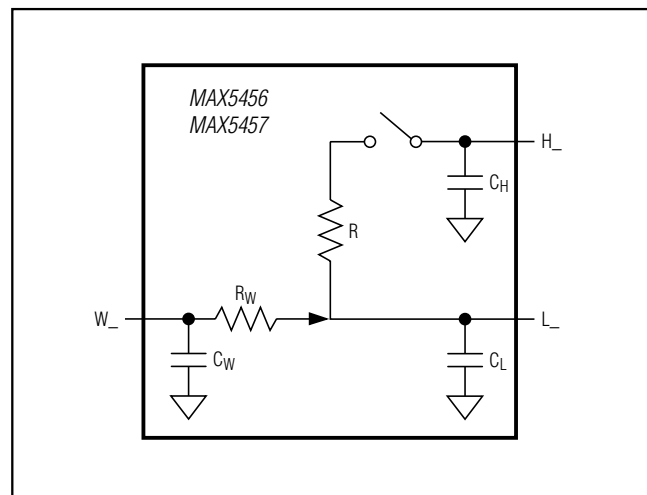

Figure 2. Potentiometer Model (Shutdown)

# MAX5456/MAX5457

## Stereo Audio Taper Potentiometers with Pushbutton Interface

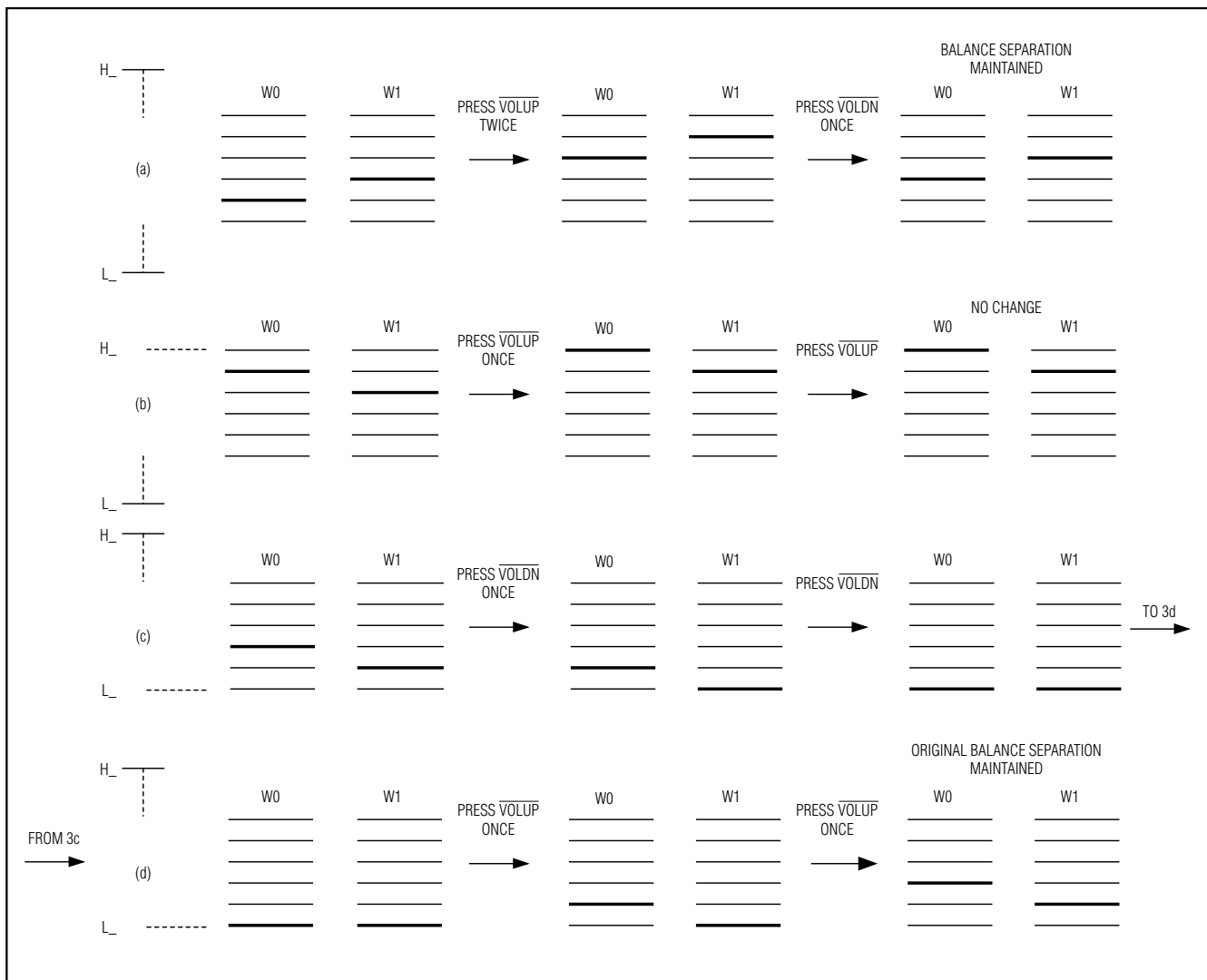

Figure 3. Volume-Control Operation

Table 1. Wiper Position and Attenuation

| POSITION  | ATTENUATION (dB) |
|-----------|------------------|
| 0         | 0                |
| 1         | 2                |
| 2         | 4                |
| ⋮         | ⋮                |
| 6 (POR)   | 12               |
| ⋮         | ⋮                |
| 30        | 60               |
| 31        | 62               |
| 32 (mute) | >90              |

# MAX5456/MAX5457

## Stereo Audio Taper Potentiometers with Pushbutton Interface

### Balance Control

In balance-control mode, the MAX5456/MAX5457 adjust the balance between channel 0 and channel 1 while maintaining the set volume. For example, if the volume of channel 0 equals the volume of channel 1, forcing the balance towards channel 1 increases the attenuation of channel 0 (Figure 4a). If channel 1 is at a higher attenuation than channel 0, adjusting the balance to channel 1 moves channel 1's wiper up to the same wiper position as channel 0 before attenuating channel 0 (Figure 4b).

To control the wiper quickly with a logic signal, maintain pulses at least 22.5ms wide and separated by at least 40ms.

**Table 2. Wiper Action vs. Pushbutton Contact Duration**

| CONTACT DURATION                   | WIPER ACTION                              |
|------------------------------------|---|
| $t < 22.5\text{ms}$                | No motion (debouncing).                   |
| $22.5\text{ms} < t \leq 1\text{s}$ | Wiper changes position once.              |
| $1\text{s} < t \leq 4\text{s}$     | Wiper changes position at a rate of 4Hz.  |
| $t > 4\text{s}$                    | Wiper changes position at a rate of 16Hz. |

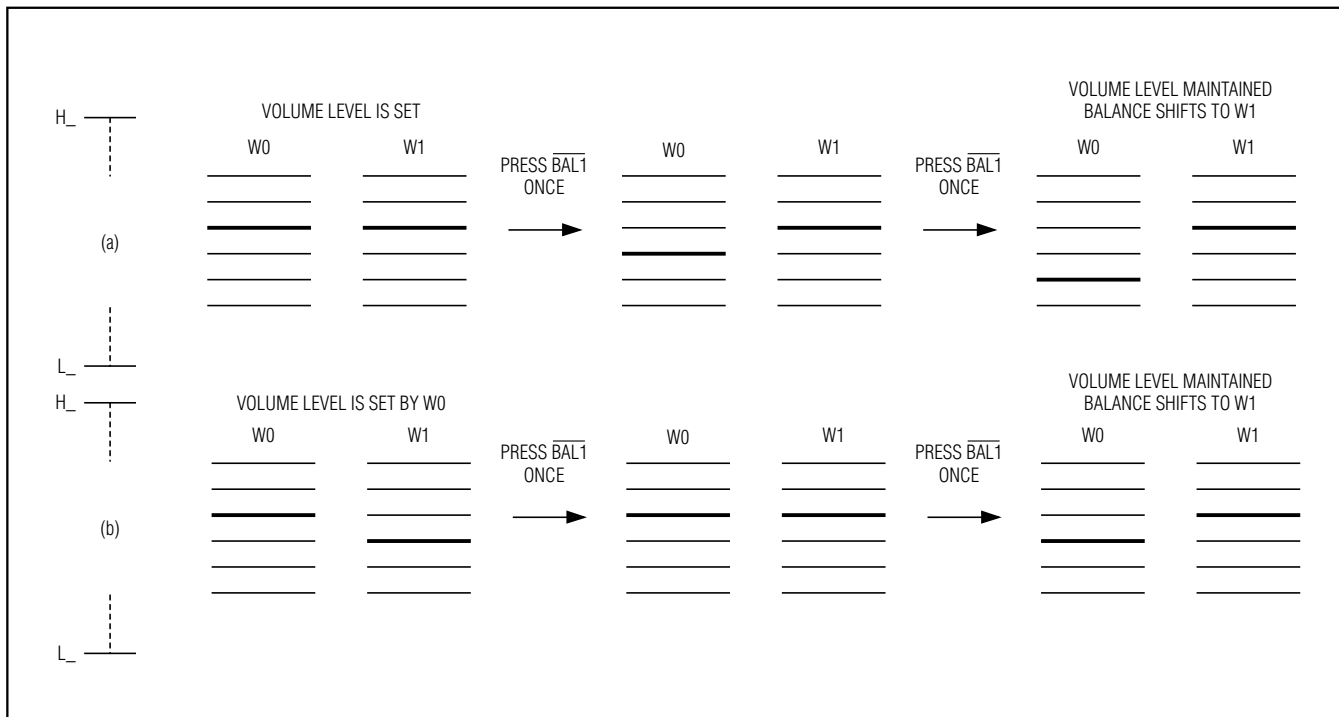

Figure 4. Balance-Control Operation

# MAX5456/MAX5457

## Stereo Audio Taper Potentiometers with Pushbutton Interface

### Click/Pop Suppression

The click/pop suppression feature reduces the audible noise (clicks and pops) that result from wiper transitions. The MAX5456/MAX5457 minimize this noise by allowing the wiper position changes only when the voltage at  $L_-$  is the same as the voltage at the corresponding  $H_-$ . Each wiper has its own suppression and timeout circuitry (see Figure 5a). The MAX5456/MAX5457 change wiper position after 32ms or when  $V_{H_-} = V_{L_-}$ , whichever occurs first (see Figure 5b).

The suppression circuitry monitors left and right channels separately. In volume-control mode, when the first wiper changes position, the second wiper has 32ms to change or it will be forced to change.

### Power-On Reset

The power-on comparators monitor  $V_{DD} - V_{SS}$  and  $V_{LOGIC} - GND$ . A power-on reset is initiated when either of the supplies is brought back to normal operating voltage. The power-on-reset feature sets both wipers to -12dB. Power-on reset places the MAX5457 in volume-control mode.

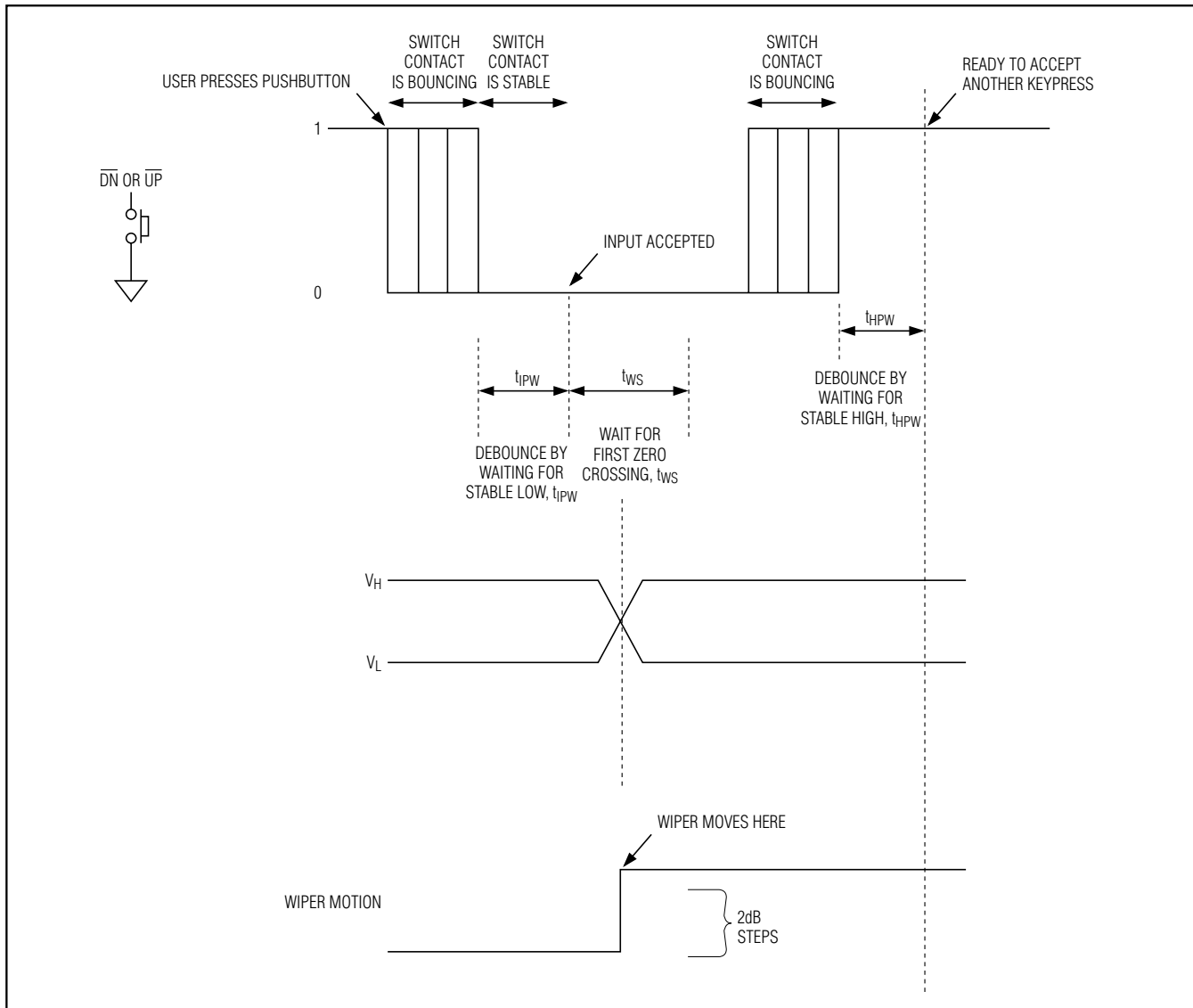

Figure 5a. Wiper Transition Timing Diagram

# MAX5456/MAX5457

## Stereo Audio Taper Potentiometers with Pushbutton Interface

### Shutdown, $\overline{SHDN}$

Upon entering shutdown mode, the MAX5456/MAX5457 store the last wiper settings. The wipers move to the L\_ end of the resistor string, and the H\_ end of the resistor string disconnects from the signal input. Terminating shutdown mode restores the wipers to their previous settings (see Figure 2). Shutdown does not affect the state of MODE\_IND.

### Mute Function, $\overline{MUTE}$

The MAX5456/MAX5457 feature a mute function. Successive pulses on MUTE toggle its setting. Activating the mute

function forces both wipers to maximum attenuation (-90dB typ). Deactivating the mute function returns the wipers to their previous settings. Pressing VOLUP also deactivates mute, setting the wipers to their previous positions. MUTE is internally pulled high with a 50k $\Omega$  resistor to VLOGIC. When both wipers are in the 31st tap position (-62dB attenuation), further commands to VOLDN place the wipers in the mute position (see Table 1). VOLUP or MUTE pulses return the wipers to position 31.

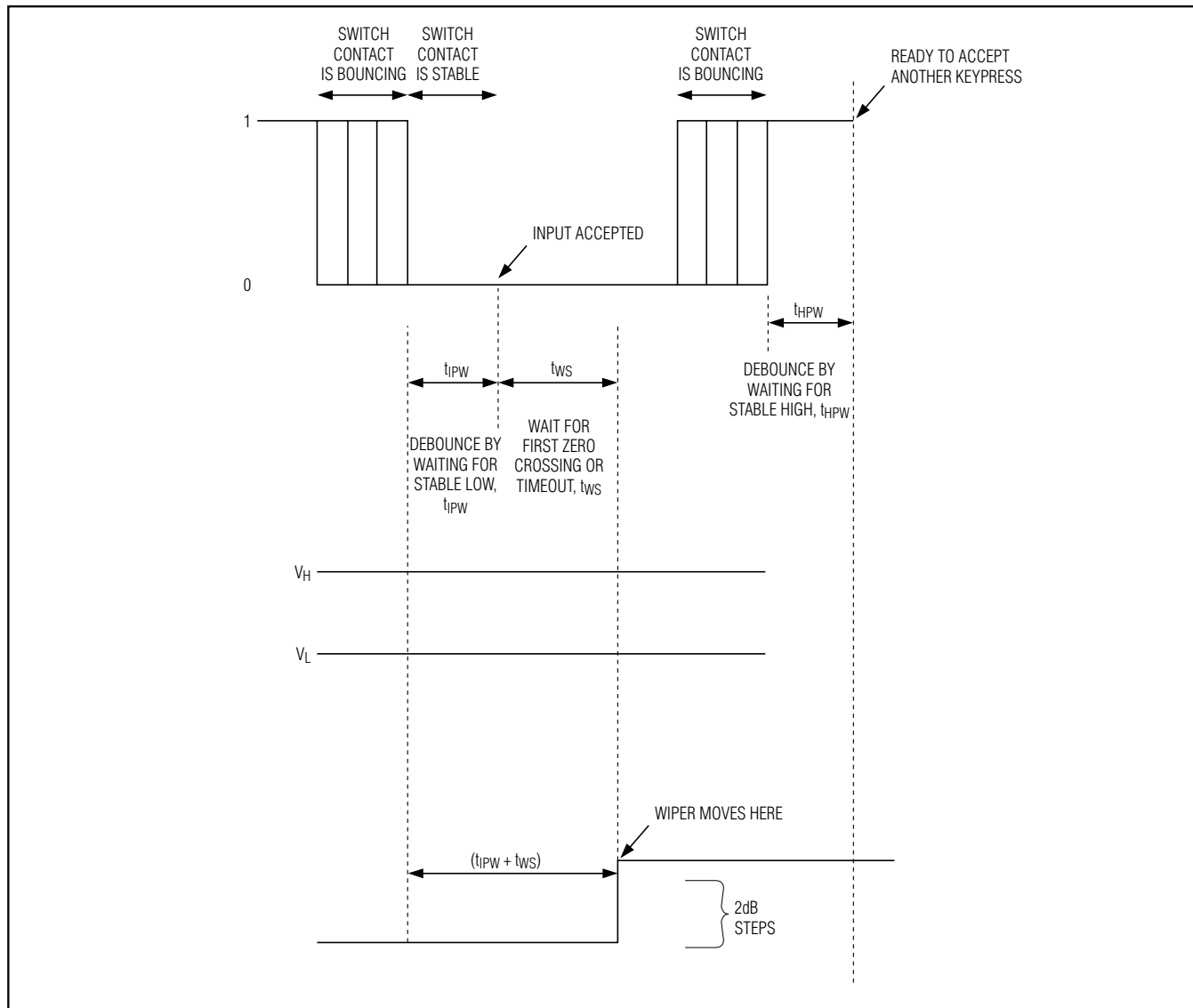

Figure 5b. Wiper Transition Timing Diagram

# MAX5456/MAX5457

## Stereo Audio Taper Potentiometers with Pushbutton Interface

### **Mode Control, $\overline{\text{MODE}}$**

The MAX5457  $\overline{\text{MODE}}$  input toggles between volume- and balance-control modes. Force  $\overline{\text{MODE}}$  low to toggle between volume-control and balance-control modes. For example, driving  $\overline{\text{MODE}}$  low once while in volume-control mode, switches the MAX5457 to balance-control mode. Driving mode low once again, switches the MAX5457 back to volume-control mode.  $\overline{\text{MODE}}$  is internally pulled high with a 50k $\Omega$  resistor to  $V_{\text{LOGIC}}$ . The MAX5457 powers up in volume-control mode.

### **Mode Indicator, $\text{MODE\_IND}$**

$\text{MODE\_IND}$  is the volume-control and balance-control mode indicator with an open-drain output. Connect  $\text{MODE\_IND}$  to an LED through a pullup resistor to  $V_{\text{LOGIC}}$ . When the LED is on, the MAX5457 is in balance-control mode. When the LED is off, the MAX5457 is in volume-control mode. See the *Mode Control,  $\overline{\text{MODE}}$*  section for more detail on switching between modes. Shutdown does not affect the state of  $\text{MODE\_IND}$ .

### **Multiple Button Pushes**

The MAX5456/MAX5457 do not respond to simultaneous button pushes. Pushing more than one button at the same time stops the wipers in their present states. Only a single button push configures the device. Additionally, a 40ms blocking period affects all other inputs when releasing any input forced low. The MAX5456/MAX5457 do not respond to any logic input until the blocking period ends. If multiple wiper-control buttons are pressed, all wiper-control connections must be released before the part will respond to further commands.

## **Applications Information**

### **Stereo Volume/Balance Control**

Figure 6 shows a volume/balance application using the MAX5457. The op amp is connected in a follower (non-inverting gain) configuration to isolate the potentiometer's wiper impedance from the load and provide drive capability. Connect the  $W_-$  of the MAX5457 to the positive input of a noninverting gain amp. The pushbutton potentiometers attenuate the input signals. Use the  $\overline{\text{MODE}}$  input to switch between volume-control and balance-control modes.

# MAX5456/MAX5457

## Stereo Audio Taper Potentiometers with Pushbutton Interface

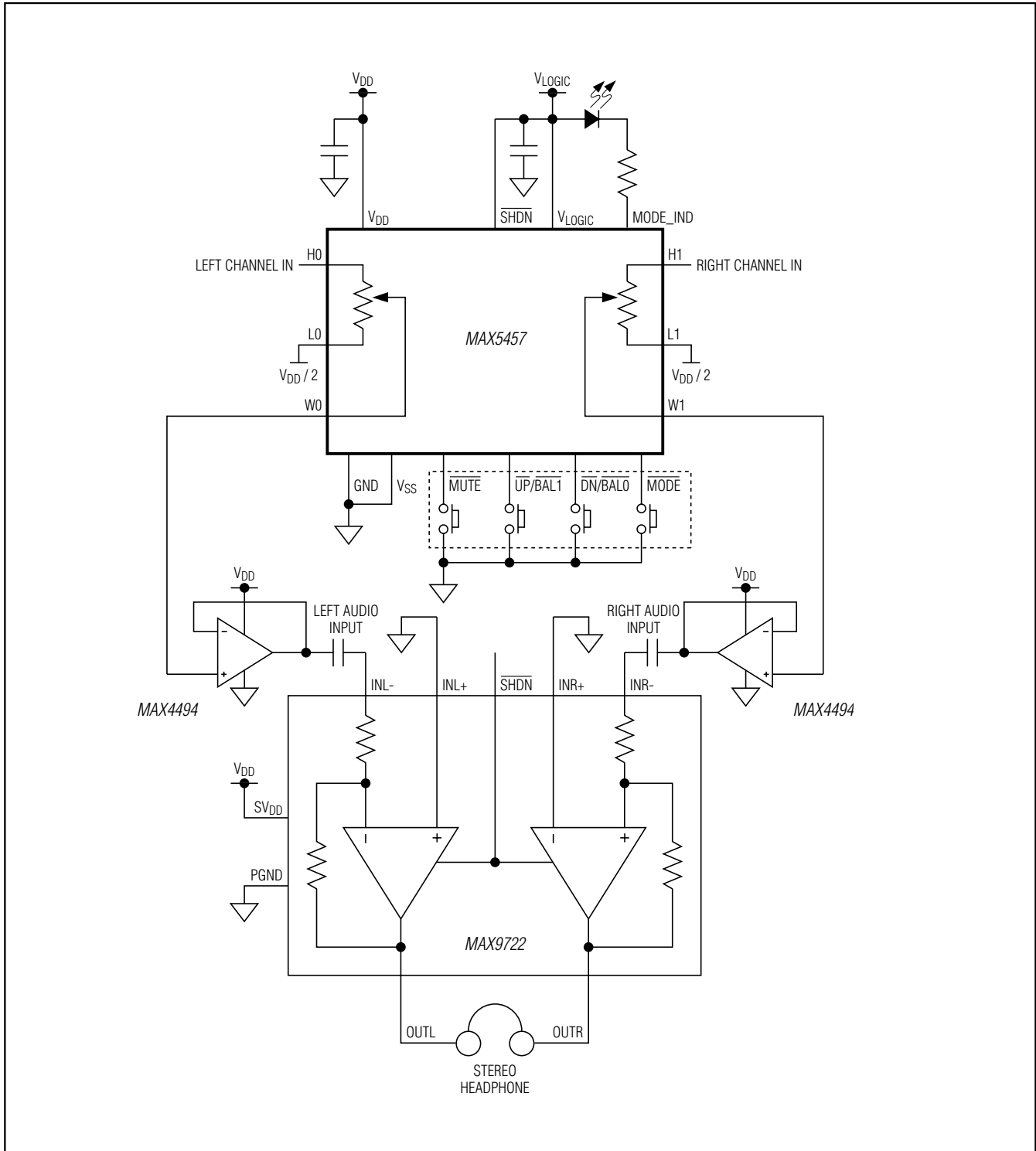

Figure 6. Volume/Balance Control



# MAX5456/MAX5457

## Stereo Audio Taper Potentiometers with Pushbutton Interface

### Functional Diagrams

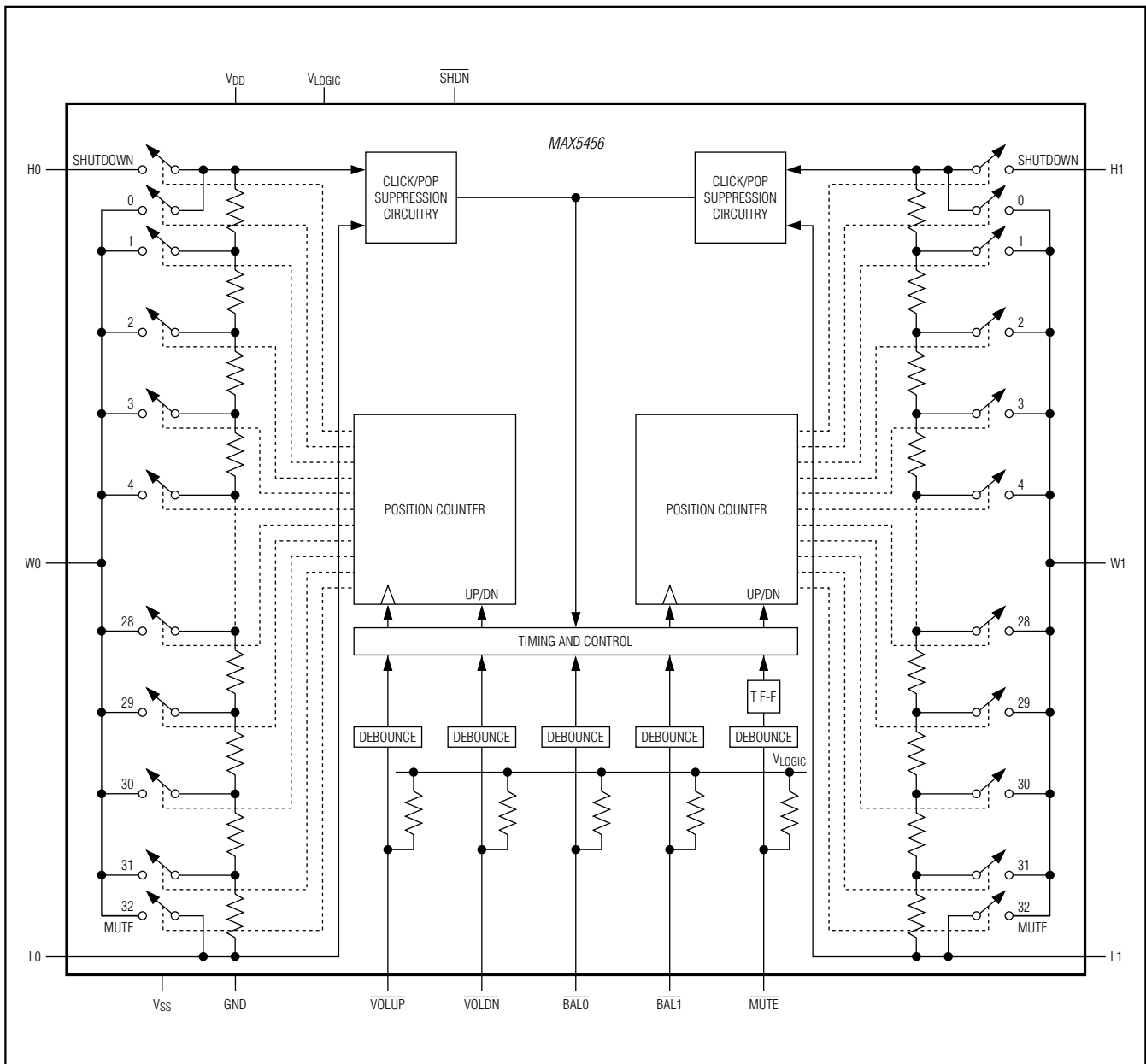

# MAX5456/MAX5457

## Stereo Audio Taper Potentiometers with Pushbutton Interface

### Functional Diagrams (continued)

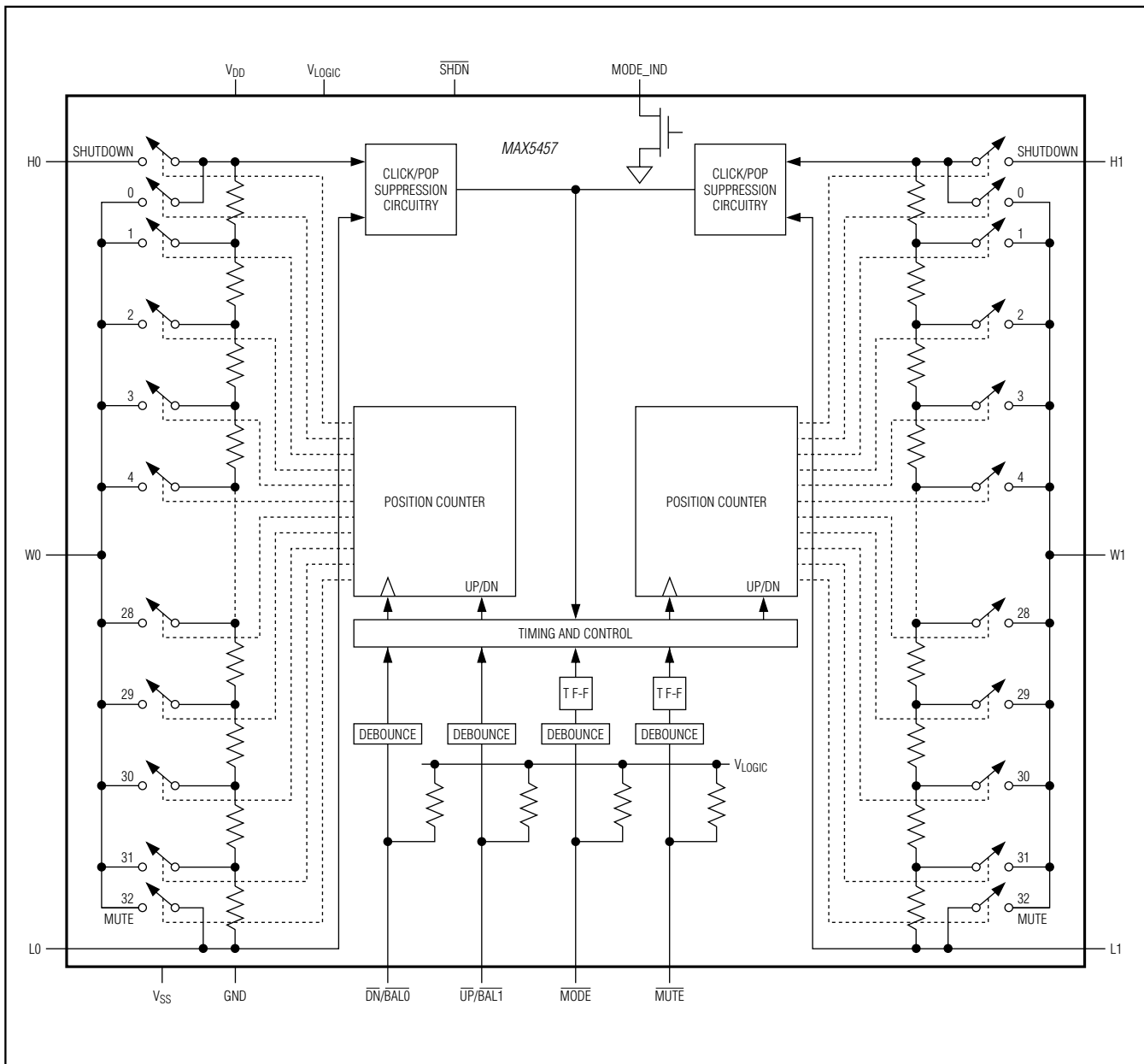

# MAX5456/MAX5457

## Stereo Audio Taper Potentiometers with Pushbutton Interface

### Pin Configurations (continued)

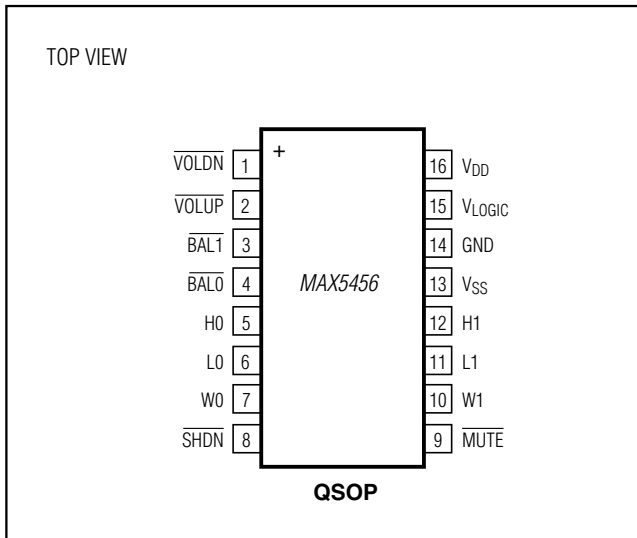

### Chip Information

PROCESS: CMOS

### Package Information

For the latest package outline information and land patterns (footprints), go to [www.maximintegrated.com/packages](http://www.maximintegrated.com/packages). Note that a "+", "#", or "-" in the package code indicates RoHS status only. Package drawings may show a different suffix character, but the drawing pertains to the package regardless of RoHS status.

| PACKAGE TYPE | PACKAGE CODE | OUTLINE NO.             | LAND PATTERN NO.        |
|--------------|--------------|-------------------------|-------------------------|
| 16 QSOP      | E16+1        | <a href="#">21-0055</a> | <a href="#">90-0167</a> |

# MAX5456/MAX5457

## Stereo Audio Taper Potentiometers with Pushbutton Interface

### Revision History



| REVISION NUMBER | REVISION DATE | DESCRIPTION   | PAGES CHANGED         |
|-----------------|---------------|---|-----------------------|
| 0               | 11/04         | Initial release   | —                     |
| 2               | 8/12          | Update <i>Ordering Information</i> , <i>Absolute Maximum Ratings</i> , <i>Pin Description</i> , <i>Pin Configuration</i> . Removed <i>Selector Guide</i> and added <i>Package Information</i> table and <i>Revision History</i> . | 1, 2, 6, 14,<br>18–20 |



Maxim Integrated cannot assume responsibility for use of any circuitry other than circuitry entirely embodied in a Maxim Integrated product. No circuit patent licenses are implied. Maxim Integrated reserves the right to change the circuitry and specifications without notice at any time. The parametric values (min and max limits) shown in the Electrical Characteristics table are guaranteed. Other parametric values quoted in this data sheet are provided for guidance.

## Looking for pricing, stock, or lifecycle information?

Click below to explore more details on WIN SOURCE:

-  [View MAX5457EEE+T on WIN SOURCE](#)
-  [Maxim Integrated Information](#)

## Optimize Your Supply Chain with WIN SOURCE Solutions

-  Global Sourcing Solution
-  Obsolete Management
-  Cost Control Management
-  Shortage Management
-  Alternative Solution
-  Excess Inventory Management