

MAX4951C

6Gbps SATA Bidirectional Redriver with Input Equalization, Preemphasis, and Advanced Power Management

General Description

The MAX4951C dual-channel buffer with input equalization and preemphasis is ideal to redrive internal serial-ATA (SATA) 1i, 2i, and 3i signals as well as eSATA 1m and 2m signals. The device features high electrostatic discharge (ESD) $\pm 8\text{kV}$ Human Body Model (HBM) protection. The device can be placed near a SATA connector on the motherboard to overcome board losses and guarantee SATA compliance. The device is SATA specification version 3.0 (gold standard) compliant and can also be pin-configured for SATA specification version 2.6 (gold standard) compliance.

The device features hardware SATA-drive cable detection that automatically places the device into a standby mode that consumes less than $20\mu\text{A}$ (typ) standby current when no drive is connected. In addition, the device features an independent channel dynamic power-down mode where power consumption is reduced when no input signal is present. The device maintains output common-mode levels to meet internal SATA version 3.0 standards and prevent delays when coming out of low-power mode.

The device preserves signal integrity at the receiver by reestablishing full output levels and reducing the total system jitter (T_j) by providing equalization. The device features channel-independent digital preemphasis controls to drive SATA outputs over longer trace lengths to meet internal SATA specifications. SATA out-of-band (OOB) signaling is supported using high-speed out-of-band signal detection on the inputs, and squelch on the corresponding outputs. Inputs and outputs are all internally 50Ω terminated and must be AC-coupled to the SATA controller IC and SATA device.

The device operates from a single $+3.3\text{V}$ (typ) supply, is available in a small, $4\text{mm} \times 4\text{mm}$ TQFN package with flow-through traces for ease of layout, and is specified over the commercial 0°C to $+70^\circ\text{C}$ operating temperature range. The MAX4951C is also pin compatible with the MAX4951BE SATA 6.0Gbps redriver.

Ordering Information appears at end of data sheet.

Benefits and Features

- ◆ **Unique Design Saves Power**
 - ◇ Low-Power, $20\mu\text{A}$ (typ) SATA Cable/Drive Detect
 - ◇ Dynamic Power Reduction
 - Reduced Power Consumption When Idle
 - Maintains Common-Mode Output Level
 - No Loss of Data When Coming Out of Low-Power Mode
- ◆ **Allows Design Flexibility**
 - ◇ Single $+3.3\text{V}$ Supply Operation
 - ◇ SATA 3i (6.0Gbps) and SATA 2i/2m (3.0Gbps) Compliant
 - ◇ SATA 1i/1m (1.5Gbps) Compatible
- ◆ **Permits Longer Trace Lengths**
 - ◇ Input Equalization
 - ◇ Selectable Output Preemphasis
- ◆ **High Level of Integration for Performance**
 - ◇ Excellent Input/Output Return Loss Up to 6Gbps
 - ◇ Supports SATA 2i and 3i Output Levels
 - ◇ Supports SATA OOB Signaling
 - ◇ OOB Detection: 3ns (typ)
 - ◇ High ESD Protection on All Pins: $\pm 8\text{kV}$ (HBM)
- ◆ **Saves Board Space**
 - ◇ On-Chip 50Ω Input/Output Termination Resistors
 - ◇ Inline Signal Traces for Flow-Through Layout
 - ◇ Space-Saving, $4\text{mm} \times 4\text{mm}$ TQFN Package with Exposed Pad
 - ◇ Pin Compatible with the MAX4951BE

Applications

Laptop Computers
 Servers
 Desktop Computers
 Docking Stations
 Data Storage/Workstations

For related parts and recommended products to use with this part, refer to: www.maxim-ic.com/MAX4951C.related

6Gbps SATA Bidirectional Redriver with Input Equalization, Preemphasis, and Advanced Power Management

ABSOLUTE MAXIMUM RATINGS

(All voltages referenced to GND, unless otherwise noted.)

| | |
|---|-----------------------------------|
| V _{CC} | -0.3V to +4.0V |
| AINP, AINM, BINP, BINM, EN, $\overline{\text{CAD}}$, MODE, PA, PB (Note 1)..... | -0.3V to (V _{CC} + 0.3V) |
| Short-Circuit Output Current BOUTP, BOUTM, AOUTP, AOUTM..... | ±30mA |
| Continuous Current at Inputs AINP, AINM, BINP, BINM..... | ±5mA |

Continuous Power Dissipation (T_A = +70°C)

| | |
|--|-----------------|
| TQFN (derate 25.6mW/°C above +70°C)..... | 2051mW |
| Operating Temperature Range..... | 0°C to +70°C |
| Storage Temperature Range..... | -55°C to +150°C |
| Lead Temperature (soldering, 10s)..... | +300°C |
| Soldering Temperature (reflow)..... | +260°C |

Note 1: All I/O pins are clamped by internal diodes.

Stresses beyond those listed under "Absolute Maximum Ratings" may cause permanent damage to the device. These are stress ratings only, and functional operation of the device at these or any other conditions beyond those indicated in the operational sections of the specifications is not implied. Exposure to absolute maximum rating conditions for extended periods may affect device reliability.

PACKAGE THERMAL CHARACTERISTICS (Note 2)

TQFN

| | |
|--|--------|
| Junction-to-Ambient Thermal Resistance (θ _{JA})..... | 39°C/W |
| Junction-to-Case Thermal Resistance (θ _{JC})..... | 6°C/W |

Note 2: Package thermal resistances were obtained using the method described in JEDEC specification JESD51-7, using a four-layer board. For detailed information on package thermal considerations, refer to www.maxim-ic.com/thermal-tutorial.

ELECTRICAL CHARACTERISTICS

(V_{CC} = +3.0V to +3.6V, C_{CL} = 10nF coupling capacitor on each output, R_L = 50Ω, T_A = 0°C to +70°C, unless otherwise noted. Typical values are at V_{CC} = +3.3V, T_A = +25°C.) (Note 3)

| PARAMETER | SYMBOL | CONDITIONS | MIN | TYP | MAX | UNITS |
|---|-------------------------|---|-----|-----|-----|-------|
| Operating Power-Supply Range | V _{CC} | | 3.0 | | 3.6 | V |
| Operating Supply Current | I _{CC} | PA = PB = V _{CC} , D10.2 pattern, f = 3GHz, active state | | 70 | 100 | mA |
| | | PA = PB = GND, D10.2 pattern, f = 3GHz, active state | | 60 | 85 | |
| Standby Supply Current | I _{STBY} | EN = GND or $\overline{\text{CAD}}$ = V _{CC} | | 20 | 500 | μA |
| Dynamic Power-Down Current | I _{DYNPD} | | | 16 | 20 | mA |
| Differential Input Resistance | Z _{RX-DIFF-DC} | (Note 4) | 85 | 100 | 115 | Ω |
| Differential Output Resistance | Z _{TX-DIFF-DC} | (Note 4) | 85 | 100 | 115 | Ω |
| AC PERFORMANCE | | | | | | |
| Differential Input Return Loss (Notes 4, 5) | RL _{RX-DIFF} | 150MHz ≤ f < 300MHz | | 18 | | dB |
| | | 300MHz ≤ f < 600MHz | | 14 | | |
| | | 600MHz ≤ f < 1200MHz | | 10 | | |
| | | 1.2GHz ≤ f < 2.4GHz | | 8 | | |
| | | 2.4GHz ≤ f ≤ 3.0GHz | | 3 | | |

6Gbps SATA Bidirectional Redriver with Input Equalization, Preemphasis, and Advanced Power Management

ELECTRICAL CHARACTERISTICS (continued)

($V_{CC} = +3.0V$ to $+3.6V$, $C_{CL} = 10nF$ coupling capacitor on each output, $R_L = 50\Omega$, $T_A = 0^\circ C$ to $+70^\circ C$, unless otherwise noted. Typical values are at $V_{CC} = +3.3V$, $T_A = +25^\circ C$.) (Note 3)

| PARAMETER | SYMBOL | CONDITIONS | MIN | TYP | MAX | UNITS |
|--|----------------------------|--|------|-----|------|-------------------|
| Common-Mode Input Return Loss (Notes 4, 5) | RL _{RX-CM} | 150MHz ≤ f < 300MHz | 5 | | | dB |
| | | 300MHz ≤ f < 600MHz | 5 | | | |
| | | 600MHz ≤ f < 1200MHz | 2 | | | |
| | | 1.2GHz ≤ f < 2.4GHz | 2 | | | |
| | | 2.4GHz ≤ f ≤ 3.0GHz | 2 | | | |
| Differential Output Return Loss (Notes 4, 5) | RL _{TX-DIFF} | 150MHz ≤ f < 300MHz | 14 | | | dB |
| | | 300MHz ≤ f < 600MHz | 8 | | | |
| | | 600MHz ≤ f < 1200MHz | 6 | | | |
| | | 1.2GHz ≤ f < 2.4GHz | 6 | | | |
| | | 2.4GHz ≤ f ≤ 3.0GHz | 3 | | | |
| Common-Mode Output Return Loss (Notes 4, 5) | RL _{TX-CM} | 150MHz ≤ f < 300MHz | 8 | | | dB |
| | | 300MHz ≤ f < 600MHz | 5 | | | |
| | | 600MHz ≤ f < 1200MHz | 2 | | | |
| | | 1.2GHz ≤ f < 2.4GHz | 2 | | | |
| | | 2.4GHz ≤ f ≤ 3.0GHz | 1 | | | |
| Differential Input Signal Range | V _{RX-DIFF-PP} | SATA 2i, SATA 3i, MODE = GND (Note 4) | 240 | | 1000 | mV _{P-P} |
| | | SATA 2i, SATA 3i, MODE = V _{CC} (Note 6) | 220 | | 1000 | |
| Differential Output Swing | V _{TX-DIFF-PP} | f = 750MHz, f = 3.0GHz, PA = PB = GND (Notes 4, 6) | 400 | | 700 | mV _{P-P} |
| Output Preemphasis | V _{TX-DIFF-PP-PE} | f = 750MHz, PA = PB = V _{CC} | | 3 | | dB |
| Input Equalization | V _{RX-DIFF-PP-EQ} | V _{RX-DIFF-PP} = 300mV _{P-P} | | 2.7 | | dB |
| Preemphasis Time Period | t _{PE} | f = 750MHz, PA = PB = V _{CC} | | 150 | | ps |
| Propagation Delay | t _{PD} | | | 240 | | ps |
| Output Rise/Fall Time | t _{TX-RISE-FALL} | PA = PB = GND, C _L = 0.5pF (Notes 5, 7) | 40 | | | ps |
| Deterministic Jitter (Notes 5, 8) | t _{TX-DJ-DD} | Data rate = 3.0Gbps, PA = PB = GND | | | 17 | pSP-P |
| | | Data rate = 6.0Gbps, PA = PB = GND | | | 20 | |
| Random Jitter | t _{TX-RJ-DD} | PA = PB = GND (Notes 5, 8) | | | 1.5 | pSRMS |
| OOB Detector Threshold | V _{OOB_TH} | SATA OOB pattern, MODE = GND (Note 4) | 75 | | 200 | mV _{P-P} |
| | | SATA OOB pattern, MODE = V _{CC} (Note 6) | 50 | | 150 | |
| OOB Output Enter/Exit Time | t _{OOB} | (Note 9) | | 3 | 5 | ns |
| OOB Differential Offset Delta | ΔV _{OOB-DIFF} | (Note 10) | -100 | | +100 | mV |

6Gbps SATA Bidirectional Redriver with Input Equalization, Preemphasis, and Advanced Power Management

ELECTRICAL CHARACTERISTICS (continued)

($V_{CC} = +3.0V$ to $+3.6V$, $C_{CL} = 10nF$ coupling capacitor on each output, $R_L = 50\Omega$, $T_A = 0^\circ C$ to $+70^\circ C$, unless otherwise noted. Typical values are at $V_{CC} = +3.3V$, $T_A = +25^\circ C$.) (Note 3)

| PARAMETER | SYMBOL | CONDITIONS | MIN | TYP | MAX | UNITS |
|----------------------------------|---------------------|--|-----|---------|-----|-------------------|
| OOB Common-Mode Delta | ΔV_{OOB-CM} | (Note 10) | -50 | | +50 | mV |
| OOB Output Disable | $V_{OOB-OUT}$ | $V_{IN} < V_{CCB}$ (min), output voltage in squelch (Note 5) | | | 30 | mV _{p-p} |
| Dynamic Power-Down Exit Time | t_{DPD} | SATA OOB pattern | | | 20 | ns |
| Output Common-Mode Delta | ΔV_{OUT-CM} | (Note 11) | -25 | | +25 | mV |
| LOGIC INPUT | | | | | | |
| Input Logic-High | V_{IH} | EN, \overline{CAD} , PA, PB, MODE | 1.4 | | | V |
| Input Logic-Low | V_{IL} | EN, \overline{CAD} , PA, PB, MODE | | | 0.6 | V |
| Input Logic Hysteresis | V_{HYST} | EN, \overline{CAD} , PA, PB, MODE | | 0.1 | | V |
| Input Pullup/Pulldown Resistance | R_{PU-PD} | | | 370 | | k Ω |
| ESD PROTECTION | | | | | | |
| All Pins | | Human Body Model | | ± 8 | | kV |

Note 3: All devices are 100% production tested at $T_A = +70^\circ C$. Specifications over the operating temperature range are guaranteed by design.

Note 4: This specification meets SATA version 3.0 (gold standard).

Note 5: Guaranteed by design.

Note 6: This specification meets SATA version 2.6 (gold standard).

Note 7: Rise and fall times are measured using 20% and 80% levels.

Note 8: DJ measured using K28.5 pattern; RJ measured using D10.2 pattern

Note 9: Total time for OOB detection circuit to enable/squelch the output.

Note 10: Difference between squelched and not squelched in the active mode.

Note 11: Difference between output common mode in the active and dynamic power-down state.

6Gbps SATA Bidirectional Redriver with Input Equalization, Preemphasis, and Advanced Power Management

Typical Operating Characteristics

($V_{CC} = +3.3V$, $T_A = +25^\circ C$, all eye diagrams measured using K28.5 pattern, unless otherwise noted.)

**VRX-DFF-PP = 240mVp-p, PA = GND,
DATA RATE = 1.5Gbps**

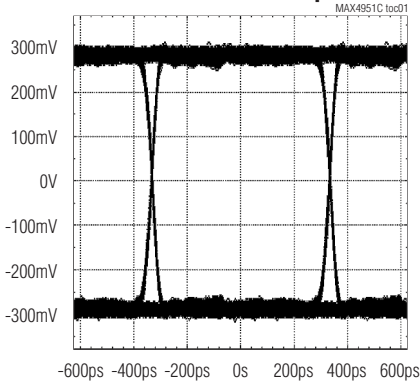

**VRX-DFF-PP = 240mVp-p, PA = GND,
DATA RATE = 3.0Gbps**

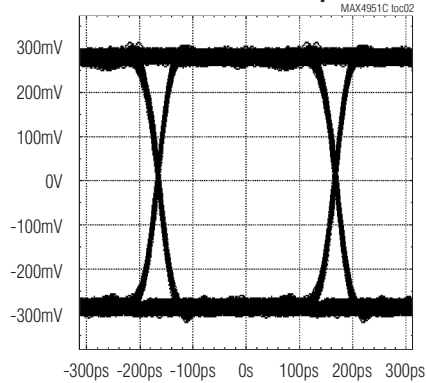

**VRX-DFF-PP = 240mVp-p, PA = GND,
DATA RATE = 6.0Gbps**

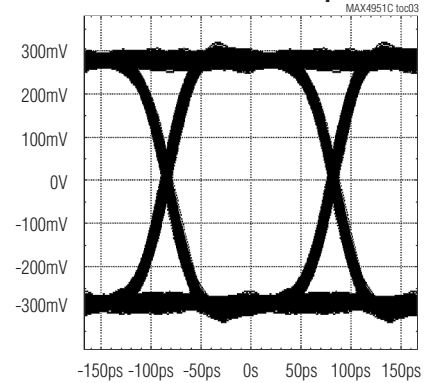

**VRX-DFF-PP = 1000mVp-p, PA = GND,
DATA RATE = 1.5Gbps**

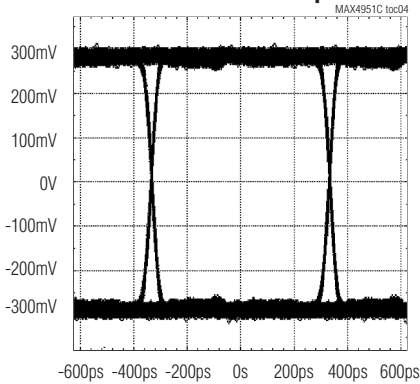

**VRX-DFF-PP = 1000mVp-p, PA = GND,
DATA RATE = 3.0Gbps**

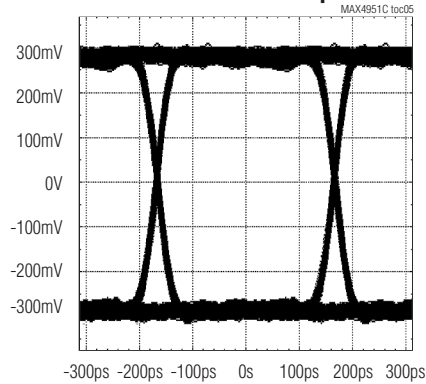

**VRX-DFF-PP = 1000mVp-p, PA = GND,
DATA RATE = 6.0Gbps**

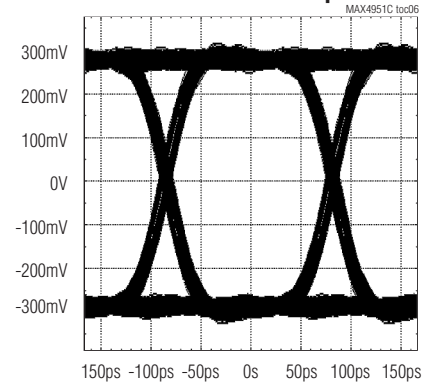

**VRX-DFF-PP = 240mVp-p, PA = Vcc,
DATA RATE = 1.5Gbps**

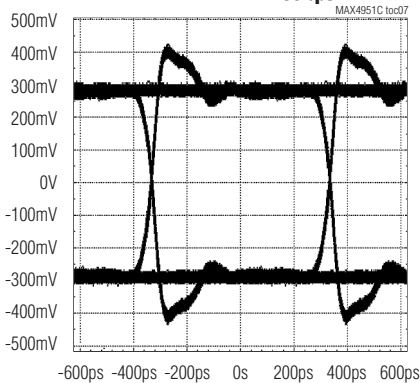

**VRX-DFF-PP = 240mVp-p, PA = Vcc,
DATA RATE = 3.0Gbps**

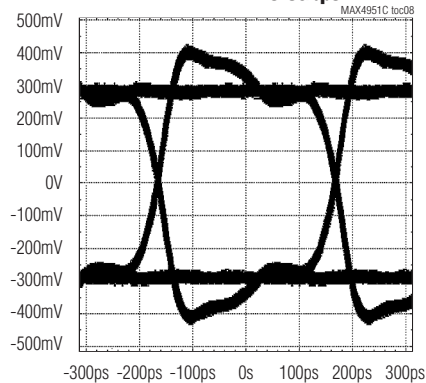

**VRX-DFF-PP = 240mVp-p, PA = Vcc,
DATA RATE = 6.0Gbps**

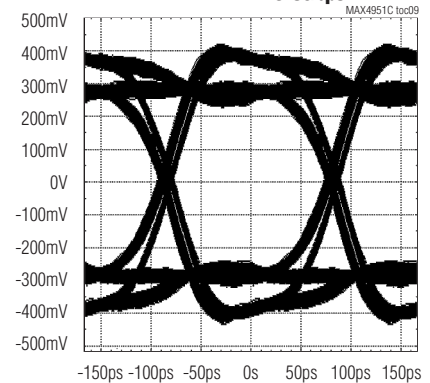

6Gbps SATA Bidirectional Redriver with Input Equalization, Preemphasis, and Advanced Power Management

Typical Operating Characteristics (continued)

($V_{CC} = +3.3V$, $T_A = +25^\circ C$, all eye diagrams measured using K28.5 pattern, unless otherwise noted.)

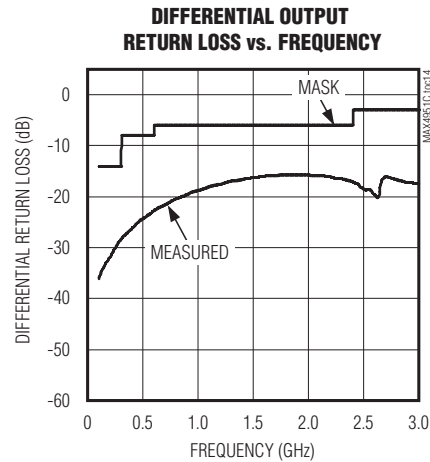
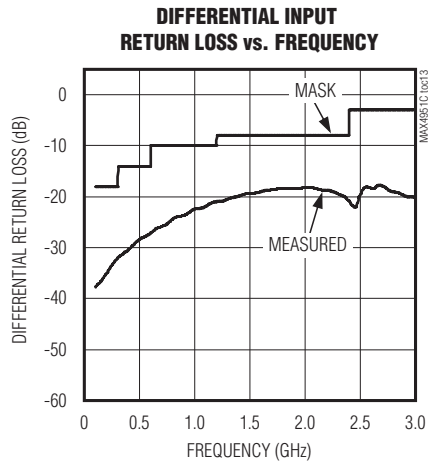
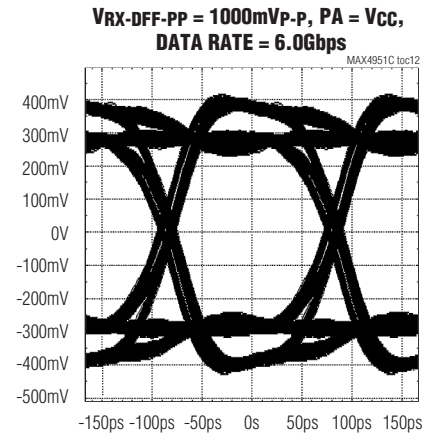
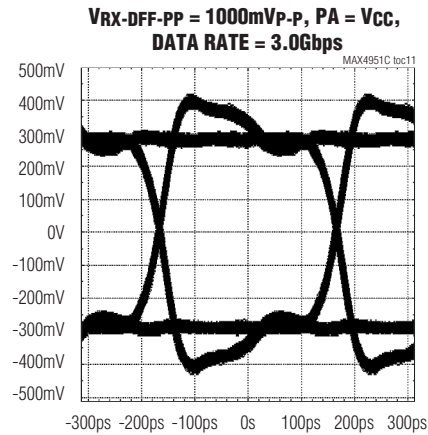
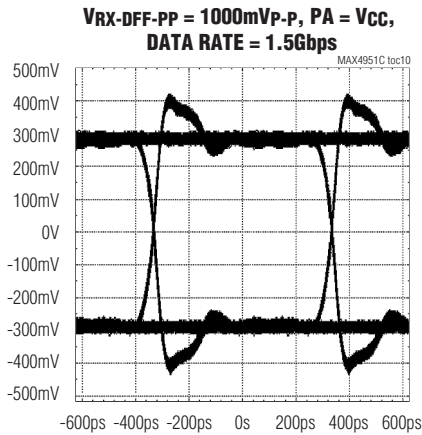

6Gbps SATA Bidirectional Redriver with Input Equalization, Preemphasis, and Advanced Power Management

Pin Configuration

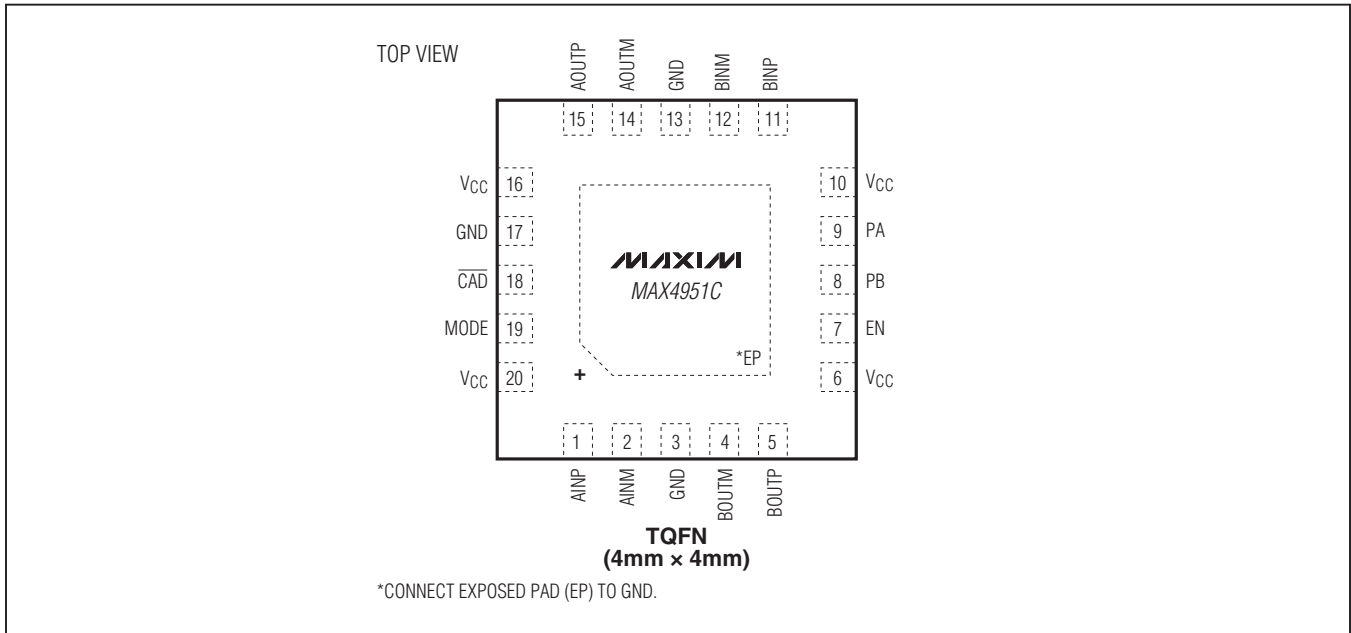

Pin Description

| PIN | NAME | FUNCTION |
|---------------|-----------------|--|
| 1 | AINP | Noninverting Input, Channel A |
| 2 | AINM | Inverting Input, Channel A |
| 3, 13, 17 | GND | Ground |
| 4 | BOUTM | Inverting Output, Channel B |
| 5 | BOUTP | Noninverting Output, Channel B |
| 6, 10, 16, 20 | V _{CC} | Positive Supply-Voltage Input. Bypass V _{CC} to GND with 1μF and 0.01μF capacitors in parallel as close as possible to the device. |
| 7 | EN | Active-High Enable Input. Drive EN low to put the device in standby mode. Drive EN high for normal operation. EN has a 390kΩ (typ) pulldown resistor. |
| 8 | PB | Channel B Preemphasis-Enable Input. Drive PB high to enable channel B output preemphasis. Drive PB low for standard SATA output level. PB has a 390kΩ (typ) pulldown resistor. |

| PIN | NAME | FUNCTION |
|-----|-------------------------|--|
| 9 | PA | Channel A Preemphasis-Enable Input. Drive PA high to enable channel A output preemphasis. Drive PA low for standard SATA output level. PA has a 390kΩ (typ) pulldown resistor. |
| 11 | BINP | Noninverting Input, Channel B |
| 12 | BINM | Inverting Input, Channel B |
| 14 | AOUTM | Inverting Output, Channel A |
| 15 | AOUTP | Noninverting Output, Channel A |
| 18 | $\overline{\text{CAD}}$ | Active-Low Cable-Detect Input. For external SATA applications, drive $\overline{\text{CAD}}$ high to put the device in standby mode. Drive $\overline{\text{CAD}}$ low for normal operation. $\overline{\text{CAD}}$ has a 390kΩ (typ) pullup resistor. For internal SATA applications, connect $\overline{\text{CAD}}$ to ground. |
| 19 | MODE | OOB Threshold Level Set. MODE has a 390kΩ (typ) pulldown resistor. |
| — | EP | Exposed Pad. Internally connected to GND. EP must be electrically connected to a ground plane for proper thermal and electrical operation. |

6Gbps SATA Bidirectional Redriver with Input Equalization, Preemphasis, and Advanced Power Management

Functional Diagram/Truth Table

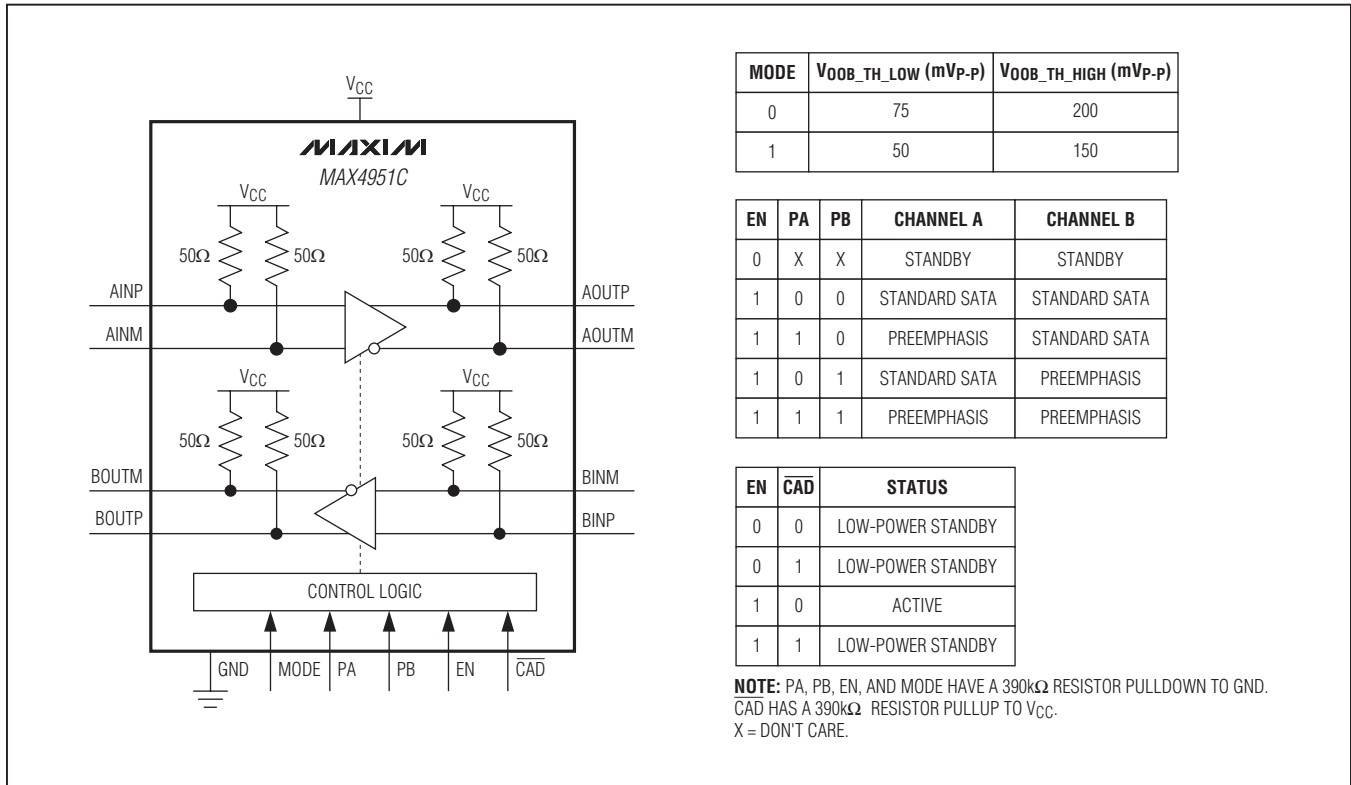

Detailed Description

The MAX4951C consists of two identical buffers that take SATA input signals and return them to full SATA compliant output levels. Each buffer includes an equalizer, a limiting amplifier, and an output driver with preemphasis. The buffer outputs are protected from high-voltage electrostatic discharge (ESD) to ±8kV Human Body Model (HBM).

Input/Output Terminations

Inputs and outputs are internally 50Ω terminated and must be AC-coupled to the SATA controller IC and SATA device for proper operation.

OOB Signal Detection

The device provides full OOB signal support through high-speed, OOB-detection circuitry. SATA OOB differential input signals of V_{OOB_TH_LOW} or less are detected as off and are not passed to the output. This prevents the

system from responding to unwanted noise. SATA OOB differential input signals of V_{OOB_TH_HIGH} or more are detected as on and passed to the output. This allows OOB signals to transmit through the device. The time for the OOB detection circuit to detect an inactive SATA OOB input and squelch the associated output, or detect an active SATA OOB input and enable the output, is 3ns (typ). The MODE pin can be used to program the OOB detection range. When MODE = GND, the SATA version 3.0 range is used. When MODE = V_{CC}, the SATA version 2.6 range is used.

Enable Input

The device features an active-high enable input (EN). EN has an internal pulldown resistor of 390kΩ (typ). Drive EN low or leave unconnected to place the device into low-power standby mode. In standby, the buffers are disabled, reducing the supply current to 20μA (typ). Drive EN high for normal operation.

6Gbps SATA Bidirectional Redriver with Input Equalization, Preemphasis, and Advanced Power Management

Cable-Detect Input

The device features an active-low, cable-detect input ($\overline{\text{CAD}}$) for use in external SATA applications. $\overline{\text{CAD}}$ has an internal 390k Ω (typ) pullup resistor. Drive $\overline{\text{CAD}}$ high or leave unconnected to place the device into low-power standby mode. In this mode, the buffers are disabled, reducing supply current to 20 μA (typ). This signal is normally driven low by inserting an internal SATA cable into a properly wired socket (see the [Typical Operating Circuit](#)). If the cable-detect feature is not desired, connect $\overline{\text{CAD}}$ to GND.

Dynamic Power-Down Mode

The device features a dynamic power-down mode where the device shuts down the major power consuming circuitry. The device detects if the input signal is not present for a 4 μs (typ) duration. Normal operation resumes after 20ns (max) when a signal above the OOB threshold level is detected at the input. This function is implemented separately for both channels. The output common mode remains virtually unchanged when entering or exiting

dynamic power-down mode, making the device ideal for internal SATA applications.

Output Preemphasis Selection Inputs

The device has two preemphasis control-logic inputs, PA and PB. PA and PB have internal 390k Ω (typ) pulldown resistors. PA and PB enable preemphasis to the outputs of their corresponding buffers (see the [Functional Diagram/Truth Table](#)). Drive PA or PB low or leave unconnected for standard SATA output levels. Drive PA or PB high to provide preemphasis to the output. The preemphasis output signal compensates for attenuation from longer trace lengths or to meet internal SATA specifications.

Applications Information

[Figure 1](#) shows a typical application with the device used to drive an internal SATA device. Set PB high and PA low for applications with board losses < 3dB between the MAX4951C and the connector.

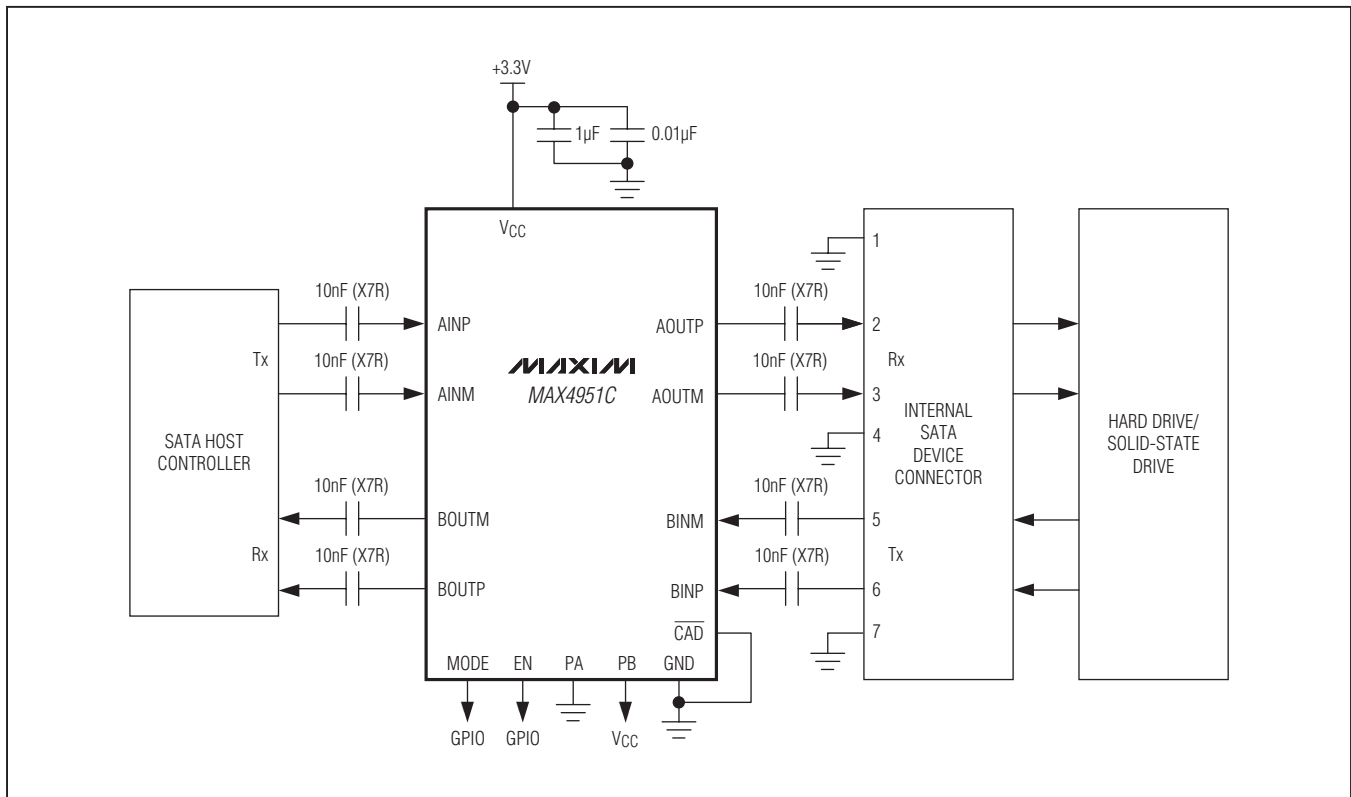

Figure 1. Typical Application Circuit for Internal SATA Applications

6Gbps SATA Bidirectional Redriver with Input Equalization, Preemphasis, and Advanced Power Management

Exposed-Pad Package

The exposed-pad, 20-pin TQFN package incorporates features that provide a very low-thermal resistance path for heat removal from the device. The exposed pad on the device must be soldered to GND for proper thermal and electrical performance. For more information on exposed-pad packages, refer to [Application Note 862: HFAN-08.1: Thermal Considerations of QFN and Other Exposed-Paddle Packages](#).

Layout

Use controlled-impedance transmission lines to interface with the device's high-speed inputs and outputs. Place power-supply decoupling capacitors as close as possible to the V_{CC} pin.

Power-Supply Sequencing

Caution: Do not exceed the absolute maximum ratings because stresses beyond the listed ratings can cause permanent damage to the device.

Proper power-supply sequencing is recommended for all devices. Always apply V_{CC} before applying signals, especially if the signal is not current limited.

ESD Protection

As with all Maxim devices, ESD protection structures are incorporated on all pins to protect against electrostatic discharges encountered during handling and assembly. The MAX4951C is protected against ESD events up to $\pm 8\text{kV}$ (HBM). The ESD structures withstand $\pm 8\text{kV}$ in all states: normal operation and powered down. After an ESD event, the device continues to function without latchup.

HBM

The device is rated for $\pm 8\text{kV}$ ESD protection using the HBM (MIL-STD-883, Method 3015). [Figure 2](#) shows the HBM voltage, and [Figure 3](#) shows the current waveform it generates when discharged into a low-impedance state. This model consists of a 100pF capacitor charged to the ESD voltage of interest that is then discharged into the device through a $1.5\text{k}\Omega$ resistor.

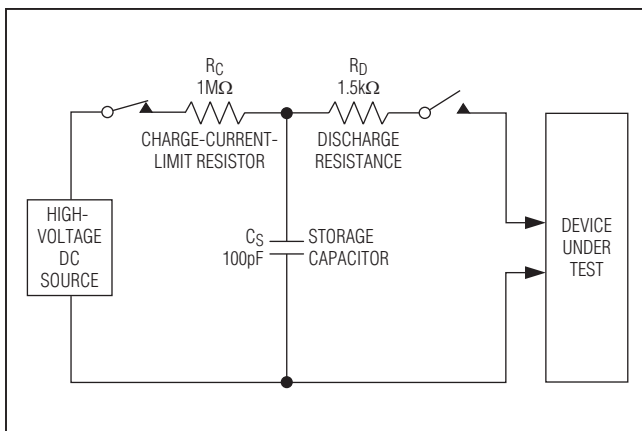

Figure 2. Human Body ESD Test Model

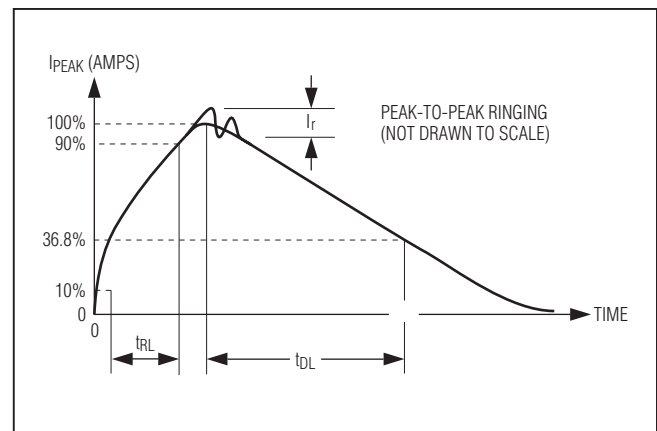
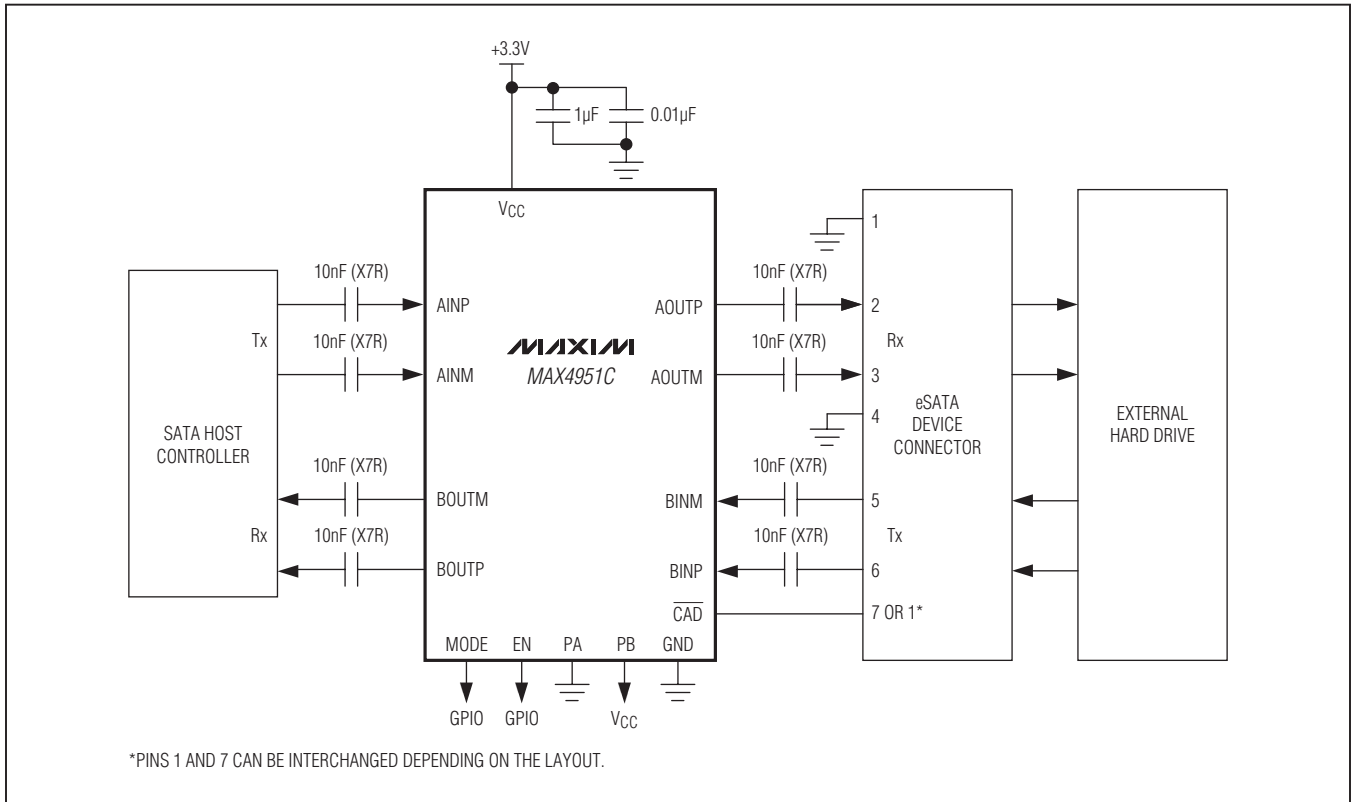

Figure 3. Human Body Current Waveform

MAX4951C

6Gbps SATA Bidirectional Redriver with Input Equalization, Preemphasis, and Advanced Power Management

Typical Operating Circuit



Ordering Information

| PART | TEMP RANGE | PIN-PACKAGE |
|--------------|--------------|-------------|
| MAX4951CCTP+ | 0°C to +70°C | 20 TQFN-EP* |

+Denotes a lead(Pb)-free/RoHS-compliant package.

*EP = Exposed pad.

Chip Information

PROCESS: BiCMOS

Package Information

For the latest package outline information and land patterns (footprints), go to www.maxim-ic.com/packages. Note that a "+", "#", or "-" in the package code indicates RoHS status only. Package drawings may show a different suffix character, but the drawing pertains to the package regardless of RoHS status.

| PACKAGE TYPE | PACKAGE CODE | OUTLINE NO. | LAND PATTERN NO. |
|--------------|--------------|-------------------------|-------------------------|
| 20 TQFN-EP | T2044+2 | 21-0139 | 90-0036 |

MAX4951C

6Gbps SATA Bidirectional Redriver with Input Equalization, Preemphasis, and Advanced Power Management

Revision History



| REVISION NUMBER | REVISION DATE | DESCRIPTION | PAGES CHANGED |
|-----------------|---------------|-----------------|---------------|
| 0 | 3/11 | Initial release | — |

Maxim cannot assume responsibility for use of any circuitry other than circuitry entirely embodied in a Maxim product. No circuit patent licenses are implied. Maxim reserves the right to change the circuitry and specifications without notice at any time. The parametric values (min and max limits) shown in the Electrical Characteristics table are guaranteed. Other parametric values quoted in this data sheet are provided for guidance.

Maxim Integrated Products, 120 San Gabriel Drive, Sunnyvale, CA 94086 408-737-7600 _____ **12**

Looking for pricing, stock, or lifecycle information?

Click below to explore more details on WIN SOURCE:

-  [View MAX4951CCTP+T on WIN SOURCE](#)
-  [Maxim Integrated Information](#)

Optimize Your Supply Chain with WIN SOURCE Solutions

-  Global Sourcing Solution
-  Obsolete Management
-  Cost Control Management
-  Shortage Management
-  Alternative Solution
-  Excess Inventory Management