



**THE DATASHEET OF
MAX4915AELT+TG05**



MAX4914B/MAX4915A/B/ MAX4917A/B

100mA/200mA/300mA Current-Limit Switches with Low Shutdown Reverse Current

General Description

The MAX4914B/MAX4915A/B/MAX4917A/B family of switches feature internal current limiting to prevent damage to host devices due to faulty load conditions. These analog switches have a low 0.2Ω on-resistance and operate from a 2.3V to 5.5V input voltage range. They are available with guaranteed 100mA, 200mA, and 300mA current limits, making them ideal for SDIO and other load switching applications.

When the switch is on and a load is connected to the port, a guaranteed blanking time of 14ms ensures that the transient voltages settle down. If after this blanking time the load current is greater than the current limit, the MAX4914B/MAX4915B/MAX4917B latching versions enter a latching state where the switch is turned off and $\overline{\text{FLAG}}$ is issued to the microprocessor. The switch can be turned on again by cycling the power or the ON pin.

The MAX4915A/MAX4917A have an autoretry feature where the switch turns off after the blanking time and then continuously checks to see if the overload condition is present. The switch turns on and remains on after the overload condition disappears and $\overline{\text{FLAG}}$ deasserts.

The MAX4914B is available in the tiny 6-pin μDFN (2mm x 2mm) package, while the MAX4915A/B and MAX4917A/B are available in both 6-pin μDFN (2mm x 2mm) and space-saving 5-pin SOT23 packages. These devices operate over the -40°C to +85°C extended temperature range.

Typical Operating Circuit appear at end of data sheet. end of data sheet.

Benefits and Features

- Guaranteed Current Limit: 100mA, 200mA, 300mA
- Thermal-Shutdown Protection
- Reverse Current Protection
- 0.2Ω On-Resistance
- 14ms Guaranteed Blanking Time
- $\overline{\text{FLAG}}$ Function
- 80μA Supply Current
- 8μA Latchoff Current (MAX4914B/MAX4915B/MAX4917B)
- Autoretry (MAX4915A/MAX4917A)
- 0.01μA Shutdown Current
- 2.3V to 5.5V Supply Range
- Undervoltage Lockout
- Fast Current-Limit Response Time (5μs)
- Low (0.1μA typ) Reverse Shutdown Current
- Tiny 6-Pin μDFN (2mm x 2mm) and 5-Pin SOT23 Packages

Applications

- PDAs and Palmtop Devices
- Cell Phones
- GPS Systems
- Handheld Devices
- SDIO
- USB Ports
- Notebook Computers

MAX4914B/MAX4915A/B/
MAX4917A/B

100mA/200mA/300mA Current-Limit Switches
with Low Shutdown Reverse Current

Absolute Maximum Ratings

IN, ON, $\overline{\text{FLAG}}$, OUT to GND-0.3V to +6V
 OUT Short Circuit to GNDInternally Limited
 Continuous Power Dissipation ($T_A = +70^\circ\text{C}$)
 5-Pin SOT23 (derate 7.1mW/ $^\circ\text{C}$ above +70 $^\circ\text{C}$)571mW
 6-Pin μDFN (derate 4.5mW/ $^\circ\text{C}$ above +70 $^\circ\text{C}$)358mW

Operating Temperature Range..... -40 $^\circ\text{C}$ to +85 $^\circ\text{C}$
 Junction Temperature..... +150 $^\circ\text{C}$
 Storage Temperature Range..... -65 $^\circ\text{C}$ to +150 $^\circ\text{C}$
 Lead Temperature (soldering, 10s)+300 $^\circ\text{C}$

Stresses beyond those listed under "Absolute Maximum Ratings" may cause permanent damage to the device. These are stress ratings only, and functional operation of the device at these or any other conditions beyond those indicated in the operational sections of the specifications is not implied. Exposure to absolute maximum rating conditions for extended periods may affect device reliability.

Electrical Characteristics

($V_{\text{IN}} = +2.3\text{V}$ to +5.5V, $T_A = -40^\circ\text{C}$ to +85 $^\circ\text{C}$, unless otherwise noted. Typical values are at $V_{\text{IN}} = +3.3\text{V}$, $T_A = +25^\circ\text{C}$.) (Note 1)

PARAMETER	SYMBOL	CONDITIONS	MIN	TYP	MAX	UNITS
Operating Voltage	V_{IN}		2.3		5.5	V
Quiescent Current	I_{Q}	$V_{\text{ON}} = V_{\text{IN}}$, $I_{\text{OUT}} = 0$, switch on	$V_{\text{IN}} = +2.3\text{V}$ to +5.0V	80	120	μA
			$V_{\text{IN}} = +5.0\text{V}$ to +5.5V		160	
Latchoff Current (Note 2)	I_{LATCH}	$V_{\text{ON}} = V_{\text{IN}}$, after an overcurrent fault MAX4914B/MAX4915B/MAX4917B (latchoff versions)		8	17	μA
Forward Shutdown Current	I_{SHDN}	$V_{\text{ON}} = 0$, $V_{\text{OUT}} = 0$, $V_{\text{IN}} = +5.5\text{V}$		0.01	1	μA
Reverse Shutdown Current	I_{SHDN}	$V_{\text{ON}} = 0$, $V_{\text{OUT}} = +5.5\text{V}$, $V_{\text{IN}} = +2.3\text{V}$		0.01	1	μA
Forward Current Limit	I_{FWD}	MAX4914B, $V_{\text{OUT}} = \text{GND}$	100		150	mA
		MAX4915_, $V_{\text{OUT}} = \text{GND}$	200		300	
		MAX4917_, $V_{\text{OUT}} = \text{GND}$	300		450	
Reverse Current Limit	I_{REV}	MAX4914B, $V_{\text{OUT}} - V_{\text{IN}} \geq 0.5\text{V}$			150	mA
		MAX4915_, $V_{\text{OUT}} - V_{\text{IN}} \geq 0.5\text{V}$			300	
		MAX4917_, $V_{\text{OUT}} - V_{\text{IN}} \geq 0.5\text{V}$			450	
ON Input Leakage		$V_{\text{ON}} = V_{\text{IN}}$ or GND	-1		+1	μA
Undervoltage Lockout	UVLO	Rising edge	1.75		2.25	V
Undervoltage-Lockout Hysteresis				100		mV
On-Resistance	R_{ON}	$T_A = +25^\circ\text{C}$, $I_{\text{OUT}} = 95\text{mA}$		0.2	0.4	Ω
		$T_A = -40^\circ\text{C}$ to +85 $^\circ\text{C}$, $I_{\text{OUT}} = 95\text{mA}$			0.5	
ON Input Logic-High Voltage	V_{IH}	MAX4914B/MAX4915B/MAX4917B	2.0			V
		MAX4915A/MAX4917A	1.4			
ON Input Logic-Low Voltage	V_{IL}	MAX4914B/MAX4915B/MAX4917B			0.8	V
		MAX4915A/MAX4917A			0.4	
$\overline{\text{FLAG}}$ Output Logic-Low Voltage		$I_{\text{SINK}} = 1\text{mA}$			0.4	V
$\overline{\text{FLAG}}$ Output-High Leakage Current		$V_{\text{ON}} = V_{\text{IN}} = V_{\overline{\text{FLAG}}} = +5.5\text{V}$			1	μA
Thermal Shutdown				+150		$^\circ\text{C}$
Thermal-Shutdown Hysteresis				15		$^\circ\text{C}$

Electrical Characteristics (continued)

($V_{IN} = +2.3V$ to $+5.5V$, $T_A = -40^{\circ}C$ to $+85^{\circ}C$, unless otherwise noted. Typical values are at $V_{IN} = +3.3V$, $T_A = +25^{\circ}C$.) (Note 1)

PARAMETER	SYMBOL	CONDITIONS	MIN	TYP	MAX	UNITS
DYNAMIC CHARACTERISTICS						
Turn-On Time		V_{ON} from low to high; $I_{OUT} = 10mA$, $C_L = 0.1\mu F$ (Note 3)		100		μs
Turn-Off Time		V_{ON} from high to low; $I_{OUT} = 10mA$, $C_L = 0.1\mu F$ (Note 3)		40		ns
Blanking Time	t_{BLANK}	Overcurrent fault (Figures 2, 3)	14		60	ms
Short-Circuit Current-Limit Response Time		$V_{ON} = V_{IN} = +3.3V$, short circuit applied to OUT		5		μs
Retry Time (Note 4)	t_{RETRY}	MAX4915A/MAX4917A (autoretry versions) (Figure 2) (Note 4)	210		900	ms

Note 1: All parts are 100% tested at $+25^{\circ}C$. Limits across the full temperature range are guaranteed by design and correlation.

Note 2: Latchoff current does not include the current flowing into \overline{FLAG} .

Note 3: The on-time is defined as the time taken for the current through the switch to go from 0mA to 10mA. The off-time is defined as the time taken for the current through the switch to go from 10mA to 0mA.

Note 4: Retry time is typically 15 times the blanking time.

Typical Operating Characteristics

($V_{IN} = 3.3V$, $T_A = +25^{\circ}C$, unless otherwise noted.)

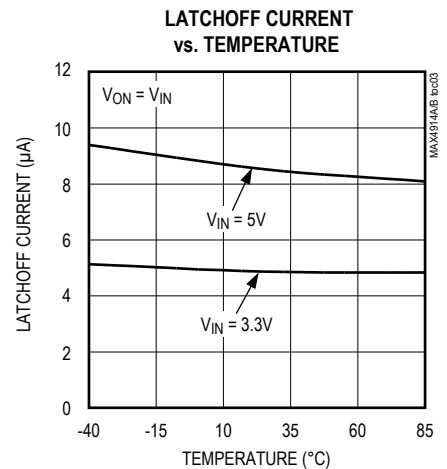
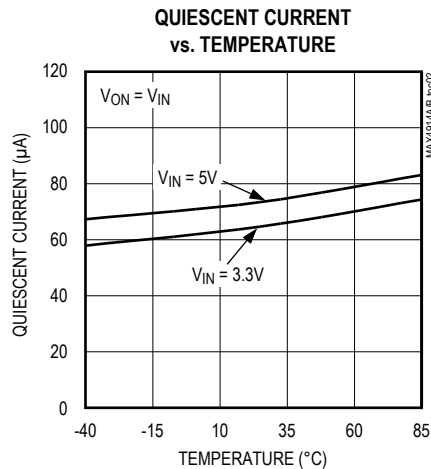
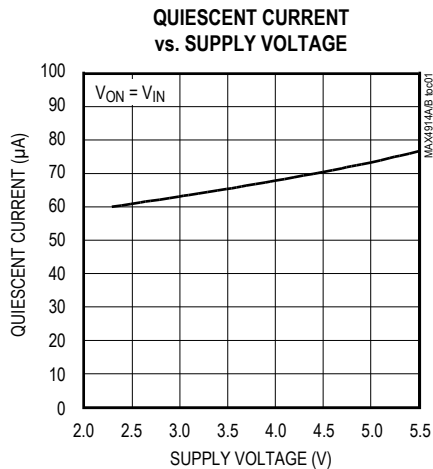

Typical Operating Characteristics (continued)

($V_{IN} = 3.3V$, $T_A = +25^\circ C$, unless otherwise noted.)

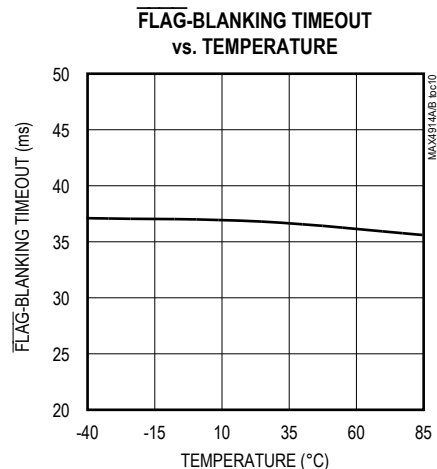
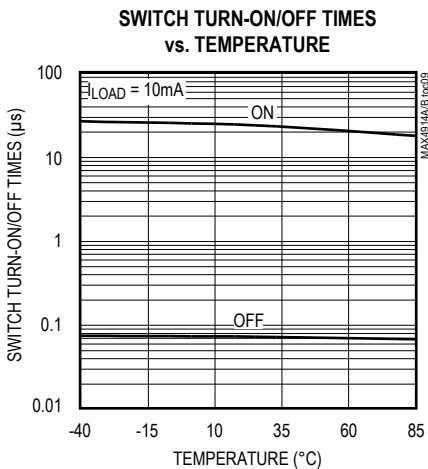
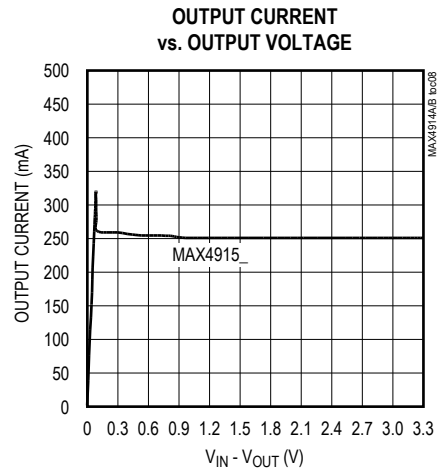
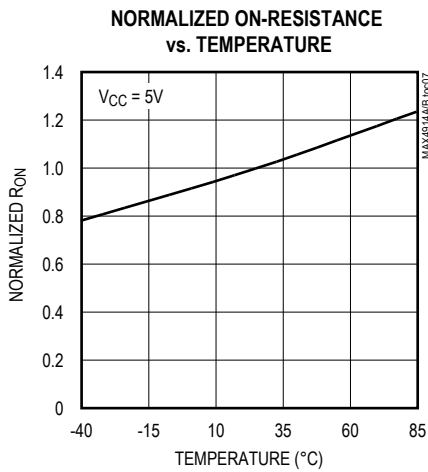
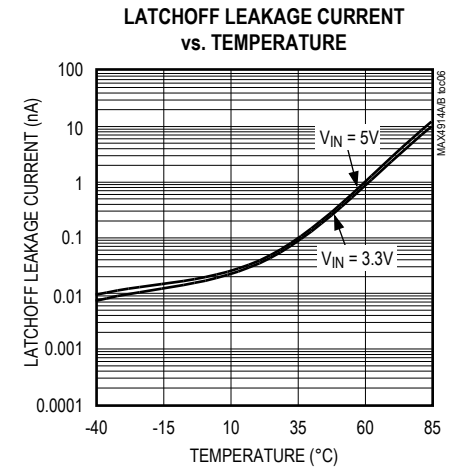
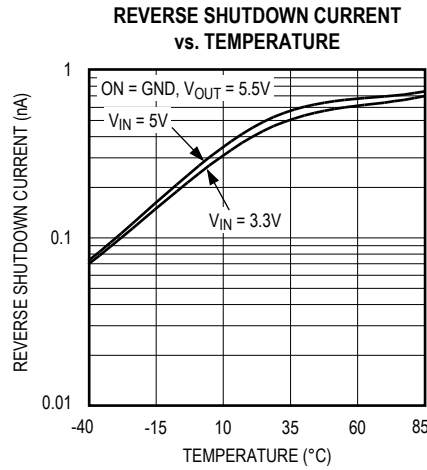
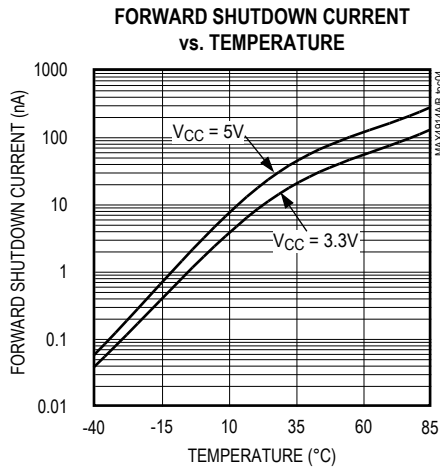

Typical Operating Characteristics (continued)

($V_{IN} = 3.3V$, $T_A = +25^\circ C$, unless otherwise noted.)

CURRENT-LIMIT RESPONSE (V_{ON} RISING)

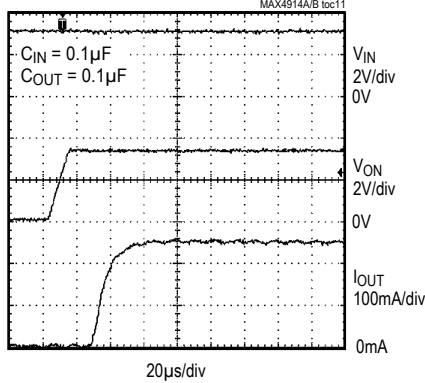

CURRENT-LIMIT RESPONSE
(V_{IN} AND V_{ON} RISING TOGETHER)

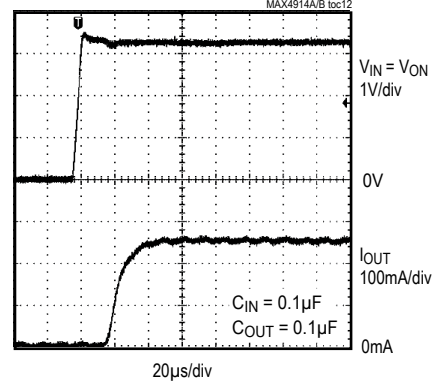

CURRENT-LIMIT RESPONSE
(OUT SHORTED TO GND)

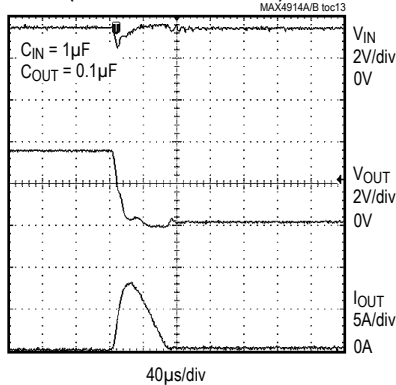

TURN-ON RESPONSE

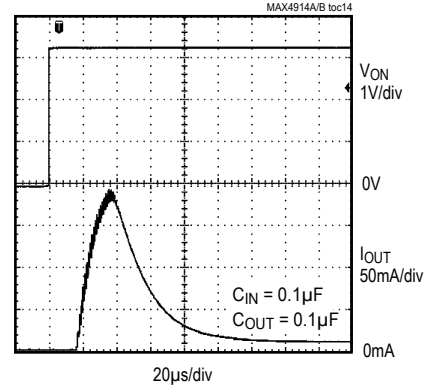

TURN-OFF RESPONSE

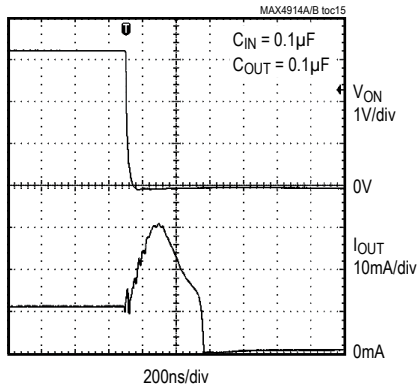

FLAG-BLANKING RESPONSE

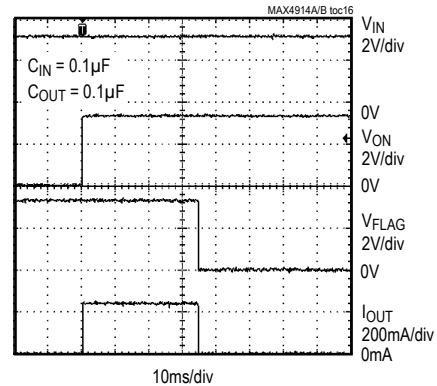

MAX4914B/MAX4915A/B/
MAX4917A/B

100mA/200mA/300mA Current-Limit Switches
with Low Shutdown Reverse Current

Pin Configurations

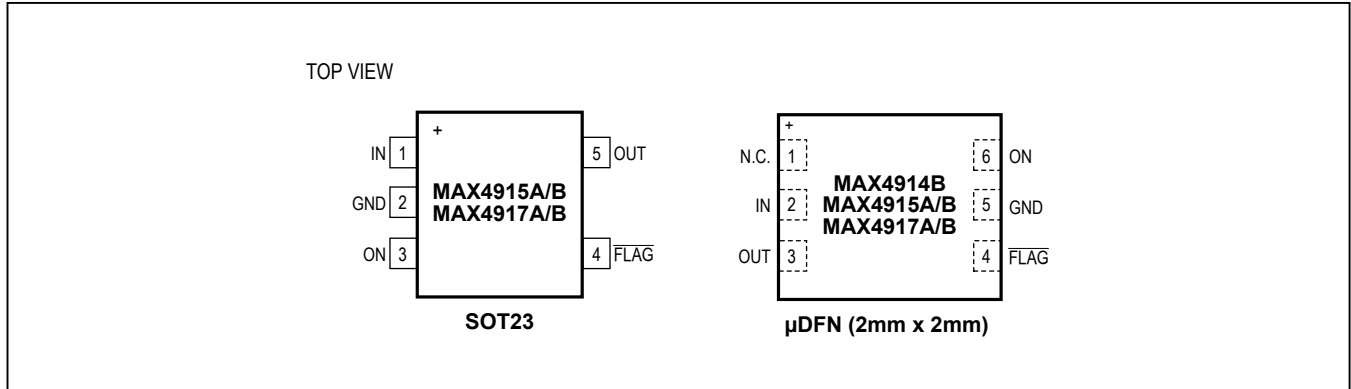

Pin Description

PIN		NAME	FUNCTION
MAX4915A/B/ MAX4917A/B (SOT23)	MAX4914A/B/ MAX4915A/B/ MAX4917A/B (μDFN)		
1	2	IN	Input. Bypass with a 0.1μF ceramic capacitor to ground as close to the device as possible.
2	5	GND	Ground
3	6	ON	Active-High, Switch-On Input. A logic-high turns the switch on.
4	4	FLAG	Fault Output. This open-drain output goes low when the device stays in forward or reverse current limit for more than the blanking time period. FLAG is high impedance when a fault is not present or when ON is low.
5	3	OUT	Switch Output. Bypass with a 0.1μF ceramic capacitor to ground as close to the device as possible.
—	1	N.C.	No Connection. Not internally connected.

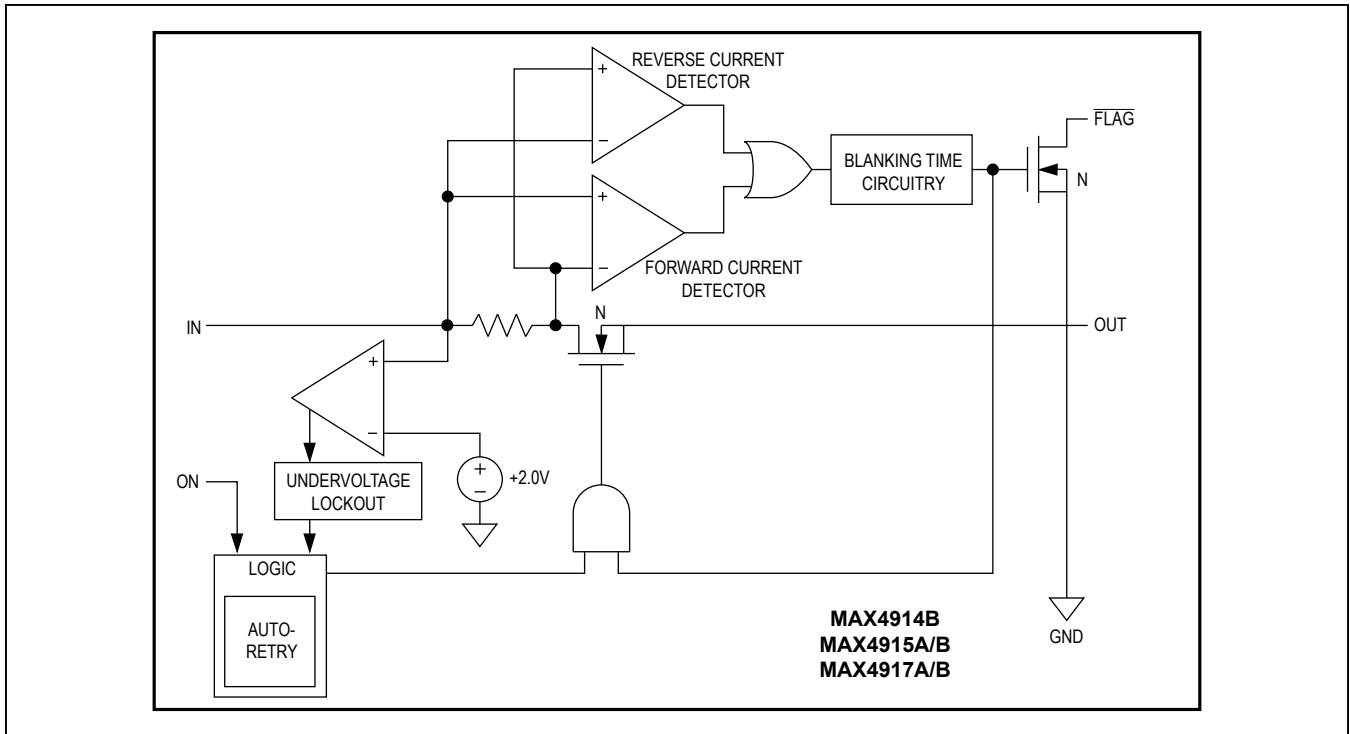

Figure 1. Functional Diagram

Detailed Description

The MAX4914B/MAX4915A/B/MAX4917A/B are forward/reverse current-limited switches that operate from a +2.3V to +5.5V input voltage range and guarantee a 100mA, 200mA, and 300mA minimum current-limit threshold for different options. The voltage drop across an internal sense resistor is compared to two reference voltages to indicate a forward or reverse current-limit fault. When the load current exceeds the preset current limit for greater than the fault-blanking time, the switch opens and $\overline{\text{FLAG}}$ asserts.

The MAX4915A/MAX4917A have an autoretry function that turns on the switch again after an internal retry time expires. If the faulty load condition is still present after the blanking time, the switch turns off again and the cycle is repeated. If the faulty load condition is not present, the switch remains on. During this retry time, $\overline{\text{FLAG}}$ remains low until the fault is removed.

The MAX4914B/MAX4915B/MAX4917B do not have the autoretry option, and the switch remains in latching mode until the ON pin or the input power is cycled from high to low and then high again.

The undervoltage-lockout (UVLO) circuit prevents erroneous switch operation when the input voltage goes too low.

Reverse Current Protection

All devices limit the reverse current (V_{OUT} to V_{IN}) from exceeding the maximum I_{REV} value. The switch is shut off and $\overline{\text{FLAG}}$ is asserted if the reverse current-limit condition persists for more than the blanking time. This feature prevents excessive reverse currents from flowing through the device to the source. When the device is in shutdown ($V_{\text{ON}} < V_{\text{IL}}$), the current from OUT to IN does not exceed 1 μA (max).

Switch-On/Off Control

Toggle ON high to enable the current-limited switches. The switches are continuously on only if V_{IN} exceeds the UVLO threshold (typically 2V) and there is no fault. When a forward/reverse current fault is present or the die exceeds the thermal-shutdown temperature of +150°C, OUT is internally disconnected from IN and the supply current decreases to 8 μA (latchoff). The switch is now operating in one of its off states. The switch-off state also occurs when driving ON low, thus reducing the supply current (shutdown) to 0.01 μA (typ). [Table 1](#) illustrates the ON/OFF state.

Table 1. MAX4914B/MAX4915A/B/MAX4917A/B Switch Truth Table

ON	FAULT	SWITCH ON/OFF	SUPPLY CURRENT MODE
Low	X	OFF	Shutdown
High	Undervoltage lockout	OFF	Shutdown
High	Thermal	OFF immediately (t_{BLANK} period does not apply)	Latchoff
High	Current limit	OFF after t_{BLANK} period has elapsed	Latchoff
		ON during t_{BLANK} period, OFF during t_{RETRY} period for the MAX4915A/MAX4917A (autoretry versions); cycle repeats until fault is removed	See the <i>Autoretry</i> (MAX4915A/MAX4917A) section

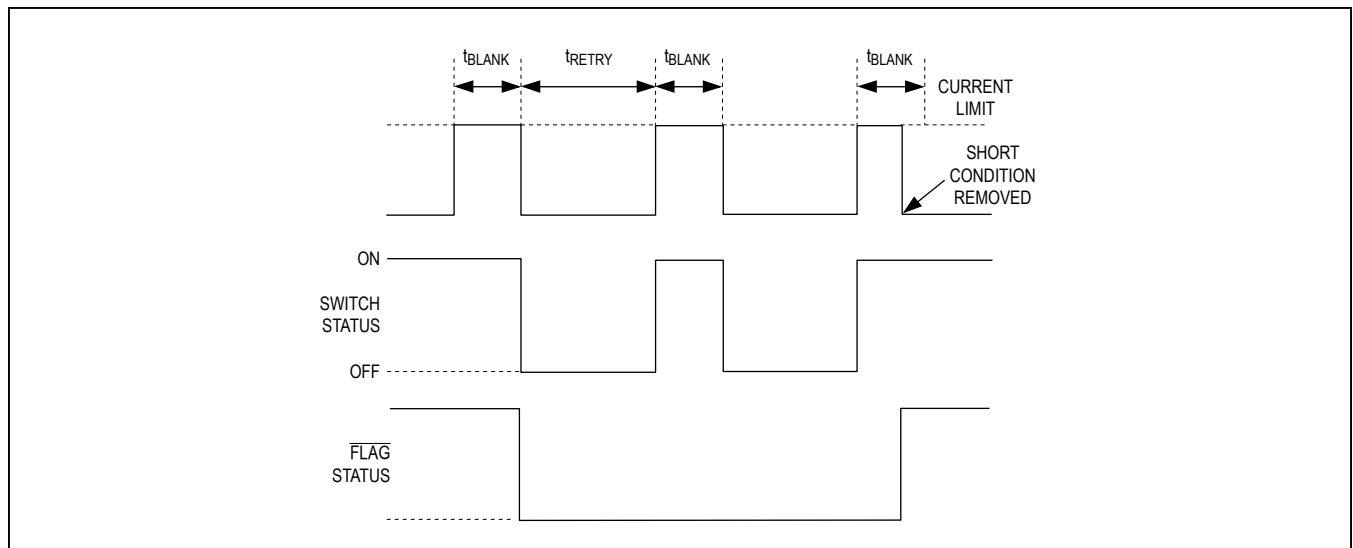

Figure 2. MAX4915A/MAX4917A Autoretry Fault-Blanking Diagram

FLAG Indicator

All devices feature a latched fault output, \overline{FLAG} . Whenever a fault is activated, it latches the \overline{FLAG} output low and also turns the switch off. \overline{FLAG} is an open-drain output transistor and requires an external pullup resistor from \overline{FLAG} to IN. During shutdown ($V_{ON} < V_{IL}$), the pulldown on the \overline{FLAG} output is released in order to limit power dissipation. \overline{FLAG} goes low when any of the following conditions occur:

- The die temperature exceeds the thermal-shutdown temperature limit of +150°C.
- The device is in current limit for more than the fault-blanking period.
- V_{IN} is below the UVLO threshold.

For the MAX4915A/MAX4917A (autoretry versions), \overline{FLAG} stays low until the overcurrent condition is removed (See [Figure 2](#)).

Autoretry (MAX4915A/MAX4917A)

When the forward or reverse current-limit threshold is exceeded, t_{BLANK} timer begins counting ([Figure 2](#)). The timer resets if the overcurrent condition disappears before t_{BLANK} has elapsed. A retry time delay, t_{RETRY} , is started immediately after t_{BLANK} has elapsed, and during that time, the switch is latched off. At the end of t_{RETRY} , the switch is turned on again. If the fault still exists, the cycle is repeated. If the fault has been removed, the switch stays on.

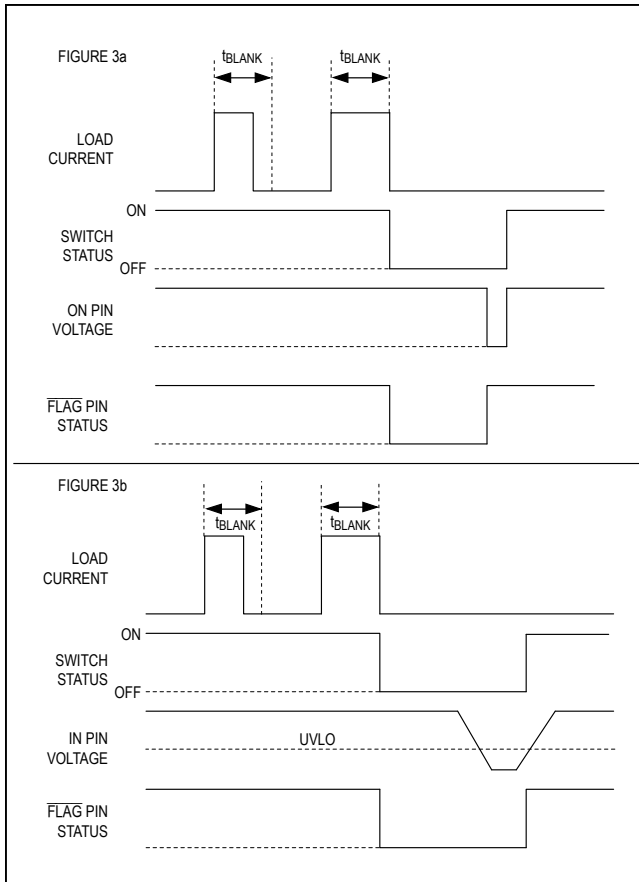

Figure 3. MAX4914B/MAX4915B/MAX4917B Latchoff Fault Blanking

The autoretry feature saves system power in the case of an overcurrent or short-circuit condition. During t_{BLANK} , when the switch is on, the supply current is at the current limit. During t_{RETRY} , when the switch is off, the current through the switch is zero. Instead of observing the full load current, the switch sees the equivalent load current times duty cycle or $I_{SUPPLY} = I_{LOAD} \times t_{BLANK} / (t_{BLANK} + t_{RETRY})$. With a typical $t_{BLANK} = 37\text{ms}$ and typical $t_{RETRY} = 555\text{ms}$, the duty cycle is 6%, which results in a 94% power savings over the switch being on the entire time. The duty cycle is consistent across the process and devices.

Latchoff (MAX4914B/MAX4915B/MAX4917B)

When the forward or reverse current-limit threshold is exceeded, the t_{BLANK} timer begins counting. The timer resets if the overcurrent condition disappears before t_{BLANK} has elapsed. The switch is shut off if the overcurrent condition continues up to the end of the blanking time.

Reset the switch by either toggling ON (Figure 3a) or cycling the input voltage below UVLO, typically 2V (Figure 3b).

Fault Blanking

All devices feature 14ms (min) fault blanking. Fault blanking allows current-limit faults, including momentary short-circuit faults that occur when hot-swapping a capacitive load, and also ensures that no fault is issued during power-up. When a load transient causes the device to enter current limit, an internal counter starts. If the load-transient fault persists beyond the fault-blanking timeout, \overline{FLAG} asserts low. Load-transient faults less than t_{BLANK} do not cause a \overline{FLAG} output assertion. Only current-limit faults are blanked.

A thermal fault and input voltage drops below the UVLO threshold cause \overline{FLAG} to assert immediately and not wait for the blanking time.

Thermal Shutdown

The devices have a thermal-shutdown feature to protect the devices from overheating. The switch turns off and \overline{FLAG} goes low immediately (no fault blanking) when the junction temperature exceeds $+150^\circ\text{C}$. The switch turns back on when the device temperature drops approximately by 15°C .

Applications Information

Input Capacitor

To limit the input-voltage drop during momentary output short-circuit conditions, connect a capacitor from IN to GND. A $0.1\mu\text{F}$ ceramic capacitor is adequate for most applications; however, higher capacitor values further reduce the voltage drop at the input and are recommended for lower voltage applications.

Output Capacitance

Connect a $0.1\mu\text{F}$ capacitor from OUT to GND. This capacitor helps prevent inductive parasitics from pulling OUT negative during turn-off, thus preventing the devices from tripping erroneously. If the load capacitance is too large, the current may not have enough time to charge the capacitance and the device assumes that there is a faulty load condition. The maximum capacitive load value that can be driven from OUT is obtained by the following formula:

$$C_{MAX} < \frac{I_{FWD_MIN} \times t_{BLANK_MIN}}{V_{IN}}$$

Layout and Thermal Dissipation

To optimize the switch response time to output short-circuit conditions, it is very important to keep all traces as short as possible to reduce the effect of undesirable parasitic inductance. Place input and output capacitors as close as possible to the device (no more than 5mm). IN and OUT pins must be connected with short traces to the power bus.

During normal operation, the power dissipation is small and the package temperature change is minimal. If the output is continuously shorted to ground at the maximum supply voltage, the operation of the switches with the autoretry option does not cause problems because the

total power dissipated during the short is scaled by the duty cycle:

$$P_{MAX} = \frac{V_{IN_MAX} \times I_{OUT_MAX} \times t_{BLANK}}{t_{RETRY} + t_{BLANK}} = 155mW$$

where $V_{IN} = 5.5V$, $I_{OUT} = 450mA$, $t_{BLANK} = 14ms$, and $t_{RETRY} = 210ms$.

Attention must be given to the MAX4914B/MAX4915B/MAX4917B (latchoff versions), where the latchoff condition must be manually reset by toggling ON from high to low. If the latchoff time duration is not sufficiently high, it is possible for the device to reach the thermalshutdown threshold and never be able to turn the device on until it cools down.

Typical Operating Circuit

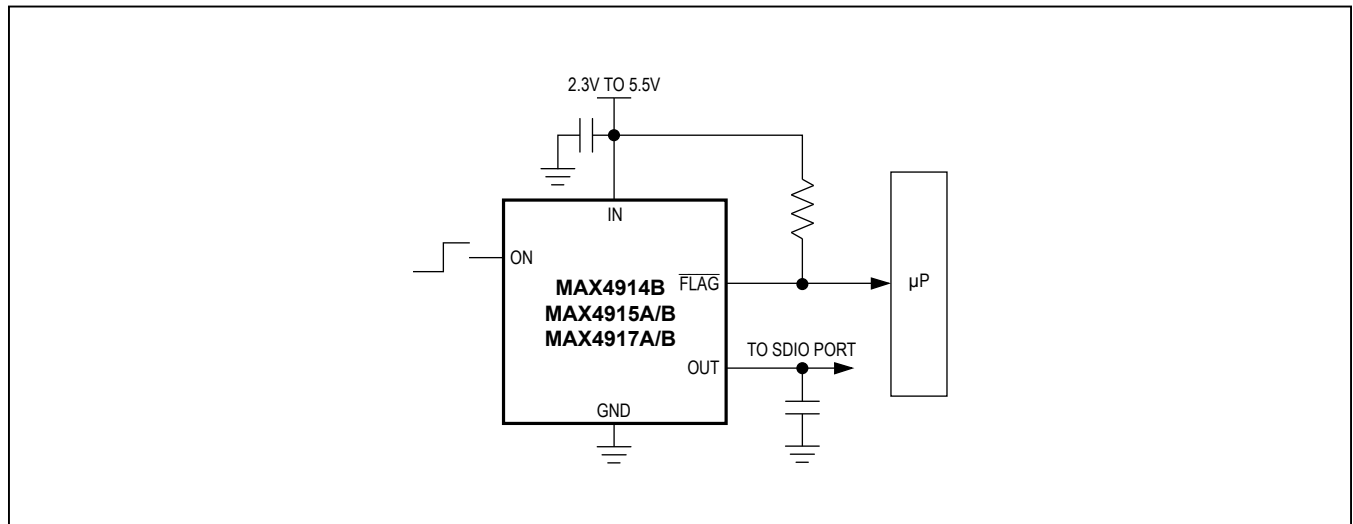

Ordering Information/Selector Guide

PART	PIN-PACKAGE	TOP MARK	CURRENT LIMIT (mA)	RETRY/LATCHOFF
MAX4914BELT+T	6 μ DFN	ABF	100	Latchoff
MAX4915AELT+T	6 μ DFN	ABL	200	Autoretry
MAX4915AEUK+T	5 SOT23	AEYN	200	Autoretry
MAX4915BELT+T	6 μ DFN	ABG	200	Latchoff
MAX4915BEUK+T	5 SOT23	AEYK	200	Latchoff
MAX4917AELT+T	6 μ DFN	ABN	300	Autoretry
MAX4917AEUK+T	5 SOT23	AEYP	300	Autoretry
MAX4917BELT+T	6 μ DFN	ABI	300	Latchoff
MAX4917BEUK+T	5 SOT23	AEYM	300	Latchoff

Note: All devices are specified over the -40°C to $+85^{\circ}\text{C}$ operating temperature range.

+Denotes a lead-free/RoHS-compliant package.

T = Tape-and-reel package.

Package Information

For the latest package outline information and land patterns (footprints), go to www.maximintegrated.com/packages. Note that a "+", "#", or "." in the package code indicates RoHS status only. Package drawings may show a different suffix character, but the drawing pertains to the package regardless of RoHS status.

PACKAGE TYPE	PACKAGE CODE	OUTLINE NO.
6 μ DFN	L622-1	21-0164
5 SOT23	U5+2	21-0057

Chip Information

PROCESS: BiCMOS

Revision History

REVISION NUMBER	REVISION DATE	DESCRIPTION	PAGES CHANGED
0	5/06	Initial release	—
1	12/06	Removed future product notes. Added new V_{IH} and V_{IL} EC table specs for the MAX4915	—
2	6/08	Changed V_{IH} and V_{IL} EC table specs for the MAX4917A	2
3	1/16	Updated future product designations and package code	1, 10

For pricing, delivery, and ordering information, please contact Maxim Direct at 1-888-629-4642, or visit Maxim Integrated's website at www.maximintegrated.com.

Maxim Integrated cannot assume responsibility for use of any circuitry other than circuitry entirely embodied in a Maxim Integrated product. No circuit patent licenses are implied. Maxim Integrated reserves the right to change the circuitry and specifications without notice at any time. The parametric values (min and max limits) shown in the Electrical Characteristics table are guaranteed. Other parametric values quoted in this data sheet are provided for guidance.

Looking for pricing, stock, or lifecycle information?

Click below to explore more details on WIN SOURCE:

- ⊖ [View MAX4915AELT+TG05 on WIN SOURCE](#)
- ⊖ [Maxim Integrated Information](#)

Optimize Your Supply Chain with WIN SOURCE Solutions

- ✓ Global Sourcing Solution
- ✓ Obsolete Management
- ✓ Cost Control Management
- ✓ Shortage Management
- ✓ Alternative Solution
- ✓ Excess Inventory Management