



**THE DATASHEET OF  
MAX4831ELT+T**



## MAX4826–MAX4831

## 50mA/100mA Current-Limit Switches with NO-LOAD Flag in $\mu$ DFN

### General Description

The MAX4826–MAX4831 family of switches has internal current limiting to prevent host devices from being damaged due to faulty load conditions. These analog switches have a low  $0.7\Omega$  on-resistance and operate from a +2.3V to +5.5V input voltage range. These devices are available with guaranteed 50mA and 100mA current limits, making them ideal for load-switching applications. In addition to the current-limit fault flag (F $\overline{\text{FLG}}$ ), an open-drain no-load flag indicator (NOLD) notifies the system when the current through the switch is less than 10mA (MAX4826–MAX4829), or 5mA (MAX4830/MAX4831).

When the switch is on and a load is connected to the port, a guaranteed blanking time of 14ms ensures that the transient voltages settle down. If, after this blanking time, the load current is greater than the current limit, the MAX4826/MAX4828/MAX4830 enter a latching state where the switch is turned off, and F $\overline{\text{FLG}}$  is issued to the microprocessor. The switch can be turned on again by cycling the power or ON.

The MAX4827/MAX4829/MAX4831 have an autoretry feature where the switch turns off after the blanking time, and then continuously checks to see if the overload condition is present. The current-limit fault flag (F $\overline{\text{FLG}}$ ) is issued and remains low until after the fault condition is removed. The switch remains on after the overload condition disappears.

The MAX4826–MAX4831 operate over the extended  $-40^{\circ}\text{C}$  to  $+85^{\circ}\text{C}$  temperature range, and are available in a tiny space-saving, 1mm x 1.5mm, 6-pin  $\mu$ DFN package.

### Features

- Guaranteed Current Limit: 50mA, 100mA
- Thermal Shutdown Protection
- Reverse-Current Protection
- $0.7\Omega$  On-Resistance (MAX4826–MAX4831)
- 14ms Guaranteed Blanking Time
- Fault Flag (F $\overline{\text{FLG}}$ )
- No-Load Flag (NOLD)
- 65 $\mu$ A Supply Current
- 8 $\mu$ A Latchoff Current
- 0.01 $\mu$ A Shutdown Current
- +2.3V to +5.5V Supply Range
- Undervoltage Lockout
- Fast Current-Limit Response Time
- 6-Pin  $\mu$ DFN Package (1mm x 1.5mm)

### Applications

- GPS Systems
- Cell Phones
- Digital Still Cameras
- PDAs and Palmtop Devices
- MP3 Players

[Pin Configuration](#) appears at end of data sheet.

[Ordering Information](#) appears at end of data sheet.

**Absolute Maximum Ratings**

IN, ON,  $\overline{\text{FLG}}$ ,  $\overline{\text{NOLD}}$ , OUT to GND .....-0.3V to +6V  
 OUT Short Circuit to GND.....Internally Limited  
 Continuous Power Dissipation ( $T_A = +70^\circ\text{C}$ )  
 6-Pin  $\mu$ DFN (derate 2.1mW/ $^\circ\text{C}$  above +70 $^\circ\text{C}$ ) ..... 168mW  
 Operating Temperature Range..... -40 $^\circ\text{C}$  to +85 $^\circ\text{C}$

Junction Temperature..... +150 $^\circ\text{C}$   
 Storage Temperature Range..... -65 $^\circ\text{C}$  to +150 $^\circ\text{C}$   
 Lead Temperature (soldering, 10s) ..... +300 $^\circ\text{C}$

*Stresses beyond those listed under "Absolute Maximum Ratings" may cause permanent damage to the device. These are stress ratings only, and functional operation of the device at these or any other conditions beyond those indicated in the operational sections of the specifications is not implied. Exposure to absolute maximum rating conditions for extended periods may affect device reliability.*

**Package Information**

<b>PACKAGE TYPE: 6 <math>\mu</math>DFN</b>	
Package Code	L611+1
Outline Number	<u>21-0147</u>

For the latest package outline information and land patterns (footprints), go to [www.maximintegrated.com/packages](http://www.maximintegrated.com/packages). Note that a "+", "#", or "-" in the package code indicates RoHS status only. Package drawings may show a different suffix character, but the drawing pertains to the package regardless of RoHS status.

**Electrical Characteristics**

( $V_{IN} = +2.3\text{V}$  to +5.5V,  $T_A = -40^\circ\text{C}$  to +85 $^\circ\text{C}$ , unless otherwise noted. Typical values are at  $V_{IN} = +3.3\text{V}$ ,  $T_A = +25^\circ\text{C}$ .) (Note 1)

PARAMETER	SYMBOL	CONDITIONS	MIN	TYP	MAX	UNITS
Operating Voltage	$V_{IN}$		2.3		5.5	V
Quiescent Current	$I_Q$	$V_{ON} = V_{IN}$ , $I_{OUT} = 0$ , switch on	$V_{IN} = +2.3\text{V}$ to +5.0V	65	100	$\mu\text{A}$
			$V_{IN} = +5.0\text{V}$ to +5.5V		120	
Latchoff Current (Note 2)	$I_{LATCH}$	$V_{ON} = V_{IN} = 3.3\text{V}$ , after an overcurrent fault (MAX4826/MAX4828/MAX4830)		8	15	$\mu\text{A}$
Shutdown Current	$I_{SHDN}$	$V_{ON} = 0$ , $I_{OUT} = 0\text{mA}$		0.01	1	$\mu\text{A}$
Shutdown Reverse Leakage	$I_{SHDNRV}$	$V_{ON} = 0$ , $V_{IN} = +2.3\text{V}$ , $V_{OUT} = +5.5\text{V}$ (MAX4826/MAX4827/MAX4830/MAX4831)		0.01	1	$\mu\text{A}$
Forward-Current Limit	$I_{FWD}$	$R_L = 10\Omega$	50		120	mA
		(MAX4828/MAX4829) $R_L = 5\Omega$	100		240	
Reverse-Current Limit	$I_{REV}$	$V_{OUT} - V_{IN} < 0.5\text{V}$ (MAX4826/MAX4827/MAX4830/MAX4831)			120	mA
		$V_{OUT} - V_{IN} < 0.5\text{V}$ (MAX4828/MAX4829)			240	
No-Load Threshold	$I_{NLTH}$	MAX4826–MAX4829	1.0		10.0	mA
		MAX4830/MAX4831	0.5		5.0	
ON Input Leakage	$I_{ONLK}$	$V_{ON} = V_{IN}$ or GND	-1		+1	$\mu\text{A}$
Off-Switch Leakage	$I_{SWLK}$	$V_{IN} = +5.5\text{V}$ , $V_{ON} = 0$ , $V_{OUT} = 0$		0.01	1	$\mu\text{A}$
Undervoltage Lockout	UVLO	Rising edge	1.8		2.2	V
Undervoltage Lockout Hysteresis	UVLO <sub>HYS</sub>			100		mV
On-Resistance	$R_{ON}$	$T_A = +25^\circ\text{C}$ , $I_{OUT} = 20\text{mA}$	(MAX4826–MAX4829)	0.7	1.0	$\Omega$
			(MAX4830/MAX4831)	1.4	2.0	
		$T_A = -40^\circ\text{C}$ to +85 $^\circ\text{C}$ , $I_{OUT} = 20\text{mA}$	(MAX4826–MAX4829)		1.3	
			(MAX4830/MAX4831)		2.6	
ON Input-Logic-High Voltage	$V_{IH}$		2.0			V

**Electrical Characteristics (continued)**

( $V_{IN} = +2.3V$  to  $+5.5V$ ,  $T_A = -40^{\circ}C$  to  $+85^{\circ}C$ , unless otherwise noted. Typical values are at  $V_{IN} = +3.3V$ ,  $T_A = +25^{\circ}C$ .) (Note 1)

PARAMETER	SYMBOL	CONDITIONS	MIN	TYP	MAX	UNITS
ON Input-Logic-Low Voltage	$V_{IL}$				0.8	V
FFLG, NOLD Output-Logic-Low Voltage		$I_{SINK} = 1mA$			0.4	V
FFLG, NOLD Output-High Leakage Current		$V_{IN} = V_{FFLG} = V_{NOLD} = +5.5V$			1	$\mu A$
Thermal Shutdown				+150		$^{\circ}C$
Thermal-Shutdown Hysteresis				15		$^{\circ}C$
<b>DYNAMIC</b>						
Turn-On Time		ON from low to high; $I_{OUT} = 10mA$ , $C_L = 0.1\mu F$ (Note 3)		50		$\mu s$
Turn-Off Time		ON from high to low; $I_{OUT} = 10mA$ , $C_L = 0.1\mu F$ (Note 3)		30		ns
Blanking Time	$t_{BLANK}$	Overcurrent fault	14		60	ms
Short-Circuit Current-Limit Response Time		$V_{ON} = V_{IN} = +3.3V$ , short circuit applied to OUT		5		$\mu s$
No-Load-Detection Response Time		$I_{OUT}$ falling step signal from 15mA to 0mA, $C_L = 0.1\mu F$		60		$\mu s$
Retry Time	$t_{RETRY}$	Overcurrent fault (Figure 2) (Note 4)	196		840	ms

**Note 1:** All parts are 100% tested at  $T_A = +25^{\circ}C$ . Limits at  $T_A = -40^{\circ}C$  to  $+85^{\circ}C$  are guaranteed by design.

**Note 2:** Latchoff current does not include the current flowing into FFLG and NOLD.

**Note 3:** Turn-on time is defined as the time taken for the current through the switch to go from 0mA to full load. Turn-off time is defined as the time taken for the current through the switch to go from full load to 0mA.

**Note 4:** Retry time is typically 14x the blanking time.

**Typical Operating Characteristics**

( $V_{IN} = +3.3V$ ,  $T_A = +25^{\circ}C$ , unless otherwise noted.)

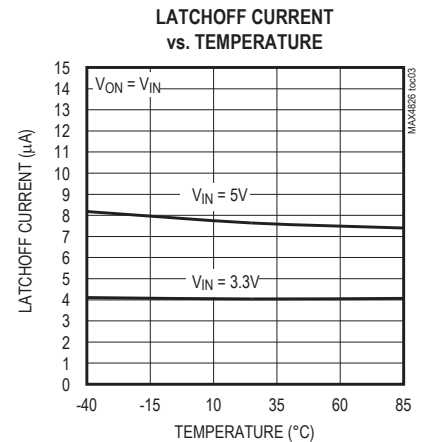
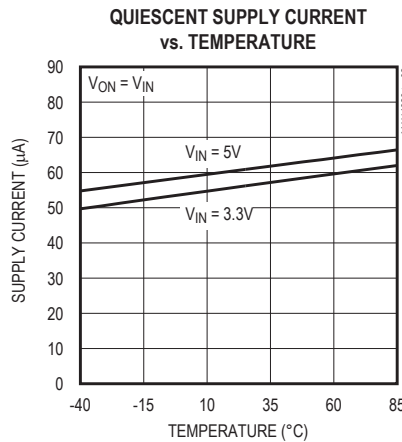
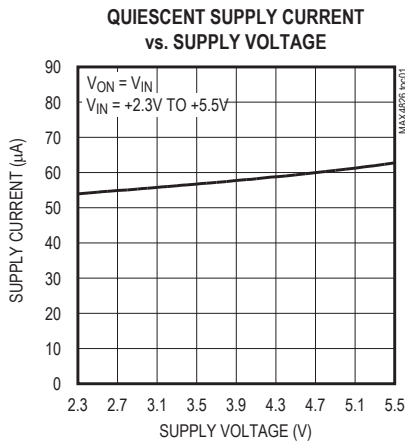

Typical Operating Characteristics (continued)

( $V_{IN} = +3.3V$ ,  $T_A = +25^\circ C$ , unless otherwise noted.)

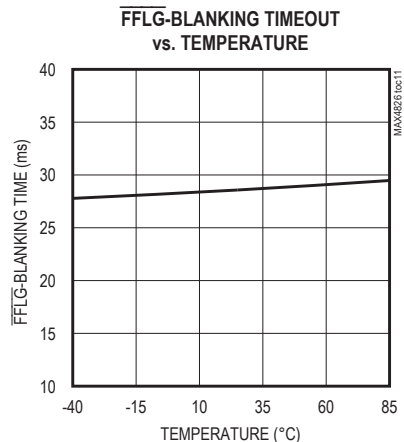
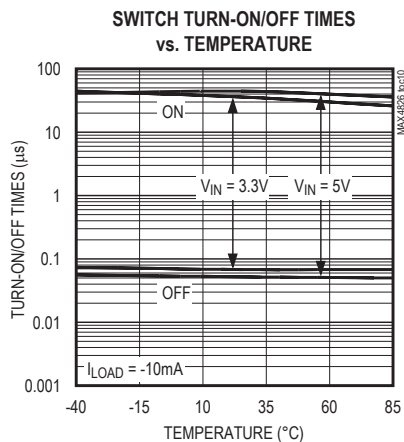
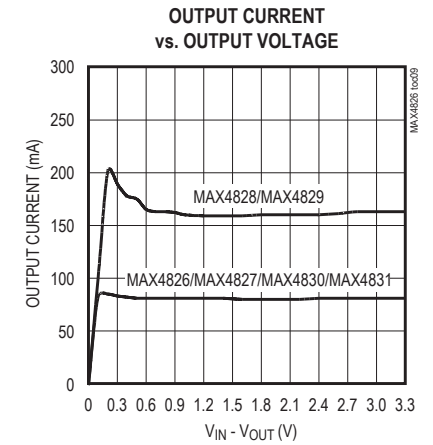
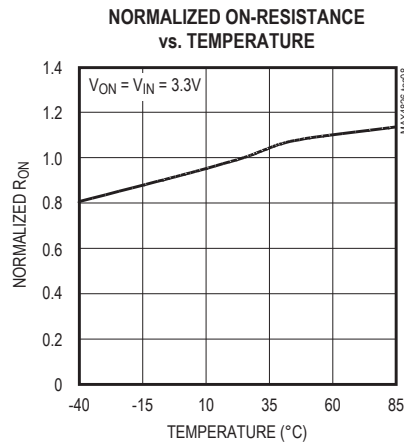
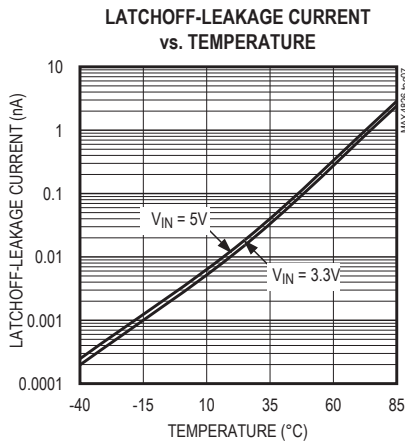
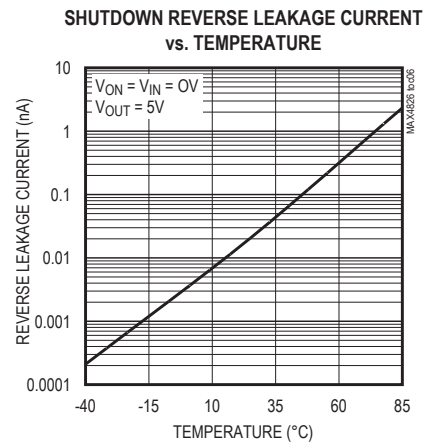
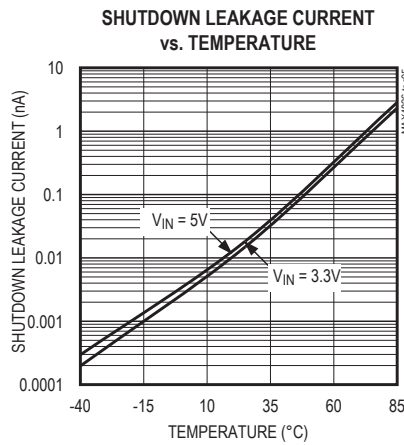
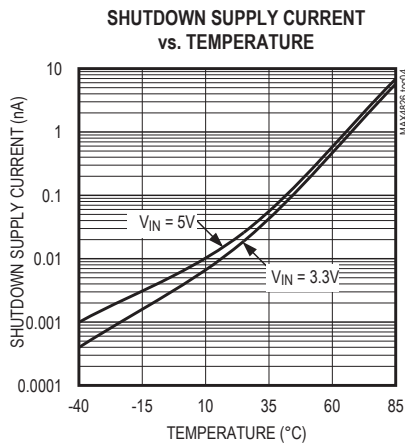

Typical Operating Characteristics (continued)

( $V_{IN} = +3.3V$ ,  $T_A = +25^\circ C$ , unless otherwise noted.)

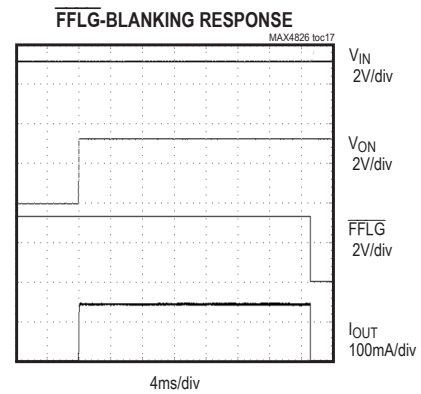
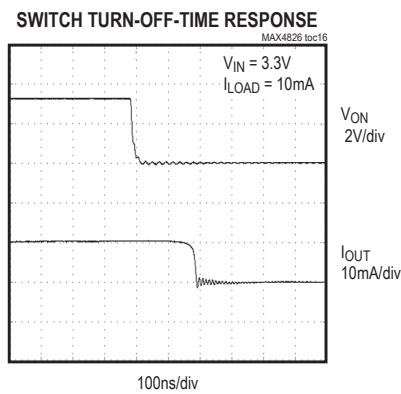
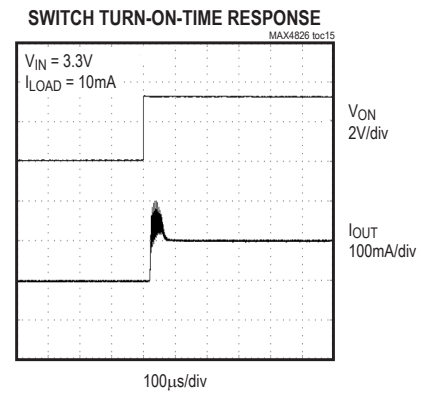
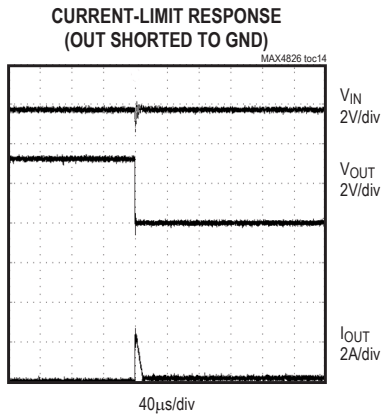
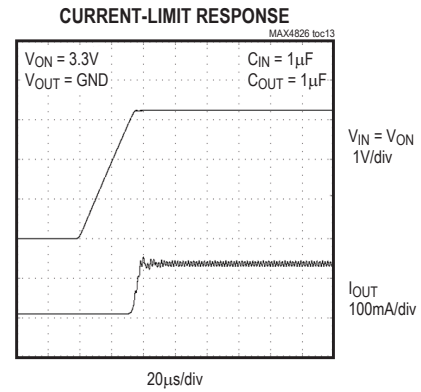
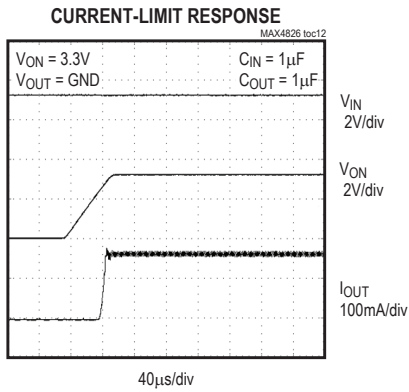

## Pin Description

PIN	NAME	FUNCTION
1	IN	Input. Bypass IN with a 0.1 $\mu$ F ceramic capacitor to ground.
2	GND	Ground
3	OUT	Switch Output. Bypass OUT with a 0.1 $\mu$ F capacitor to ground
4	$\overline{\text{FFLG}}$	Current-Limit Fault Output. $\overline{\text{FFLG}}$ is an open-drain output. $\overline{\text{FFLG}}$ goes low when the device stays in forward- or reverse-current limit for more than the blanking time period. $\overline{\text{FFLG}}$ is high impedance when a fault is not present or when ON is low.
5	$\overline{\text{NOLD}}$	No-Load Flag Output. $\overline{\text{NOLD}}$ is an open-drain output. $\overline{\text{NOLD}}$ goes low when a load of less than 10mA (MAX4826–MAX4829) or 5mA (MAX4830/MAX4831) is delivered to the output. $\overline{\text{NOLD}}$ is high impedance when a fault is not present or when ON is low.
6	ON	Active-High Switch-On Input. Drive ON high to turn the switch on.

## Detailed Description

The MAX4826–MAX4831 are forward-/reverse-current-limited switches that operate from a +2.3V to +5.5V input voltage range and guarantee a 50mA and 100mA minimum current-limit threshold for different options. The voltage drop across an internal sense resistor is compared to two reference voltages to indicate a forward- or reverse-current-limit fault. When the load current exceeds the preset current limit for greater than the fault-blanking time, the switch opens.

The MAX4827/MAX4829/MAX4831 have an autoretry function that turns on the switch again after an internal retry time expires. If the faulty load condition is still present after the blanking time, the switch turns off again and the cycle is repeated. If the faulty load condition is not present, the switch remains on.

The MAX4826/MAX4828/MAX4830 do not have the autoretry option, and the switch remains in latching mode until ON or the input power is cycled from high to low and then high again.

The undervoltage lockout (UVLO) circuit prevents erroneous switch operation when the input voltage goes too low during startup conditions.

## Reverse-Current Protection

The MAX4826–MAX4831 limit the reverse current ( $V_{\text{OUT}}$  to  $V_{\text{IN}}$ ) from exceeding the maximum  $I_{\text{REV}}$  value. The switch is shut off and  $\overline{\text{FFLG}}$  is asserted if the reverse-current-limit condition persists for more than the blanking time. This feature prevents excessive reverse currents from flowing through the device.

## Switch-On/Off Control

Toggle ON high to enable the current-limited switches. The switches are continuously on only if  $V_{\text{IN}}$  exceeds the UVLO threshold (typically 2V) and there is no fault. When a forward-/reverse-current fault is present or the die exceeds the thermal-shutdown temperature of +150°C, OUT is internally disconnected from IN, and the supply current decreases to 8 $\mu$ A (latchoff). The switch is now operating in one of its off states. The switch off state also occurs when driving ON low, thus reducing the supply current (shutdown) to 0.01 $\mu$ A. Table 1 illustrates the ON/OFF state of the MAX4826–MAX4831 current-limit switches.

**Table 1. MAX4826–MAX4831 Switch Truth Table**

ON	FAULT	SWITCH ON/OFF	SUPPLY CURRENT MODE
Low	X	OFF	Shutdown
High	Undervoltage lockout	OFF	Latchoff
High	Thermal	OFF immediately ( $t_{\text{BLANK}}$ period does not apply).	Latchoff
High	Current limit	OFF after $t_{\text{BLANK}}$ period has elapsed.	Latchoff
		ON during $t_{\text{BLANK}}$ period, OFF during $t_{\text{RETRY}}$ period for the MAX4827/MAX4829/MAX4831. Cycle repeats until fault is removed.	See the Autoretry (MAX4827/MAX4829/MAX4831) section

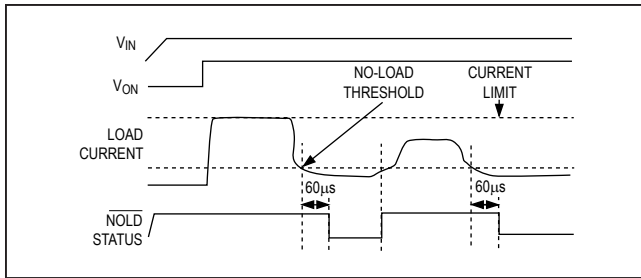

Figure 1. MAX4826–MAX4831 No-Load Flag Response

**FFLG Indicator**

The MAX4826–MAX4831 feature a current-limit fault output,  $\overline{\text{FFLG}}$ . Whenever a current-limit fault is activated,  $\overline{\text{FFLG}}$  goes low and the switch turns off.  $\overline{\text{FFLG}}$  is an open-drain output transistor and requires an external pullup resistor from  $\overline{\text{FFLG}}$  to IN. During shutdown (ON is low), the pulldown on the  $\overline{\text{FFLG}}$  output is released to limit power dissipation.  $\overline{\text{FFLG}}$  goes low when any of the following conditions occur:

- The die temperature exceeds the thermal shut-down temperature limit of +150°C.
- The device is in current limit for more than the fault-blanking period.
- $V_{\text{IN}}$  is below the UVLO threshold.

**NOLD Indicator**

The MAX4826–MAX4831 feature a no-load flag output,  $\overline{\text{NOLD}}$  (Figure 1). This output is pulled low every time the current coming out of the switch is less than 10mA (MAX4826–MAX4829), or 5mA (MAX4830/MAX4831).  $\overline{\text{NOLD}}$  is an open-drain output transistor and requires an external pullup resistor from  $\overline{\text{NOLD}}$  to a supply up to +5.5V. Current through the switch is intended to be positive (from IN to OUT), and for currents that are large in magnitude but negative in sign (OUT to IN),  $\overline{\text{NOLD}}$  asserts low. For options with the autoretry feature (MAX4827/MAX4829/MAX4831), the  $\overline{\text{NOLD}}$  output is high impedance during the  $t_{\text{RETRY}}$  period when a forward-current-limit condition is present. However,  $\overline{\text{NOLD}}$  is pulled low if a reverse current-limit condition is present during the  $t_{\text{RETRY}}$  period. A constant time filter is present at the output of  $\overline{\text{NOLD}}$  that gives a 60 $\mu$ s delay when a no-load condition is asserted. Deassertion of  $\overline{\text{NOLD}}$  is not delayed. During shutdown (ON is low), the pulldown on  $\overline{\text{NOLD}}$  is released to limit power dissipation.

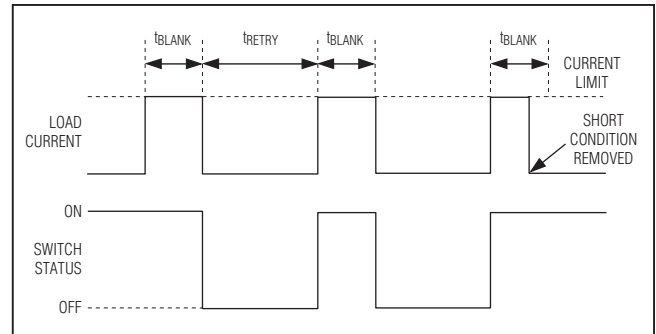

Figure 2. MAX4827/MAX4829/MAX4831 Autoretry Fault Blanking Diagram

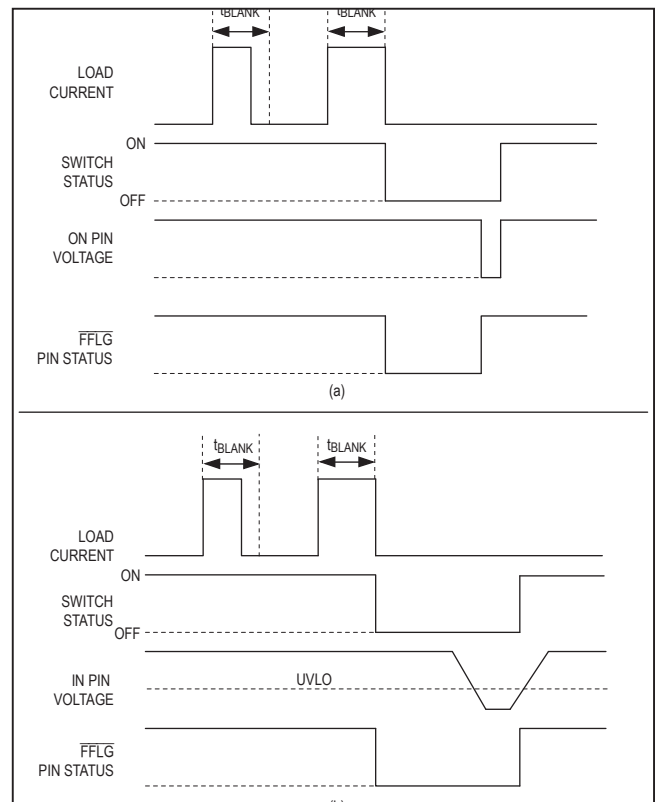

Figure 3. MAX4826/MAX4828/MAX4830 Latchoff Fault Blanking

**Autoretry (MAX4827/MAX4829/MAX4831)**

When the forward- or reverse-current-limit threshold is exceeded, the  $t_{\text{BLANK}}$  timer begins counting (Figure 2). The timer resets if the overcurrent condition disappears

before  $t_{\text{BLANK}}$  has elapsed. A retry time delay,  $t_{\text{RETRY}}$ , is started immediately after  $t_{\text{BLANK}}$  has elapsed, and during that time the switch is latched off. At the end of  $t_{\text{RETRY}}$ , the switch is turned on again. If the fault still exists, the cycle is repeated. If the fault has been removed, the switch stays on.

The autoretry feature saves system power in the case of an overcurrent or short-circuit condition. During  $t_{\text{BLANK}}$ , when the switch is on, the supply current is at the current limit. During  $t_{\text{RETRY}}$ , when the switch is off, no current flows through the switch. Instead of observing the full load current, the switch sees the equivalent load current, multiplied by the duty cycle or  $I_{\text{SUPPLY}} = I_{\text{LOAD}} \times t_{\text{BLANK}} / (t_{\text{BLANK}} + t_{\text{RETRY}})$ . With a typical  $t_{\text{BLANK}} = 37\text{ms}$  and typical  $t_{\text{RETRY}} = 518\text{ms}$ , the duty cycle is 6% which results in a 94% power savings, as opposed to the switch being on the entire time. The duty cycle is consistent across the process and devices.

### Latchoff (MAX4826/MAX4828/MAX4830)

When the forward- or reverse-current-limit threshold is exceeded, the  $t_{\text{BLANK}}$  timer begins counting. The timer resets if the overcurrent condition disappears before  $t_{\text{BLANK}}$  has elapsed. The switch is shut off if the overcurrent condition continues up to the end of the blanking time. Reset the switch by either toggling ON (Figure 3a), or cycling the input voltage below UVLO, typically 2V (Figure 3b).

### Fault Blanking

The MAX4826–MAX4831 feature 14ms (min) fault blanking. Fault blanking allows current-limit faults, including momentary short-circuit faults that occur when hot swapping a capacitive load. Fault blanking also ensures that no fault is issued during power-up. When a load transient causes the device to enter the current limit, an internal counter starts. If the load-transient fault persists beyond the fault-blanking timeout,  $\overline{\text{FFLG}}$  asserts low. Load-transient faults less than  $t_{\text{BLANK}}$  do not cause  $\overline{\text{FFLG}}$  assertion. Only current-limit faults are blanked.

A thermal fault and input voltage drops below the UVLO threshold cause  $\overline{\text{FFLG}}$  to assert immediately. These faults do not wait for the blanking time.

### Thermal Shutdown

The MAX4826–MAX4831 have a thermal-shutdown feature to protect the devices from overheating. The switch turns off and  $\overline{\text{FFLG}}$  goes low immediately (no fault blanking) when the junction temperature exceeds +150°C. The switches with the autoretry feature turn back on when the device temperature drops approximately 15°C. The switches with the latchoff feature require ON cycling.

## Applications Information

### Input Capacitor

To limit the input voltage drop during momentary output short-circuit conditions, connect a capacitor from IN to GND. A 0.1 $\mu$ F ceramic capacitor is adequate for most applications; however, higher capacitor values further reduce the voltage drop at the input and are recommended for lower voltage applications.

### Output Capacitance

Connect a 0.1 $\mu$ F capacitor from OUT to GND. This capacitor helps prevent inductive parasitics from pulling OUT negative during turn-off, thus preventing the MAX4826–MAX4831 from tripping erroneously. If the load capacitance is too large, current may not have enough time to charge the capacitance, and the device assumes that there is a faulty load condition. The maximum capacitive load value that can be driven from OUT is obtained by the following formula:

$$C_{\text{MAX}} < \frac{I_{\text{FWD\_MIN}} \times t_{\text{BLANK\_MIN}}}{V_{\text{IN}}}$$

### Layout and Thermal Dissipation

To optimize the switch response time to output short-circuit conditions, it is very important to keep all traces as short as possible to reduce the effect of undesirable parasitic inductance. Place input and output capacitors as close as possible to the device (no more than 5mm). IN and OUT pins must be connected with short traces to the power bus.

During normal operation, the power dissipation is small and the package temperature change is minimal. If the output is continuously shorted to ground at the maximum supply voltage, the operation of the switches with the autoretry option does not cause problems because the total power dissipated during the short is scaled by the duty cycle:

$$P_{\text{MAX}} < \frac{V_{\text{IN\_MAX}} \times I_{\text{OUT\_MAX}} \times t_{\text{BLANK}}}{t_{\text{RETRY}} + t_{\text{BLANK}}} = 88\text{mW}$$

where,

$V_{\text{IN\_MAX}} = 5.5\text{V}$ ,  $I_{\text{OUT\_MAX}} = 240\text{mA}$ ,  $t_{\text{BLANK}} = 37\text{ms}$ , and  $t_{\text{RETRY}} = 518\text{ms}$ .

Attention must be given to the MAX4826/MAX4828/MAX4830 where the latchoff condition must be manually reset by toggling ON from high to low. If the latchoff time duration is not sufficiently high, it is possible for the device to reach the thermal shutdown threshold and never be able to turn the device on until it cools down.

Pin Configuration

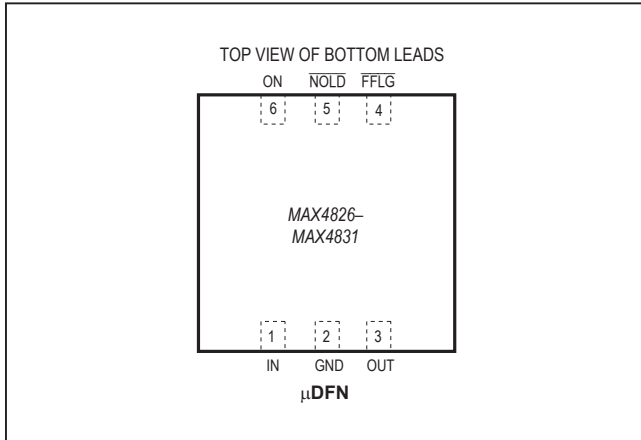

Typical Operating Circuit

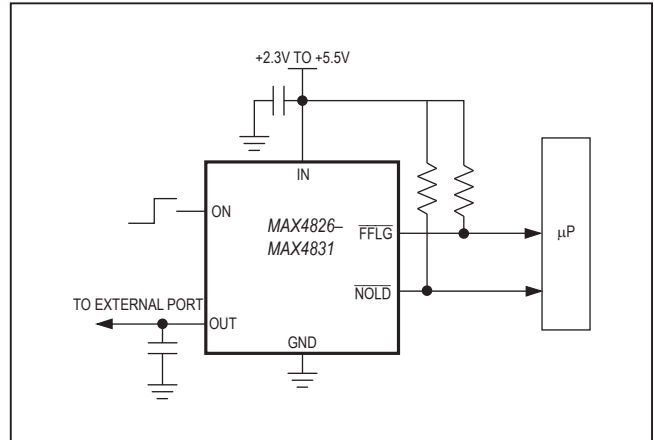

Functional Diagram

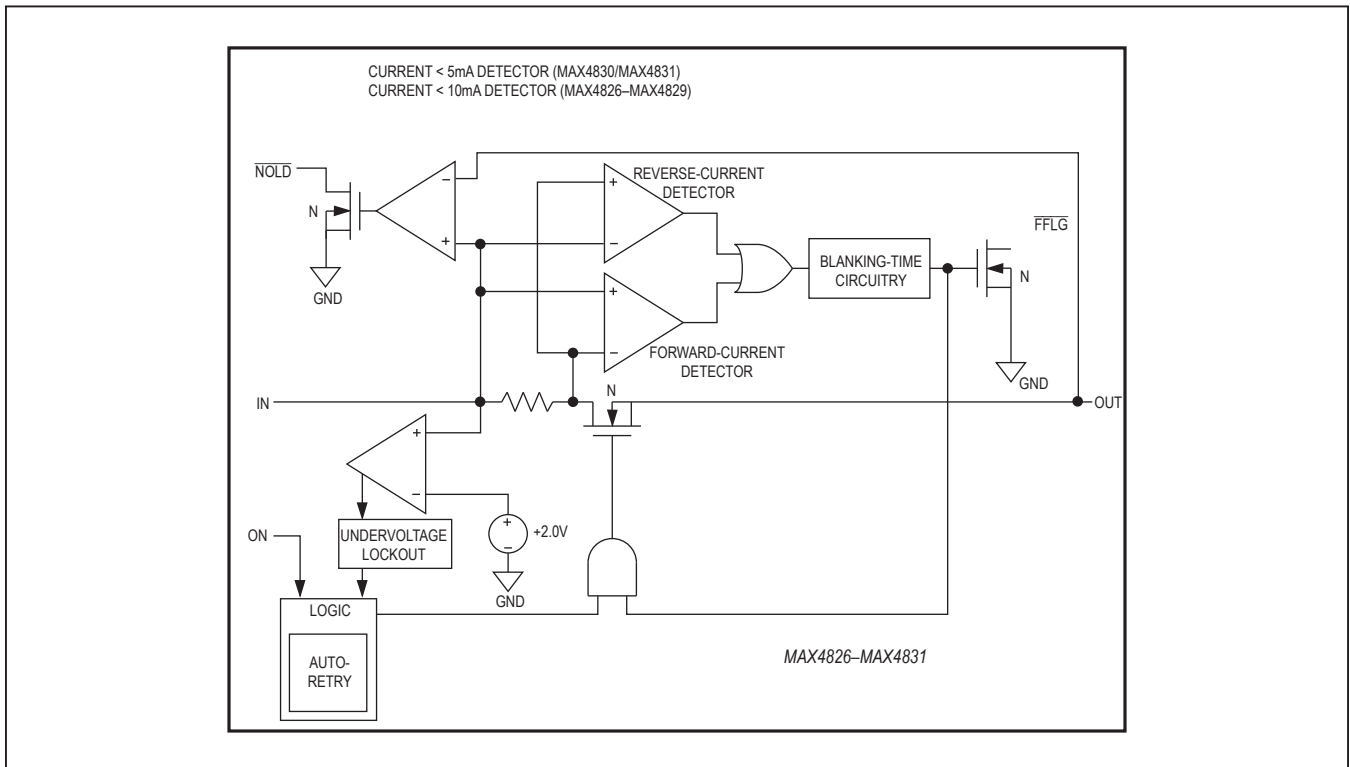

## Ordering Information/Selector Guide

PART	PIN-PACKAGE	MIN FULL-LOAD LIMIT (mA)	MAX NO-LOAD LIMIT (mA)	ON-RESISTANCE ( $\Omega$ ) $T_A = +25^\circ\text{C}$	MODE	TOP MARK
MAX4826ELT+T	6 $\mu$ DFN	50	10	1	Latchoff	AK
MAX4827ELT+T*	6 $\mu$ DFN	50	10	1	Autoretry	AL
MAX4828ELT+T*	6 $\mu$ DFN	100	10	1	Latchoff	AM
MAX4829ELT+T	6 $\mu$ DFN	100	10	1	Autoretry	AN
MAX4830ELT+T	6 $\mu$ DFN	50	5	2	Latchoff	AO
MAX4830ELT/V+T†	6 $\mu$ DFN	50	5	2	Latchoff	OX
MAX4831ELT+T*	6 $\mu$ DFN	50	5	2	Autoretry	AP

**Note:** All devices operate over the  $-40^\circ\text{C}$  to  $+85^\circ\text{C}$  operating range.

T = Tape and reel.

\*Future product—contact factory for availability.

/V denotes an automotive qualified part.

† denotes a part that is Not Recommended for New Designs

## Chip Information

PROCESS: BiCMOS

## Revision History

REVISION NUMBER	REVISION DATE	DESCRIPTION	PAGES CHANGED
0	5/05	Initial release.	—
1	8/09	Added new automotive part MAX4830ELT/V+T to the <i>Ordering Information/Selector Guide</i> table. Added “+T” to all the part numbers in the <i>Ordering Information/Selector Guide</i> table.	1
2	5/19	Marked MAX4830ELT/V+T as Not Recommended for New Designs	10

For pricing, delivery, and ordering information, please visit Maxim Integrated's online storefront at <https://www.maximintegrated.com/en/storefront/storefront.html>.

Maxim Integrated cannot assume responsibility for use of any circuitry other than circuitry entirely embodied in a Maxim Integrated product. No circuit patent licenses are implied. Maxim Integrated reserves the right to change the circuitry and specifications without notice at any time. The parametric values (min and max limits) shown in the Electrical Characteristics table are guaranteed. Other parametric values quoted in this data sheet are provided for guidance.

## Looking for pricing, stock, or lifecycle information?

Click below to explore more details on WIN SOURCE:

 [View MAX4831ELT+T on WIN SOURCE](#)

 [Maxim Integrated Information](#)

## Optimize Your Supply Chain with WIN SOURCE Solutions

-  Global Sourcing Solution
-  Obsolete Management
-  Cost Control Management
-  Shortage Management
-  Alternative Solution
-  Excess Inventory Management