



**THE DATASHEET OF  
MAX4619CUE+**



## High-Speed, Low-Voltage, CMOS Analog Multiplexers/Switches

### General Description

The MAX4617/MAX4618/MAX4619 are high-speed, low-voltage, CMOS analog ICs configured as an 8-channel multiplexer (MAX4617), two 4-channel multiplexers (MAX4618), and three single-pole/double-throw (SPDT) switches (MAX4619).

These CMOS devices can operate continuously with a +2V to +5.5V single supply. Each switch can handle rail-to-rail analog signals. The off-leakage current is only 1nA at  $T_A = +25^\circ\text{C}$  and 10nA at  $T_A = +85^\circ\text{C}$ .

All digital inputs have 0.8V to 2.4V logic thresholds, ensuring TTL/CMOS-logic compatibility when using a single +5V supply.

### Applications

Battery-Operated Equipment

Audio/Video Signal Routing

Low-Voltage Data-Acquisition Systems

Communications Circuits

### Features

- ◆ **Fast Switching Times**  
15ns tON  
10ns tOFF
- ◆ **Pin Compatible with Industry-Standard 74HC4051/74HC4052/74HC4053 and MAX4581/MAX4582/MAX4583**
- ◆ **Guaranteed On-Resistance**  
10Ω max (+5V Supply)  
20Ω max (+3V Supply)
- ◆ **Guaranteed 1Ω On-Resistance Match Between Channels (single +5V supply)**
- ◆ **Guaranteed Low Off-Leakage Current:**  
1nA at +25°C
- ◆ **Guaranteed Low On-Leakage Current:**  
1nA at +25°C
- ◆ **+2V to +5.5V Single-Supply Operation**
- ◆ **TTL/CMOS-Logic Compatible**
- ◆ **Low Crosstalk: <-96dB**
- ◆ **High Off-Isolation: <-93dB**
- ◆ **Low Distortion: <0.017% (600Ω)**

### Ordering Information

PART	TEMP RANGE	PIN-PACKAGE
MAX4617CUE+T	0°C to +70°C	16 TSSOP
MAX4617CSE+T	0°C to +70°C	16 Narrow SO
MAX4617CPE+T	0°C to +70°C	16 Plastic DIP

+ Denotes a lead(Pb)-free/RoHS-compliant package.

T = Tape and reel.

Ordering Information continued at end of data sheet.

### Pin Configurations/Functional Diagrams

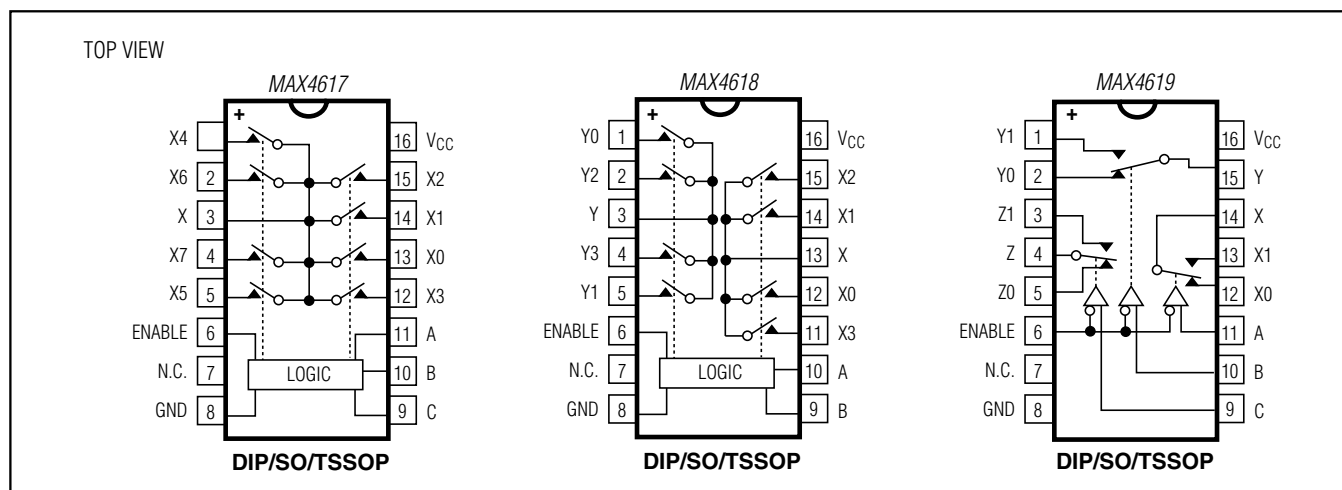

**For pricing, delivery, and ordering information, please contact Maxim Direct at 1-888-629-4642, or visit Maxim's website at [www.maximintegrated.com](http://www.maximintegrated.com).**

# MAX4617/MAX4618/MAX4619

## High-Speed, Low-Voltage, CMOS Analog Multiplexers/Switches

### ABSOLUTE MAXIMUM RATINGS

Voltages Referenced to GND

V<sub>CC</sub>, A, B, C, or Enable .....-0.3V to +6V

Voltage into Any Analog Terminal  
(Note 1) .....-0.3V to (V<sub>CC</sub> + 0.3V)

Continuous Current into Any Terminal .....±75mA

Peak Current, X<sub>-</sub>, Y<sub>-</sub>, Z<sub>-</sub>  
(pulsed at 1ms, 10% duty cycle) .....±200mA

Continuous Power Dissipation (T<sub>A</sub> = +70°C)

TSSOP (derate 9.4mW/°C above +70°C) .....755mW

Narrow SO (derate 8.70mW/°C above +70°C) .....696mW

Plastic DIP (derate 10.53mW/°C above +70°C) .....842mW

Operating Temperature Ranges

MAX461\_C\_ \_ .....0°C to +70°C

MAX461\_E\_ \_ .....-40°C to +85°C

Storage Temperature Range .....-65°C to +150°C

Lead Temperature (soldering, 10sec) .....+300°C

Soldering Temperature (reflow) .....+260°C

**Note 1:** Voltages exceeding V<sub>CC</sub> or GND on any analog signal terminal are clamped by internal diodes. Limit forward-diode current to maximum current rating.

Stresses beyond those listed under “Absolute Maximum Ratings” may cause permanent damage to the device. These are stress ratings only, and functional operation of the device at these or any other conditions beyond those indicated in the operational sections of the specifications is not implied. Exposure to absolute maximum rating conditions for extended periods may affect device reliability.

### ELECTRICAL CHARACTERISTICS—Single +5V Supply

(V<sub>CC</sub> = +4.5V to +5.5V, V<sub>H</sub> = 2.4V, V<sub>L</sub> = 0.8V, T<sub>A</sub> = T<sub>MIN</sub> to T<sub>MAX</sub>, unless otherwise noted. Typical values are at T<sub>A</sub> = +25°C.) (Note 2)

PARAMETER	SYMBOL	CONDITIONS	MIN	TYP	MAX	UNITS	
<b>ANALOG SWITCH</b>							
Analog-Signal Range	V <sub>X</sub> , V <sub>Y</sub> , V <sub>Z</sub>		C, E	0	V <sub>CC</sub>	V	
Switch On-Resistance	R <sub>ON</sub>	V <sub>CC</sub> = 4.5V; I <sub>X</sub> , I <sub>Y</sub> , I <sub>Z</sub> = 10mA; V <sub>X</sub> , V <sub>Y</sub> , V <sub>Z</sub> = 3V	T <sub>A</sub> = +25°C	8	10	Ω	
			C, E		13		
Switch On-Resistance Match Between Channels (Note 3)	ΔR <sub>ON</sub>	V <sub>CC</sub> = 5V; I <sub>X</sub> , I <sub>Y</sub> , I <sub>Z</sub> = 10mA; V <sub>X</sub> , V <sub>Y</sub> , V <sub>Z</sub> = 3V	T <sub>A</sub> = +25°C	0.2	1	Ω	
			C, E		1.2		
Switch On-Resistance Flatness (Note 4)	R <sub>FLAT(ON)</sub>	V <sub>CC</sub> = 5V; I <sub>X</sub> , I <sub>Y</sub> , I <sub>Z</sub> = 10mA; V <sub>X</sub> , V <sub>Y</sub> , V <sub>Z</sub> = 1V, 2V, 3V	C, E		1	Ω	
X <sub>-</sub> , Y <sub>-</sub> , Z <sub>-</sub> Off-Leakage Current (Note 5)	I <sub>X(OFF)</sub> , I <sub>Y(OFF)</sub> , I <sub>Z(OFF)</sub>	V <sub>CC</sub> = 5.5V; V <sub>X-</sub> , V <sub>Y-</sub> , V <sub>Z-</sub> = 4.5V, 1V; V <sub>X</sub> , V <sub>Y</sub> , V <sub>Z</sub> = 1V, 4.5V	T <sub>A</sub> = +25°C	-1	0.002	1	nA
			C, E	-10		10	
X, Y, Z Off-Leakage Current (Note 5)	I <sub>X(OFF)</sub> , I <sub>Y(OFF)</sub> , I <sub>Z(OFF)</sub>	V <sub>CC</sub> = 5.5V; V <sub>EE</sub> = -5.5V; V <sub>X-</sub> , V <sub>Y-</sub> , V <sub>Z-</sub> = 4.5V, 1V; V <sub>X</sub> , V <sub>Y</sub> , V <sub>Z</sub> = 1V, 4.5V	T <sub>A</sub> = +25°C	-1	0.002	1	nA
			C, E	-10		10	
X, Y, Z On-Leakage Current (Note 5)	I <sub>X(ON)</sub> , I <sub>Y(ON)</sub> , I <sub>Z(ON)</sub>	V <sub>CC</sub> = 5.5V; V <sub>X</sub> , V <sub>Y</sub> , V <sub>Z</sub> = 1V, 4.5V; V <sub>X-</sub> , V <sub>Y-</sub> , V <sub>Z-</sub> = 1V, 4.5V or unconnected	T <sub>A</sub> = +25°C	-1	0.002	1	nA
			C, E	-10		10	
<b>DIGITAL I/O</b>							
Input Voltage High	V <sub>AH</sub> , V <sub>BH</sub> , V <sub>CH</sub> , V <sub>ENABLEH</sub>		C, E	2.4		V	
Input Voltage Low	V <sub>AL</sub> , V <sub>BL</sub> , V <sub>CL</sub> , V <sub>ENABLEL</sub>		C, E		0.8	V	

# MAX4617/MAX4618/MAX4619

## High-Speed, Low-Voltage, CMOS Analog Multiplexers/Switches

### ELECTRICAL CHARACTERISTICS—Single +5V Supply (continued)

( $V_{CC} = +4.5V$  to  $+5.5V$ ,  $V_H = 2.4V$ ,  $V_L = 0.8V$ ,  $T_A = T_{MIN}$  to  $T_{MAX}$ , unless otherwise noted. Typical values are at  $T_A = +25^\circ C$ .) (Note 2)

PARAMETER	SYMBOL	CONDITIONS		MIN	TYP	MAX	UNITS
Input Current High	$I_{AH}$ , $I_{BH}$ , $I_{CH}$ , $I_{ENABLE}$	$V_A, V_B, V_C = V_{ENABLE} = V_{CC}$	C, E	-1	0.0003	1	$\mu A$
Input Current Low	$I_{AL}$ , $I_{BL}$ , $I_{CL}$ , $I_{ENABLE}$	$V_A, V_B, V_C = V_{ENABLE} = 0$	C, E	-1	0.0003	1	$\mu A$
<b>SWITCH DYNAMIC CHARACTERISTICS</b>							
Enable Turn-On Time (Note 6)	$t_{ON}$	$V_{X\_}, V_{Y\_}, V_{Z\_} = 3V$ ; $R_L = 300\Omega$ ; $C_L = 35pF$ ; Figure 3	$T_A = +25^\circ C$	7	15	ns	
			C, E		18		
Enable Turn-Off Time (Note 6)	$t_{OFF}$	$V_{X\_}, V_{Y\_}, V_{Z\_} = 3V$ ; $R_L = 300\Omega$ ; $C_L = 35pF$ ; Figure 3	$T_A = +25^\circ C$	4.5	10	ns	
			C, E		13		
Address Transition Time (Note 6)	$t_{TRANS}$	$V_{X\_}, V_{Y\_}, V_{Z\_} = 3V$ ; $R_L = 300\Omega$ ; $C_L = 35pF$ ; Figure 2	$T_A = +25^\circ C$	7	15	ns	
			C, E		18		
Break-Before-Make Time (Note 6)	$t_{BBM}$	$V_{X\_}, V_{Y\_}, V_{Z\_} = 3V$ ; $R_L = 300\Omega$ ; $C_L = 35pF$ ; Figure 4	$T_A = +25^\circ C$	0.2	1.5	ns	
Charge Injection	Q	$C = 1nF$ , $R_S = 0$ , $V_S = 0$ , Figure 5	$T_A = +25^\circ C$		3	pC	
Input Off-Capacitance	$C_{X(OFF)}$ , $C_{Y(OFF)}$ , $C_{Z(OFF)}$	$V_{X\_}, V_{Y\_}, V_{Z\_} = 0$ ; $f = 1MHz$ ; Figure 7	$T_A = +25^\circ C$		5	pF	
Output Off-Capacitance	$C_{X(OFF)}$ , $C_{Y(OFF)}$ , $C_{Z(OFF)}$	$V_{X\_}, V_{Y\_}, V_{Z\_} = 0$ ; $f = 1MHz$ ; Figure 7	$T_A = +25^\circ C$	MAX4617	27	pF	
				MAX4618	15		
				MAX4619	8.5		
Output On-Capacitance	$C_{X(ON)}$ , $C_{Y(ON)}$ , $C_{Z(ON)}$	$V_{X\_}, V_{Y\_}, V_{Z\_} = 0$ ; $f = 1MHz$ ; Figure 7	$T_A = +25^\circ C$	MAX4617	32	pF	
				MAX4618	21		
				MAX4619	15.5		
Off-Isolation	$V_{ISO}$	$R_L = 50\Omega$ , $f = 100kHz$ , Figure 6	$T_A = +25^\circ C$		-93	dB	
Channel-to-Channel Crosstalk	$V_{CT}$	$R_L = 50\Omega$ , $f = 100kHz$ , Figure 6	$T_A = +25^\circ C$		-96	dB	
Total Harmonic Distortion	THD	$R_L = 600\Omega$ , $1Vp-p$ , $f = 20Hz$ to $20kHz$	$T_A = +25^\circ C$		0.017	%	
<b>POWER SUPPLY</b>							
Power-Supply Range	$V_{CC}$		C, E	+2	+5.5	V	
Power-Supply Current	$I_{CC}$	$V_{CC} = 5.5V$ ; $V_A, V_B, V_C, V_{ENABLE} = V_{CC}$ or 0	$T_A = +25^\circ C$	-1	1	$\mu A$	
			C, E	-10	10		

# MAX4617/MAX4618/MAX4619

## High-Speed, Low-Voltage, CMOS Analog Multiplexers/Switches

### ELECTRICAL CHARACTERISTICS—Single +3.3V Supply

( $V_{CC} = +3V$  to  $+3.6V$ ,  $V_{_H} = 2.0V$ ,  $V_{_L} = 0.5V$ ,  $T_A = T_{MIN}$  to  $T_{MAX}$ , unless otherwise noted. Typical values are at  $T_A = +25^\circ C$ .) (Note 2)

PARAMETER	SYMBOL	CONDITIONS	MIN	TYP	MAX	UNITS	
<b>ANALOG SWITCH</b>							
Analog-Signal Range	$V_{X\_}, V_{Y\_}, V_{Z\_},$ $V_X, V_Y, V_Z$		C, E	0	$V_{CC}$	V	
Switch On-Resistance	$R_{ON}$	$V_{CC} = 3V$ ; $I_X, I_Y, I_Z = 10mA$ ; $V_X, V_Y, V_Z = 1.5V$	$T_A = +25^\circ C$	8	20	$\Omega$	
			C, E		25		
$X\_ , Y\_ , Z\_ $ Off-Leakage Current (Note 5)	$I_{X(OFF)},$ $I_{Y(OFF)},$ $I_{Z(OFF)}$	$V_{CC} = 3.6V$ ; $V_{X\_}, V_{Y\_}, V_{Z\_} = 1V, 3V$ ; $V_X, V_Y, V_Z = 3V, 1V$	$T_A = +25^\circ C$	-1	0.002	1	nA
			C, E	-10		10	
$X, Y, Z$ Off-Leakage Current (Note 6)	$I_{X(OFF)},$ $I_{Y(OFF)},$ $I_{Z(OFF)}$	$V_{CC} = 3.6V$ ; $V_{X\_}, V_{Y\_}, V_{Z\_} = 1V, 3V$ ; $V_X, V_Y, V_Z = 3V, 1V$	$T_A = +25^\circ C$	-1	0.002	1	nA
			C, E	-10		10	
$X, Y, Z$ On-Leakage Current (Note 6)	$I_{X(ON)},$ $I_{Y(ON)},$ $I_{Z(ON)}$	$V_{CC} = 3.6V$ ; $V_X, V_Y, V_Z = 3V, 1V$ ; $V_{X\_}, V_{Y\_}, V_{Z\_} = 3V, 1V$ , or unconnected	$T_A = +25^\circ C$	-1	0.002	1	nA
			C, E	-10		10	
<b>DIGITAL I/O</b>							
Input Voltage High	$V_{AH}, V_{BH}, V_{CH},$ $V_{ENABLEH}$		C, E	2.0		V	
Input Voltage Low	$V_{AL}, V_{BL}, V_{CL},$ $V_{ENABLEL}$		C, E		0.5	V	
Input Current High	$I_{AH}, I_{BH}, I_{CH},$ $I_{ENABLEH}$	$V_A, V_B, V_C = V_{ENABLE} = V_{CC}$	C, E	-1	0.0003	1	$\mu A$
Input Current Low	$I_{AL}, I_{BL}, I_{CL},$ $I_{ENABLEL}$	$V_A, V_B, V_C = V_{ENABLE} = 0$	C, E	-1	0.0003	1	$\mu A$
<b>SWITCH DYNAMIC CHARACTERISTICS</b>							
Enable Turn-On Time (Note 6)	$t_{ON}$	$V_{X\_}, V_{Y\_}, V_{Z\_} = 1.5V$ ; $R_L = 300\Omega$ ; $C_L = 35pF$ ; Figure 3	$T_A = +25^\circ C$	9	20	ns	
			C, E		25		
Enable Turn-Off Time (Note 6)	$t_{OFF}$	$V_{X\_}, V_{Y\_}, V_{Z\_} = 1.5V$ ; $R_L = 300\Omega$ ; $C_L = 35pF$ ; Figure 3	$T_A = +25^\circ C$	6	15	ns	
			C, E		20		
Address Transition Time (Note 6)	$t_{TRANS}$	$V_{X\_}, V_{Y\_}, V_{Z\_} = 1.5V/0$ ; $R_L = 300\Omega$ ; $C_L = 35pF$ ; Figure 2	$T_A = +25^\circ C$	9	20	ns	
			C, E		25		
Break-Before-Make Time (Note 6)	$t_{BBM}$	$V_{X\_}, V_{Y\_}, V_{Z\_} = 1.5V$ ; $R_L = 300\Omega$ ; $C_L = 35pF$	$T_A = +25^\circ C$	0.2	1.5	ns	
Charge Injection (Note 6)	Q	$C = 1nF, R_S = 0, V_S = 0$ , Figure 5	$T_A = +25^\circ C$	3		pC	
<b>POWER SUPPLY</b>							
Power-Supply Current	$I_{CC}$	$V_{CC} = 3.6V$ , $V_A, V_B, V_C, V_{ENABLE} = V_{CC}$ or 0	$T_A = +25^\circ C$		1	$\mu A$	
			C, E		10		

# MAX4617/MAX4618/MAX4619

## High-Speed, Low-Voltage, CMOS Analog Multiplexers/Switches

### ELECTRICAL CHARACTERISTICS—Single +2.5V Supply

( $V_{CC} = +2.5V$ ,  $T_A = T_{MIN}$  to  $T_{MAX}$ , unless otherwise noted. Typical values are at  $T_A = +25^\circ C$ .) (Note 2)

PARAMETER	SYMBOL	CONDITIONS	MIN	TYP	MAX	UNITS
<b>ANALOG SWITCH</b>						
Switch On-Resistance	RON	$V_{CC} = 2.5V$ ; $I_X, I_Y, I_Z = 10mA$ ; $V_X, V_Y, V_Z = 1.2V$	$T_A = +25^\circ C$	30	60	$\Omega$
			C, E		100	
<b>SWITCH DYNAMIC CHARACTERISTICS</b>						
Enable Turn-On Time (Note 6)	t <sub>ON</sub>	$V_{X-}, V_{Y-}, V_{Z-} = 1V$ ; $R_L = 300\Omega$ ; $C_L = 35pF$ ; Figure 3	$T_A = +25^\circ C$	12		ns
Enable Turn-Off Time (Note 6)	t <sub>OFF</sub>	$V_{X-}, V_{Y-}, V_{Z-} = 1V$ ; $R_L = 300\Omega$ ; $C_L = 35pF$ ; Figure 3	$T_A = +25^\circ C$	10		ns
Address Transition Time (Note 6)	t <sub>TRANS</sub>	$V_{X-}, V_{Y-}, V_{Z-} = 1V$ ; $R_L = 300\Omega$ ; $C_L = 35pF$ ; Figure 3	$T_A = +25^\circ C$	12		ns

**Note 2:** The algebraic convention is used in this data sheet; the most negative value is shown in the minimum column.

**Note 3:**  $\Delta R_{ON} = R_{ON(MAX)} - R_{ON(MIN)}$ .

**Note 4:** Flatness is defined as the difference between the maximum and minimum value of on-resistance as measured over the specified analog signal ranges; i.e.,  $V_{X-}, V_{Y-}, V_{Z-} = 3V$  to 0 and 0 to  $-3V$ .

**Note 5:** Leakage parameters are 100% tested at maximum-rated hot operating temperature, and guaranteed by correlation at  $T_A = +25^\circ C$ .

**Note 6:** Guaranteed by design, not production tested.

# MAX4617/MAX4618/MAX4619

## High-Speed, Low-Voltage, CMOS Analog Multiplexers/Switches

### Typical Operating Characteristics

( $V_{CC} = +5V$ ,  $GND = 0$ ,  $T_A = +25^\circ C$ , unless otherwise noted.)

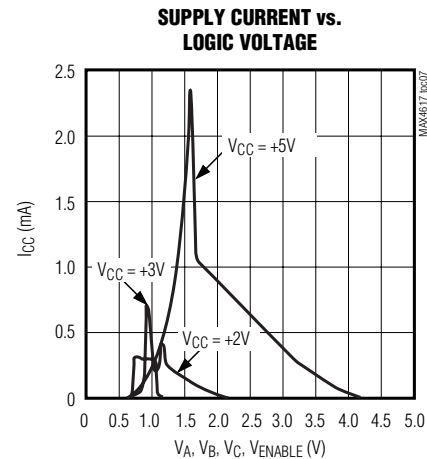
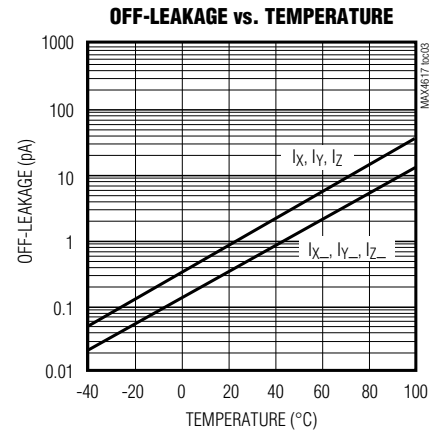
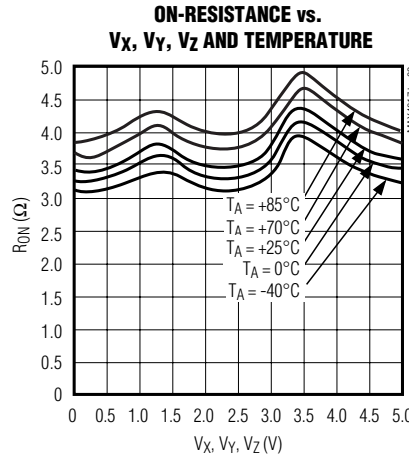

# MAX4617/MAX4618/MAX4619

## High-Speed, Low-Voltage, CMOS Analog Multiplexers/Switches

### Typical Operating Characteristics (continued)

( $V_{CC} = +5V$ ,  $GND = 0$ ,  $T_A = +25^\circ C$ , unless otherwise noted.)

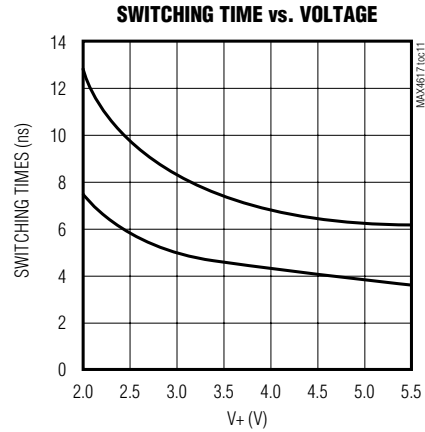
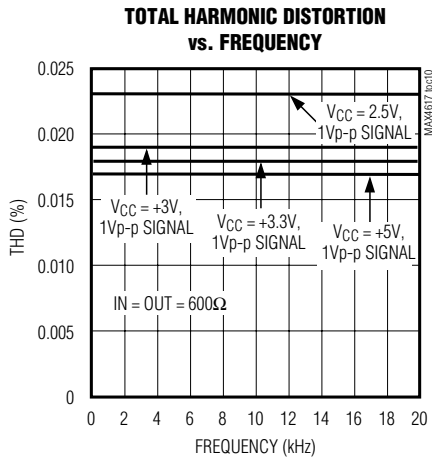
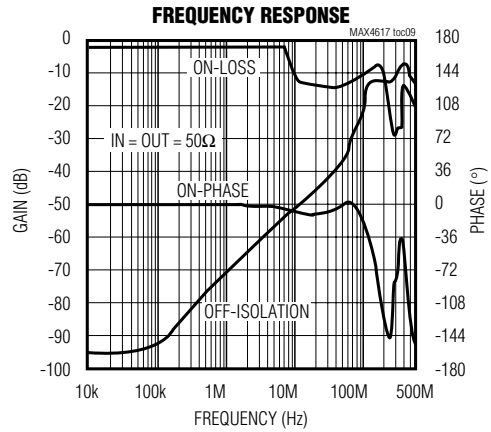
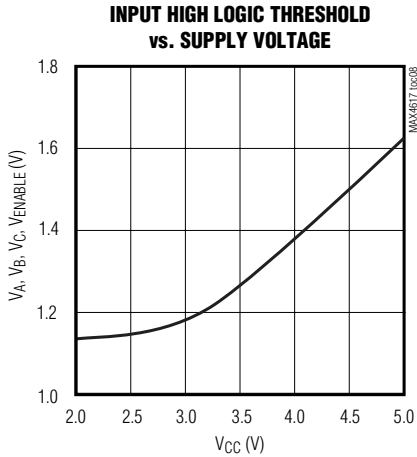

# MAX4617/MAX4618/MAX4619

## High-Speed, Low-Voltage, CMOS Analog Multiplexers/Switches

### Pin Description

PIN			NAME	FUNCTION
MAX4617	MAX4618	MAX4619		
13, 14, 15, 12, 1, 5, 2, 4	—	—	X0–X7	Analog Switch Inputs 0–7
3	—	—	X	Analog Switch Output
—	12, 14, 15, 11	—	X0, X1, X2, X3	Analog Switch “X” Inputs 0–3
—	13	14	X	Analog Switch “X” Output
—	—	13	X1	Analog Switch “X” Normally Open Input
—	—	12	X0	Analog Switch “X” Normally Closed Input
—	—	1	Y1	Analog Switch “Y” Normally Open Input
—	—	2	Y0	Analog Switch “Y” Normally Closed Input
6	6	6	ENABLE	Digital Enable Input. Normally connect to GND. Can be driven to logic high to set all switches off.
7	7	7	N.C.	No Connection. Not Internally connected.
8	8	8	GND	Ground
11	10	11	A	Digital Address “A” Input
10	9	10	B	Digital Address “B” Input
9	—	9	C	Digital Address “C” Input
—	1, 5, 2, 4	—	Y0, Y1, Y2, Y3	Analog Switch “Y” Inputs 0–3
—	3	15	Y	Analog Switch “Y” Output
—	—	5	Z0	Analog Switch “Z” Normally Closed Input
—	—	3	Z1	Analog Switch “Z” Normally Open Input
—	—	4	Z	Analog Switch “Z” Output
16	16	16	VCC	Positive Analog and Digital Supply Voltage Input

**Note:** Input and output pins are identical and interchangeable. Any may be considered an input or output; signals pass equally well in both directions.

### Applications Information

#### Power-Supply Considerations

##### Overview

The MAX4617/MAX4618/MAX4619 construction is typical of most CMOS analog switches. They have two supply pins: VCC and GND. VCC and GND are used to drive the internal CMOS switches and set the limits of the analog voltage on any switch. Reverse ESD-protection diodes are internally connected between each analog-signal pin and both VCC and GND. If any analog signal exceeds VCC or GND, one of these diodes conducts. During normal operation, these and other reverse-biased ESD diodes leak, forming the only current drawn from VCC or GND.

Virtually all the analog leakage current comes from the ESD diodes. Although the ESD diodes on a given signal pin are identical and therefore fairly well balanced, they are reverse biased differently. Each is biased by either VCC or GND and the analog signal. This means their leakages will vary as the signal varies. The *difference* in the two diode leakages to the VCC and GND pins constitutes the analog-signal-path leakage current. All analog leakage current flows between each pin and one of the supply terminals, not to the other switch terminal. This is why both sides of a given switch can show leakage currents of either the same or opposite polarity.

VCC and GND power the internal logic and set the input logic limits. Logic inputs have ESD-protection diodes to ground.

# MAX4617/MAX4618/MAX4619

## High-Speed, Low-Voltage, CMOS Analog Multiplexers/Switches

The logic-level thresholds are TTL/CMOS compatible when  $V_{CC}$  is +5V. As  $V_{CC}$  rises, the threshold increases; as  $V_{CC}$  falls, the threshold decreases. For example, when  $V_{CC} = +3V$  the guaranteed minimum logic-high threshold decreases to 2.0V

### Power Supply

These devices operate from a single supply between +2.5V and +5.5V. All of the bipolar precautions must be observed. At room temperature, they actually “work” with a single supply near or below +2V, although as supply voltage decreases, switch on-resistance becomes very high.

### Overvoltage Protection

Proper power-supply sequencing is recommended for all CMOS devices. Do not exceed the absolute maximum ratings because stresses beyond the listed ratings can cause permanent damage to the devices. Always sequence  $V_{CC}$  on first, followed by the logic inputs and analog signals. If power-supply sequencing is not possible, add two small signal diodes (D1, D2) in series with the supply pins for overvoltage protection (Figure 1).

Adding diodes reduces the analog-signal range to one diode drop below  $V_{CC}$  and one diode drop above GND, but does not affect the devices' low switch resistance and low leakage characteristics. Device operation is unchanged, and the difference between  $V_{CC}$  and GND should not exceed 6V. These protection diodes are not recommended if signal levels must extend to ground.

### High-Frequency Performance

In  $50\Omega$  systems, signal response is reasonably flat up to 50MHz (see *Typical Operating Characteristics*). Above 20MHz, the on-response has several minor peaks that are highly layout dependent. The problem is not turning the switch on, but turning it off. The off-state switch acts like a capacitor and passes higher frequencies with less attenuation. At 10MHz, off-isolation is about -50dB in  $50\Omega$  systems, becoming worse (approximately 20dB per decade) as frequency increases. Higher circuit impedances also degrade off-isolation. Adjacent channel attenuation is about 3dB above that of a bare IC socket and is entirely due to capacitive coupling.

### Pin Nomenclature

The MAX4617/MAX4618/MAX4619 are pin compatible with the industry-standard 74HC4051/74HC4052/74HC4053 and the MAX4581/MAX4582/MAX4583. In single-supply applications, they function identically and have identical logic diagrams, although these parts differ electrically.

The pin designations and logic diagrams in this data sheet conform to the original 1972 specifications published by RCA for the CD4051/CD4052/CD4053. These designations differ from the standard Maxim switch and mux designations found on other Maxim data sheets (including the MAX4051/MAX4052/MAX4053) and may cause confusion. Designers who feel more comfortable with Maxim's standard designations are advised that the pin designations and logic diagrams on the MAX4051/MAX4052/MAX4053 data sheet may be freely applied to the MAX4617/MAX4618/MAX4619.

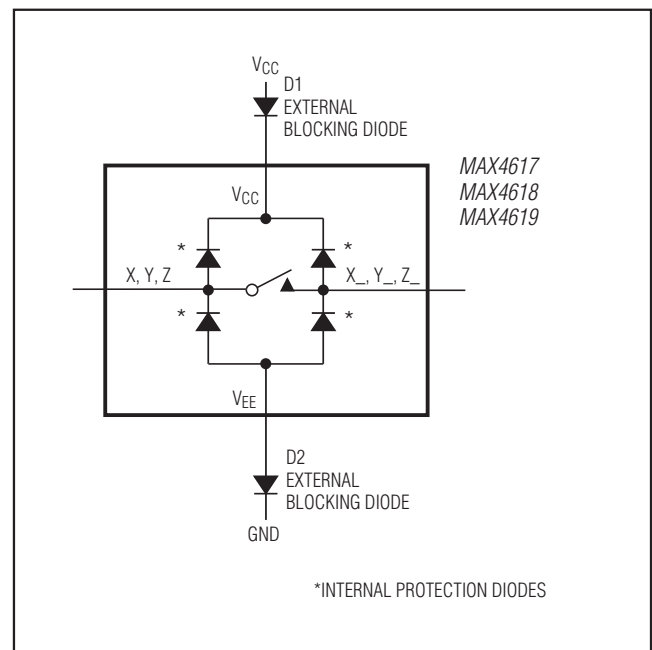

Figure 1. Overvoltage Protection Using External Blocking Diodes

# MAX4617/MAX4618/MAX4619

## High-Speed, Low-Voltage, CMOS Analog Multiplexers/Switches

Table 1. Truth Table/Switch Programming

ENABLE INPUT	SELECT INPUTS			ON SWITCHES		
	C*	B	A	MAX4617	MAX4618	MAX4619
H	X	X	X	All switches open	All switches open	All switches open
L	L	L	L	X-X0	X-X0, Y-Y0	X-X0, Y-Y0, Z-Z0
L	L	L	H	X-X1	X-X1, Y-Y1	X-X1, Y-Y0, Z-Z0
L	L	H	L	X-X2	X-X2, Y-Y2	X-X0, Y-Y1, Z-Z0
L	L	H	H	X-X3	X-X3, Y-Y3	X-X1, Y-Y1, Z-Z0
L	H	L	L	X-X4	X-X0, Y-Y0	X-X0, Y-Y0, Z-Z1
L	H	L	H	X-X5	X-X1, Y-Y1	X-X1, Y-Y0, Z-Z1
L	H	H	L	X-X6	X-X2, Y-Y2	X-X0, Y-Y1, Z-Z1
L	H	H	H	X-X7	X-X3, Y-Y3	X-X1, Y-Y1, Z-Z1

X = Don't care

\*C not present on MAX4618.

**Note:** Input and output pins are identical and interchangeable. Either may be considered an input or output; signals pass equally well in either direction.

# MAX4617/MAX4618/MAX4619

## High-Speed, Low-Voltage, CMOS Analog Multiplexers/Switches

### Test Circuits/Timing Diagrams

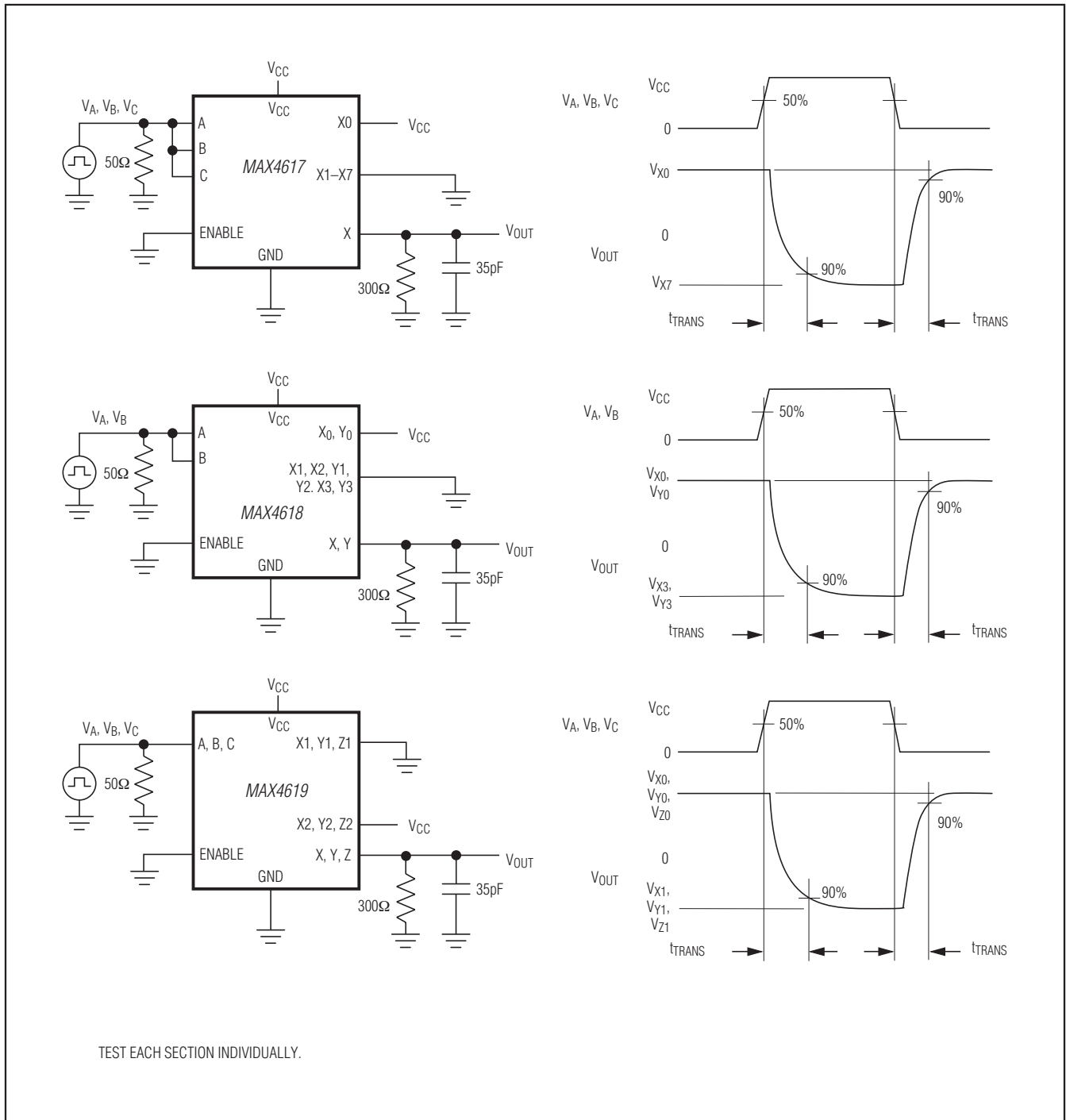

Figure 2. Address Transition Times

# MAX4617/MAX4618/MAX4619

## High-Speed, Low-Voltage, CMOS Analog Multiplexers/Switches

### Test Circuits/Timing Diagrams (continued)

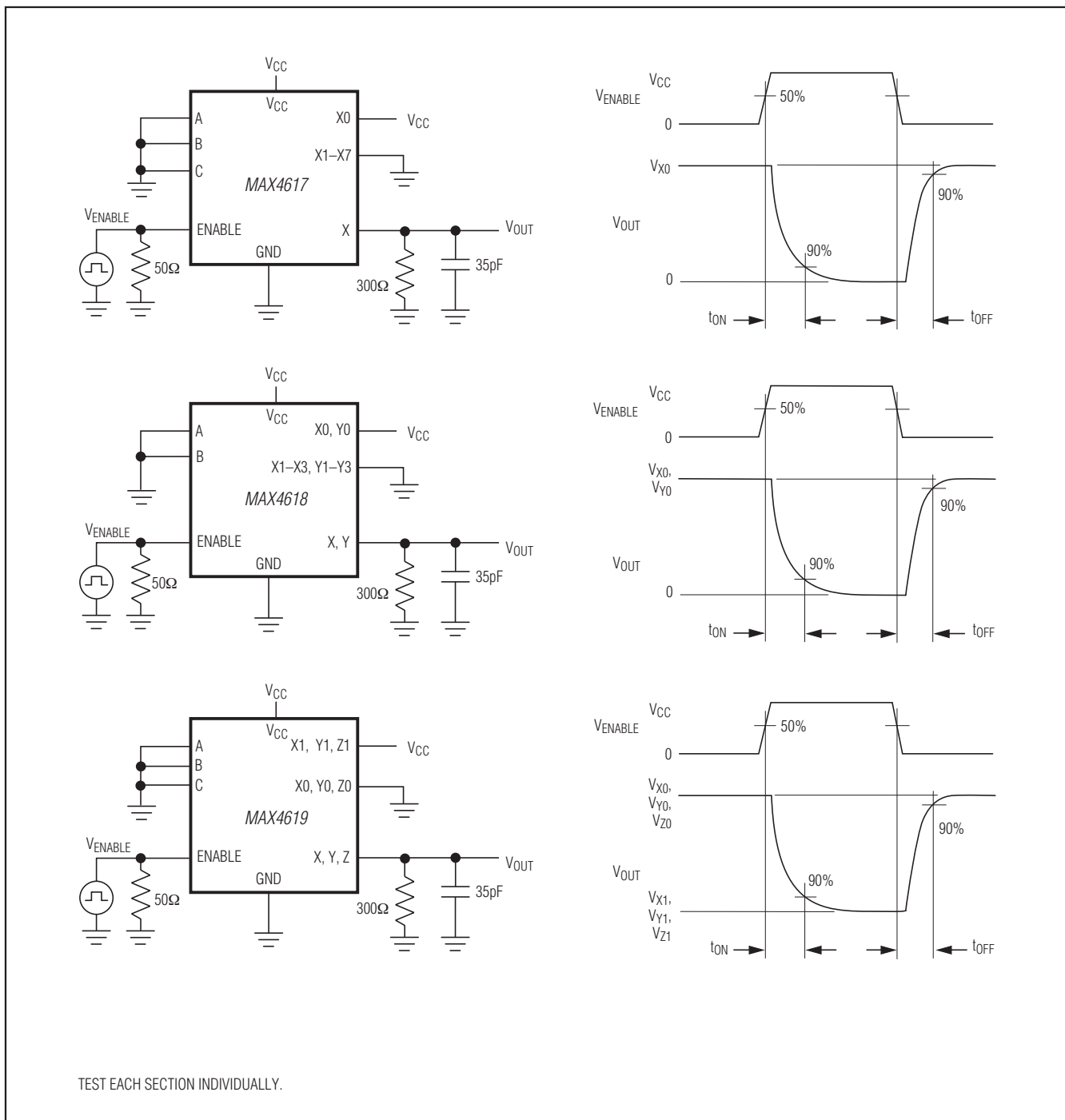

Figure 3. Enable Switching Times

# MAX4617/MAX4618/MAX4619

## High-Speed, Low-Voltage, CMOS Analog Multiplexers/Switches

### Test Circuits/Timing Diagrams (continued)



Figure 4. Break-Before-Make Interval



Figure 5. Charge Injection

# MAX4617/MAX4618/MAX4619

## High-Speed, Low-Voltage, CMOS Analog Multiplexers/Switches

### Test Circuits/Timing Diagrams (continued)



Figure 6. Off-Isolation, On-Loss, and Crosstalk

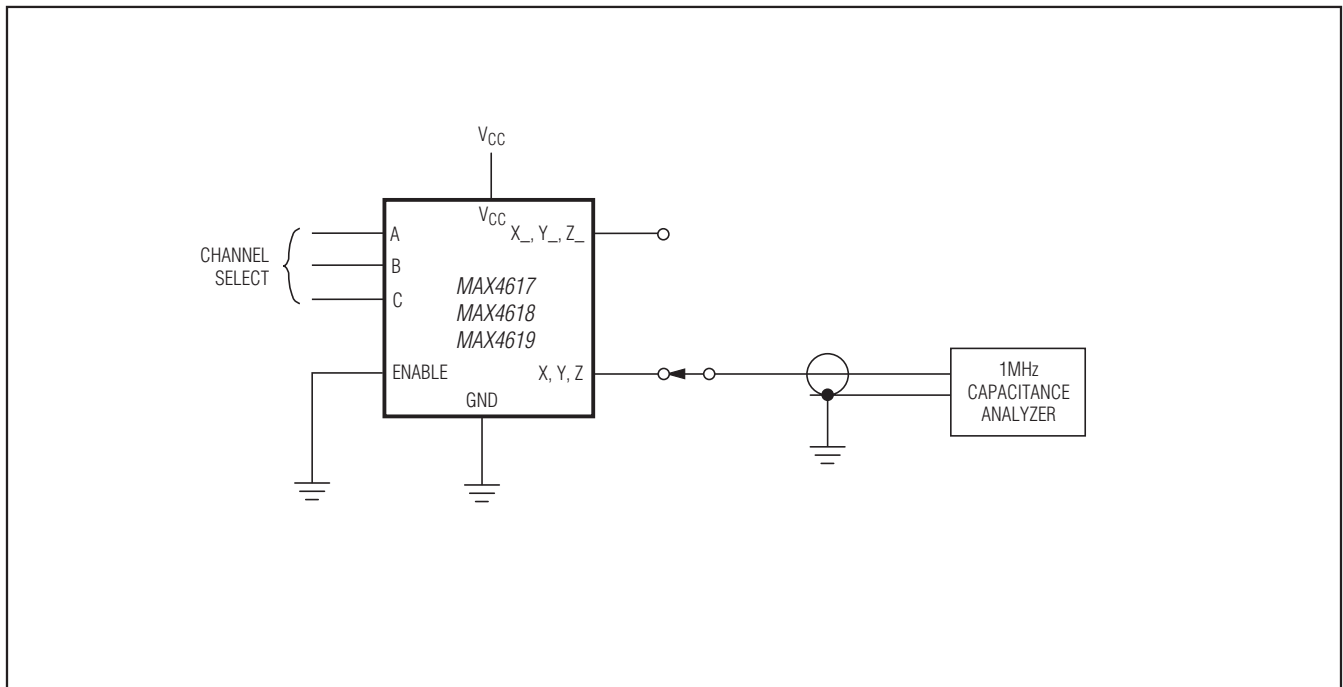

Figure 7. Capacitance

# MAX4617/MAX4618/MAX4619

## High-Speed, Low-Voltage, CMOS Analog Multiplexers/Switches

### Ordering Information (continued)

PART	TEMP RANGE	PIN-PACKAGE
MAX4617EUE+T	-40°C to +85°C	16 TSSOP
MAX4617ESE+T	-40°C to +85°C	16 Narrow SO
MAX4617EPE+T	-40°C to +85°C	16 Plastic DIP
<b>MAX4618</b> CUE+T	0°C to +70°C	16 TSSOP
MAX4618CSE+T	0°C to +70°C	16 Narrow SO
MAX4618CPE+T	0°C to +70°C	16 Plastic DIP
MAX4618EUE+T	-40°C to +85°C	16 TSSOP
MAX4618ESE+T	-40°C to +85°C	16 Narrow SO
MAX4618EPE+T	-40°C to +85°C	16 Plastic DIP
<b>MAX4619</b> CUE+T	0°C to +70°C	16 TSSOP
MAX4619CSE+T	0°C to +70°C	16 Narrow SO
MAX4619CPE+T	0°C to +70°C	16 Plastic DIP
MAX4619EUE+T	-40°C to +85°C	16 TSSOP
MAX4619ESE+T	-40°C to +85°C	16 Narrow SO
MAX4619EPE+T	-40°C to +85°C	16 Plastic DIP

+Denotes a lead(Pb)-free/RoHS-compliant package.

T = Tape and reel.

### Chip Information

PROCESS: BiCMOS

### Package Information

For the latest package outline information and land patterns (footprints), go to [www.maximintegrated.com/packages](http://www.maximintegrated.com/packages). Note that a "+", "#", or "-" in the package code indicates RoHS status only. Package drawings may show a different suffix character, but the drawing pertains to the package regardless of RoHS status.

PACKAGE TYPE	PACKAGE CODE	OUTLINE NO.	LAND PATTERN NO.
16 TSSOP	U16+2	<a href="#">21-0066</a>	<a href="#">90-0117</a>
16 Narrow SO	S16+3	<a href="#">21-0041</a>	<a href="#">90-0097</a>
16 PDIP	P16+1	<a href="#">21-0043</a>	—

# MAX4617/MAX4618/MAX4619

## High-Speed, Low-Voltage, CMOS Analog Multiplexers/Switches

### Revision History



REVISION NUMBER	REVISION DATE	DESCRIPTION	PAGES CHANGED
0	7/99	Initial release	—
1	8/01	Change specifications	2, 7
2	4/02	Added QFN package	1, 2, 5, 15
3	12/12	Added lead-free information to data sheet, removed QFN package	1, 2, 5, 15



Maxim Integrated cannot assume responsibility for use of any circuitry other than circuitry entirely embodied in a Maxim Integrated product. No circuit patent licenses are implied. Maxim Integrated reserves the right to change the circuitry and specifications without notice at any time. The parametric values (min and max limits) shown in the Electrical Characteristics table are guaranteed. Other parametric values quoted in this data sheet are provided for guidance.

## Looking for pricing, stock, or lifecycle information?

Click below to explore more details on WIN SOURCE:

-  View [MAX4619CUE+](#) on WIN SOURCE
-  [Maxim Integrated](#) Information

## Optimize Your Supply Chain with WIN SOURCE Solutions

-  Global Sourcing Solution
-  Obsolete Management
-  Cost Control Management
-  Shortage Management
-  Alternative Solution
-  Excess Inventory Management