



**THE DATASHEET OF
MAX4488AUT+T**



MAX4475–MAX4478/ MAX4488/MAX4489

General Description

The MAX4475–MAX4478/MAX4488/MAX4489 wide-band, low-noise, low-distortion operational amplifiers offer rail-to-rail outputs and single-supply operation down to 2.7V. They draw 2.2mA of quiescent supply current per amplifier while featuring ultra-low distortion (0.0002% THD+N), as well as low input voltage-noise density ($4.5\text{nV}/\sqrt{\text{Hz}}$) and low input current-noise density ($0.5\text{fA}/\sqrt{\text{Hz}}$). These features make the devices an ideal choice for applications that require low distortion and/or low noise.

For power conservation, the MAX4475/MAX4488 offer a low-power shutdown mode that reduces supply current to $0.01\mu\text{A}$ and places the amplifiers' outputs into a high-impedance state. These amplifiers have outputs which swing rail-to-rail and their input common-mode voltage range includes ground. The MAX4475–MAX4478 are unity-gain stable with a gain-bandwidth product of 10MHz. The MAX4488/4489 are internally compensated for gains of $+5\text{V}/\text{V}$ or greater with a gain-bandwidth product of 42MHz. The single MAX4475/MAX4476/MAX4488 are available in space-saving, 6-pin SOT23 and TDFN packages.

Applications

- ADC Buffers
- DAC Output Amplifiers
- Low-Noise Microphone/Preamplifiers
- Digital Scales
- Strain Gauges/Sensor Amplifiers
- Medical Instrumentation
- Automotive

μMAX is a registered trademark of Maxim Integrated Products, Inc.

SOT23, Low-Noise, Low-Distortion, Wide-Band, Rail-to-Rail Op Amps

Features

- Low Input Voltage-Noise Density: $4.5\text{nV}/\sqrt{\text{Hz}}$
- Low Input Current-Noise Density: $0.5\text{fA}/\sqrt{\text{Hz}}$
- Low Distortion: 0.0002% THD+N (1k Ω load)
- Single-Supply Operation from +2.7V to +5.5V
- Input Common-Mode Voltage Range Includes Ground
- Rail-to-Rail Output Swings with a 1k Ω Load
- 10MHz GBW Product, Unity-Gain Stable (MAX4475–MAX4478)
- 42MHz GBW Product, Stable with $A\text{V} \geq +5\text{V}/\text{V}$ (MAX4488/MAX4489)
- Excellent DC Characteristics
 - $V_{\text{OS}} = 70\mu\text{V}$
 - $I_{\text{BIAS}} = 1\text{pA}$
 - Large-Signal Voltage Gain = 120dB
- Low-Power Shutdown Mode:
 - Reduces Supply Current to $0.01\mu\text{A}$
 - Places Output in High-Impedance State
- Available in Space-Saving SOT23, TDFN, μMAX ®, and TSSOP Packages
- AEC-Q100 Qualified, Refer to Ordering Information for the List of $/\text{V}$ Parts

Ordering Information at end of data sheet.

Typical Operating Characteristic

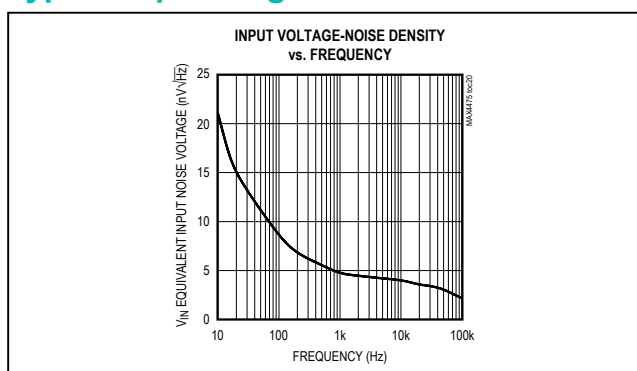

Pin Configurations and Typical Operating Circuit appear at end of data sheet.

MAX4475–MAX4478/
MAX4488/MAX4489

SOT23, Low-Noise, Low-Distortion,
Wide-Band, Rail-to-Rail Op Amps

Absolute Maximum Ratings

Power-Supply Voltage (V_{DD} to V_{SS}).....-0.3V to +6.0V
 Analog Input Voltage (IN_+ , IN_-). ($V_{SS} - 0.3V$) to ($V_{DD} + 0.3V$)
 SHDN Input Voltage($V_{SS} - 0.3V$) to +6.0V
 Output Short-Circuit Duration to Either Supply Continuous
 Continuous Input Current (IN_+ , IN_-) $\pm 10mA$
 Continuous Power Dissipation ($T_A = +70^\circ C$)
 6-Pin SOT23 (derate 5.4mW/ $^\circ C$ above +70 $^\circ C$) 431.3mW
 6-Pin TDFN (derate 18.2mW/ $^\circ C$ above 70 $^\circ C$) 1454mW
 8-Pin μ MAX (derate 4.5mW/ $^\circ C$ above +70 $^\circ C$) 362mW

8-Pin SO (derate 5.88mW/ $^\circ C$ above +70 $^\circ C$).....471mW
 14-Pin SO (derate 8.33mW/ $^\circ C$ above +70 $^\circ C$).....667mW
 14-Pin TSSOP (derate 9.1mW/ $^\circ C$ above +70 $^\circ C$).....727mW
 Operating Temperature Range -40 $^\circ C$ to +125 $^\circ C$
 Junction Temperature +150 $^\circ C$
 Storage Temperature Range -65 $^\circ C$ to +150 $^\circ C$
 Lead Temperature (soldering, 10s) +300 $^\circ C$
 Soldering Temperature (reflow) +260 $^\circ C$

Stresses beyond those listed under "Absolute Maximum Ratings" may cause permanent damage to the device. These are stress ratings only, and functional operation of the device at these or any other conditions beyond those indicated in the operational sections of the specifications is not implied. Exposure to absolute maximum rating conditions for extended periods may affect device reliability.

Package Information

SOT23-6

| PACKAGE CODE | U6F+6 |
|---|-------------------------|
| Outline Number | 21-0058 |
| Land Pattern Number | 90-0175 |
| Thermal Resistance, Single-Layer Board | |
| Junction to Ambient (θ_{JA}) | 185.5 $^\circ C/W$ |
| Junction to Case (θ_{JC}) | 75 $^\circ C/W$ |
| Thermal Resistance, Multi-Layer Board | |
| Junction to Ambient (θ_{JA}) | 134.4 $^\circ C/W$ |
| Junction to Case (θ_{JC}) | 39 $^\circ C/W$ |

μ MAX-8

| PACKAGE CODE | U8+4 |
|--|-------------------------|
| Outline Number | 21-0036 |
| Land Pattern Number | 90-0092 |
| Thermal Resistance, Multi-Layer Board | |
| Junction to Ambient (θ_{JA}) | 206 $^\circ C/W$ |
| Junction to Case (θ_{JC}) | 42 |

μ MAX-8

| PACKAGE CODE | U8+1 |
|---|-------------------------|
| Outline Number | 21-0036 |
| Land Pattern Number | 90-0092 |
| Thermal Resistance, Single-Layer Board | |
| Junction to Ambient (θ_{JA}) | 221 $^\circ C/W$ |
| Junction to Case (θ_{JC}) | 42 $^\circ C/W$ |
| Thermal Resistance, Multi-Layer Board | |
| Junction to Ambient (θ_{JA}) | 206 $^\circ C/W$ |
| Junction to Case (θ_{JC}) | 42 $^\circ C/W$ |

MAX4475–MAX4478/
MAX4488/MAX4489

SOT23, Low-Noise, Low-Distortion,
Wide-Band, Rail-to-Rail Op Amps

Package Information (continued)

TSSOP-14

| PACKAGE CODE | U14+2 |
|---|-------------------------|
| Outline Number | 21-0066 |
| Land Pattern Number | 90-0113 |
| Thermal Resistance, Single-Layer Board | |
| Junction to Ambient (θ_{JA}) | 110°C/W |
| Junction to Case (θ_{JC}) | 30°C/W |
| Thermal Resistance, Multi-Layer Board | |
| Junction to Ambient (θ_{JA}) | 100.4°C/W |
| Junction to Case (θ_{JC}) | 30°C/W |

SO-8

| PACKAGE CODE | S8+4 |
|---|-------------------------|
| Outline Number | 21-0041 |
| Land Pattern Number | 90-0096 |
| Thermal Resistance, Single-Layer Board | |
| Junction to Ambient (θ_{JA}) | 170°C/W |
| Junction to Case (θ_{JC}) | 40 |
| Thermal Resistance, Multi-Layer Board | |
| Junction to Ambient (θ_{JA}) | 132°C/W |
| Junction to Case (θ_{JC}) | 38 |

SO-14

| PACKAGE CODE | S14+4 |
|---|-------------------------|
| Outline Number | 21-0041 |
| Land Pattern Number | 90-0112 |
| Thermal Resistance, Single-Layer Board | |
| Junction to Ambient (θ_{JA}) | 120°C/W |
| Junction to Case (θ_{JC}) | 37°C/W |
| Thermal Resistance, Multi-Layer Board | |
| Junction to Ambient (θ_{JA}) | 84°C/W |
| Junction to Case (θ_{JC}) | 34°C/W |

MAX4475–MAX4478/
MAX4488/MAX4489

SOT23, Low-Noise, Low-Distortion,
Wide-Band, Rail-to-Rail Op Amps

Package Information (continued)

TDFN-6

| PACKAGE CODE | T633+2 |
|---|-------------------------|
| Outline Number | 21-0137 |
| Land Pattern Number | 90-0058 |
| Thermal Resistance, Single-Layer Board | |
| Junction to Ambient (θ_{JA}) | 55°C/W |
| Junction to Case (θ_{JC}) | 9°C/W |
| Thermal Resistance, Multi-Layer Board | |
| Junction to Ambient (θ_{JA}) | 42°C/W |
| Junction to Case (θ_{JC}) | 9°C/W |

For the latest package outline information and land patterns (footprints), go to www.maximintegrated.com/packages. Note that a “+”, “#”, or “-” in the package code indicates RoHS status only. Package drawings may show a different suffix character, but the drawing pertains to the package regardless of RoHS status.

Package thermal resistances were obtained using the method described in JEDEC specification JESD51-7, using a four-layer board. For detailed information on package thermal considerations, refer to www.maximintegrated.com/thermal-tutorial.

DC Electrical Characteristics

($V_{DD} = +5V$, $V_{SS} = 0V$, $V_{CM} = 0V$, $V_{OUT} = V_{DD}/2$, R_L tied to $V_{DD}/2$, $\overline{SHDN} = V_{DD}$, $T_A = -40^\circ\text{C}$ to $+125^\circ\text{C}$, unless otherwise noted. Typical values are at $T_A = +25^\circ\text{C}$.) (Notes 1, 2)

| PARAMETER | SYMBOL | CONDITIONS | | MIN | TYP | MAX | UNITS |
|--|------------|---|---|---------------------|-------------|---------------------|------------------------------|
| Supply Voltage Range | V_{DD} | (Note 3) | | 2.7 | | 5.5 | V |
| Quiescent Supply Current Per Amplifier | I_D | Normal mode | $V_{DD} = 3V$ | | 2.2 | | mA |
| | | | $V_{DD} = 5V$ | | 2.5 | 4.4 | |
| | | Shutdown mode ($\overline{SHDN} = V_{SS}$) (Note 2) | | | 0.01 | 1.0 | μA |
| Input Offset Voltage | V_{OS} | $T_A = +25^\circ\text{C}$ | | | ± 70 | ± 350 | μV |
| | | $T_A = -40^\circ\text{C}$ to $+125^\circ\text{C}$ | | | | ± 750 | |
| Input Offset Voltage Tempco | TC_{VOS} | | | | ± 0.3 | ± 6 | $\mu\text{V}/^\circ\text{C}$ |
| Input Bias Current | I_B | (Note 4) | | | ± 1 | ± 150 | pA |
| Input Offset Current | I_{OS} | (Note 4) | | | ± 1 | ± 150 | pA |
| Differential Input Resistance | R_{IN} | | | | 1000 | | G Ω |
| Input Common-Mode Voltage Range | V_{CM} | Guaranteed by CMRR Test | $T_A = +25^\circ\text{C}$ | -0.2 | | $V_{DD} - 1.6$ | V |
| | | | $T_A = -40^\circ\text{C}$ to $+125^\circ\text{C}$ | -0.1 | | $V_{DD} - 1.7$ | |
| Common-Mode Rejection Ratio | CMRR | $(V_{SS} - 0.2V) \leq V_{CM} \leq (V_{DD} - 1.6V)$ | $T_A = +25^\circ\text{C}$ | 90 | 115 | | dB |
| | | $(V_{SS} - 0.1V) \leq V_{CM} \leq (V_{DD} - 1.7V)$ | $T_A = -40^\circ\text{C}$ to $+125^\circ\text{C}$ | 90 | | | |
| Power-Supply Rejection Ratio | PSRR | $V_{DD} = 2.7$ to $5.5V$ | | 90 | 120 | | dB |
| Large-Signal Voltage Gain | A_{VOL} | $R_L = 10k\Omega$ to $V_{DD}/2$; $V_{OUT} = 100mV$ to $(V_{DD} - 125mV)$ | | 90 | 120 | | dB |
| | | $R_L = 1k\Omega$ to $V_{DD}/2$; $V_{OUT} = 200mV$ to $(V_{DD} - 250mV)$ | | 85 | 110 | | |
| | | $R_L = 500\Omega$ to $V_{DD}/2$; $V_{OUT} = 350mV$ to $(V_{DD} - 500mV)$ | | 85 | 110 | | |
| Output Voltage Swing | V_{OUT} | $ V_{IN+} - V_{IN-} \geq 10mV$, $R_L = 10k\Omega$ to $V_{DD}/2$ | $V_{DD} - V_{OH}$ | | 10 | 45 | mV |
| | | | $V_{OL} - V_{SS}$ | | 10 | 40 | |
| | | $ V_{IN+} - V_{IN-} \geq 10mV$, $R_L = 1k\Omega$ to $V_{DD}/2$ | $V_{DD} - V_{OH}$ | | 80 | 200 | |
| | | | $V_{OL} - V_{SS}$ | | 50 | 150 | |
| | | $ V_{IN+} - V_{IN-} \geq 10mV$, $R_L = 500\Omega$ to $V_{DD}/2$ | $V_{DD} - V_{OH}$ | | 100 | 300 | |
| | | | $V_{OL} - V_{SS}$ | | 80 | 250 | |
| Output Short-Circuit Current | I_{SC} | | | | 48 | | mA |
| Output Leakage Current | I_{LEAK} | Shutdown mode ($\overline{SHDN} = V_{SS}$), $V_{OUT} = V_{SS}$ to V_{DD} | | | ± 0.001 | ± 1.0 | μA |
| \overline{SHDN} Logic-Low | V_{IL} | | | | | $0.3 \times V_{DD}$ | V |
| \overline{SHDN} Logic-High | V_{IH} | | | $0.7 \times V_{DD}$ | | | V |
| \overline{SHDN} Input Current | | $\overline{SHDN} = V_{SS}$ to V_{DD} | | | 0.01 | 1 | μA |
| Input Capacitance | C_{IN} | | | | 10 | | pF |

AC Electrical Characteristics

($V_{DD} = +5V$, $V_{SS} = 0V$, $V_{CM} = 0V$, $V_{OUT} = V_{DD}/2$, R_L tied to $V_{DD}/2$, $\overline{SHDN} = V_{DD}$, $T_A = +25^\circ C$.)

| PARAMETER | SYMBOL | CONDITIONS | | MIN | TYP | MAX | UNITS |
|---|--------------|--|---------------|-----|--------|-----|-------------------|
| Gain-Bandwidth Product | GBWP | MAX4475–MAX4478 | $A_V = +1V/V$ | | 10 | | MHz |
| | | MAX4488/MAX4489 | $A_V = +5V/V$ | | 42 | | |
| Slew Rate | SR | MAX4475–MAX4478 | $A_V = +1V/V$ | | 3 | | V/ μs |
| | | MAX4488/MAX4489 | $A_V = +5V/V$ | | 10 | | |
| Full-Power Bandwidth (Note 5) | | MAX4475–MAX4478 | $A_V = +1V/V$ | | 0.4 | | MHz |
| | | MAX4488/MAX4489 | $A_V = +5V/V$ | | 1.25 | | |
| Peak-to-Peak Input Noise Voltage | $e_{n(P-P)}$ | f = 0.1Hz to 10Hz | | | 260 | | nV _{P-P} |
| Input Voltage-Noise Density | e_n | f = 10Hz | | | 21 | | nV/ \sqrt{Hz} |
| | | f = 1kHz | | | 4.5 | | |
| | | f = 30kHz | | | 3.5 | | |
| Input Current-Noise Density | i_n | f = 1kHz | | | 0.5 | | fA/ \sqrt{Hz} |
| Total Harmonic Distortion Plus Noise (Note 6) | THD + N | $V_{OUT} = 2V_{P-P}$, $A_V = +1V/V$ (MAX4475–MAX4478), $R_L = 10k\Omega$ to GND | f = 1kHz | | 0.0002 | | % |
| | | | f = 20kHz | | 0.0007 | | |
| | | $V_{OUT} = 2V_{P-P}$, $A_V = +1V/V$ (MAX4475–MAX4478), $R_L = 1k\Omega$ to GND | f = 1kHz | | 0.0002 | | |
| | | | f = 20kHz | | 0.001 | | |
| | | $V_{OUT} = 2V_{P-P}$, $A_V = +5V/V$ (MAX4488/ MAX4489), $R_L = 10k\Omega$ to GND | f = 1kHz | | 0.0004 | | |
| | | | f = 20kHz | | 0.0006 | | |
| Total Harmonic Distortion Plus Noise (Note 6) | THD + N | $V_{OUT} = 2V_{P-P}$, $A_V = +5V/V$ (MAX4488/MAX4489), $R_L = 1k\Omega$ to GND | f = 1kHz | | 0.0005 | | % |
| | | | f = 20kHz | | 0.008 | | |
| Capacitive-Load Stability | | No sustained oscillations | | | 200 | | pF |
| Gain Margin | GM | | | | 12 | | dB |
| Phase Margin | ϕ_M | MAX4475–MAX4478, $A_V = +1V/V$ | | | 70 | | degrees |
| | | MAX4488/MAX4489, $A_V = +5V/V$ | | | 80 | | |
| Settling Time | | To 0.01%, $V_{OUT} = 2V$ step | | | 2 | | μs |
| Delay Time to Shutdown | t_{SH} | | | | 1.5 | | μs |
| Enable Delay Time from Shutdown | t_{EN} | $V_{OUT} = 2.5V$, V_{OUT} settles to 0.1% | | | 10 | | μs |
| Power-Up Delay Time | | $V_{DD} = 0$ to 5V step, V_{OUT} stable to 0.1% | | | 13 | | μs |

Note 1: All devices are 100% tested at $T_A = +25^\circ C$. Limits over temperature are guaranteed by design.

Note 2: \overline{SHDN} is available on the MAX4475/MAX4488 only.

Note 3: Guaranteed by the PSRR test.

Note 4: Guaranteed by design.

Note 5: Full-power bandwidth for unity-gain stable devices (MAX4475–MAX4478) is measured in a closed-loop gain of +2V/V to accommodate the input voltage range, $V_{OUT} = 4V_{P-P}$.

Note 6: Lowpass-filter bandwidth is 22kHz for f = 1kHz and 80kHz for f = 20kHz. Noise floor of test equipment = $10nV/\sqrt{Hz}$.

Typical Operating Characteristics

($V_{DD} = +5V$, $V_{SS} = 0V$, $V_{CM} = 0V$, $V_{OUT} = V_{DD}/2$, R_L tied to $V_{DD}/2$, input noise floor of test equipment = $10nV/\sqrt{Hz}$ for all distortion measurements, $T_A = +25^\circ C$, unless otherwise noted.)

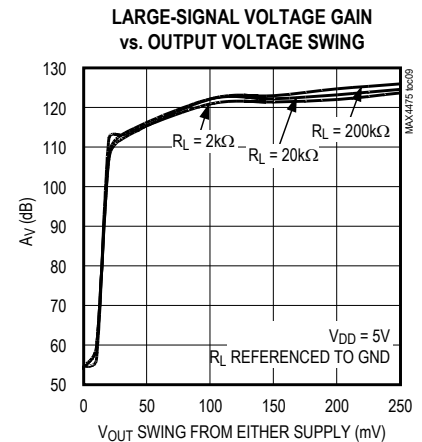
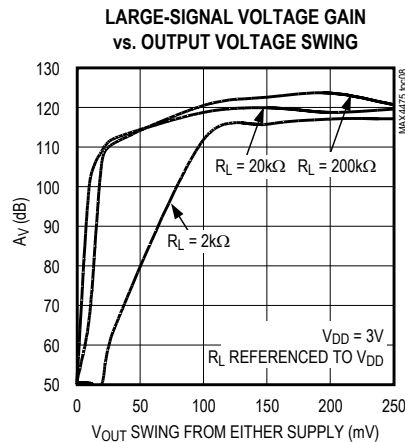
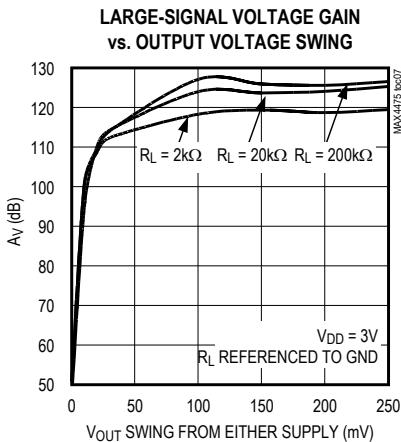
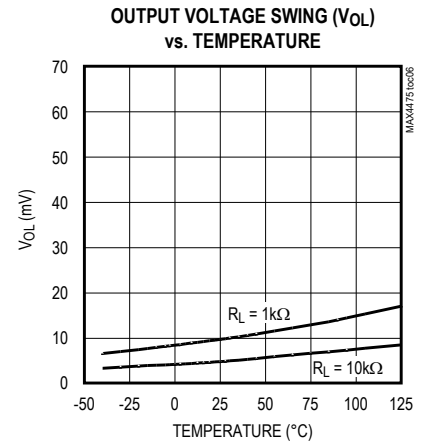
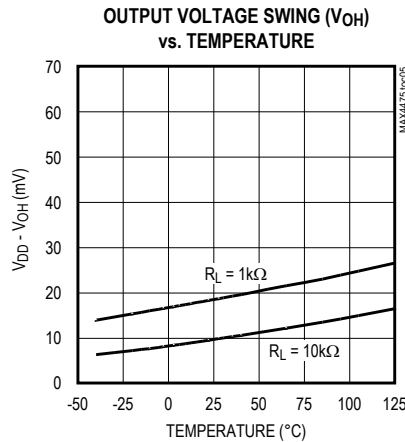
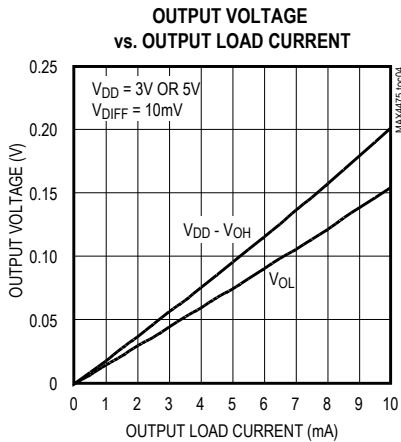
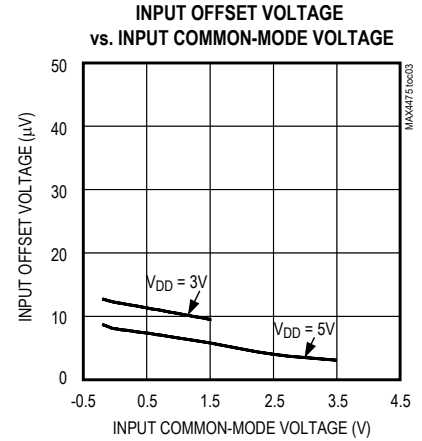
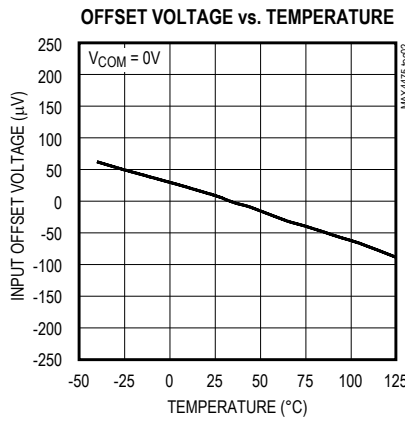
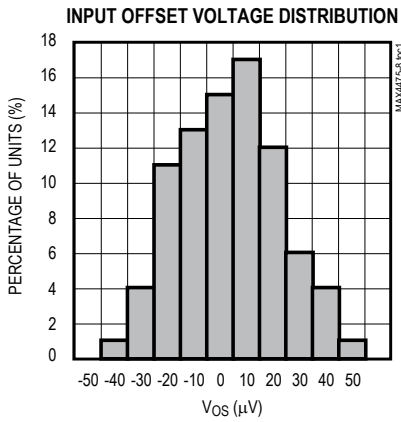

Typical Operating Characteristics (continued)

($V_{DD} = +5V$, $V_{SS} = 0V$, $V_{CM} = 0V$, $V_{OUT} = V_{DD}/2$, R_L tied to $V_{DD}/2$, input noise floor of test equipment = $10nV/\sqrt{Hz}$ for all distortion measurements, $T_A = +25^\circ C$, unless otherwise noted.)

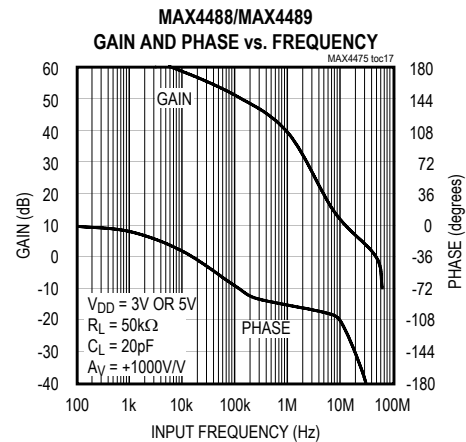
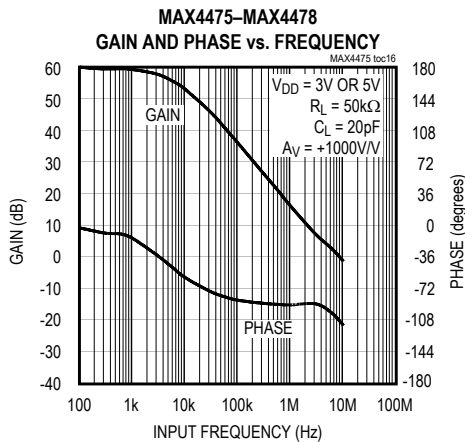
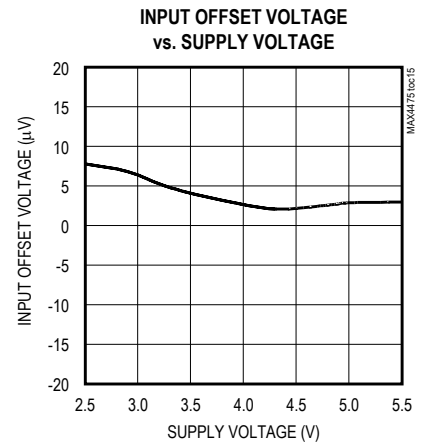
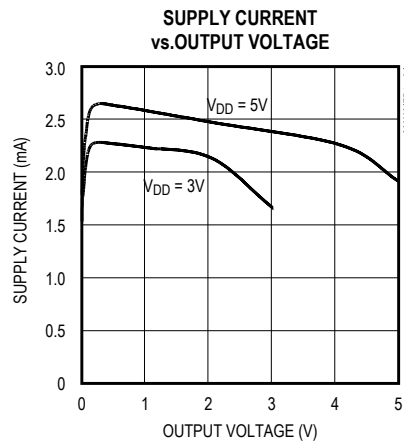
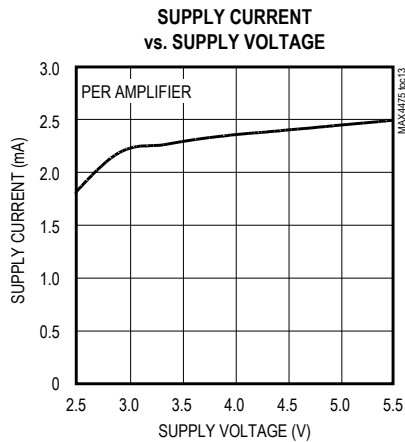
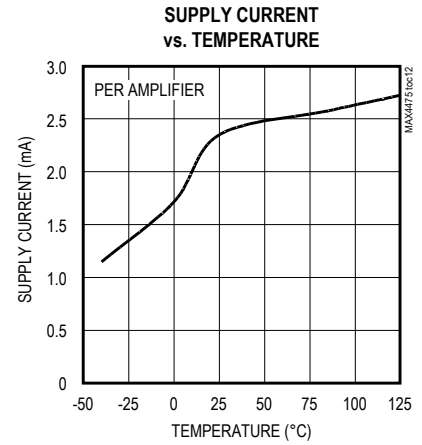
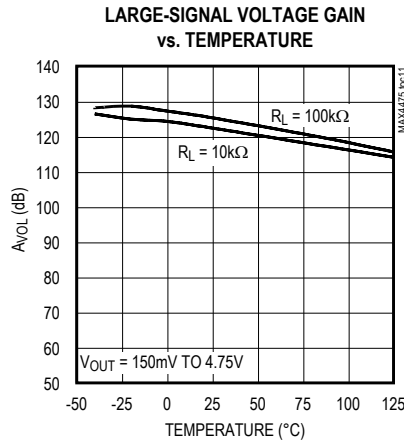
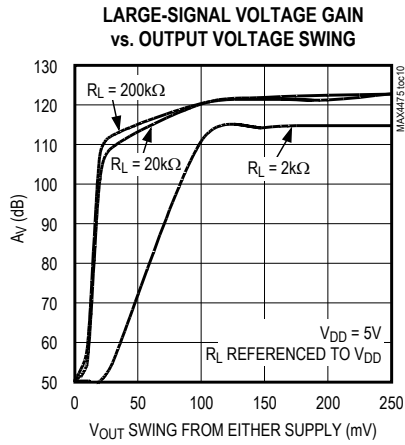

MAX4475–MAX4478/
MAX4488/MAX4489

SOT23, Low-Noise, Low-Distortion,
Wide-Band, Rail-to-Rail Op Amps

Typical Operating Characteristics (continued)

($V_{DD} = +5V$, $V_{SS} = 0V$, $V_{CM} = 0V$, $V_{OUT} = V_{DD}/2$, R_L tied to $V_{DD}/2$, input noise floor of test equipment = $10nV/\sqrt{Hz}$ for all distortion measurements, $T_A = +25^\circ C$, unless otherwise noted.)

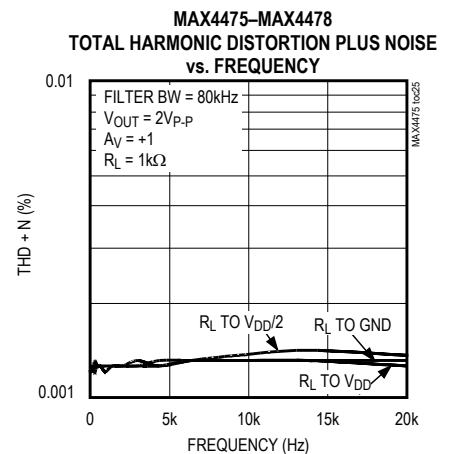
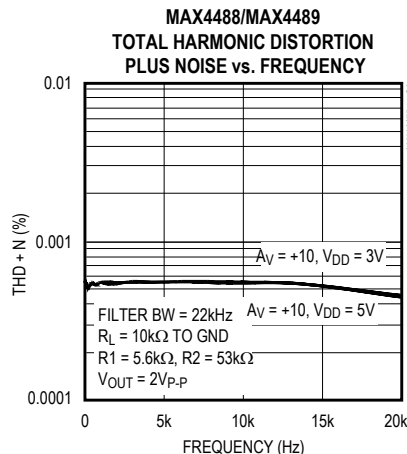
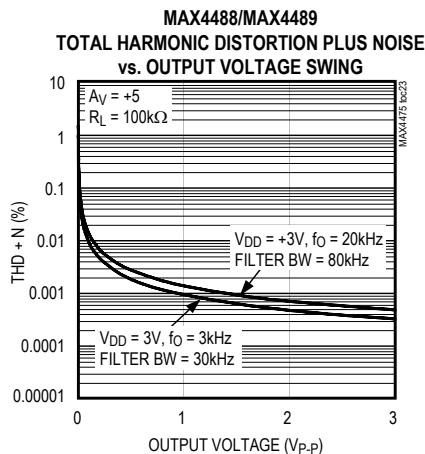
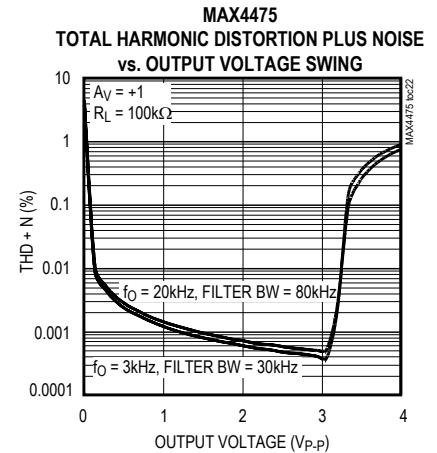
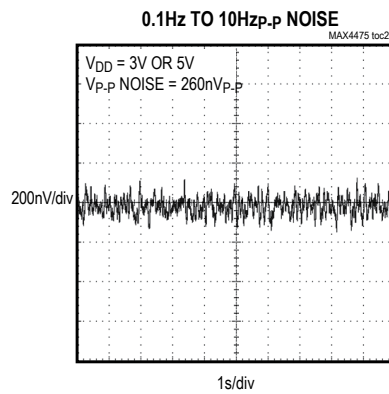
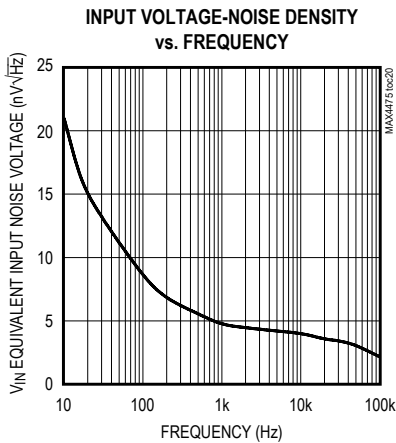
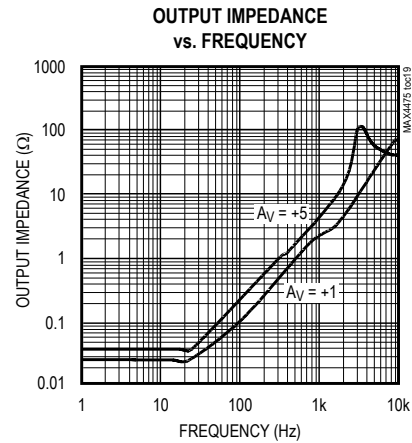
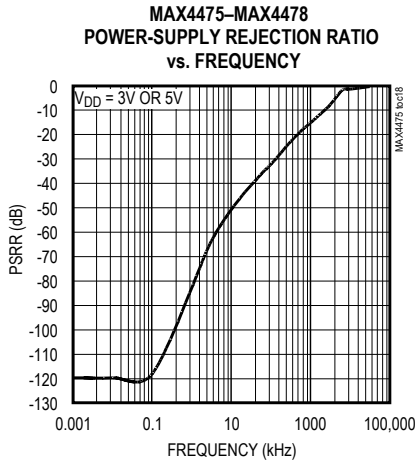

Typical Operating Characteristics (continued)

($V_{DD} = +5V$, $V_{SS} = 0V$, $V_{CM} = 0V$, $V_{OUT} = V_{DD}/2$, R_L tied to $V_{DD}/2$, input noise floor of test equipment = $10nV/\sqrt{Hz}$ for all distortion measurements, $T_A = +25^\circ C$, unless otherwise noted.)

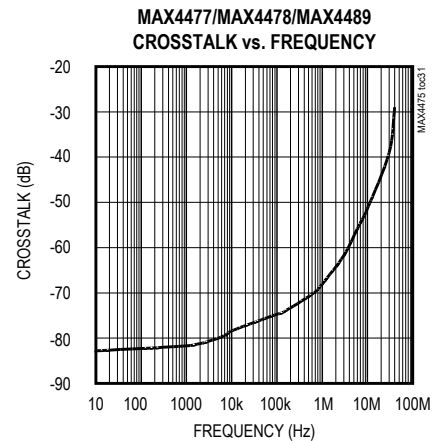
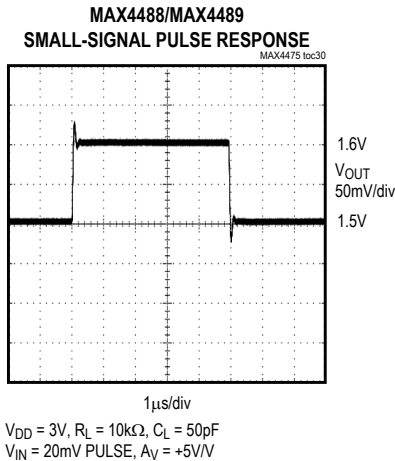
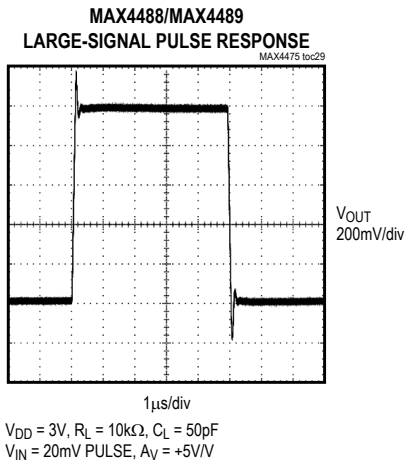
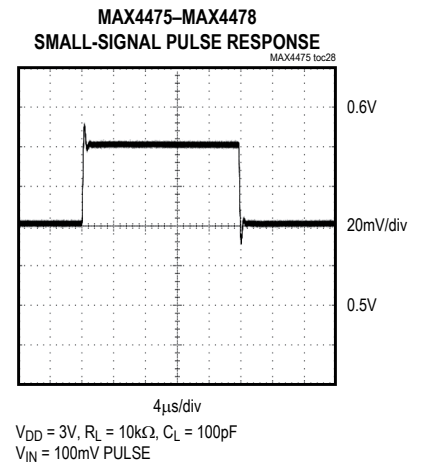
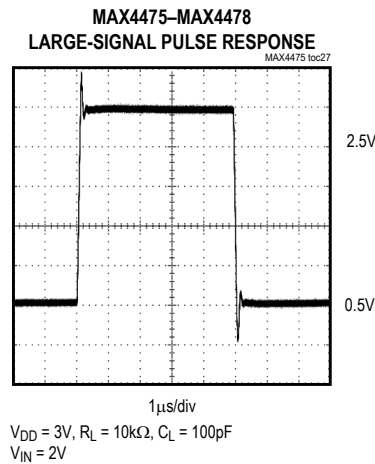
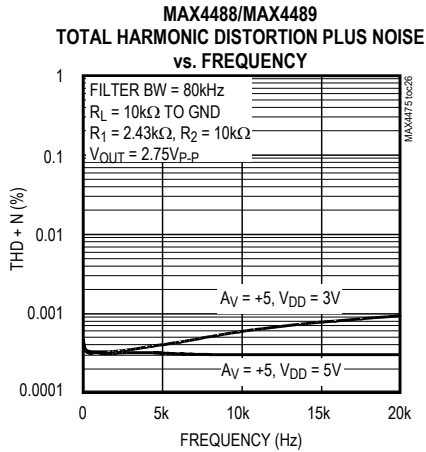

Pin Description

| PIN | | | | | NAME | FUNCTION |
|---------------------|---------------------|------------|---------------------|--------------|-----------------------------------|--|
| MAX4475/ MAX4488 | MAX4475/ MAX4488 | MAX4476 | MAX4477/ MAX4489 | MAX4478 | | |
| SOT23/TDFN | SO/ μ MAX | SOT23/TDFN | SO/ μ MAX | SO/TSSOP | | |
| 1 | 6 | 1 | 1, 7 | 1, 7, 8, 14 | OUT, OUTA, OUTB, OUTC, OUTD | Amplifier Output |
| 2 | 4 | 2 | 4 | 11 | V _{SS} | Negative Supply. Connect to ground for single-supply operation |
| 3 | 3 | 3 | 3, 5 | 3, 5, 10, 12 | IN+, INA+, INB+, INC+, IND+ | Noninverting Amplifier Input |
| 4 | 2 | 4 | 2, 6 | 2, 6, 9, 13 | IN-, INA-, INB-, INC-, IND- | Inverting Amplifier Input |
| 6 | 7 | 6 | 8 | 4 | V _{DD} | Positive Supply |
| 5 | 8 | — | — | — | $\overline{\text{SHDN}}$ | Shutdown Input. Connect to V _{DD} for normal operation (amplifier(s) enabled). |
| — | 1, 5 | 5 | — | — | N.C. | No Connection. Not internally connected. |
| EP | — | EP | — | — | EP | Exposed Paddle (TDFN Only). Connect to V _{SS} . |

Detailed Description

The MAX4475–MAX4478/MAX4488/MAX4489 single-supply operational amplifiers feature ultra-low noise and distortion. Their low distortion and low noise make them ideal for use as preamplifiers in wide dynamic-range applications, such as 16-bit analog-to-digital converters (see *Typical Operating Circuit*). Their high-input impedance and low noise are also useful for signal conditioning of high-impedance sources, such as piezoelectric transducers.

These devices have true rail-to-rail output operation, drive loads as low as $1\text{k}\Omega$ while maintaining DC accuracy, and can drive capacitive loads up to 200pF without oscillation. The input common-mode voltage range extends from $(V_{DD} - 1.6\text{V})$ to 200mV below the negative rail. The push-pull output stage maintains excellent DC characteristics, while delivering up to $\pm 5\text{mA}$ of current.

The MAX4475–MAX4478 are unity-gain stable, while the MAX4488/MAX4489 have a higher slew rate and are stable for gains $\geq 5\text{V/V}$. The MAX4475/MAX4488 feature a low-power shutdown mode, which reduces the supply current to $0.01\mu\text{A}$ and disables the outputs.

Low Distortion

Many factors can affect the noise and distortion that the device contributes to the input signal. The following guidelines offer valuable information on the impact of design choices on Total Harmonic Distortion (THD).

Choosing proper feedback and gain resistor values for a particular application can be a very important factor in reducing THD. In general, the smaller the closed-loop gain, the smaller the THD generated, especially when driving heavy resistive loads. The THD of the part normally increases at approximately 20dB per decade, as a function of frequency. Operating the device near or above the full-power bandwidth significantly degrades distortion.

Referencing the load to either supply also improves the part's distortion performance, because only one of the MOSFETs of the push-pull output stage drives the output. Referencing the load to midsupply increases the part's distortion for a given load and feedback setting. (See the Total Harmonic Distortion vs. Frequency graph in the *Typical Operating Characteristics*.)

For gains $\geq 5\text{V/V}$, the decompensated devices MAX4488/MAX4489 deliver the best distortion performance, since they have a higher slew rate and provide a higher amount of loop gain for a given closed-loop gain setting. Capacitive loads below 100pF do not significantly affect distortion results. Distortion performance is relatively constant over supply voltages.

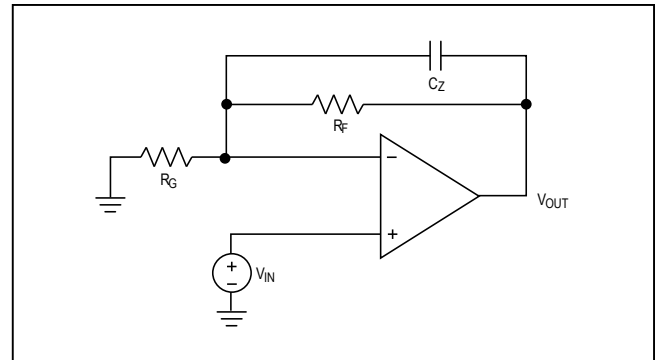

Figure 1. Adding Feed-Forward Compensation

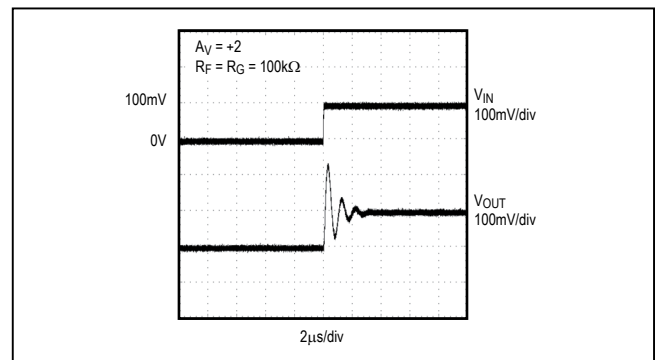

Figure 2a. Pulse Response with No Feed-Forward Compensation

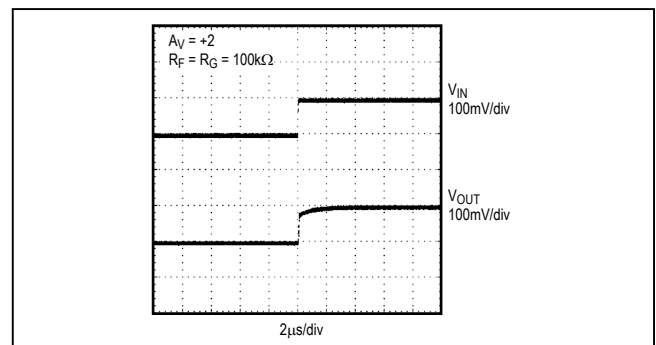

Figure 2b. Pulse Response with 10pF Feed-Forward Compensation

Low Noise

The amplifier's input-referred noise-voltage density is dominated by flicker noise at lower frequencies, and by thermal noise at higher frequencies. Because the thermal noise contribution is affected by the parallel combination of the feedback resistive network ($R_F \parallel R_G$, Figure 1), these resistors should be reduced in cases where the system bandwidth is large and thermal noise is dominant. This noise contribution factor decreases, however, with increasing gain settings.

For example, the input noise-voltage density of the circuit with $R_F = 100\text{k}\Omega$, $R_G = 11\text{k}\Omega$ ($A_V = +5\text{V/V}$) is $e_n = 14\text{nV}/\sqrt{\text{Hz}}$, e_n can be reduced to $6\text{nV}/\sqrt{\text{Hz}}$ by choosing $R_F = 10\text{k}\Omega$, $R_G = 1.1\text{k}\Omega$ ($A_V = +5\text{V/V}$), at the expense of greater current consumption and potentially higher distortion. For a gain of 100V/V with $R_F = 100\text{k}\Omega$, $R_G = 1.1\text{k}\Omega$, the e_n is still a low $6\text{nV}/\sqrt{\text{Hz}}$.

Using a Feed-Forward Compensation Capacitor, C_Z

The amplifier's input capacitance is 10pF . If the resistance seen by the inverting input is large (feedback network), this can introduce a pole within the amplifier's bandwidth resulting in reduced phase margin. Compensate the reduced phase margin by introducing a feed-forward capacitor (C_Z) between the inverting input and the output (Figure 1). This effectively cancels the pole from the inverting input of the amplifier. Choose the value of C_Z as follows:

$$C_Z = 10 \times (R_F / R_G) \text{ [pF]}$$

In the unity-gain stable MAX4475–MAX4478, the use of a proper C_Z is most important for $A_V = +2\text{V/V}$, and $A_V = -1\text{V/V}$. In the decompensated MAX4488/MAX4489, C_Z is most important for $A_V = +10\text{V/V}$. Figures 2a and 2b show transient response both with and without C_Z .

Using a slightly smaller C_Z than suggested by the formula above achieves a higher bandwidth at the expense of reduced phase and gain margin. As a general guideline, consider using C_Z for cases where $R_G \parallel R_F$ is greater than $20\text{k}\Omega$ (MAX4475–MAX4478) or greater than $5\text{k}\Omega$ (MAX4488/MAX4489).

Applications Information

The MAX4475–MAX4478/MAX4488/MAX4489 combine good driving capability with ground-sensing input and rail-to-rail output operation. With their low distortion and low noise, they are ideal for use in ADC buffers, medical instrumentation systems and other noise-sensitive applications.

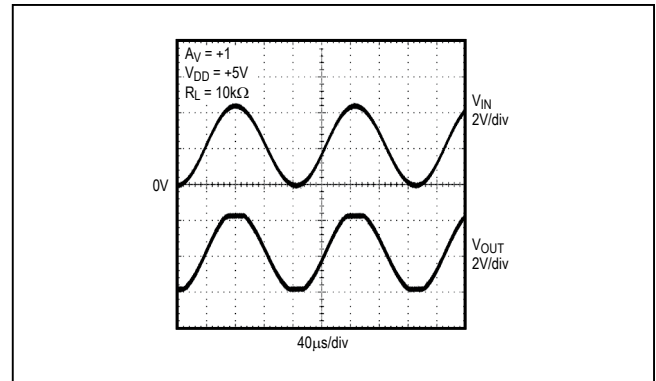

Figure 3. Overdriven Input Showing No Phase Reversal

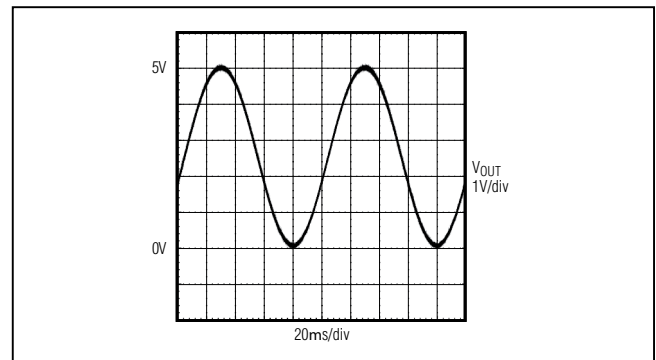

Figure 4. Rail-to-Rail Output Operation

Ground-Sensing and Rail-to-Rail Outputs

The common-mode input range of these devices extends below ground, and offers excellent common-mode rejection. These devices are guaranteed not to undergo phase reversal when the input is overdriven (Figure 3).

Figure 4 showcases the true rail-to-rail output operation of the amplifier, configured with $A_V = 5\text{V/V}$. The output swings to within 8mV of the supplies with a $10\text{k}\Omega$ load, making the devices ideal in low-supply voltage applications.

Power Supplies and Layout

The MAX4475–MAX4478/MAX4488/MAX4489 operate from a single $+2.7\text{V}$ to $+5.5\text{V}$ power supply or from dual supplies of $\pm 1.35\text{V}$ to $\pm 2.75\text{V}$. For single-supply operation, bypass the power supply with a $0.1\mu\text{F}$ ceramic

Typical Application Circuit

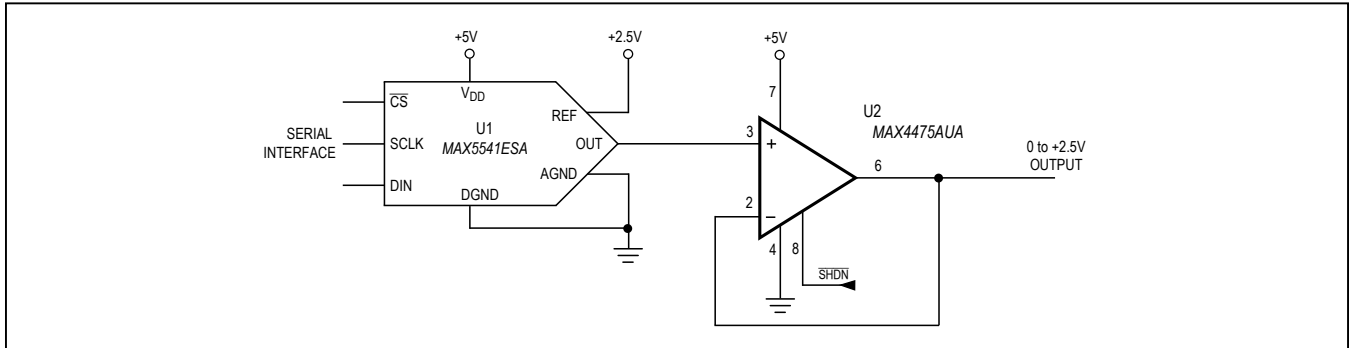

Typical Operating Circuit

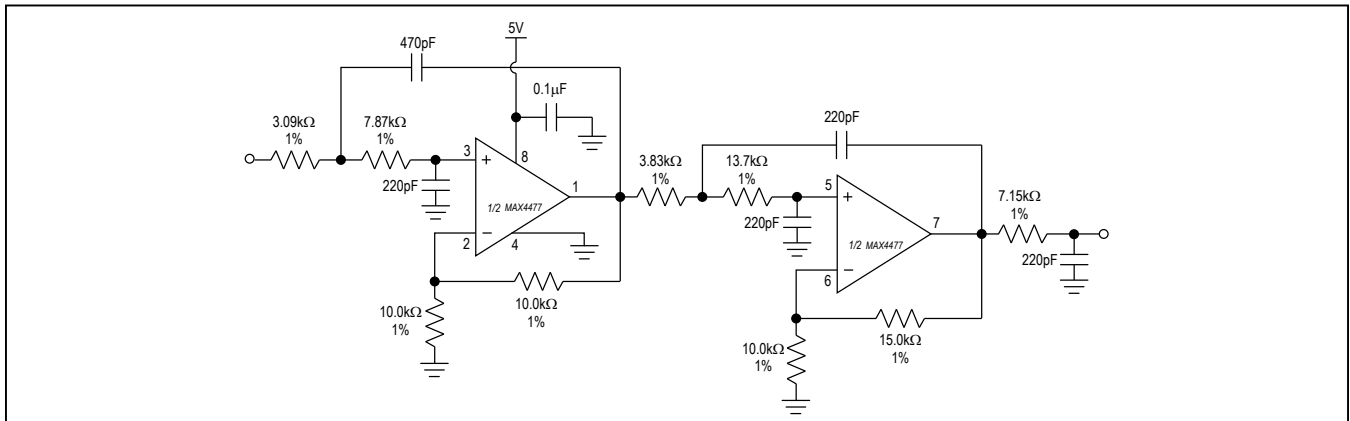

capacitor placed close to the V_{DD} pin. If operating from dual supplies, bypass each supply to ground.

Good layout improves performance by decreasing the amount of stray capacitance and noise at the op amp's inputs and output. To decrease stray capacitance, minimize PC board trace lengths and resistor leads, and place external components close to the op amp's pins.

Typical Application Circuit

The *Typical Application Circuit* shows the single MAX4475 configured as an output buffer for the MAX5541 16-bit DAC. Because the MAX5541 has an unbuffered voltage output, the input bias current of the op amp used must be less than 6nA to maintain 16-bit accuracy. The MAX4475 has an input bias current of only 150pA (max), virtually eliminating this as a source

of error. In addition, the MAX4475 has excellent open-loop gain and common-mode rejection, making this an excellent output buffer amplifier.

DC-Accurate Lowpass Filter

The MAX4475–MAX4478/MAX4488/MAX4489 offer a unique combination of low noise, wide bandwidth, and high gain, making them an excellent choice for active filters up to 1MHz. The *Typical Operating Circuit* shows the dual MAX4477 configured as a 5th order Chebyshev filter with a cutoff frequency of 100kHz. The circuit is implemented in the Sallen-Key topology, making this a DC-accurate filter.

Pin Configurations

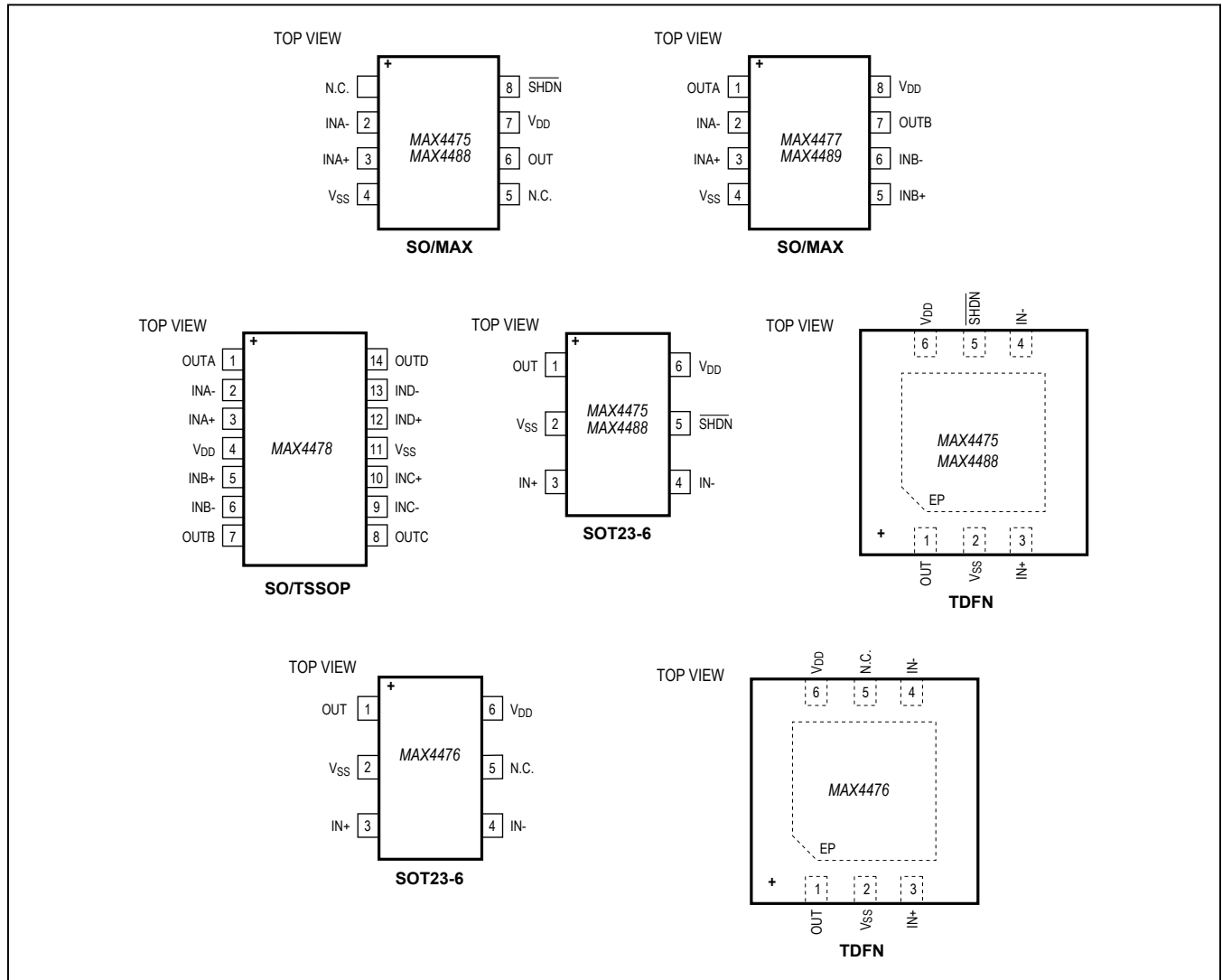

MAX4475–MAX4478/
MAX4488/MAX4489

SOT23, Low-Noise, Low-Distortion,
Wide-Band, Rail-to-Rail Op Amps

Ordering Information

| PART | TEMP RANGE | PIN-PACKAGE | TOP MARK |
|----------------------|-----------------|-------------|----------|
| MAX4475 AUT+T | -40°C to +125°C | 6 SOT23 | AAZV |
| MAX4475AUA+ | -40°C to +125°C | 8 μMAX | — |
| MAX4475ASA+ | -40°C to +125°C | 8 SO | — |
| MAX4475ATT+T | -40°C to +125°C | 6 TDFN-EP* | +ADD |
| MAX4475AUT/V+T | -40°C to +125°C | 6 SOT23 | +ACQQ |
| MAX4476 AUT+T | -40°C to +125°C | 6 SOT23 | AAZX |
| MAX4476ATT+T | -40°C to +125°C | 6 TDFN-EP* | +ADF |
| MAX4477 AUA+ | -40°C to +125°C | 8 μMAX | — |
| MAX4477AUA+ | -40°C to +125°C | 8 μMAX | — |
| MAX4477AUA/V+T* | -40°C to +125°C | 8 μMAX | +AA/V |
| MAX4477ASA+ | -40°C to +125°C | 8 SO | — |
| MAX4478 AUD+ | -40°C to +125°C | 14 TSSOP | — |
| MAX4478AUD/V+ | -40°C to +125°C | 14 TSSOP | — |
| MAX4478ASD+ | -40°C to +125°C | 14 SO | — |
| MAX4488 AUT+T | -40°C to +125°C | 6 SOT23 | AAZW |
| MAX4488AUA+ | -40°C to +125°C | 8 μMAX | — |
| MAX4488ASA+ | -40°C to +125°C | 8 SO | — |
| MAX4488ATT+T | -40°C to +125°C | 6 TDFN-EP* | +ADE |
| MAX4489 AUA+ | -40°C to +125°C | 8 μMAX | — |
| MAX4489AUA/V+T | -40°C to +125°C | 8 μMAX | — |
| MAX4489ASA+ | -40°C to +125°C | 8 SO | — |

+Denotes a lead(Pb)-free/RoHS-compliant package.

*EP = Exposed pad (connect to V_{SS}).

**Future product—Contact Maxim for availability.

/V denotes an automotive qualified part.

T = Tape and reel.

Chip Information

PROCESS: BiCMOS

Selector Guide

| PART | GAIN BW (MHz) | STABLE GAIN (V/V) | NO. OF AMPS | SHDN |
|---------|---------------|-------------------|-------------|------|
| MAX4475 | 10 | 1 | 1 | Yes |
| MAX4476 | 10 | 1 | 1 | — |
| MAX4477 | 10 | 1 | 2 | — |
| MAX4478 | 10 | 1 | 4 | — |
| MAX4488 | 42 | 5 | 1 | Yes |
| MAX4489 | 42 | 5 | 2 | — |

Revision History

| REVISION NUMBER | REVISION DATE | DESCRIPTION | PAGES CHANGED |
|-----------------|---------------|--|---------------|
| 4 | 12/09 | Added lead-free designations and an automotive part to the Ordering Information and added input current spec in Absolute Maximum Ratings section | 1, 2, 13 |
| 5 | 7/10 | Added <i>IV</i> designation to the MAX4475 product and soldering temperature | 1, 2 |
| 6 | 6/12 | Added <i>IV</i> designation for MAX4489. | 13 |
| 7 | 1/18 | Added AEC statement to <i>Features</i> section | 1 |
| 8 | 7/18 | Updated <i>Ordering Information</i> table | 14 |
| 9 | 7/18 | Updated <i>Absolute Maximum Rating</i> and <i>Package Information</i> | 2, 14 |
| 10 | 8/18 | Updated <i>Package Information</i> section | 2–4 |
| 11 | 4/19 | Updated <i>General Description</i> and <i>Ordering Information</i> section | 1, 16 |

For pricing, delivery, and ordering information, please visit Maxim Integrated's online storefront at <https://www.maximintegrated.com/en/storefront/storefront.html>.

Maxim Integrated cannot assume responsibility for use of any circuitry other than circuitry entirely embodied in a Maxim Integrated product. No circuit patent licenses are implied. Maxim Integrated reserves the right to change the circuitry and specifications without notice at any time. The parametric values (min and max limits) shown in the Electrical Characteristics table are guaranteed. Other parametric values quoted in this data sheet are provided for guidance.

Looking for pricing, stock, or lifecycle information?

Click below to explore more details on WIN SOURCE:

- ⊖ [View MAX4488AUT+T on WIN SOURCE](#)
- ⊖ [Maxim Integrated Information](#)

Optimize Your Supply Chain with WIN SOURCE Solutions

- ✓ Global Sourcing Solution
- ✓ Obsolete Management
- ✓ Cost Control Management
- ✓ Shortage Management
- ✓ Alternative Solution
- ✓ Excess Inventory Management