

MAX4484/MAX4486/ MAX4487

Single/Dual/Quad, Low-Cost, Single-Supply 7MHz, Rail-to-Rail Op Amps

General Description

The MAX4484/MAX4486/MAX4487 single/dual/quad low-cost general-purpose op amps operate from a single +2.7V to +5.5V supply. The op amps are unity-gain stable with a 7MHz gain-bandwidth product, capable of driving an external 2kΩ load with rail-to-rail output swing. The amplifiers are stable with capacitive loads of up to 100pF. The MAX4484/MAX4486/MAX4487 are specified from -40°C to +125°C, making them suitable for a variety of harsh environments.

The single MAX4484 is available in the ultra-small 5-pin SC70, while the dual MAX4486 is packaged in the space-saving 8-pin SOT23 and μMAX® packages. The quad MAX4487 is available in the 14-pin SO and TSSOP packages.

Applications

- Single-Supply Zero-Crossing Detector
- Instruments and Terminals
- Portable Communicators
- Electronic Ignition Modules
- Infrared Receivers for Remote Controls
- Sensor Signal Detection

μMAX is a registered trademark of Maxim Integrated Products, Inc..

Pin Configurations/Functional Diagrams

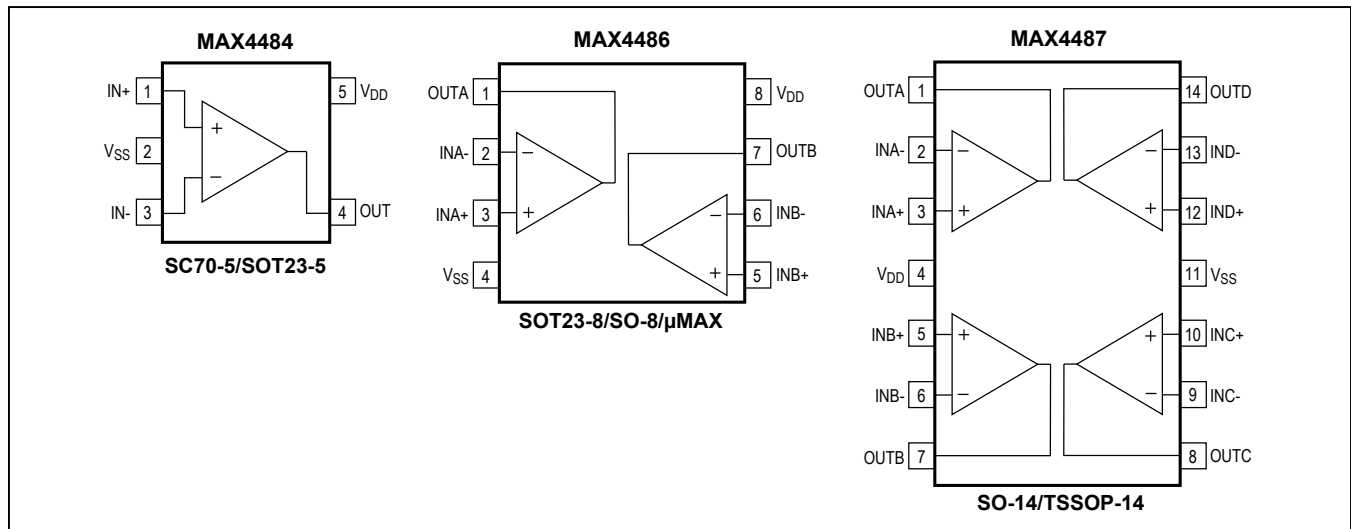

Features

- 7MHz Unity-Gain Stable Bandwidth
- Stable for Capacitive Loads Up to 100pF
- +2.7V to +5.5V Single-Supply Voltage Range
- Ground-Sensing Inputs
- Outputs Swing Rail-to-Rail
- No Phase Reversal for Overdriven Inputs
- 85dB AVOL with 2kΩ Load
- 0.01% THD with 2kΩ Load
- Available in Space-Saving Packages
 - 5-Pin SC70 (MAX4484)
 - 8-Pin SOT23 (MAX4486)

Ordering Information

PART	TEMP RANGE	PIN-PACKAGE	TOP MARK
MAX4484AXK-T	-40°C to +125°C	5 SC70-5	ABQ
MAX4484AUK-T	-40°C to +125°C	5 SOT23-5	ADPE
MAX4486AKA-T	-40°C to +125°C	8 SOT23-8	AAEP
MAX4486ASA	-40°C to +125°C	8 SO	—
MAX4486AUA	-40°C to +125°C	8 μMAX	—
MAX4487AUD	-40°C to +125°C	14 TSSOP	—
MAX4487ASD	-40°C to +125°C	14 SO	—

Absolute Maximum Ratings

Power Supply Voltage (V_{DD} to V_{SS}).....	-0.3V to +6V	8-Pin μ MAX (derate 4.5mW/°C above +70°C).....	362mW
All Other Pins	($V_{SS} - 0.3V$) to ($V_{DD} + 0.3V$)	14-Pin TSSOP (derate 9.1mW/°C above +70°C).....	727mW
Output Short-Circuit Duration (OUT shorted to V_{DD} or V_{SS})	Continuous	14-Pin SO (derate 8.33mW/°C above +70°C).....	667mW
Continuous Power Dissipation ($T_A = +70^\circ\text{C}$)		Operating Temperature Range.....	-55°C to +125°C
5-Pin SC70 (derate 3.1mW/°C above +70°C).....	247mW	Junction Temperature.....	+150°C
5-Pin SOT23 (derate 7.1mW/°C above +70°C)	571mW	Storage Temperature Range.....	-65°C to +150°C
8-Pin SOT23 (derate 9.1mW/°C above +70°C)	727mW	Lead Temperature (soldering, 10s)	+300°C
8-Pin SO (derate 5.88mW/°C above +70°C).....	471mW		

Stresses beyond those listed under "Absolute Maximum Ratings" may cause permanent damage to the device. These are stress ratings only, and functional operation of the device at these or any other conditions beyond those indicated in the operational sections of the specifications is not implied. Exposure to absolute maximum rating conditions for extended periods may affect device reliability.

Electrical Characteristics— $T_A = +25^\circ\text{C}$

($V_{DD} = +5.0V$, $V_{SS} = 0V$, $V_{CM} = 0V$, $V_{OUT} = V_{DD}/2$, $R_L = \infty$ to $V_{DD}/2$, unless otherwise noted.)

PARAMETER	SYMBOL	CONDITIONS	MIN	TYP	MAX	UNITS
Supply Voltage Range	V_{DD}	Inferred from PSRR test	2.7		5.5	V
Supply Current per Amplifier	I_{DD}	$V_{DD} = +2.7V$		1.9		mA
		$V_{DD} = +5.0V$		2.2	3.5	
Input Offset Voltage	V_{OS}	MAX4484		± 0.3	± 5.0	mV
		MAX4486		± 0.3	± 7.0	
		MAX4487		± 0.3	± 9.0	
Input Bias Current	I_B	(Note 1)		± 0.1	100	pA
Input Offset Current	I_{OS}	(Note 1)		± 0.1	100	pA
Input Resistance	R_{IN}	Differential or common mode		1000		G Ω
Input Common-Mode Voltage Range	V_{CM}	Inferred from CMRR test	V_{SS}		$V_{DD} - 1.3$	V
Common-Mode Rejection Ratio	CMRR	$V_{SS} \leq V_{CM} \leq V_{DD} - 1.3V$	67	83		dB
Power-Supply Rejection Ratio	PSRR	$+2.7V \leq V_{DD} \leq +5.5V$	70	85		dB
Large-Signal Voltage Gain	A_{VOL}	$V_{SS} + 0.3V \leq V_{OUT} \leq V_{DD} - 0.3V$, $R_L = 1k\Omega$	$R_L = 100k\Omega$		98	dB
			$R_L = 2k\Omega$	76	85	
Output Voltage High	V_{OH}	Specified as $ V_{DD} - V_{OH} $	$R_L = 100k\Omega$		3	mV
			$R_L = 2k\Omega$		15	
Output Voltage Low	V_{OL}	Specified as $ V_{OL} - V_{SS} $	$R_L = 100k\Omega$		1	mV
			$R_L = 2k\Omega$		20	
Output Short-Circuit Current	I_{SC}	Sourcing		27		mA
		Sinking		33		
Gain-Bandwidth Product	GBW			7		MHz
Phase Margin	ϕ_m			55		degrees
Gain Margin	Gm			12		dB
Slew Rate	SR			20		V/ μ s

Electrical Characteristics— $T_A = +25^\circ\text{C}$

($V_{DD} = +5.0\text{V}$, $V_{SS} = 0\text{V}$, $V_{CM} = 0\text{V}$, $V_{OUT} = V_{DD}/2$, $R_L = \infty$ to $V_{DD}/2$, unless otherwise noted.)

PARAMETER	SYMBOL	CONDITIONS	MIN	TYP	MAX	UNITS
Input Voltage-Noise Density	e_n	$f = 10\text{kHz}$		29		$\text{nV}/\sqrt{\text{Hz}}$
Input Current-Noise Density	i_n	$f = 10\text{kHz}$		1		$\text{fA}/\sqrt{\text{Hz}}$
Capacitive-Load Stability	C_{LOAD}	$A_V = +1\text{V/V}$ (Note 1)	100			pF
Power-On Time	t_{ON}			1		μs
Input Capacitance	C_{IN}			2		pF
Total Harmonic Distortion	THD	$f = 10\text{kHz}$, $V_{OUT} = 2V_{P-P}$, $A_V = +1\text{V/V}$	$R_L = 100\text{k}\Omega$	0.006		%
			$R_L = 2\text{k}\Omega$	0.01		
Settling Time to 0.01%	t_S	$V_{OUT} = 4\text{V}$ step, $A_V = +1\text{V/V}$		450		ns

Electrical Characteristics— $T_A = -40^\circ\text{C}$ to $+125^\circ\text{C}$

($V_{DD} = +5.0\text{V}$, $V_{SS} = 0\text{V}$, $V_{CM} = 0\text{V}$, $V_{OUT} = V_{DD}/2$, $R_L = \infty$ to $V_{DD}/2$, unless otherwise noted.) (Note 2)

PARAMETER	SYMBOL	CONDITIONS	MIN	TYP	MAX	UNITS
Supply Voltage Range	V_{DD}	Inferred from PSRR test	2.7		5.5	V
Supply Current per Amplifier	I_{DD}				4.0	mA
Input Offset Voltage	V_{OS}	MAX4484			± 8.5	mV
		MAX4486			± 10.0	
		MAX4487			± 11.0	
Input Offset Voltage Drift	TC_{VOS}			± 6		$\mu\text{V}/^\circ\text{C}$
Input Bias Current	I_B	(Note 1)			± 100	pA
Input Offset Current	I_{OS}	(Note 1)			± 100	pA
Input Common-Mode Voltage Range	V_{CM}	Inferred from CMRR test	V_{SS}		$V_{DD} - 1.4$	V
Common-Mode Rejection Ratio	CMRR	$V_{SS} \leq V_{CM} \leq V_{DD} - 1.4\text{V}$	$T_A = -40^\circ\text{C}$ to $+85^\circ\text{C}$	65		dB
			$T_A = -40^\circ\text{C}$ to $+125^\circ\text{C}$	62		
Power-Supply Rejection Ratio	PSRR	$+2.7\text{V} \leq V_{DD} \leq +5.5\text{V}$	$T_A = -40^\circ\text{C}$ to $+85^\circ\text{C}$	67		dB
			$T_A = -40^\circ\text{C}$ to $+125^\circ\text{C}$	64		
Large-Signal Voltage Gain	A_{VOL}	$V_{SS} + 0.3\text{V} \leq V_{OUT} \leq V_{DD} - 0.3\text{V}$, $R_L = 2\text{k}\Omega$	$T_A = -40^\circ\text{C}$ to $+85^\circ\text{C}$	66		dB
			$T_A = -40^\circ\text{C}$ to $+125^\circ\text{C}$	62		
Output Voltage High	V_{OH}	$ V_{DD} - V_{OUT} $, $R_L = 2\text{k}\Omega$	$T_A = -40^\circ\text{C}$ to $+85^\circ\text{C}$	100		mV
			$T_A = -40^\circ\text{C}$ to $+125^\circ\text{C}$	100		
Output Voltage Low	V_{OL}	$ V_{OUT} - V_{SS} $, $R_L = 2\text{k}\Omega$	$T_A = -40^\circ\text{C}$ to $+85^\circ\text{C}$	100		mV
			$T_A = -40^\circ\text{C}$ to $+125^\circ\text{C}$	250		

Note 1: Guaranteed by design.

Note 2: Specifications are 100% tested at $T_A = +25^\circ\text{C}$ (exceptions marked). All temperature limits are guaranteed by design.

Typical Operating Characteristics

($V_{DD} = +5V$, $V_{SS} = 0V$, $V_{CM} = V_{DD}/2$, $R_L = \infty$ to $V_{DD}/2$, unless otherwise noted.)

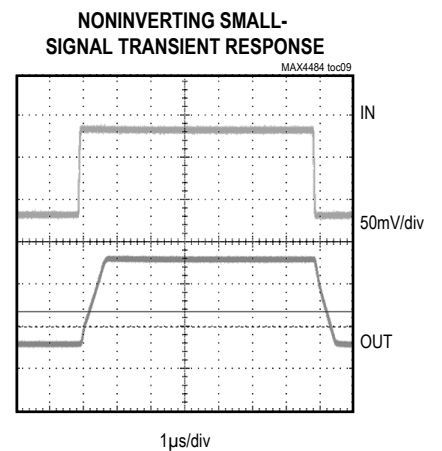
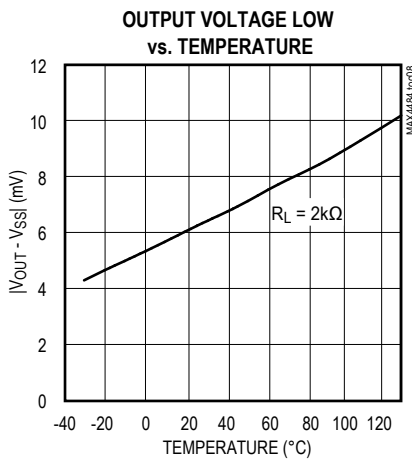
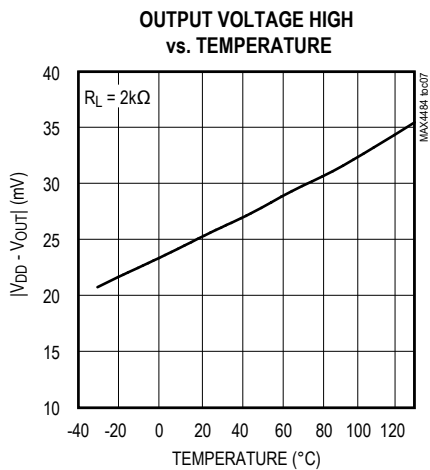
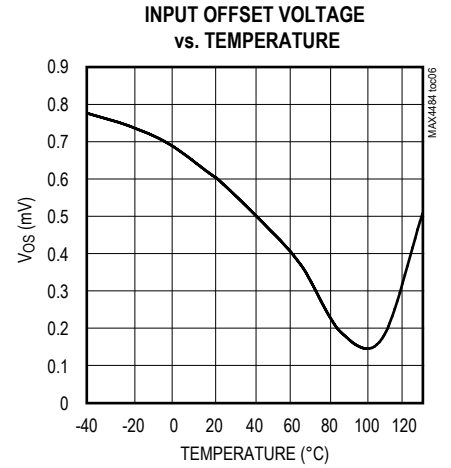
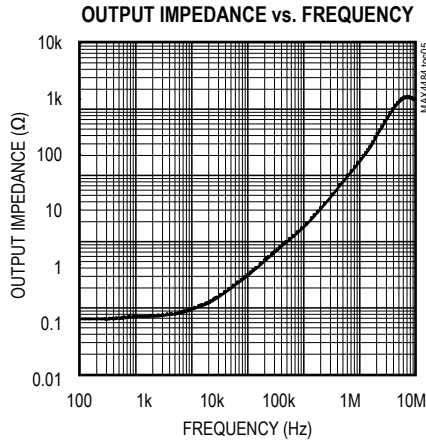
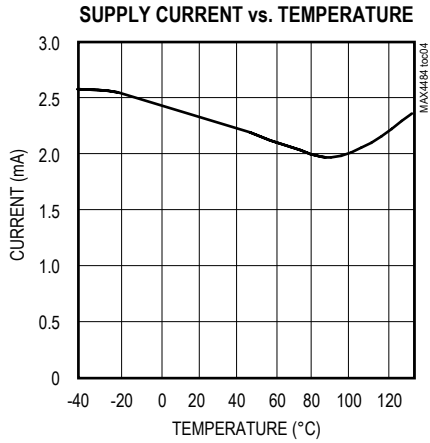
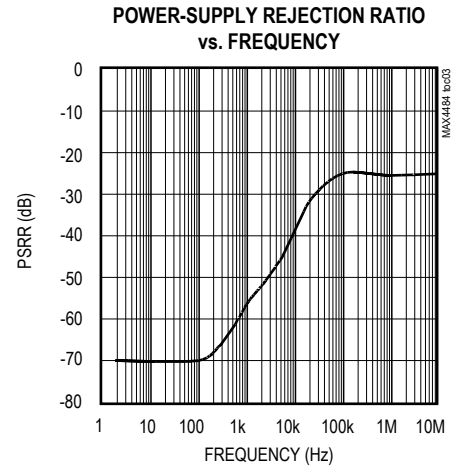
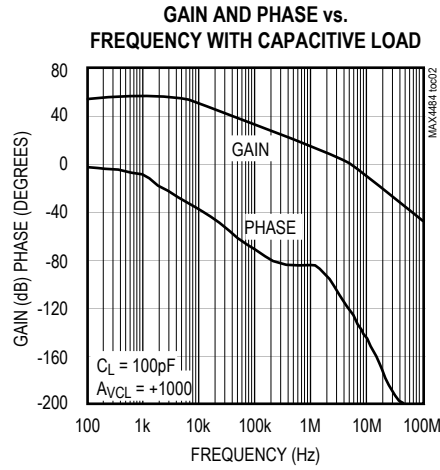
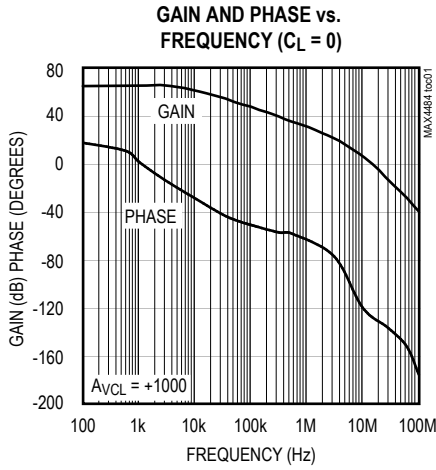

Typical Operating Characteristics (continued)

($V_{DD} = +5V$, $V_{SS} = 0V$, $V_{CM} = V_{DD}/2$, $R_L = \infty$ to $V_{DD}/2$, unless otherwise noted.)

NONINVERTING LARGE-SIGNAL
TRANSIENT RESPONSE

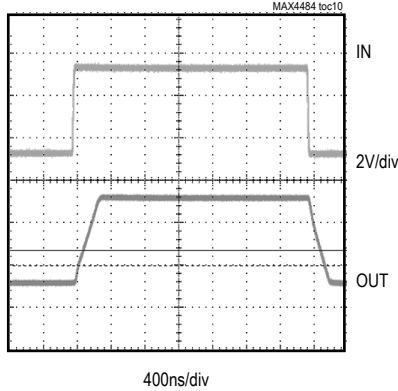

PERCENT OVERSHOOT
vs. CAPACITIVE LOAD

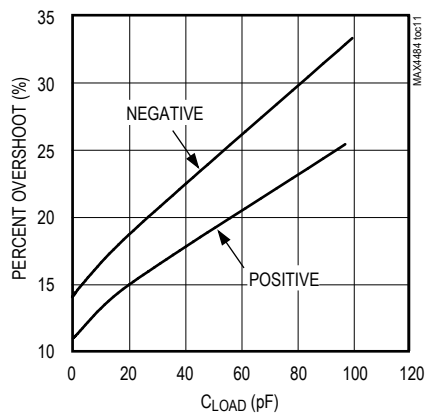

LARGE-SIGNAL GAIN
vs. OUTPUT VOLTAGE LOW

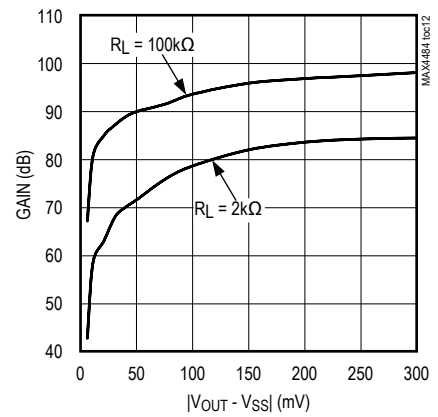

LARGE-SIGNAL GAIN
vs. OUTPUT VOLTAGE HIGH

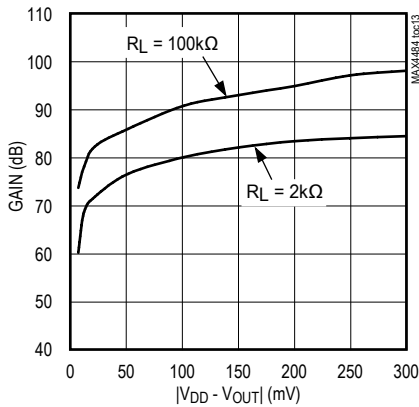

CROSSTALK vs. FREQUENCY

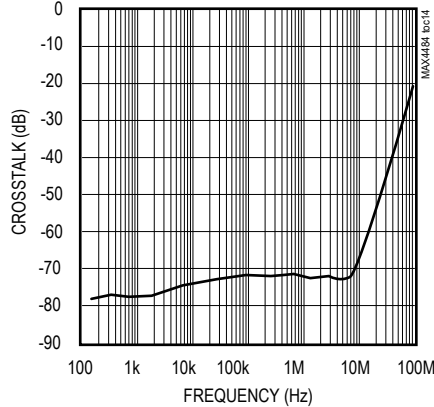

POWER-SUPPLY REJECTION RATIO
vs. OPERATING VOLTAGE

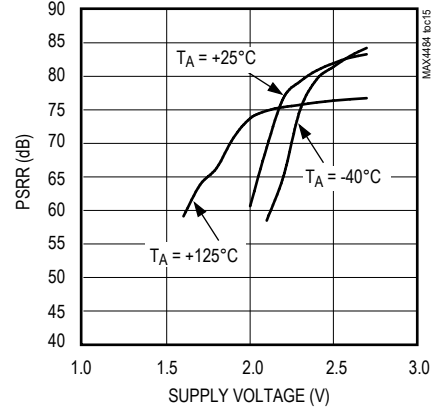

TOTAL HARMONIC DISTORTION
PLUS NOISE vs. FREQUENCY

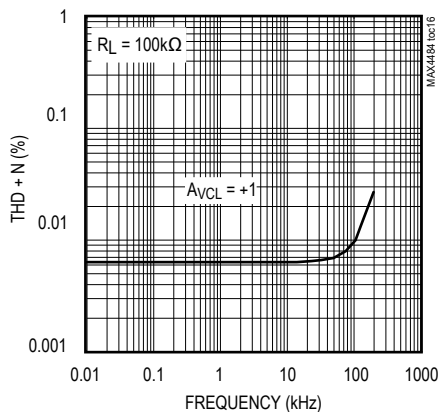

TOTAL HARMONIC DISTORTION
PLUS NOISE vs. AMPLITUDE

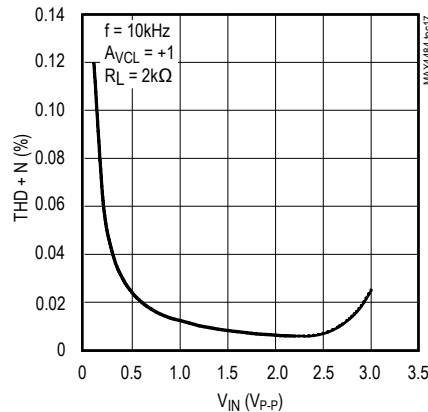

TOTAL HARMONIC DISTORTION
PLUS NOISE vs. AMPLITUDE

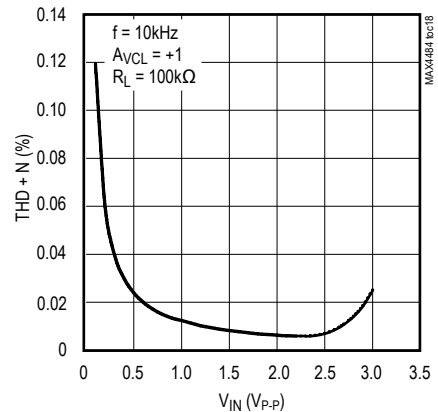

Pin Description

PIN			NAME	FUNCTION
MAX4484	MAX4486	MAX4487		
3	—	—	IN-	Inverting Amplifier Input
1	—	—	IN+	Noninverting Amplifier Input
4	—	—	OUT	Amplifier Output
—	2	2	INA-	Inverting Amplifier Input (Channel A)
—	3	3	INA+	Noninverting Amplifier Input (Channel A)
—	1	1	OUTA	Amplifier Output (Channel A)
—	6	6	INB-	Inverting Amplifier Input (Channel B)
—	5	5	INB+	Noninverting Amplifier Input (Channel B)
—	7	7	OUTB	Amplifier Output (Channel B)
—	—	9	INC-	Inverting Amplifier Input (Channel C)
—	—	10	INC+	Noninverting Amplifier Input (Channel C)
—	—	8	OUTC	Amplifier Output (Channel C)
—	—	13	IND-	Inverting Amplifier Input (Channel D)
—	—	12	IND+	Noninverting Amplifier Input (Channel D)
—	—	14	OUTD	Amplifier Output (Channel D)
2	4	11	V _{SS}	Negative Power-Supply Voltage
5	8	4	V _{DD}	Positive Power-Supply Voltage

Detailed Description

Rail-to-Rail Output Stage

The MAX4484/MAX4486/MAX4487 can drive a 2kΩ load and still swing within 50mV of the supply rails. Figure 1 shows the output swing of the MAX4484 configured with $A_V = +1V/V$.

Driving Capacitive Loads

Driving a capacitive load can cause instability in many op amps, especially those with low quiescent current. The MAX4484/MAX4486/MAX4487 are unity-gain stable for a range of capacitive loads up to 100pF. Figure 2 shows the response of the MAX4484 with an excessive capacitive load. Adding a series resistor between the output and the load capacitor (Figure 3) improves the circuit's response by isolating the load capacitance from the op amp's output.

Applications Information

Power Supplies and Layout

The MAX4484/MAX4486/MAX4487 operate from a single +2.7V to +5.5V power supply. Bypass the power supply with 0.1μF capacitor to ground. Good layout techniques optimize performance by decreasing the amount of stray capacitance at the op amp's inputs and outputs. To decrease stray capacitance, minimize trace lengths by placing external components close to the op amp's pins. Use surface-mount components for best results.

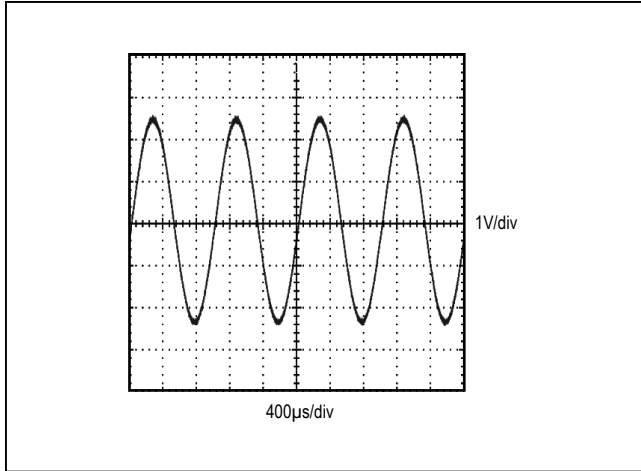

Figure 1. Rail-to-Rail Output Operation

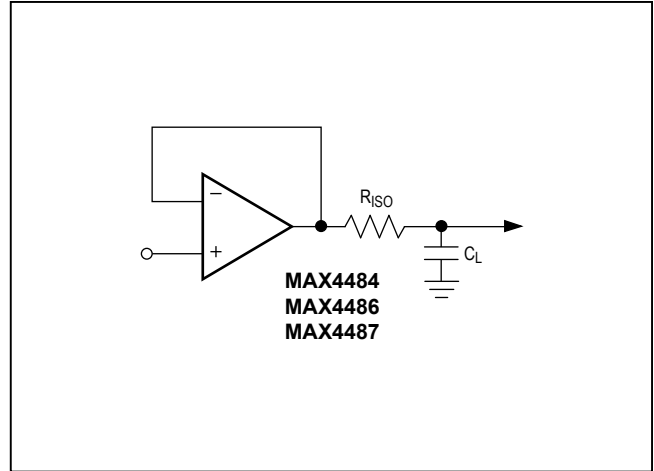

Figure 3. Capacitive-Load-Driving Circuit

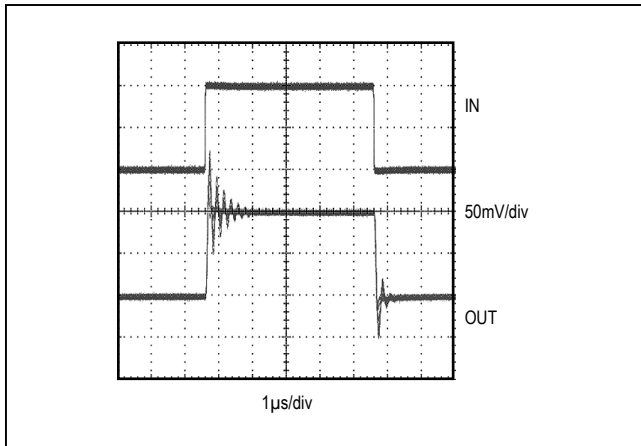

Figure 2. Small-Signal Transient Response with Excessive Capacitive Load ($C_L = 270\text{pF}$)

Package Information

For the latest package outline information and land patterns (footprints), go to www.maximintegrated.com/packages. Note that a "+", "#", or "-" in the package code indicates RoHS status only. Package drawings may show a different suffix character, but the drawing pertains to the package regardless of RoHS status.

PACKAGE TYPE	PACKAGE CODE	DOCUMENT NO.	LAND PATTERN NO.
5 SC70	X5-1	21-0076	90-0188
5 SOT23	U5-1	21-0057	90-0174
8 SOT23	U8-1	21-0036	90-0092
8 SO	S8-2	21-0041	90-0096
8 µMAX	K8-5	21-0078	90-0176
14 TSSOP	U14-1	21-0066	90-0113
14 SO	S14-1	21-0041	90-0112

MAX4484/MAX4486/
MAX4487

Single/Dual/Quad, Low-Cost, Single-Supply
7MHz, Rail-to-Rail Op Amps

Revision History

REVISION NUMBER	REVISION DATE	DESCRIPTION	PAGES CHANGED
0	10/00	Initial release	—
1	5/14	Updated <i>General Description</i>	1

For pricing, delivery, and ordering information, please contact Maxim Direct at 1-888-629-4642, or visit Maxim Integrated's website at www.maximintegrated.com.

Maxim Integrated cannot assume responsibility for use of any circuitry other than circuitry entirely embodied in a Maxim Integrated product. No circuit patent licenses are implied. Maxim Integrated reserves the right to change the circuitry and specifications without notice at any time. The parametric values (min and max limits) shown in the Electrical Characteristics table are guaranteed. Other parametric values quoted in this data sheet are provided for guidance.

Looking for pricing, stock, or lifecycle information?

Click below to explore more details on WIN SOURCE:

- ⊖ [View MAX4484AUK+T on WIN SOURCE](#)
- ⊖ [Maxim Integrated Information](#)

Optimize Your Supply Chain with WIN SOURCE Solutions

- ✓ Global Sourcing Solution
- ✓ Obsolete Management
- ✓ Cost Control Management
- ✓ Shortage Management
- ✓ Alternative Solution
- ✓ Excess Inventory Management