



**THE DATASHEET OF
MAX4469EKA-T**





Low-Cost, Micropower, SC70/SOT23-8, Microphone Preamplifiers with Complete Shutdown

General Description

The MAX4465–MAX4469 are micropower op amps optimized for use as microphone preamplifiers. They provide the ideal combination of an optimized gain bandwidth product vs. supply current, and low voltage operation in ultra-small packages. The MAX4465/MAX4467/MAX4469 are unity-gain stable and deliver a 200kHz gain bandwidth from only 24 μ A of supply current. The MAX4466/MAX4468 are decompensated for a minimum stable gain of +5V/V and provide a 600kHz gain bandwidth product. In addition, these amplifiers feature Rail-to-Rail® outputs, high A_{VOL} , plus excellent power-supply rejection and common-mode rejection ratios for operation in noisy environments.

The MAX4467/MAX4468 include a complete shutdown mode. In shutdown, the amplifiers' supply current is reduced to 5nA and the bias current to the external microphone is cut off for ultimate power savings. The single MAX4465/MAX4466 are offered in the ultra-small 5-pin SC70 package, while the single with shutdown MAX4467/MAX4468 and dual MAX4469 are available in the space-saving 8-pin SOT23 package.

Applications

Microphone Preamplifiers
Hearing Aids
Cellular Phones
Voice-Recognition Systems
Digital Dictation Devices
Headsets
Portable Computing

Pin Configurations

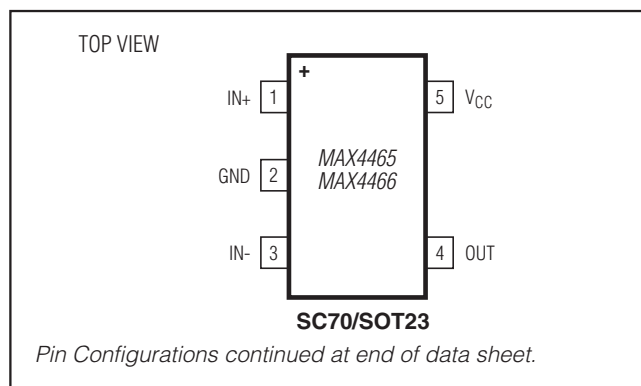

Rail-to-Rail is a registered trademark of Nippon Motorola, Ltd.

Features

- ◆ +2.4V to +5.5V Supply Voltage Operation
- ◆ Versions with 5nA Complete Shutdown Available (MAX4467/MAX4468)
- ◆ Excellent Power-Supply Rejection Ratio: 112dB
- ◆ Excellent Common-Mode Rejection Ratio: 126dB
- ◆ High A_{VOL} : 125dB ($R_L = 100k\Omega$)
- ◆ Rail-to-Rail Outputs
- ◆ Low 24 μ A Quiescent Supply Current
- ◆ Gain Bandwidth Product:
 - 200kHz (MAX4465/MAX4467/MAX4469)
 - 600kHz $A_V \geq 5$ (MAX4466/MAX4468)
- ◆ Available in Space-Saving Packages
 - 5-Pin SC70 (MAX4465/MAX4466)
 - 8-Pin SOT23 (MAX4467/MAX4468/MAX4469)

Ordering Information

PART	TEMP RANGE	PIN-PACKAGE
MAX4465EXK+T	-40°C to +85°C	5 SC70
MAX4465EUK+T	-40°C to +85°C	5 SOT23
MAX4466EXK+T	-40°C to +85°C	5 SC70
MAX4466EUK+T	-40°C to +85°C	5 SOT23

+ Denotes a lead(Pb)-free/RoHS-compliant package.

Ordering Information continued at end of data sheet.

Typical Operating Circuit

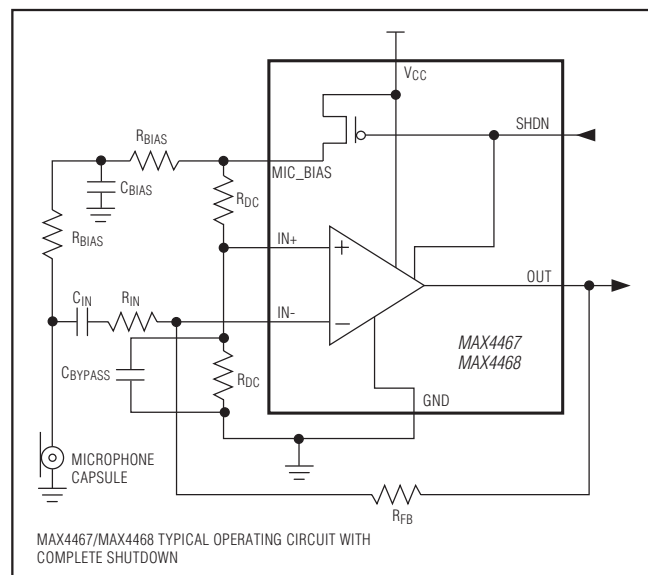

MAX4465–MAX4469

Low-Cost, Micropower, SC70/SOT23-8, Microphone Preamplifiers with Complete Shutdown

ABSOLUTE MAXIMUM RATINGS

Supply Voltage (V _{CC} to GND).....	+6V	8-Pin SOT23 (derate 5.3mW/°C above +70°C)	421mW
All Other Pins to GND.....	-0.3V to (V _{CC} + 0.3V)	Operating Temperature Range	-40°C to +85°C
Output Short-Circuit Duration		Storage Temperature Range	-65°C to +150°C
OUT Shorted to GND or V _{CC}	Continuous	Junction Temperature	+150°C
Continuous Power Dissipation (T _A = +70°C)		Lead Temperature (soldering, 10s)	+300°C
5-Pin SC70 (derate 2.5mW/°C above +70°C)	200mW	Soldering Temperature (reflow)	+260°C
5-Pin SOT23 (derate 7.1mW/°C above +70°C)	571mW		

Stresses beyond those listed under "Absolute Maximum Ratings" may cause permanent damage to the device. These are stress ratings only, and functional operation of the device at these or any other conditions beyond those indicated in the operational sections of the specifications is not implied. Exposure to absolute maximum rating conditions for extended periods may affect device reliability.

ELECTRICAL CHARACTERISTICS

(V_{CC} = +5V, V_{CM} = 0V, V_{OUT} = V_{CC}/2, R_L = ∞ to V_{CC}/2, SHDN = GND (MAX4467/MAX4468 only). T_A = T_{MIN} to T_{MAX}, unless otherwise noted. Typical values specified at T_A = +25°C.) (Note 1)

PARAMETER	SYMBOL	CONDITIONS	MIN	TYP	MAX	UNITS
Supply Voltage Range	V _{CC}	Inferred from PSRR test	2.4		5.5	V
Supply Current (Per Amplifier)	I _{CC}	T _A = +25°C		24	48	μA
		T _A = T _{MIN} to T _{MAX}			60	
Supply Current in Shutdown	I _{SHDN}	SHDN = V _{CC} (Note 2)		5	50	nA
Input Offset Voltage	V _{OS}			±1	±5	mV
Input Bias Current	I _B	V _{CM} = -0.1V		±2.5	±100	nA
Input Offset Current Range	I _{OS}	V _{CM} = -0.1V		±1	±15	nA
Input Common-Mode Range	V _{CM}	Inferred from CMRR test	-0.1		V _{CC} - 0.1	V
Common-Mode Rejection Ratio	CMRR	-0.1V ≤ V _{CM} ≤ V _{CC} - 1V	80	126		dB
Power-Supply Rejection Ratio	PSRR	2.4V ≤ V _{CC} ≤ 5.5V	80	112		dB
		MAX4465/MAX4467/MAX4469, f = 3.4kHz		75		
		MAX4466/MAX4468, f = 3.4kHz		80		
Open-Loop Gain	A _{VOL}	R _L = 100kΩ to V _{CC} /2, 0.05V ≤ V _{OUT} ≤ V _{CC} - 0.05V		125		dB
		R _L = 10kΩ to V _{CC} /2, 0.1V ≤ V _{OUT} ≤ V _{CC} - 0.1V	80	95		
Output Voltage Swing High	V _{OH}	V _{CC} - V _{OH}	R _L = 100kΩ	10		mV
			R _L = 10kΩ	16	50	
Output Voltage Swing Low	V _{OL}		R _L = 100kΩ	10		mV
			R _L = 10kΩ	14	50	
Output Short-Circuit Current		To either supply rail		15		mA
Output Leakage Current in Shutdown		SHDN = V _{CC} , 0 ≤ V _{OUT} ≤ V _{CC} ; (Notes 2, 3)		±0.5	±100	nA
SHDN Logic Low	V _{IL}	(Note 2)			V _{CC} × 0.3	V
SHDN Logic High	V _{IH}	(Note 2)			V _{CC} × 0.7	V
SHDN Input Current		(Note 2)		2	25	nA
Gain Bandwidth Product	GBWP	MAX4465/MAX4467/MAX4469		200		kHz
		MAX4466/MAX4468		600		

Low-Cost, Micropower, SC70/SOT23-8, Microphone Preamplifiers with Complete Shutdown

ELECTRICAL CHARACTERISTICS (continued)

($V_{CC} = +5V$, $V_{CM} = 0V$, $V_{OUT} = V_{CC}/2$, $R_L = \infty$ to $V_{CC}/2$, SHDN = GND (MAX4467/MAX4468 only), $T_A = T_{MIN}$ to T_{MAX} , unless otherwise noted. Typical values specified at $T_A = +25^\circ C$.) (Note 1)

PARAMETER	SYMBOL	CONDITIONS		MIN	TYP	MAX	UNITS
Channel-to-Channel Isolation		MAX4469 only, $f = 1kHz$			85		dB
Phase Margin	ϕ_M	$R_L = 100k\Omega$			70		degrees
Gain Margin		$R_L = 100k\Omega$			20		dB
Slew Rate	SR	Output step = 4V	MAX4465/MAX4467/ MAX4469, $A_V = +1$		45		mV/ μs
			MAX4466/MAX4468, $A_V = +5$		300		
Input Noise Voltage Density	e_n	$f = 1kHz$			80		nV/ \sqrt{Hz}
Total Harmonic Distortion	THD	$f = 1kHz$, $R_L = 10k\Omega$, $V_{OUT} = 2V_{p-p}$	MAX4465/MAX4467/ MAX4469		0.02		%
			MAX4466/MAX4468		0.03		
Capacitive Load Stability	C_{LOAD}	MAX4465/MAX4467/MAX4469, $A_V = +1$			100		pF
		MAX4466/MAX4468, $A_V = +5$			100		
SHDN Delay Time	t_{SHDN}	(Note 2)			1		μs
Enable Delay Time	t_{EN}	(Note 2)			50		μs
Power-On Time	t_{ON}	(Note 2)			40		μs
Bias Switch On-Resistance	R_S	$I_S = 5mA$ (Note 2)			20	500	Ω

Note 1: All specifications are 100% production tested at $T_A = +25^\circ C$. All temperature limits are guaranteed by design.

Note 2: Shutdown mode is available only on the MAX4467/MAX4468.

Note 3: External feedback networks not considered.

Typical Operating Characteristics

($V_{CC} = +5V$, $V_{CM} = 0V$, $V_{OUT} = V_{CC}/2$, $R_L = 100k\Omega$ to $V_{CC}/2$, SHDN = GND (MAX4467/MAX4468 only), $T_A = +25^\circ C$, unless otherwise noted.)

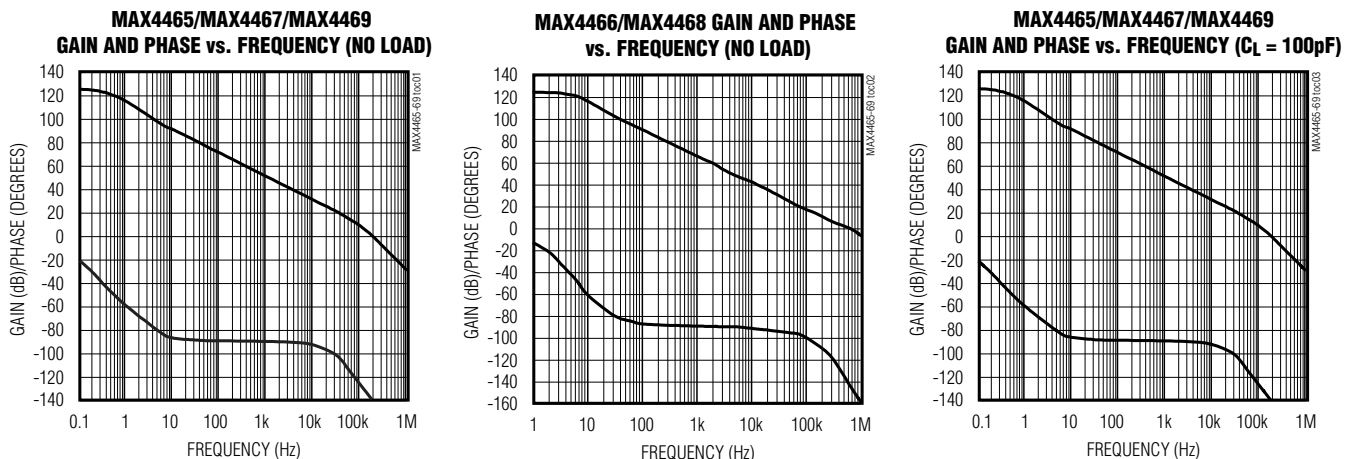

Low-Cost, Micropower, SC70/SOT23-8, Microphone Preamplifiers with Complete Shutdown

Typical Operating Characteristics (continued)

($V_{CC} = +5V$, $V_{CM} = 0V$, $V_{OUT} = V_{CC}/2$, $R_L = 100k\Omega$ to $V_{CC}/2$, SHDN = GND (MAX4467/MAX4468 only), $T_A = +25^\circ C$, unless otherwise noted.)

POWER-SUPPLY REJECTION RATIO vs. FREQUENCY

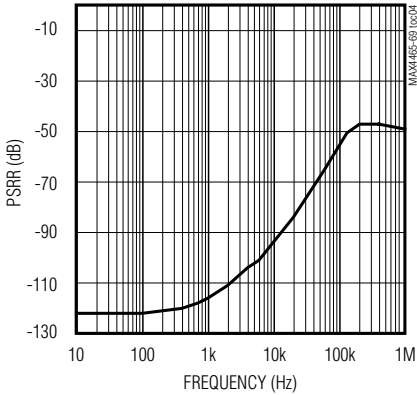

SHUTDOWN SUPPLY CURRENT vs. TEMPERATURE

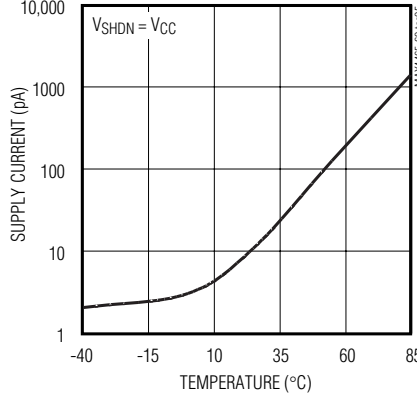

SUPPLY CURRENT vs. TEMPERATURE

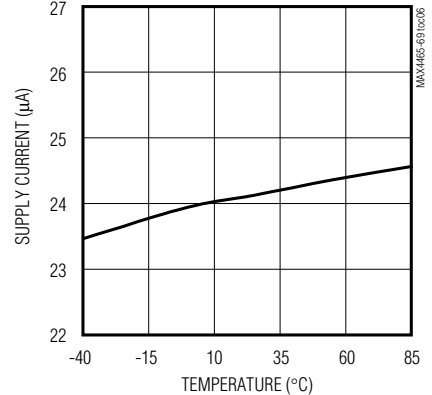

OUTPUT LEAKAGE CURRENT vs. TEMPERATURE

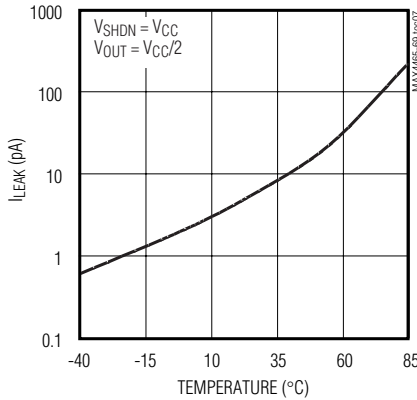

CHANNEL-TO-CHANNEL ISOLATION vs. FREQUENCY

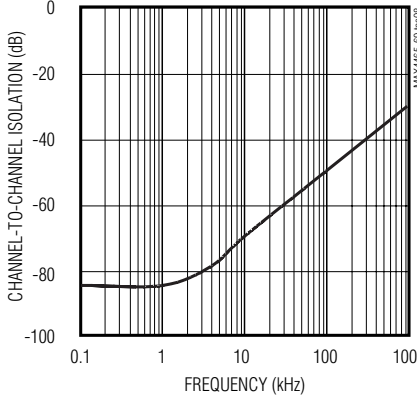

INPUT OFFSET VOLTAGE vs. TEMPERATURE

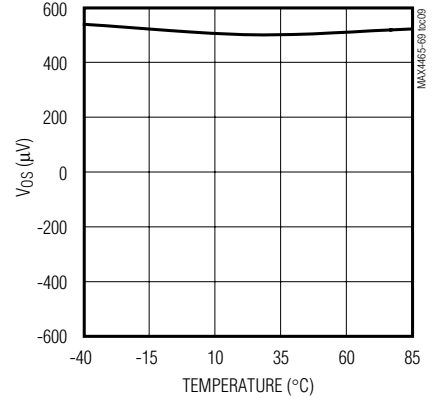

OUTPUT VOLTAGE SWING HIGH vs. TEMPERATURE

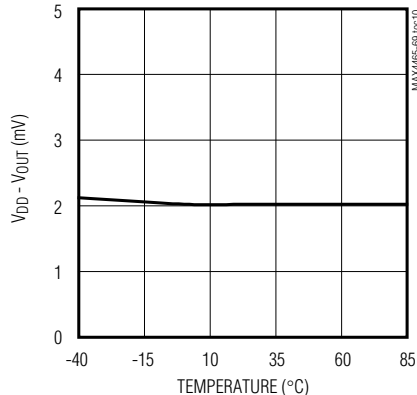

OUTPUT VOLTAGE SWING LOW vs. TEMPERATURE

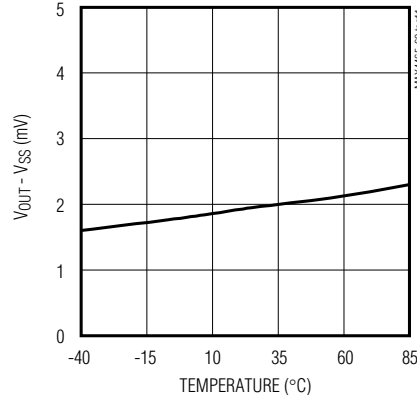

COMMON-MODE REJECTION RATIO vs. TEMPERATURE

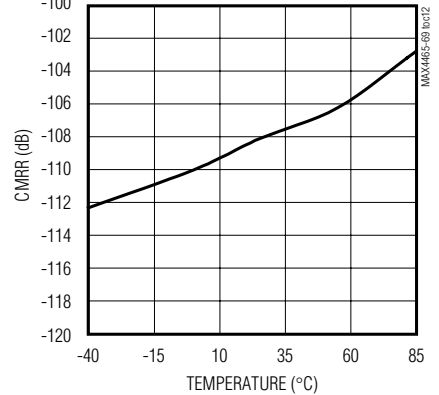

Low-Cost, Micropower, SC70/SOT23-8, Microphone Preamplifiers with Complete Shutdown

MAX4465-MAX4469

Typical Operating Characteristics (continued)

($V_{CC} = +5V$, $V_{CM} = 0V$, $V_{OUT} = V_{CC}/2$, $R_L = 100k\Omega$ to $V_{CC}/2$, SHDN = GND (MAX4467/MAX4468 only), $T_A = +25^\circ C$, unless otherwise noted.)

LARGE-SIGNAL GAIN vs. OUTPUT VOLTAGE

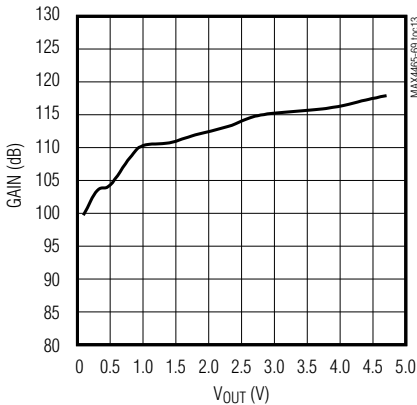

LARGE-SIGNAL GAIN vs. TEMPERATURE

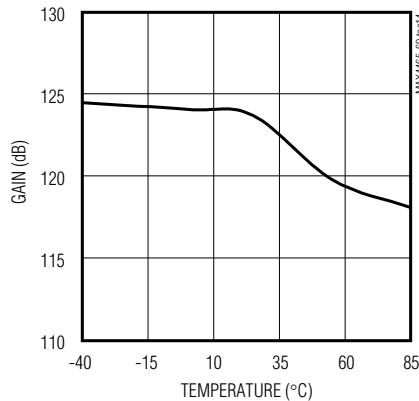

MINIMUM OPERATING VOLTAGE vs. TEMPERATURE

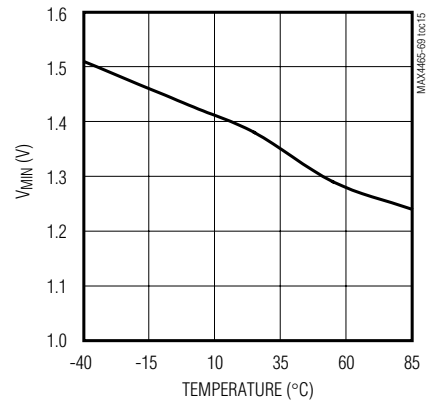

**MAX4465/MAX4467/MAX4469
TOTAL HARMONIC DISTORTION PLUS NOISE vs. FREQUENCY**

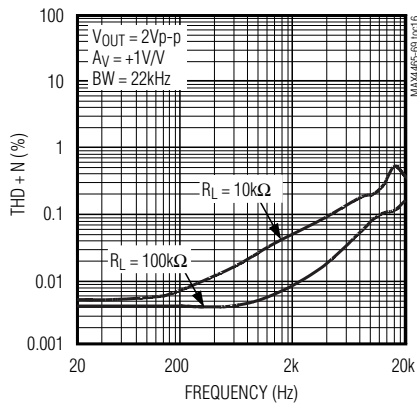

**MAX4466/MAX4468
TOTAL HARMONIC DISTORTION vs. FREQUENCY**

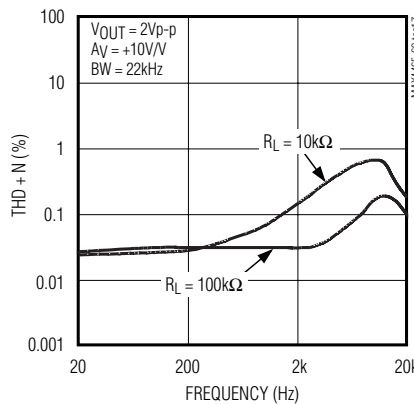

**MAX4465/MAX4467/MAX4469
TOTAL HARMONIC DISTORTION PLUS NOISE vs. INPUT AMPLITUDE**

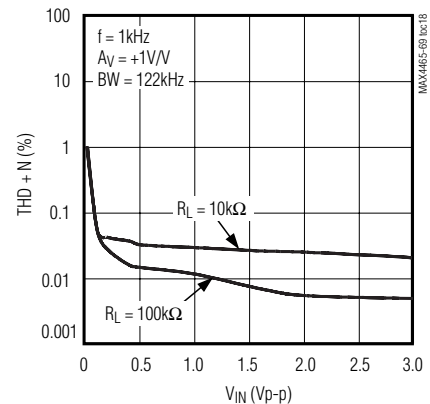

**MAX4466/MAX4468
TOTAL HARMONIC DISTORTION PLUS NOISE vs. INPUT AMPLITUDE**

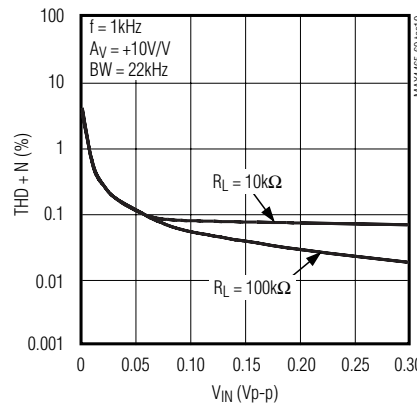

**NONINVERTING SMALL-SIGNAL
TRANSIENT RESPONSE**

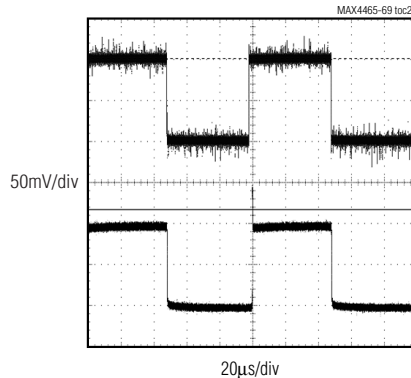

**NONINVERTING LARGE-SIGNAL
TRANSIENT RESPONSE**

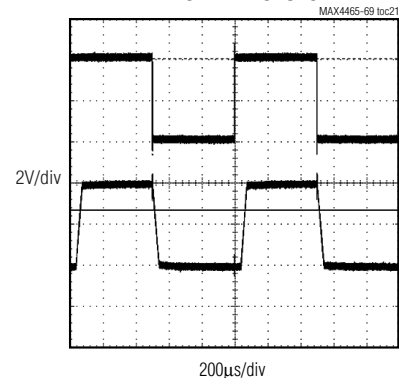

Low-Cost, Micropower, SC70/SOT23-8, Microphone Preamplifiers with Complete Shutdown

Typical Operating Characteristics (continued)

($V_{CC} = +5V$, $V_{CM} = 0V$, $V_{OUT} = V_{CC}/2$, $R_L = 100k\Omega$ to $V_{CC}/2$, SHDN = GND (MAX4467/MAX4468 only), $T_A = +25^\circ C$, unless otherwise noted.)

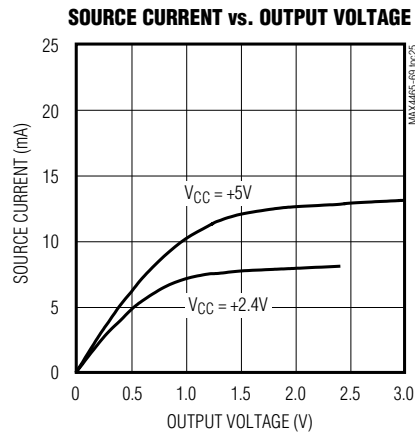
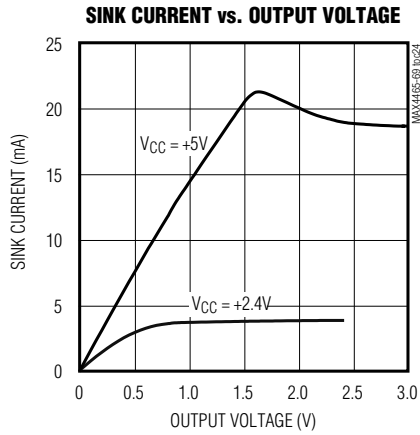
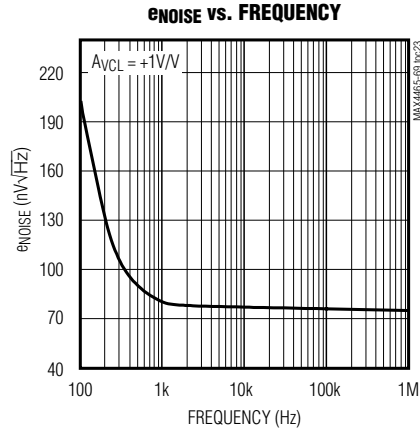
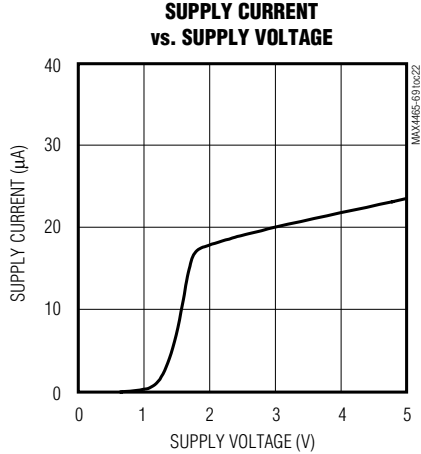

Pin Description

PIN			NAME	FUNCTION
MAX4465 MAX4466	MAX4467 MAX4468	MAX4469		
4	6 (8)	—	OUT	Amplifier Output
—	—	1	OUTA	Amplifier Output A
—	1 (4)	—	MIC_BIAS	External Microphone Bias Network Switch Output
3	2 (3)	—	IN-	Inverting Amplifier Input
1	3 (2)	—	IN+	Noninverting Amplifier Input
2	4 (1)	4	GND	Ground

() denotes SOT23 package of the MAX4467/MAX4468

Low-Cost, Micropower, SC70/SOT23-8, Microphone Preamplifiers with Complete Shutdown

MAX4465-MAX4469

Pin Description (continued)

PIN			NAME	FUNCTION
MAX4465 MAX4466	MAX4467 MAX4468	MAX4469		
5	7 (7)	8	V _{CC}	Positive Supply. Bypass with a 0.1μF capacitor to GND.
—	—	2	INA-	Inverting Amplifier Input A
—	—	3	INA+	Noninverting Amplifier Input A
—	—	6	INB-	Inverting Amplifier Input B
—	—	5	INB+	Noninverting Amplifier Input B
—	—	7	OUTB	Amplifier Output B
—	8 (6)	—	SHDN	Active-High Shutdown Input. Connect to GND for normal operation. Connect to V _{CC} for shutdown. Do not leave unconnected.
—	5 (5)	—	N.C.	No Connection. Not internally connected.

() denotes SOT23 package of the MAX4467/MAX4468.

Detailed Description

The MAX4465–MAX4469 are low-power, micropower op amps designed to be used as microphone preamplifiers. These preamplifiers are an excellent choice for noisy environments because of their high common-mode rejection and excellent power-supply rejection ratios. They operate from a single +2.4V to +5.5V supply.

The MAX4465/MAX4467/MAX4469 are unity-gain stable and deliver a 200kHz gain bandwidth from only 24μA of supply current. The MAX4466/MAX4468 have a minimum stable gain of +5V/V while providing a 600kHz gain bandwidth product.

The MAX4467/MAX4468 feature a complete shutdown, which is active-high, and a shutdown-controlled output providing bias to the microphone. The MAX4465/MAX4467/MAX4469 feature a slew rate suited to voice channel applications. The MAX4466/MAX4468 can be used for full-range audio, e.g., PC99 inputs.

Rail-to-Rail Output Stage

The MAX4465–MAX4469 can drive a 10kΩ load and still typically swing within 16mV of the supply rails. Figure 1 shows the output voltage swing of the MAX4465 configured with A_v = +10.

Switched Bias Supply

When used as a microphone amplifier for an electret microphone, some form of DC bias for the microphone is necessary. The MAX4467/MAX4468 have the ability to

turn off the bias to the microphone when the device is in shutdown. This can save several hundred microamps of supply current, which can be significant in low power applications. The MIC_BIAS pin provides a switched version of V_{CC} to the bias components. Figure 3 shows some typical values.

Driving Capacitive Loads

Driving a capacitive load can cause instability in many op amps, especially those with low quiescent current. The MAX4465/MAX4467/MAX4469 are unity-gain stable for a range of capacitive loads up to 100pF. Figure 4 shows the response of the MAX4465 with an excessive capacitive load.

Applications Information

Shutdown Mode

The MAX4467 and MAX4468 feature a low-power, complete shutdown mode. When SHDN goes high, the supply current drops to 5nA, the output enters a high impedance state and the bias current to the microphone is switched off. Pull SHDN low to enable the amplifier. Do not leave SHDN unconnected. Figure 5 shows the shutdown waveform.

Common-Mode Rejection Ratio

A microphone preamplifier ideally only amplifies the signal present on its input and converts it to a voltage appearing at the output. When used in noninverting mode, there is a small output voltage fluctuation when both inputs experience the same voltage change in the

Low-Cost, Micropower, SC70/SOT23-8, Microphone Preamplifiers with Complete Shutdown

common mode. The ratio of these voltages is called the common-mode gain. The common-mode rejection ratio is the ratio of differential-mode gain to common-mode gain. The high CMRR properties of the MAX4465-MAX4469 provide outstanding performances when configured as a noninverting microphone preamplifier.

Power-Up

The MAX4465-MAX4469 outputs typically settle within 1 μ s after power-up. Figure 6 shows the output voltage on power-up.

Power Supplies and Layout

The MAX4465-MAX4469 operate from a single +2.4V to +5.5V power supply. Bypass the power supply with a 0.1 μ F capacitor to ground. Good layout techniques are necessary for the MAX4465-MAX4469 family. To decrease stray capacitance, minimize trace lengths by placing external components close to the op amp's pins. Surface-mount components are recommended. In systems where analog and digital grounds are available, the MAX4465-MAX4469 should be connected to the analog ground.

Test Circuits/Timing Diagrams

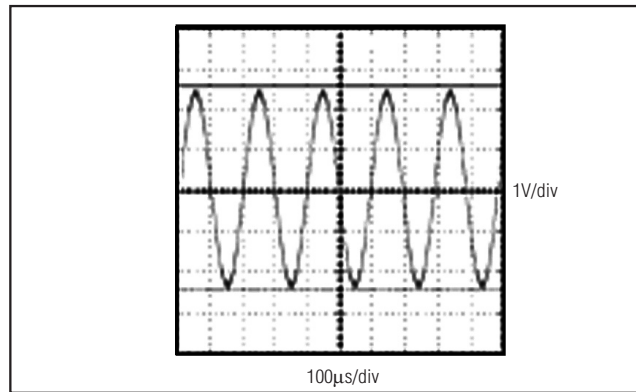

Figure 1. Rail-to-Rail Output Operation

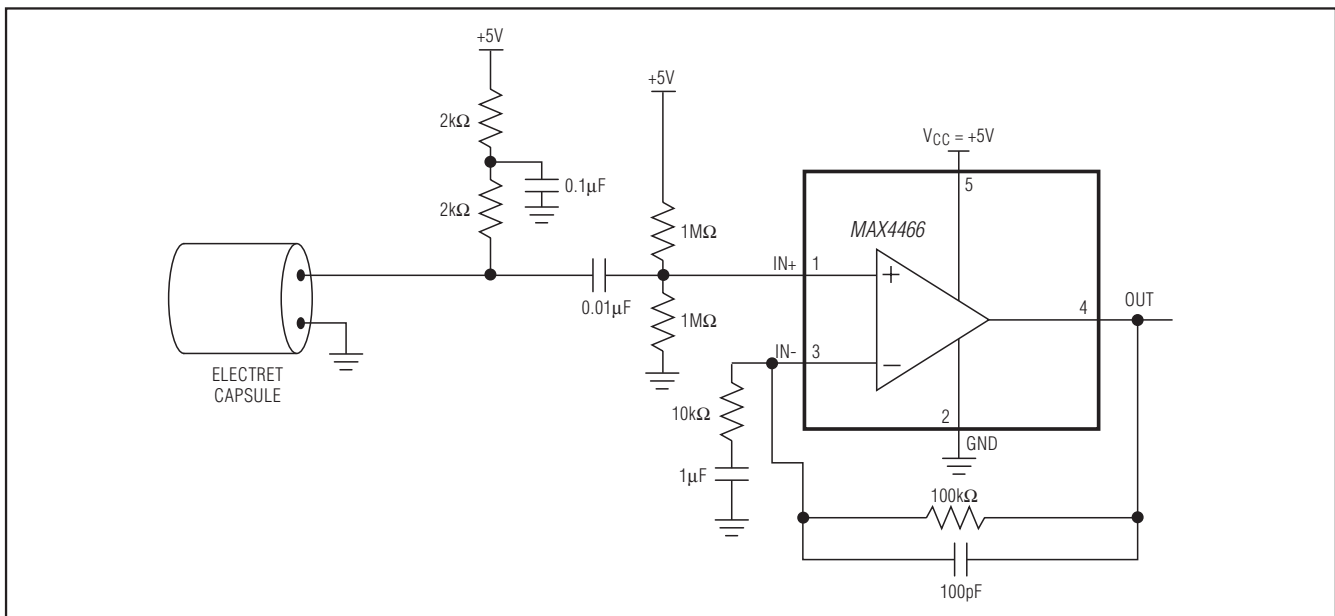

Figure 2. MAX4466 Typical Application Circuit

Low-Cost, Micropower, SC70/SOT23-8, Microphone Preamplifiers with Complete Shutdown

Test Circuits/Timing Diagrams (continued)

MAX4465-MAX4469

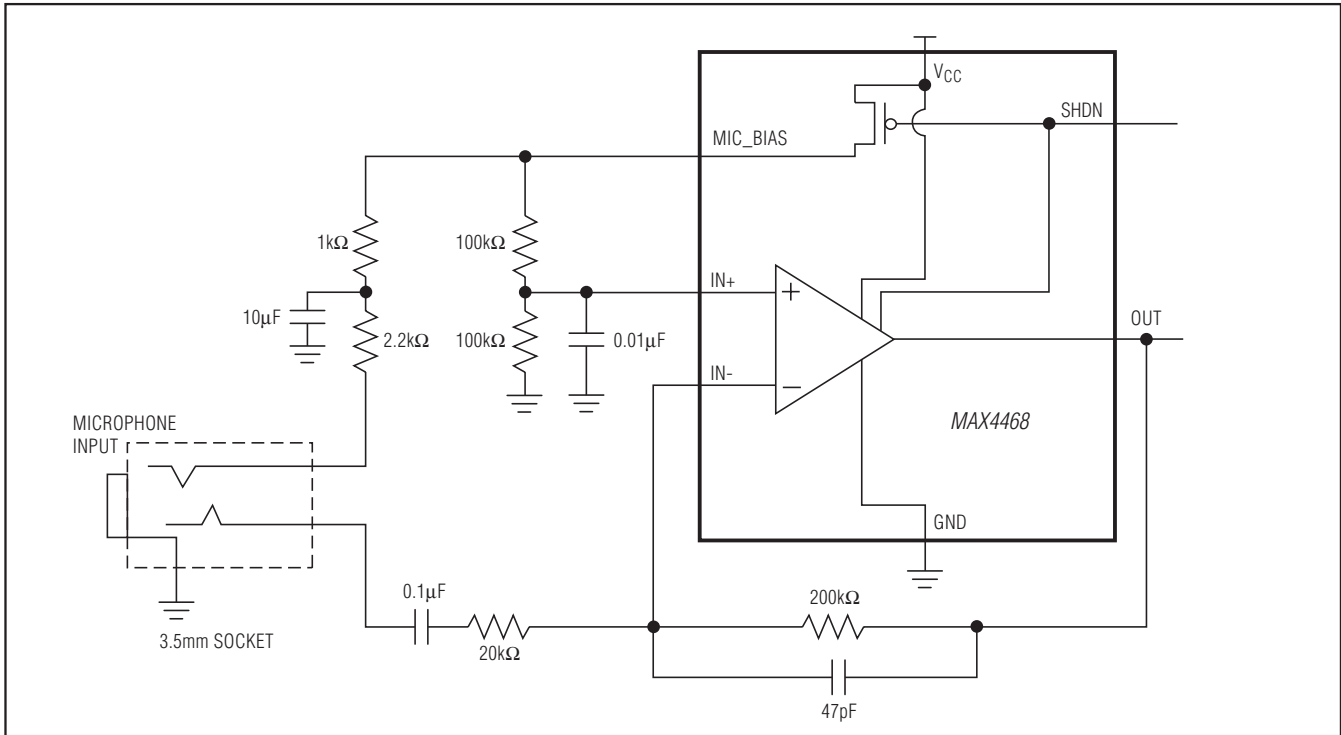

Figure 3. Bias Network Circuit

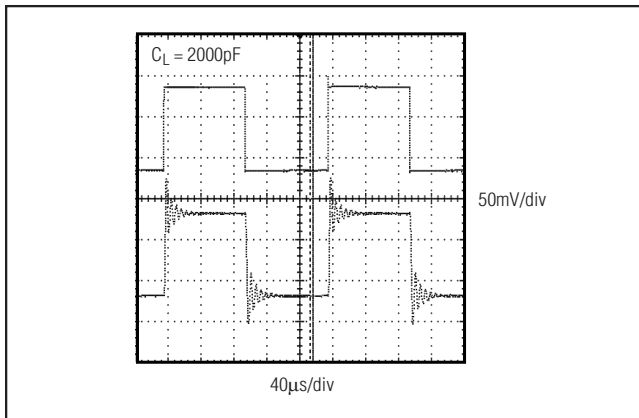

Figure 4. Small-Signal Transient Response with Excessive Capacitive Load

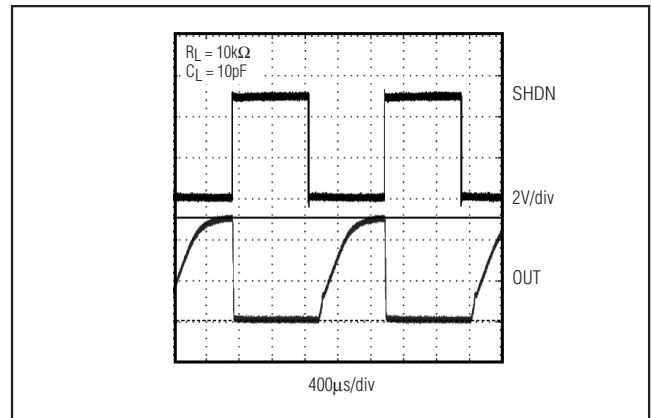

Figure 5. MAX4467/MAX4468 Shutdown Waveform

Low-Cost, Micropower, SC70/SOT23-8, Microphone Preamplifiers with Complete Shutdown

Test Circuits/Timing Diagrams (continued)

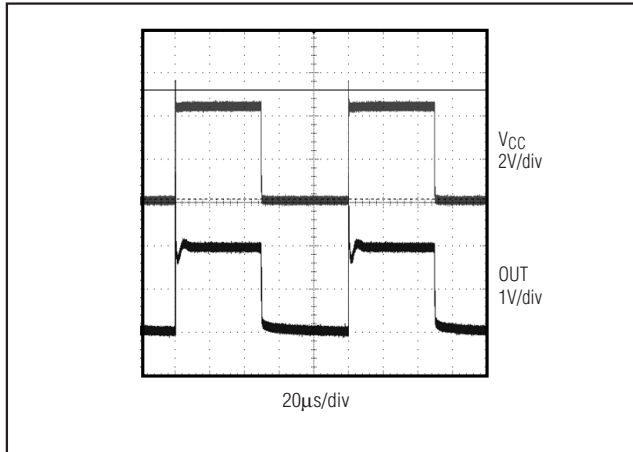

Figure 6. Power-Up/Power-Down Waveform

Chip Information

PROCESS: BICMOS

Ordering Information (continued)

PART	TEMP RANGE	PIN-PACKAGE
MAX4467EKA+T	-40°C to +85°C	8 SOT23
MAX4468EKA+T	-40°C to +85°C	8 SOT23
MAX4469EKA+T	-40°C to +85°C	8 SOT23

+Denotes a lead(Pb)-free/RoHS-compliant package.

Selector Guide

PART	MINIMUM STABLE GAIN	EXTERNAL MICROPHONE SHDN	GBWP (kHz)	PIN-PACKAGE
MAX4465	+1	No	200	5 SC70/5 SOT23
MAX4466	+5	No	600	5 SC70/5 SOT23
MAX4467	+1	Yes	200	8 SOT23
MAX4468	+5	Yes	600	8 SOT23
MAX4469	+1	No	200	8 SOT23

Pin Configurations (continued)

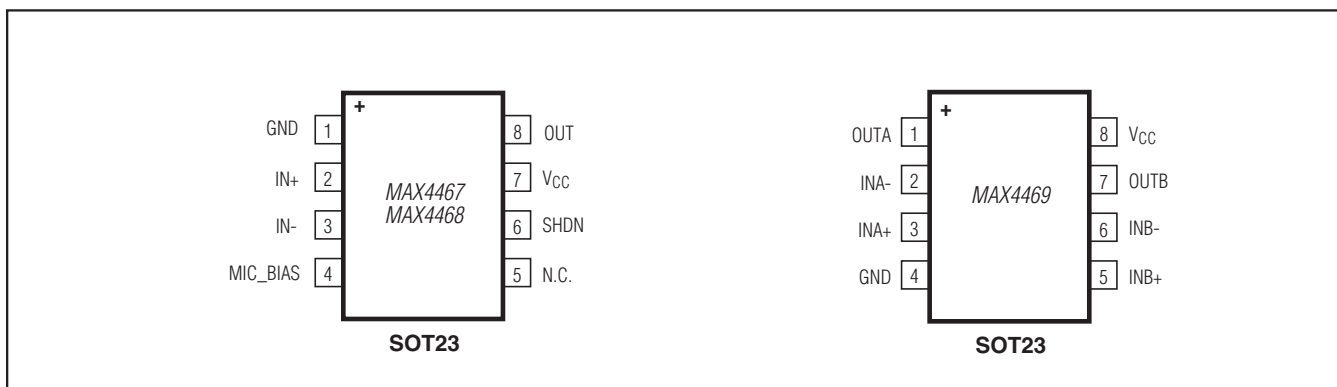

Low-Cost, Micropower, SC70/SOT23-8, Microphone Preamplifiers with Complete Shutdown

Package Information

For the latest package outline information and land patterns (footprints), go to www.maxim-ic.com/packages. Note that a "+", "#", or "-" in the package code indicates RoHS status only. Package drawings may show a different suffix character, but the drawing pertains to the package regardless of RoHS status.

PACKAGE TYPE	PACKAGE CODE	OUTLINE NO.	LAND PATTERN NO.
SOT23-5	U5+1	21-0057	90-0174
SC70	X5+1	21-0076	90-0188
SOT23-8	K8+5	21-0078	90-0176

MAX4465-MAX4469

Low-Cost, Micropower, SC70/SOT23-8, Microphone Preamplifiers with Complete Shutdown



Revision History

REVISION NUMBER	REVISION DATE	DESCRIPTION	PAGES CHANGED
2	6/12	Added lead-free packaging information, removed SO packaging information	1, 2, 10

Maxim cannot assume responsibility for use of any circuitry other than circuitry entirely embodied in a Maxim product. No circuit patent licenses are implied. Maxim reserves the right to change the circuitry and specifications without notice at any time. The parametric values (min and max limits) shown in the Electrical Characteristics table are guaranteed. Other parametric values quoted in this data sheet are provided for guidance.

Looking for pricing, stock, or lifecycle information?

Click below to explore more details on WIN SOURCE:

-  [View MAX4469EKA-T on WIN SOURCE](#)
-  [Maxim Integrated Information](#)

Optimize Your Supply Chain with WIN SOURCE Solutions

-  Global Sourcing Solution
-  Obsolete Management
-  Cost Control Management
-  Shortage Management
-  Alternative Solution
-  Excess Inventory Management