



**THE DATASHEET OF  
MAX4466EXK+T**





# Low-Cost, Micropower, SC70/SOT23-8, Microphone Preamplifiers with Complete Shutdown

## General Description

The MAX4465–MAX4469 are micropower op amps optimized for use as microphone preamplifiers. They provide the ideal combination of an optimized gain bandwidth product vs. supply current, and low voltage operation in ultra-small packages. The MAX4465/MAX4467/MAX4469 are unity-gain stable and deliver a 200kHz gain bandwidth from only 24 $\mu$ A of supply current. The MAX4466/MAX4468 are decompensated for a minimum stable gain of +5V/V and provide a 600kHz gain bandwidth product. In addition, these amplifiers feature Rail-to-Rail® outputs, high  $A_{VOL}$ , plus excellent power-supply rejection and common-mode rejection ratios for operation in noisy environments.

The MAX4467/MAX4468 include a complete shutdown mode. In shutdown, the amplifiers' supply current is reduced to 5nA and the bias current to the external microphone is cut off for ultimate power savings. The single MAX4465/MAX4466 are offered in the ultra-small 5-pin SC70 package, while the single with shutdown MAX4467/MAX4468 and dual MAX4469 are available in the space-saving 8-pin SOT23 package.

## Applications

Microphone Preamplifiers  
Hearing Aids  
Cellular Phones  
Voice-Recognition Systems  
Digital Dictation Devices  
Headsets  
Portable Computing

## Pin Configurations

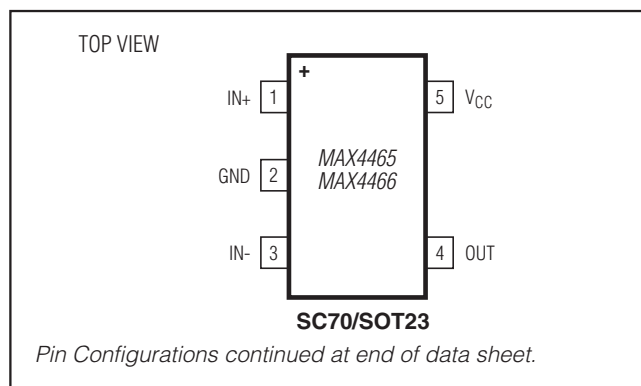

Rail-to-Rail is a registered trademark of Nippon Motorola, Ltd.

## Features

- ◆ +2.4V to +5.5V Supply Voltage Operation
- ◆ Versions with 5nA Complete Shutdown Available (MAX4467/MAX4468)
- ◆ Excellent Power-Supply Rejection Ratio: 112dB
- ◆ Excellent Common-Mode Rejection Ratio: 126dB
- ◆ High  $A_{VOL}$ : 125dB ( $R_L = 100k\Omega$ )
- ◆ Rail-to-Rail Outputs
- ◆ Low 24 $\mu$ A Quiescent Supply Current
- ◆ Gain Bandwidth Product:
  - 200kHz (MAX4465/MAX4467/MAX4469)
  - 600kHz  $A_V \geq 5$  (MAX4466/MAX4468)
- ◆ Available in Space-Saving Packages
  - 5-Pin SC70 (MAX4465/MAX4466)
  - 8-Pin SOT23 (MAX4467/MAX4468/MAX4469)

## Ordering Information

PART	TEMP RANGE	PIN-PACKAGE
MAX4465EXK+T	-40°C to +85°C	5 SC70
MAX4465EUK+T	-40°C to +85°C	5 SOT23
MAX4466EXK+T	-40°C to +85°C	5 SC70
MAX4466EUK+T	-40°C to +85°C	5 SOT23

+ Denotes a lead(Pb)-free/RoHS-compliant package.

Ordering Information continued at end of data sheet.

## Typical Operating Circuit

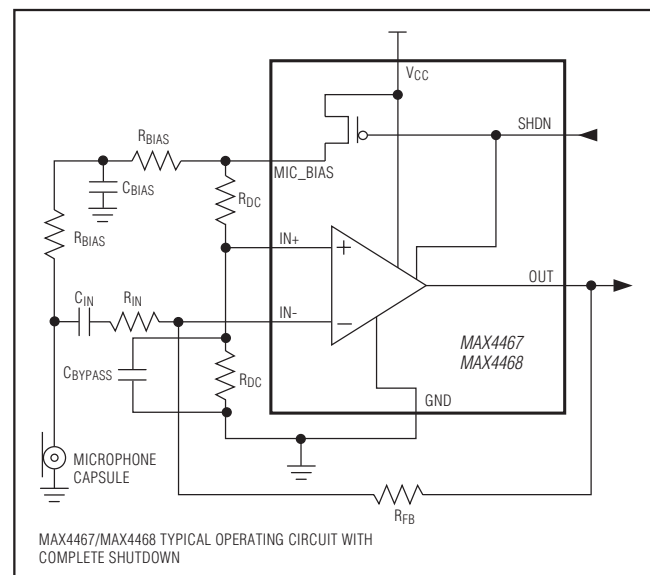

MAX4465–MAX4469

For pricing, delivery, and ordering information, please contact Maxim Direct at 1-888-629-4642, or visit Maxim's website at [www.maxim-ic.com](http://www.maxim-ic.com).

# Low-Cost, Micropower, SC70/SOT23-8, Microphone Preamplifiers with Complete Shutdown

## ABSOLUTE MAXIMUM RATINGS

Supply Voltage ( $V_{CC}$ to GND).....	+6V
All Other Pins to GND.....	-0.3V to ( $V_{CC} + 0.3V$ )
Output Short-Circuit Duration	
OUT Shorted to GND or $V_{CC}$ .....	Continuous
Continuous Power Dissipation ( $T_A = +70^\circ\text{C}$ )	
5-Pin SC70 (derate 2.5mW/ $^\circ\text{C}$ above $+70^\circ\text{C}$ ) .....	200mW
5-Pin SOT23 (derate 7.1mW/ $^\circ\text{C}$ above $+70^\circ\text{C}$ ) .....	571mW

8-Pin SOT23 (derate 5.3mW/ $^\circ\text{C}$ above $+70^\circ\text{C}$ ) .....	421mW
Operating Temperature Range .....	$-40^\circ\text{C}$ to $+85^\circ\text{C}$
Storage Temperature Range .....	$-65^\circ\text{C}$ to $+150^\circ\text{C}$
Junction Temperature .....	$+150^\circ\text{C}$
Lead Temperature (soldering, 10s) .....	$+300^\circ\text{C}$
Soldering Temperature (reflow) .....	$+260^\circ\text{C}$

Stresses beyond those listed under "Absolute Maximum Ratings" may cause permanent damage to the device. These are stress ratings only, and functional operation of the device at these or any other conditions beyond those indicated in the operational sections of the specifications is not implied. Exposure to absolute maximum rating conditions for extended periods may affect device reliability.

## ELECTRICAL CHARACTERISTICS

( $V_{CC} = +5V$ ,  $V_{CM} = 0V$ ,  $V_{OUT} = V_{CC}/2$ ,  $R_L = \infty$  to  $V_{CC}/2$ , SHDN = GND (MAX4467/MAX4468 only).  $T_A = T_{MIN}$  to  $T_{MAX}$ , unless otherwise noted. Typical values specified at  $T_A = +25^\circ\text{C}$ .) (Note 1)

PARAMETER	SYMBOL	CONDITIONS	MIN	TYP	MAX	UNITS
Supply Voltage Range	$V_{CC}$	Inferred from PSRR test	2.4		5.5	V
Supply Current (Per Amplifier)	$I_{CC}$	$T_A = +25^\circ\text{C}$ $T_A = T_{MIN}$ to $T_{MAX}$		24	48	$\mu\text{A}$
Supply Current in Shutdown	$I_{SHDN}$	SHDN = $V_{CC}$ (Note 2)		5	50	nA
Input Offset Voltage	$V_{OS}$			$\pm 1$	$\pm 5$	mV
Input Bias Current	$I_B$	$V_{CM} = -0.1V$		$\pm 2.5$	$\pm 100$	nA
Input Offset Current Range	$I_{OS}$	$V_{CM} = -0.1V$		$\pm 1$	$\pm 15$	nA
Input Common-Mode Range	$V_{CM}$	Inferred from CMRR test	-0.1		$V_{CC} - 0.1$	V
Common-Mode Rejection Ratio	CMRR	$-0.1V \leq V_{CM} \leq V_{CC} - 1V$	80	126		dB
Power-Supply Rejection Ratio	PSRR	$2.4V \leq V_{CC} \leq 5.5V$	80	112		dB
		MAX4465/MAX4467/MAX4469, $f = 3.4\text{kHz}$		75		
		MAX4466/MAX4468, $f = 3.4\text{kHz}$		80		
Open-Loop Gain	$A_{VOL}$	$R_L = 100k\Omega$ to $V_{CC}/2$ , $0.05V \leq V_{OUT} \leq V_{CC} - 0.05V$		125		dB
		$R_L = 10k\Omega$ to $V_{CC}/2$ , $0.1V \leq V_{OUT} \leq V_{CC} - 0.1V$	80	95		
Output Voltage Swing High	$V_{OH}$	$ V_{CC} - V_{OH} $	$R_L = 100k\Omega$	10		mV
			$R_L = 10k\Omega$	16	50	
Output Voltage Swing Low	$V_{OL}$		$R_L = 100k\Omega$	10		mV
			$R_L = 10k\Omega$	14	50	
Output Short-Circuit Current		To either supply rail		15		mA
Output Leakage Current in Shutdown		SHDN = $V_{CC}$ , $0 \leq V_{OUT} \leq V_{CC}$ ; (Notes 2, 3)		$\pm 0.5$	$\pm 100$	nA
SHDN Logic Low	$V_{IL}$	(Note 2)			$V_{CC} \times 0.3$	V
SHDN Logic High	$V_{IH}$	(Note 2)			$V_{CC} \times 0.7$	V
SHDN Input Current		(Note 2)		2	25	nA
Gain Bandwidth Product	GBWP	MAX4465/MAX4467/MAX4469		200		kHz
		MAX4466/MAX4468		600		

# Low-Cost, Micropower, SC70/SOT23-8, Microphone Preamplifiers with Complete Shutdown

## ELECTRICAL CHARACTERISTICS (continued)

( $V_{CC} = +5V$ ,  $V_{CM} = 0V$ ,  $V_{OUT} = V_{CC}/2$ ,  $R_L = \infty$  to  $V_{CC}/2$ , SHDN = GND (MAX4467/MAX4468 only),  $T_A = T_{MIN}$  to  $T_{MAX}$ , unless otherwise noted. Typical values specified at  $T_A = +25^\circ C$ .) (Note 1)

PARAMETER	SYMBOL	CONDITIONS		MIN	TYP	MAX	UNITS
Channel-to-Channel Isolation		MAX4469 only, $f = 1kHz$			85		dB
Phase Margin	$\phi_M$	$R_L = 100k\Omega$			70		degrees
Gain Margin		$R_L = 100k\Omega$			20		dB
Slew Rate	SR	Output step = 4V	MAX4465/MAX4467/ MAX4469, $A_V = +1$		45		mV/ $\mu s$
			MAX4466/MAX4468, $A_V = +5$		300		
Input Noise Voltage Density	$e_n$	$f = 1kHz$			80		nV/ $\sqrt{Hz}$
Total Harmonic Distortion	THD	$f = 1kHz$ , $R_L = 10k\Omega$ , $V_{OUT} = 2V_{p-p}$	MAX4465/MAX4467/ MAX4469		0.02		%
			MAX4466/MAX4468		0.03		
Capacitive Load Stability	$C_{LOAD}$	MAX4465/MAX4467/MAX4469, $A_V = +1$			100		pF
		MAX4466/MAX4468, $A_V = +5$			100		
SHDN Delay Time	$t_{SHDN}$	(Note 2)			1		$\mu s$
Enable Delay Time	$t_{EN}$	(Note 2)			50		$\mu s$
Power-On Time	$t_{ON}$	(Note 2)			40		$\mu s$
Bias Switch On-Resistance	$R_S$	$I_S = 5mA$ (Note 2)			20	500	$\Omega$

**Note 1:** All specifications are 100% production tested at  $T_A = +25^\circ C$ . All temperature limits are guaranteed by design.

**Note 2:** Shutdown mode is available only on the MAX4467/MAX4468.

**Note 3:** External feedback networks not considered.

## Typical Operating Characteristics

( $V_{CC} = +5V$ ,  $V_{CM} = 0V$ ,  $V_{OUT} = V_{CC}/2$ ,  $R_L = 100k\Omega$  to  $V_{CC}/2$ , SHDN = GND (MAX4467/MAX4468 only),  $T_A = +25^\circ C$ , unless otherwise noted.)

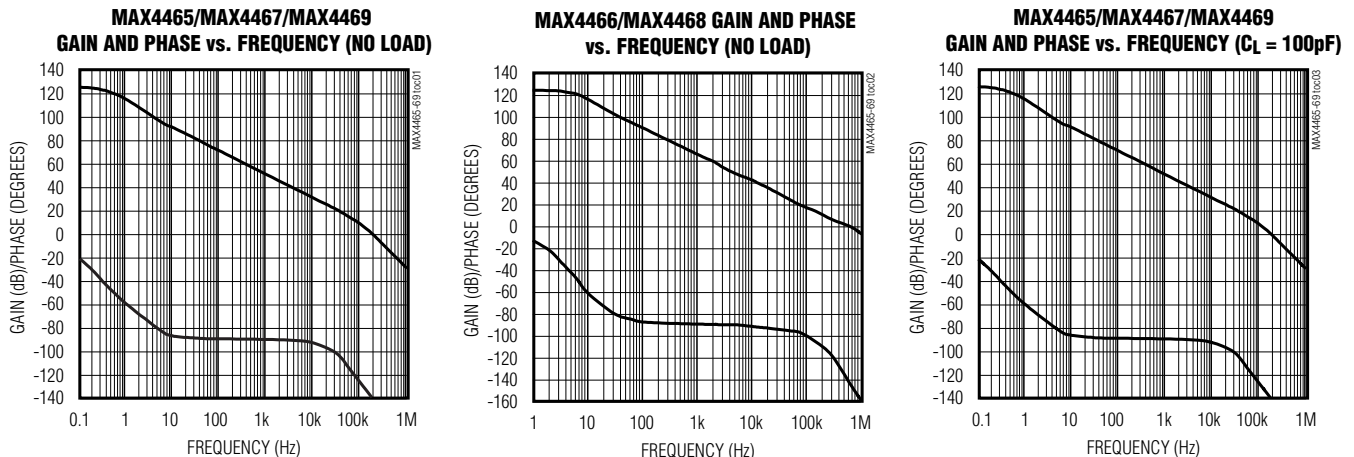

# Low-Cost, Micropower, SC70/SOT23-8, Microphone Preamplifiers with Complete Shutdown

## Typical Operating Characteristics (continued)

( $V_{CC} = +5V$ ,  $V_{CM} = 0V$ ,  $V_{OUT} = V_{CC}/2$ ,  $R_L = 100k\Omega$  to  $V_{CC}/2$ , SHDN = GND (MAX4467/MAX4468 only),  $T_A = +25^\circ C$ , unless otherwise noted.)

**POWER-SUPPLY REJECTION RATIO vs. FREQUENCY**

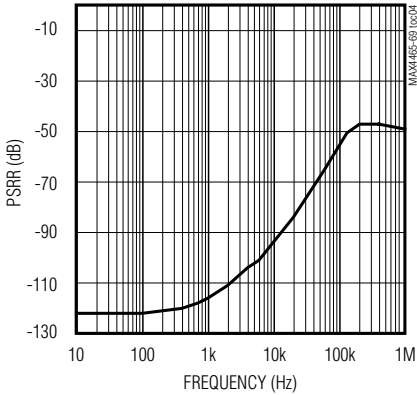

**SHUTDOWN SUPPLY CURRENT vs. TEMPERATURE**

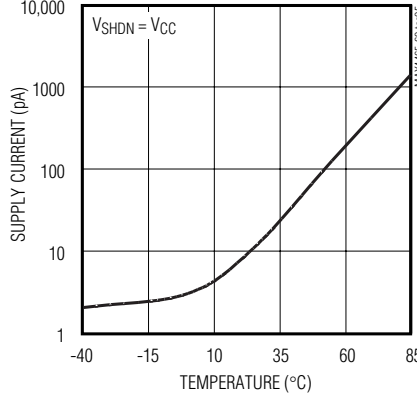

**SUPPLY CURRENT vs. TEMPERATURE**

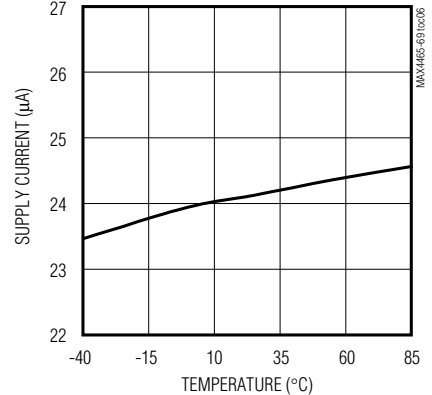

**OUTPUT LEAKAGE CURRENT vs. TEMPERATURE**

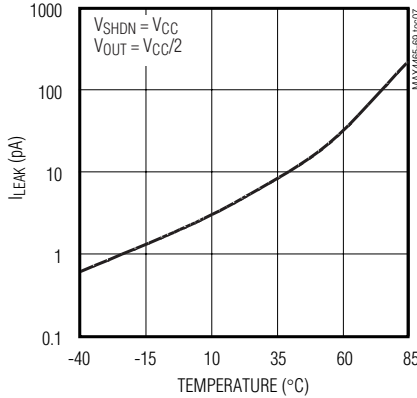

**CHANNEL-TO-CHANNEL ISOLATION vs. FREQUENCY**

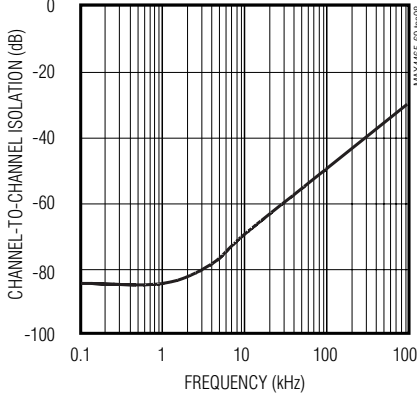

**INPUT OFFSET VOLTAGE vs. TEMPERATURE**

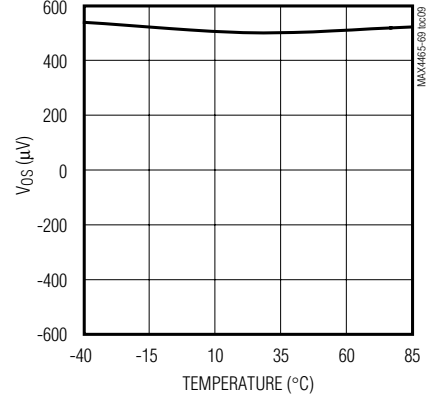

**OUTPUT VOLTAGE SWING HIGH vs. TEMPERATURE**

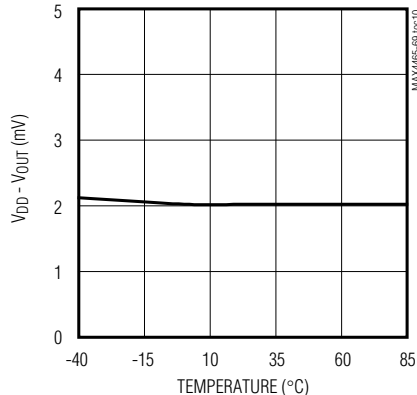

**OUTPUT VOLTAGE SWING LOW vs. TEMPERATURE**

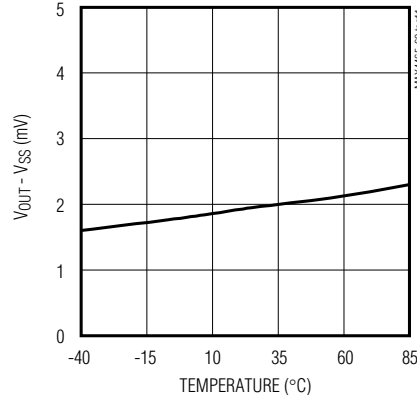

**COMMON-MODE REJECTION RATIO vs. TEMPERATURE**

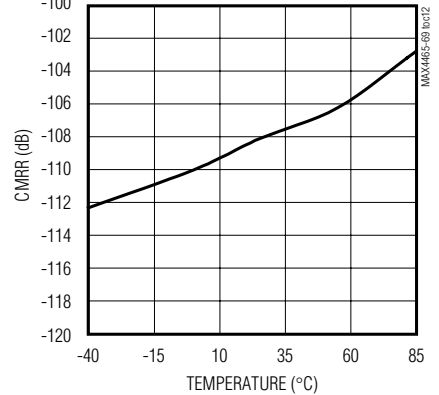

# Low-Cost, Micropower, SC70/SOT23-8, Microphone Preamplifiers with Complete Shutdown

MAX4465-MAX4469

## Typical Operating Characteristics (continued)

( $V_{CC} = +5V$ ,  $V_{CM} = 0V$ ,  $V_{OUT} = V_{CC}/2$ ,  $R_L = 100k\Omega$  to  $V_{CC}/2$ , SHDN = GND (MAX4467/MAX4468 only),  $T_A = +25^\circ C$ , unless otherwise noted.)

**LARGE-SIGNAL GAIN vs. OUTPUT VOLTAGE**

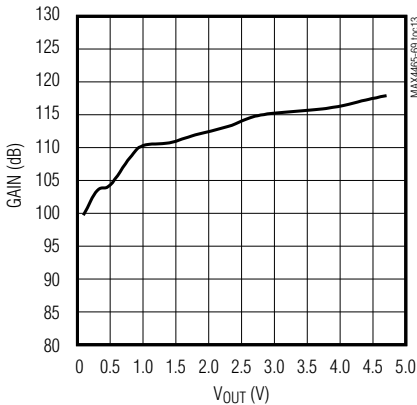

**LARGE-SIGNAL GAIN vs. TEMPERATURE**

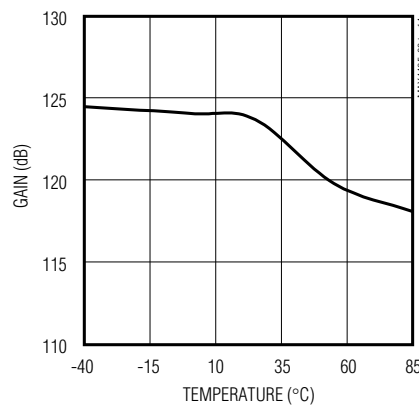

**MINIMUM OPERATING VOLTAGE vs. TEMPERATURE**

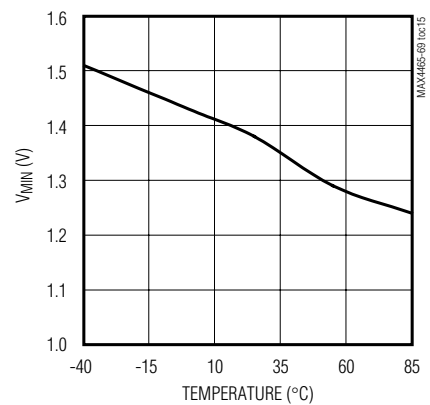

**MAX4465/MAX4467/MAX4469  
TOTAL HARMONIC DISTORTION PLUS NOISE vs. FREQUENCY**

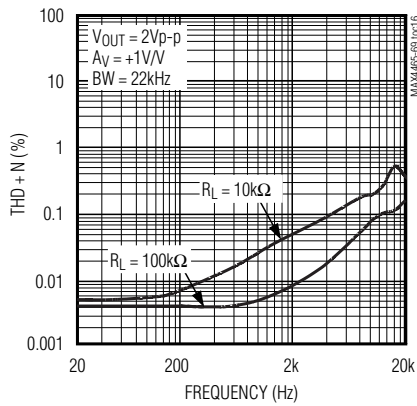

**MAX4466/MAX4468  
TOTAL HARMONIC DISTORTION vs. FREQUENCY**

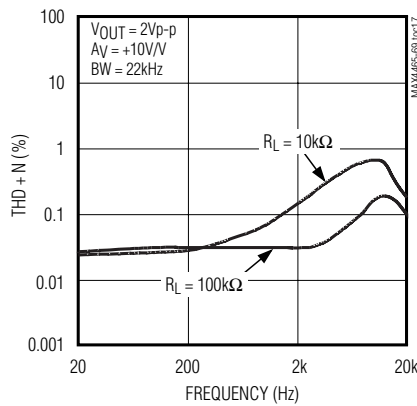

**MAX4465/MAX4467/MAX4469  
TOTAL HARMONIC DISTORTION PLUS NOISE vs. INPUT AMPLITUDE**

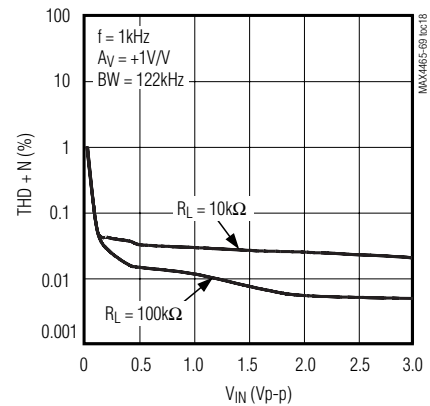

**MAX4466/MAX4468  
TOTAL HARMONIC DISTORTION PLUS NOISE vs. INPUT AMPLITUDE**

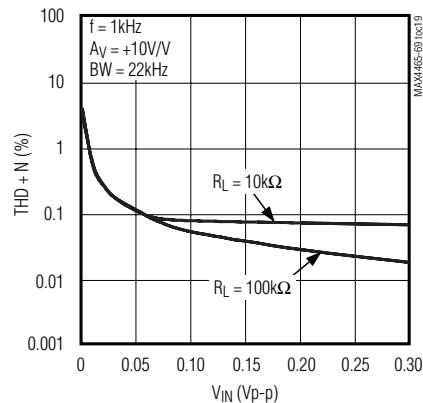

**NONINVERTING SMALL-SIGNAL  
TRANSIENT RESPONSE**

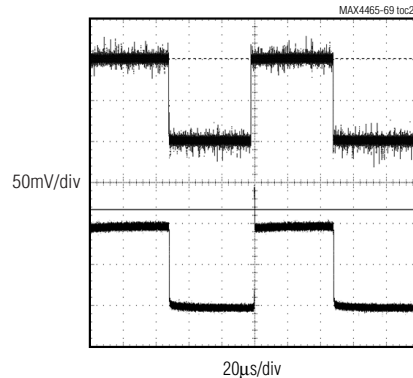

**NONINVERTING LARGE-SIGNAL  
TRANSIENT RESPONSE**

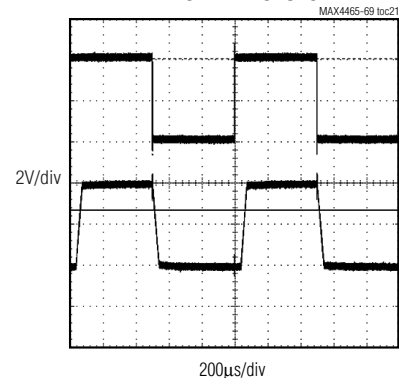

# Low-Cost, Micropower, SC70/SOT23-8, Microphone Preamplifiers with Complete Shutdown

## Typical Operating Characteristics (continued)

( $V_{CC} = +5V$ ,  $V_{CM} = 0V$ ,  $V_{OUT} = V_{CC}/2$ ,  $R_L = 100k\Omega$  to  $V_{CC}/2$ , SHDN = GND (MAX4467/MAX4468 only),  $T_A = +25^\circ C$ , unless otherwise noted.)

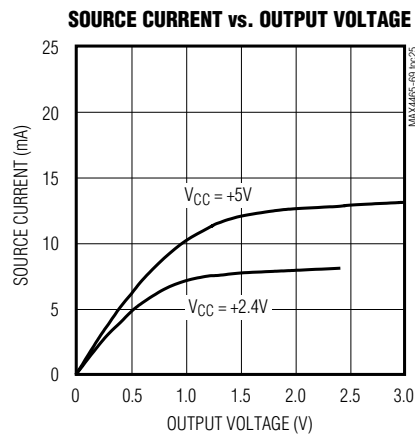
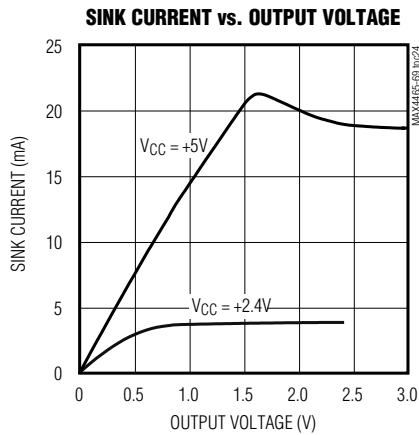
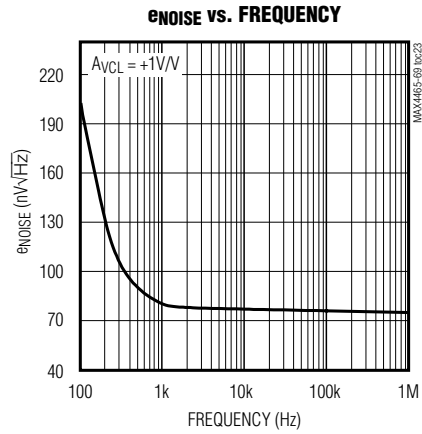
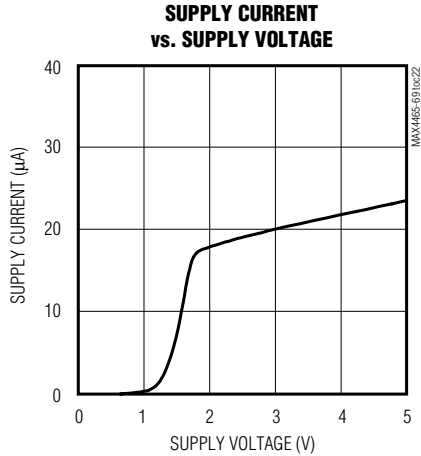

## Pin Description

PIN			NAME	FUNCTION
MAX4465 MAX4466	MAX4467 MAX4468	MAX4469		
4	6 (8)	—	OUT	Amplifier Output
—	—	1	OUTA	Amplifier Output A
—	1 (4)	—	MIC_BIAS	External Microphone Bias Network Switch Output
3	2 (3)	—	IN-	Inverting Amplifier Input
1	3 (2)	—	IN+	Noninverting Amplifier Input
2	4 (1)	4	GND	Ground

( ) denotes SOT23 package of the MAX4467/MAX4468

# Low-Cost, Micropower, SC70/SOT23-8, Microphone Preamplifiers with Complete Shutdown

MAX4465-MAX4469

## Pin Description (continued)

PIN			NAME	FUNCTION
MAX4465 MAX4466	MAX4467 MAX4468	MAX4469		
5	7 (7)	8	V <sub>CC</sub>	Positive Supply. Bypass with a 0.1μF capacitor to GND.
—	—	2	INA-	Inverting Amplifier Input A
—	—	3	INA+	Noninverting Amplifier Input A
—	—	6	INB-	Inverting Amplifier Input B
—	—	5	INB+	Noninverting Amplifier Input B
—	—	7	OUTB	Amplifier Output B
—	8 (6)	—	SHDN	Active-High Shutdown Input. Connect to GND for normal operation. Connect to V <sub>CC</sub> for shutdown. Do not leave unconnected.
—	5 (5)	—	N.C.	No Connection. Not internally connected.

( ) denotes SOT23 package of the MAX4467/MAX4468.

## Detailed Description

The MAX4465–MAX4469 are low-power, micropower op amps designed to be used as microphone preamplifiers. These preamplifiers are an excellent choice for noisy environments because of their high common-mode rejection and excellent power-supply rejection ratios. They operate from a single +2.4V to +5.5V supply.

The MAX4465/MAX4467/MAX4469 are unity-gain stable and deliver a 200kHz gain bandwidth from only 24μA of supply current. The MAX4466/MAX4468 have a minimum stable gain of +5V/V while providing a 600kHz gain bandwidth product.

The MAX4467/MAX4468 feature a complete shutdown, which is active-high, and a shutdown-controlled output providing bias to the microphone. The MAX4465/MAX4467/MAX4469 feature a slew rate suited to voice channel applications. The MAX4466/MAX4468 can be used for full-range audio, e.g., PC99 inputs.

### Rail-to-Rail Output Stage

The MAX4465–MAX4469 can drive a 10kΩ load and still typically swing within 16mV of the supply rails. Figure 1 shows the output voltage swing of the MAX4465 configured with A<sub>v</sub> = +10.

### Switched Bias Supply

When used as a microphone amplifier for an electret microphone, some form of DC bias for the microphone is necessary. The MAX4467/MAX4468 have the ability to

turn off the bias to the microphone when the device is in shutdown. This can save several hundred microamps of supply current, which can be significant in low power applications. The MIC\_BIAS pin provides a switched version of V<sub>CC</sub> to the bias components. Figure 3 shows some typical values.

### Driving Capacitive Loads

Driving a capacitive load can cause instability in many op amps, especially those with low quiescent current. The MAX4465/MAX4467/MAX4469 are unity-gain stable for a range of capacitive loads up to 100pF. Figure 4 shows the response of the MAX4465 with an excessive capacitive load.

## Applications Information

### Shutdown Mode

The MAX4467 and MAX4468 feature a low-power, complete shutdown mode. When SHDN goes high, the supply current drops to 5nA, the output enters a high impedance state and the bias current to the microphone is switched off. Pull SHDN low to enable the amplifier. Do not leave SHDN unconnected. Figure 5 shows the shutdown waveform.

### Common-Mode Rejection Ratio

A microphone preamplifier ideally only amplifies the signal present on its input and converts it to a voltage appearing at the output. When used in noninverting mode, there is a small output voltage fluctuation when both inputs experience the same voltage change in the

# Low-Cost, Micropower, SC70/SOT23-8, Microphone Preamplifiers with Complete Shutdown

common mode. The ratio of these voltages is called the common-mode gain. The common-mode rejection ratio is the ratio of differential-mode gain to common-mode gain. The high CMRR properties of the MAX4465-MAX4469 provide outstanding performances when configured as a noninverting microphone preamplifier.

### Power-Up

The MAX4465-MAX4469 outputs typically settle within 1 $\mu$ s after power-up. Figure 6 shows the output voltage on power-up.

### Power Supplies and Layout

The MAX4465-MAX4469 operate from a single +2.4V to +5.5V power supply. Bypass the power supply with a 0.1 $\mu$ F capacitor to ground. Good layout techniques are necessary for the MAX4465-MAX4469 family. To decrease stray capacitance, minimize trace lengths by placing external components close to the op amp's pins. Surface-mount components are recommended. In systems where analog and digital grounds are available, the MAX4465-MAX4469 should be connected to the analog ground.

### Test Circuits/Timing Diagrams

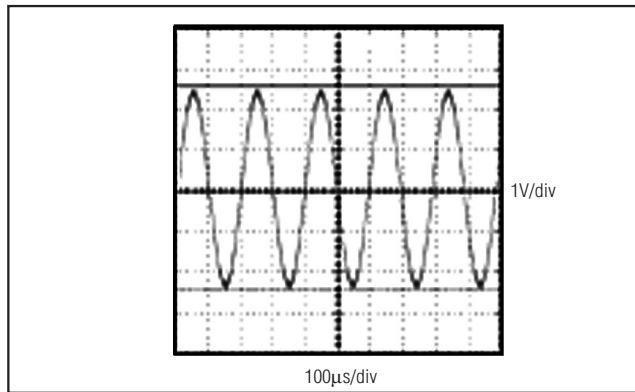

Figure 1. Rail-to-Rail Output Operation

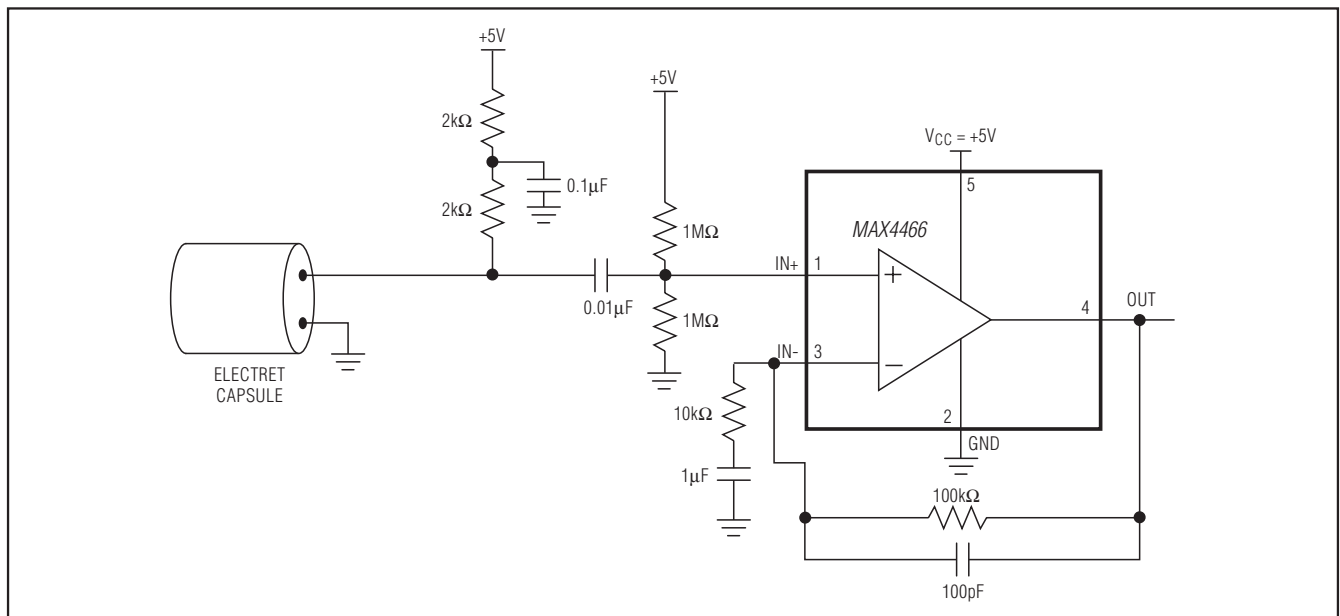

Figure 2. MAX4466 Typical Application Circuit

# Low-Cost, Micropower, SC70/SOT23-8, Microphone Preamplifiers with Complete Shutdown

## Test Circuits/Timing Diagrams (continued)

MAX4465-MAX4469

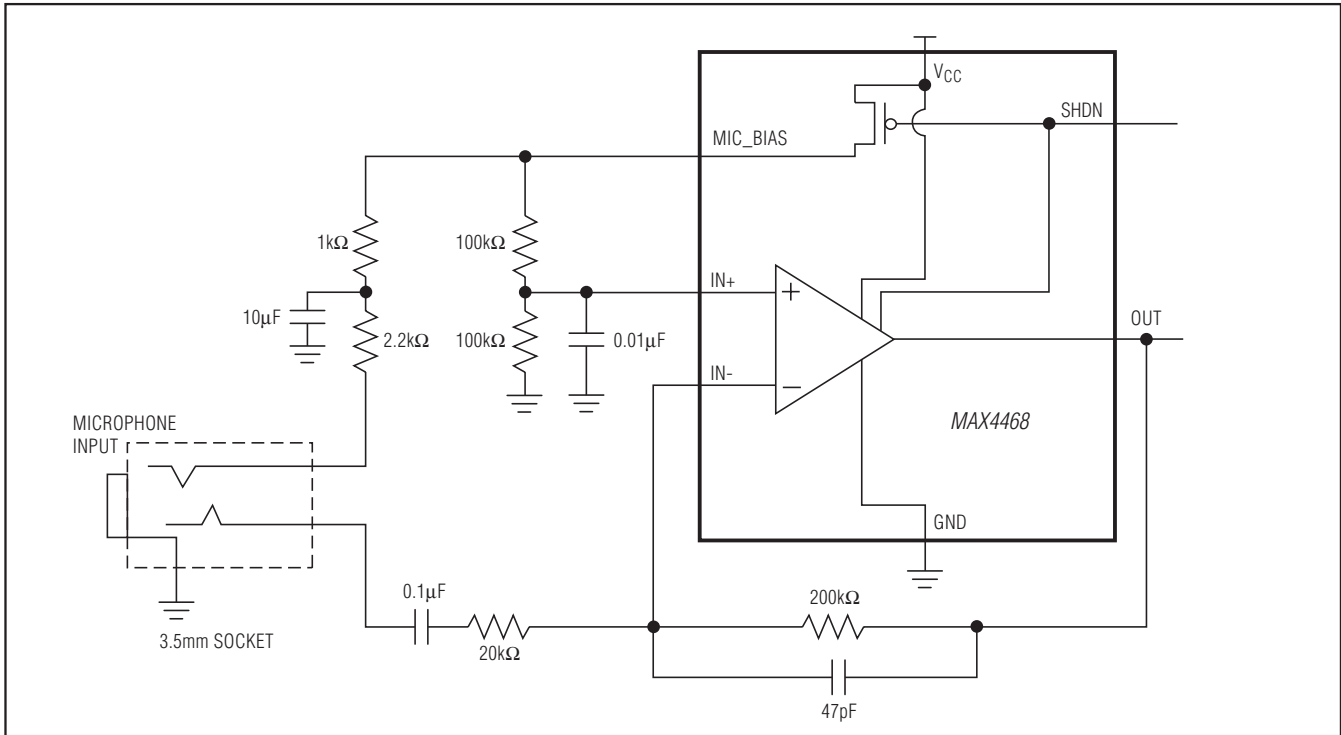

Figure 3. Bias Network Circuit

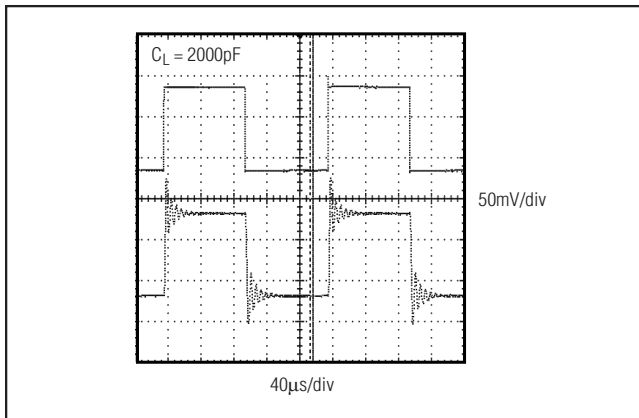

Figure 4. Small-Signal Transient Response with Excessive Capacitive Load

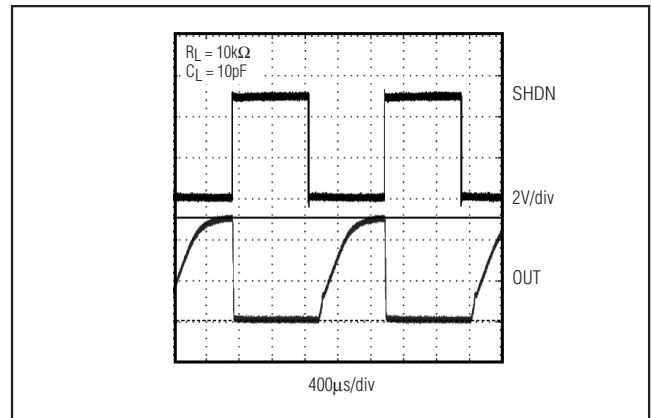

Figure 5. MAX4467/MAX4468 Shutdown Waveform

# Low-Cost, Micropower, SC70/SOT23-8, Microphone Preamplifiers with Complete Shutdown

## Test Circuits/Timing Diagrams (continued)

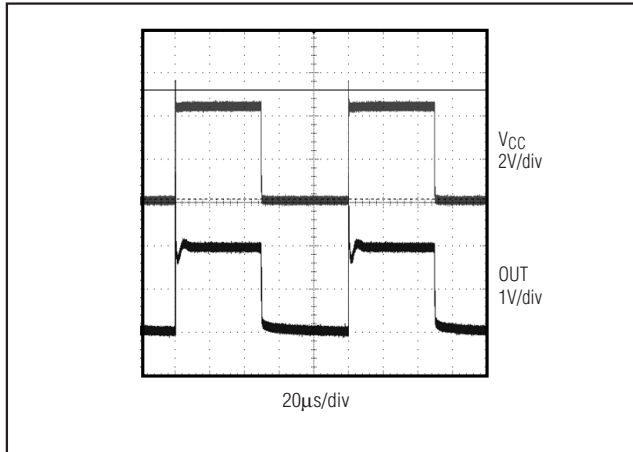

Figure 6. Power-Up/Power-Down Waveform

## Chip Information

PROCESS: BICMOS

## Ordering Information (continued)

PART	TEMP RANGE	PIN-PACKAGE
MAX4467EKA+T	-40°C to +85°C	8 SOT23
MAX4468EKA+T	-40°C to +85°C	8 SOT23
MAX4469EKA+T	-40°C to +85°C	8 SOT23

+Denotes a lead(Pb)-free/RoHS-compliant package.

## Selector Guide

PART	MINIMUM STABLE GAIN	EXTERNAL MICROPHONE SHDN	GBWP (kHz)	PIN-PACKAGE
MAX4465	+1	No	200	5 SC70/5 SOT23
MAX4466	+5	No	600	5 SC70/5 SOT23
MAX4467	+1	Yes	200	8 SOT23
MAX4468	+5	Yes	600	8 SOT23
MAX4469	+1	No	200	8 SOT23

## Pin Configurations (continued)

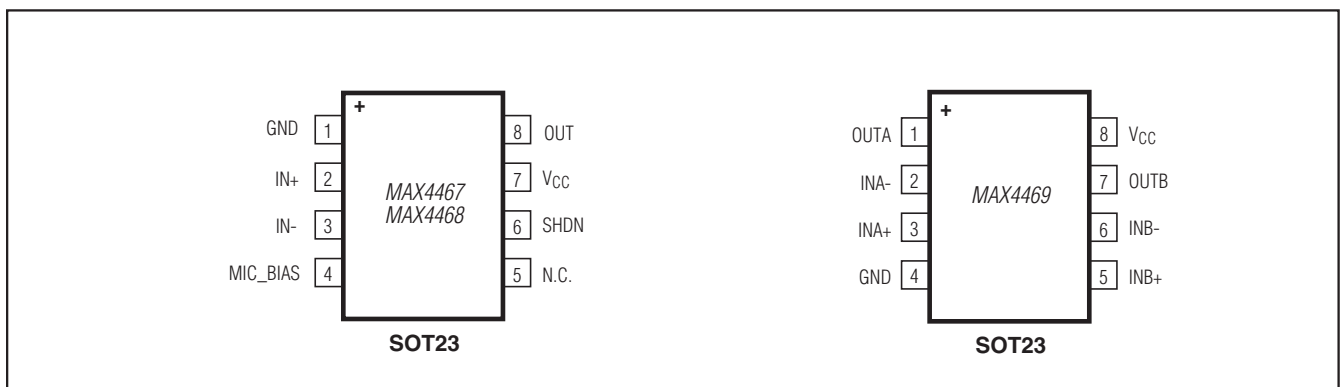

# Low-Cost, Micropower, SC70/SOT23-8, Microphone Preamplifiers with Complete Shutdown

## Package Information

For the latest package outline information and land patterns (footprints), go to [www.maxim-ic.com/packages](http://www.maxim-ic.com/packages). Note that a "+", "#", or "-" in the package code indicates RoHS status only. Package drawings may show a different suffix character, but the drawing pertains to the package regardless of RoHS status.

PACKAGE TYPE	PACKAGE CODE	OUTLINE NO.	LAND PATTERN NO.
SOT23-5	U5+1	<a href="#">21-0057</a>	<a href="#">90-0174</a>
SC70	X5+1	<a href="#">21-0076</a>	<a href="#">90-0188</a>
SOT23-8	K8+5	<a href="#">21-0078</a>	<a href="#">90-0176</a>

MAX4465-MAX4469

# **Low-Cost, Micropower, SC70/SOT23-8, Microphone Preamplifiers with Complete Shutdown**



## **Revision History**

<b>REVISION NUMBER</b>	<b>REVISION DATE</b>	<b>DESCRIPTION</b>	<b>PAGES CHANGED</b>
2	6/12	Added lead-free packaging information, removed SO packaging information	1, 2, 10

*Maxim cannot assume responsibility for use of any circuitry other than circuitry entirely embodied in a Maxim product. No circuit patent licenses are implied. Maxim reserves the right to change the circuitry and specifications without notice at any time. The parametric values (min and max limits) shown in the Electrical Characteristics table are guaranteed. Other parametric values quoted in this data sheet are provided for guidance.*

## Looking for pricing, stock, or lifecycle information?

Click below to explore more details on WIN SOURCE:

-  [View MAX4466EXK+T on WIN SOURCE](#)
-  [Maxim Integrated Information](#)

## Optimize Your Supply Chain with WIN SOURCE Solutions

-  Global Sourcing Solution
-  Obsolete Management
-  Cost Control Management
-  Shortage Management
-  Alternative Solution
-  Excess Inventory Management