



**THE DATASHEET OF  
MAX4147ESD+T**



**MAXIM**

# 300MHz, Low-Power, High-Output-Current, Differential Line Driver

## General Description

The MAX4147 differential line driver offers high-speed performance while consuming only 100mW of power. Its amplifier has fully symmetrical inputs and outputs and uses laser-trimmed, matched, thin-film resistors to deliver 70dB CMR at 10MHz. Using current-feedback techniques, the MAX4147 achieves a 300MHz bandwidth and a 2000V/ $\mu$ s slew rate.

Optimized for differential, high-output-current applications such as transformer drivers, the MAX4147 drives  $\pm 2.6V$  into a  $26.5\Omega$  load (single-ended) or  $\pm 5.6V$  into a  $53\Omega$  load (differential). This device is preset for a closed-loop gain of 2V/V. Its ultra-low 0.008%/0.03° differential gain/phase allow for a variety of video and RF signal-processing applications.

For power-sensitive applications, the MAX4147 has a shutdown function that reduces supply current to less than 1mA. In addition, superior SFDR (-82dBc at 10kHz,  $R_L = 33\Omega$ ) makes it ideal as a transformer driver for HDSL applications.

For a complete differential transmission link, use the MAX4147 with the MAX4144 line receiver (see the MAX4144 data sheet for more information).

## Applications

VDSL, ADSL, HDSL  
Video Twisted-Pair Driver  
Differential Pulse Amplifier  
Differential ADC Driver

## Typical Application Circuit

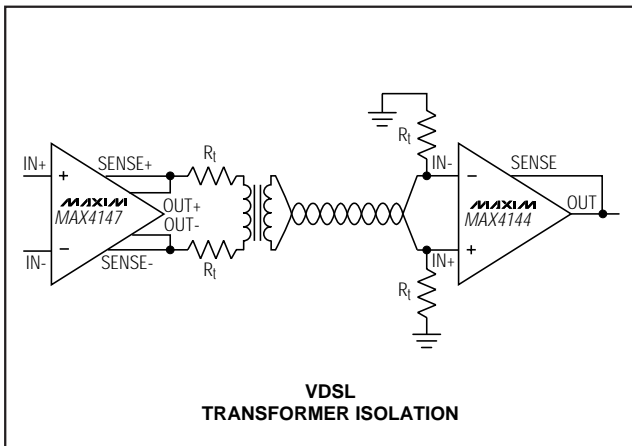

## Features

- ◆ 2V/V Fixed Gain
- ◆ 300MHz -3dB Bandwidth
- ◆ 2000V/ $\mu$ s Slew Rate
- ◆ 82dBc SFDR at 10kHz
- ◆ 70dB CMR at 10MHz
- ◆ Low Differential Gain/Phase: 0.008%/0.03°
- ◆ High Output Drive:  $\pm 5.6V$  into  $53\Omega$
- ◆ Low Power: 100mW

## Ordering Information

PART	TEMP. RANGE	PIN-PACKAGE
MAX4147ESD	-40°C to +85°C	14 SO

## Pin Configuration

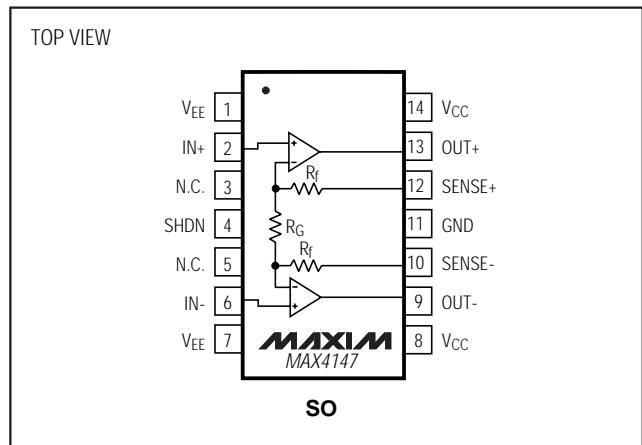
**MAXIM**

Maxim Integrated Products 1

For free samples & the latest literature: <http://www.maxim-ic.com>, or phone 1-800-998-8800.  
For small orders, phone 408-737-7600 ext. 3468.

MAX4147

# 300MHz, Low-Power, High-Output-Current, Differential Line Driver

## ABSOLUTE MAXIMUM RATINGS

Supply Voltage ( $V_{CC}$ to $V_{EE}$ )	12V	Operating Temperature Range	
Voltage on Any Input to Ground ( $V_{CC} + 0.3V$ ) to ( $V_{EE} - 0.3V$ )		MAX4147ESD	-40°C to +85°C
Continuous Power Dissipation ( $T_A = +70^\circ\text{C}$ )		Storage Temperature Range	-65°C to +160°C
SO (derate 8.33mW/°C above +70°C)	667mW	Lead Temperature (soldering, 10sec)	+300°C
Short-Circuit Duration	10sec		

Stresses beyond those listed under "Absolute Maximum Ratings" may cause permanent damage to the device. These are stress ratings only, and functional operation of the device at these or any other conditions beyond those indicated in the operational sections of the specifications is not implied. Exposure to absolute maximum rating conditions for extended periods may affect device reliability.

## ELECTRICAL CHARACTERISTICS

( $V_{CC} = +5V$ ,  $V_{EE} = -5V$ ,  $T_A = T_{MIN}$  to  $T_{MAX}$ , unless otherwise noted. Typical values are at  $T_A = +25^\circ\text{C}$ .)

PARAMETER	SYMBOL	CONDITIONS	MIN	TYP	MAX	UNITS
<b>DC SPECIFICATIONS</b>						
Input Offset Voltage	$V_{OS}$	$V_{OUT} = 0V$ , $R_L = \infty$		0.5	6	mV
Input Offset Voltage Drift	$TCV_{OS}$	$V_{OUT} = 0V$ , $R_L = \infty$		30		$\mu\text{V}/^\circ\text{C}$
Input Bias Current	$I_B$	$V_{OUT} = 0V$ , $R_L = \infty$ , $V_{IN} = -V_{OS}$		9	20	$\mu\text{A}$
Input Offset Current	$I_{OS}$	$V_{OUT} = 0V$ , $R_L = \infty$ , $V_{IN} = -V_{OS}$		0.03	2	$\mu\text{A}$
Input Voltage Noise	$e_n$	$f = 10\text{kHz}$		8		$\text{nV}/\sqrt{\text{Hz}}$
		$f = 1\text{MHz to } 100\text{MHz}$		80		$\mu\text{VRMS}$
Input Current Noise	$i_n$	$f = 10\text{kHz}$		1.7		$\text{pA}/\sqrt{\text{Hz}}$
		$f = 1\text{MHz to } 100\text{MHz}$		17		$\text{nARMS}$
Input Capacitance	$C_{IN}$			1		pF
Differential Input Resistance				1		$\text{M}\Omega$
Differential Input Voltage Range		$R_L = \infty$	-3.6		3.6	V
Common-Mode Input Voltage Range	$V_{CM}$	$R_L = \infty$	-2.8		2.8	V
Gain	$A_V$	$-1V \leq V_{OUT} \leq +1V$ , $R_L = 53\Omega$		2		V/V
Gain Error		$-1V \leq V_{OUT} \leq +1V$ , $R_L = 53\Omega$		0.3	1	%
Common-Mode Rejection	CMR	$V_{CM} = \pm 2.8V$	70	100		dB
Power-Supply Rejection	PSR	$V_S = \pm 4.5V$ to $\pm 5.5V$	70	100		dB
Quiescent Supply Current	$I_{SY}$	$V_{IN} = 0$ , $R_L = \infty$		10	13	mA
Shutdown Supply Current	$I_{SHDN}$	$V_{IN} = 0$ , $R_L = \infty$		0.6	1	mA
Output Voltage Swing	$ V_{OUT} $	Single-ended, $R_L = \infty$	3.2	3.8		V
		Differential, $R_L = \infty$	7.2	7.8		
		Single-ended, $R_L = 26.5\Omega$	2.2	2.6		
		Differential, $R_L = 53\Omega$	5.0	5.6		
Output Current Drive	$I_{OUT}$	$V_{OUT} = \pm 2.2V$	110	160		mA
SHDN High Threshold	$V_{IH}$				2.0	V
SHDN Low Threshold	$V_{IL}$			0.8		V
SHDN Input Current	$I_{SHDN}$	$V_{SHDN} \leq 0.8V$		75	150	$\mu\text{A}$
		$V_{SHDN} \geq 2V$		10		nA

# 300MHz, Low-Power, High-Output-Current, Differential Line Driver

MAX4147

## ELECTRICAL CHARACTERISTICS (continued)

( $V_{CC} = +5V$ ,  $V_{EE} = -5V$ ,  $T_A = T_{MIN}$  to  $T_{MAX}$ , unless otherwise noted. Typical values are at  $T_A = +25^{\circ}C$ .)

PARAMETER	SYMBOL	CONDITIONS	MIN	TYP	MAX	UNITS
<b>AC SPECIFICATIONS</b>						
-3dB Bandwidth	BW(-3dB)	$V_{OUT} \leq 0.1V_{RMS}$		300		MHz
Full-Power Bandwidth	FPBW	$V_{OUT} = 2V_{p-p}$		250		MHz
0.1dB Bandwidth	BW(0.1dB)	$V_{OUT} \leq 0.1V_{RMS}$		70		MHz
Common-Mode Rejection	CMR	$f = 10MHz$		70		dB
Slew Rate	SR	Differential, $-2V \leq V_{OUT} \leq +2V$		2000		V/ $\mu s$
Settling Time	$t_s$	$1V \leq V_{OUT} \leq +1V$ , $R_L = 150\Omega$ , $A_{VCL} = +2$	to 0.1%	10		ns
			to 0.01%	30		
Differential Gain	DG	$f = 3.58MHz$ , $R_L = 150\Omega$		0.008		%
Differential Phase	DP	$f = 3.58MHz$ , $R_L = 150\Omega$		0.03		degrees
Spurious-Free Dynamic Range	SFDR	$f_C = 10kHz$ , $V_{OUT} = 4.0V_{p-p}$ , $R_L = 33\Omega$ single-ended, $R_S = 50\Omega$ , Figure 1		-82		dBc
		$f_C = 5MHz$ , $V_{OUT} = 2V_{p-p}$ , $R_L = 150\Omega$ differential, Figure 2		-75		

# 300MHz, Low-Power, High-Output-Current, Differential Line Driver

## Typical Operating Characteristics

( $V_{CC} = +5V$ ,  $V_{EE} = -5V$ ,  $R_L = 150\Omega$ ,  $T_A = +25^\circ C$ , unless otherwise noted.)

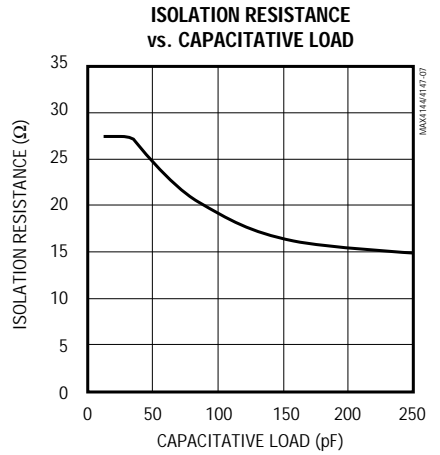
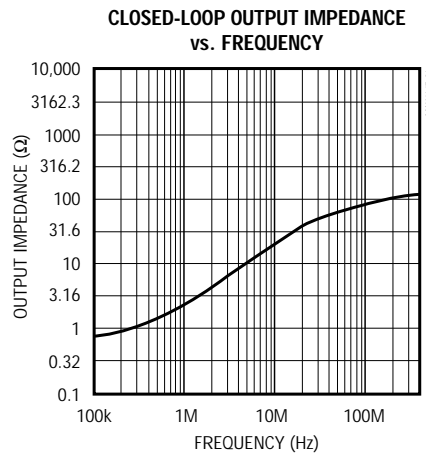
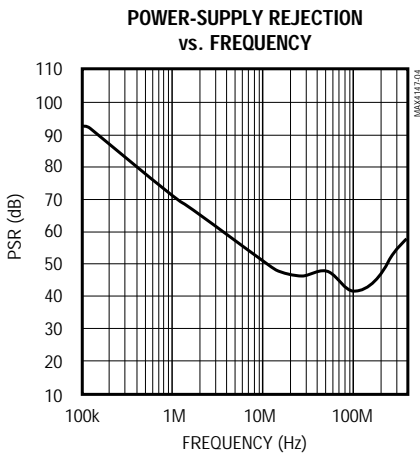
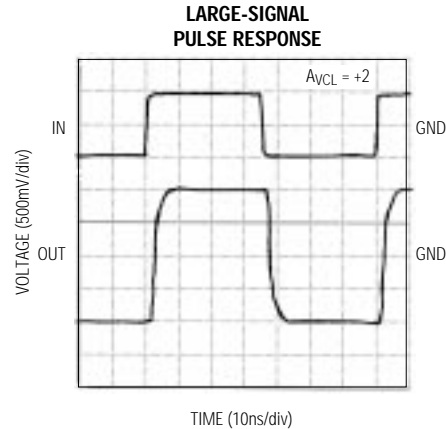
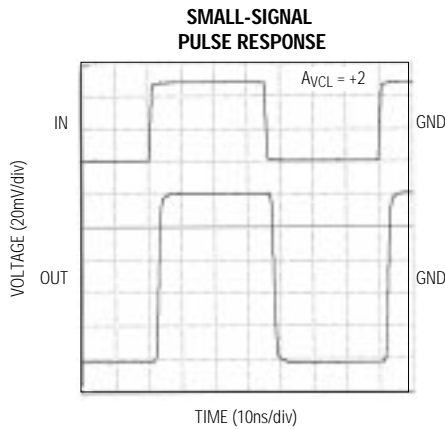
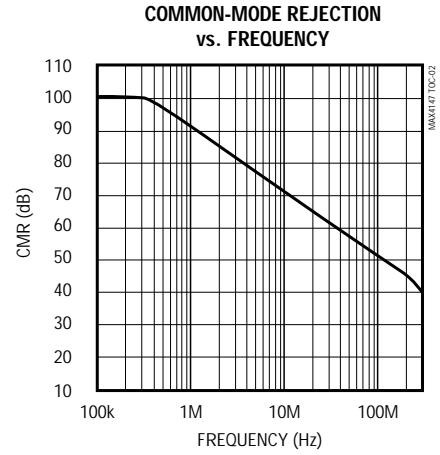
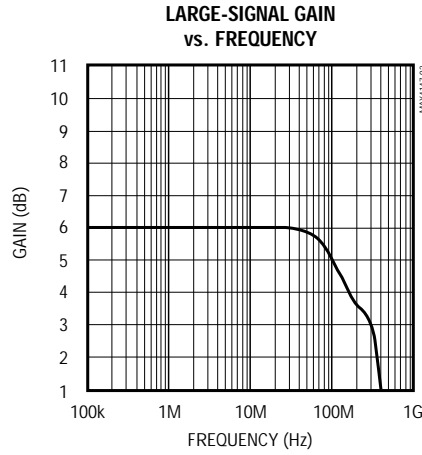
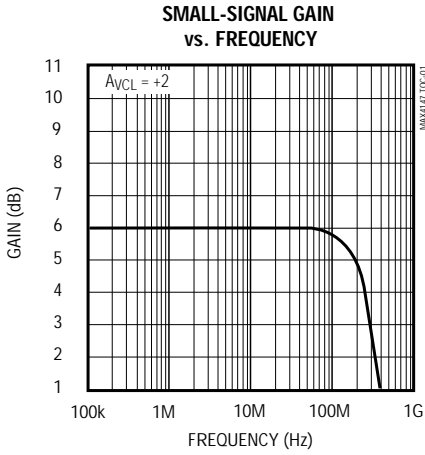

# 300MHz, Low-Power, High-Output-Current, Differential Line Driver

MAX4147

Typical Operating Characteristics (continued)  
 ( $V_{CC} = +5V$ ,  $V_{EE} = -5V$ ,  $R_L = 150\Omega$ ,  $T_A = +25^\circ C$ , unless otherwise noted.)

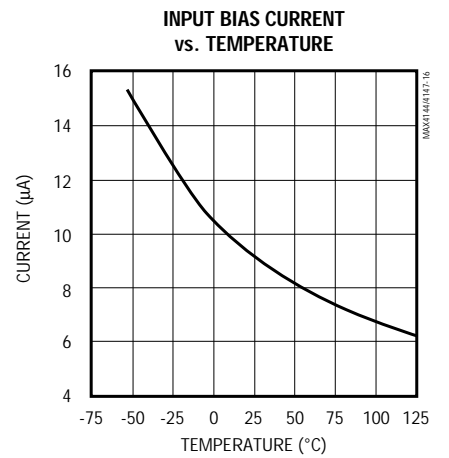
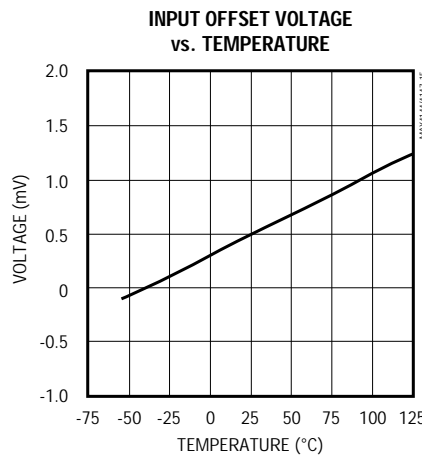
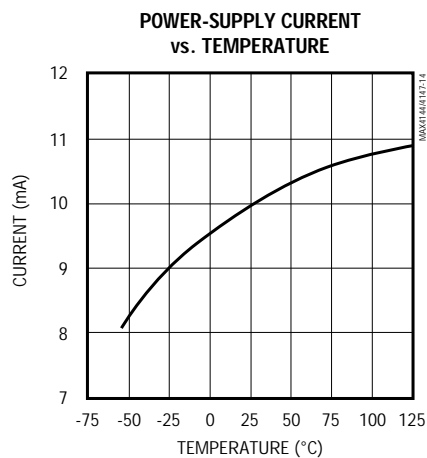
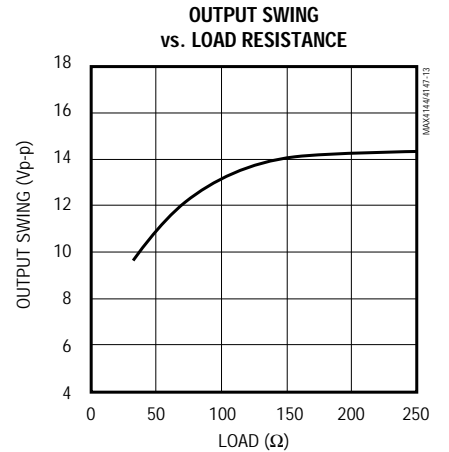
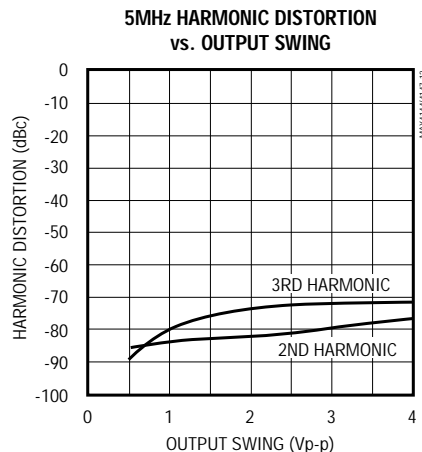
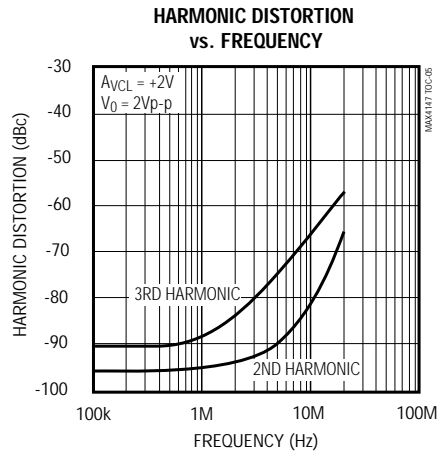
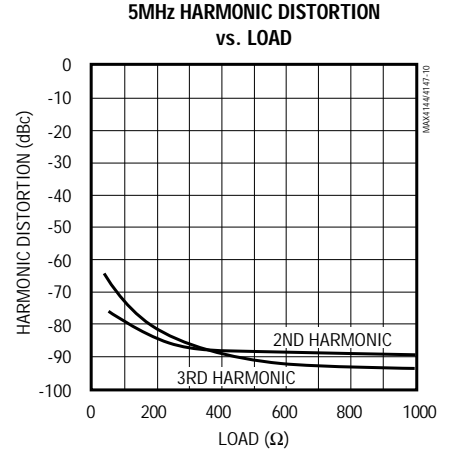
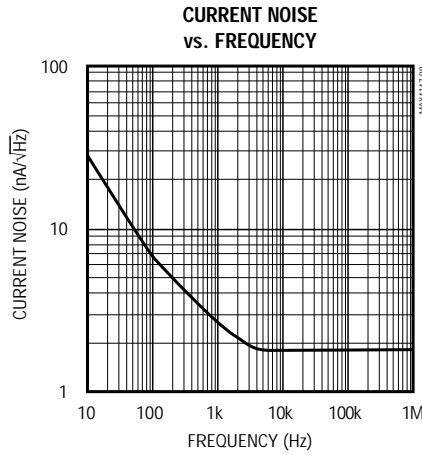
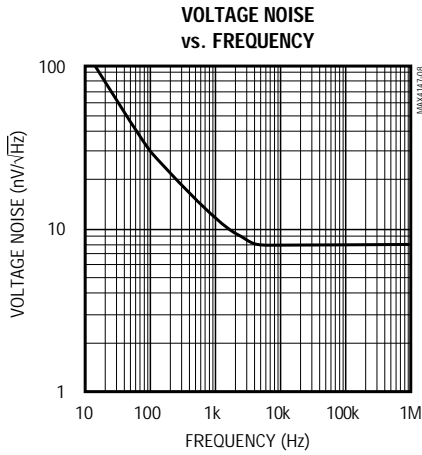

# 300MHz, Low-Power, High-Output-Current, Differential Line Driver

Typical Operating Characteristics (continued)

( $V_{CC} = +5V$ ,  $V_{EE} = -5V$ ,  $R_L = 150\Omega$ ,  $T_A = +25^\circ C$ , unless otherwise noted.)

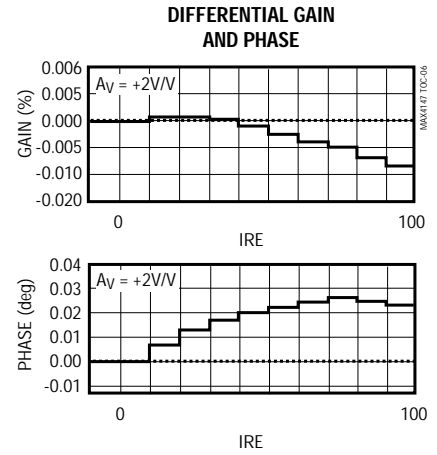
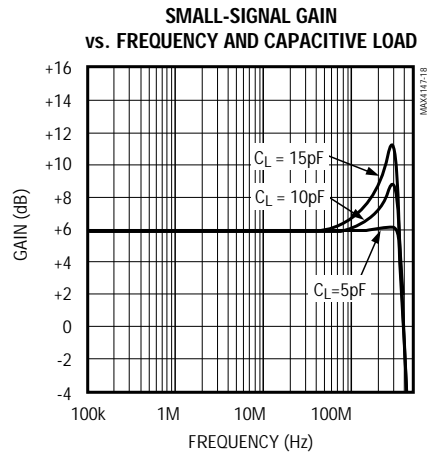
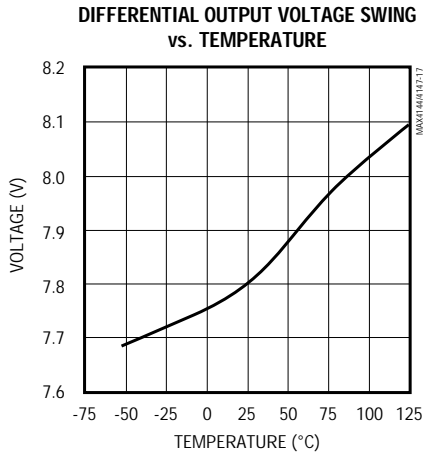

## Pin Description

PIN	NAME	FUNCTION
1, 7	$V_{EE}$	Negative Power Supply. Connect to -5V.
2	IN+	Noninverting Input
3, 5	N.C.	No Connect. Not internally connected.
4	SHDN	Logic Input for Shutdown Circuitry. A logic low enables the amplifier. A logic high disables the amplifier. The amplifier outputs are high impedance in shutdown mode; thus the impedances seen at OUT+ and OUT- are that of the feedback resistors and the protection circuitry (Figure 3).
6	IN-	Inverting Input
8, 14	$V_{CC}$	Positive Power Supply
9	OUT-	Inverting Output
10	SENSE-	Sense Line for the Inverting Output. Connect to OUT-, close to the pin.
11	GND	Ground
12	SENSE+	Sense Line for the Noninverting Output. Connect to OUT+, close to the pin.
13	OUT+	Noninverting Output

# 300MHz, Low-Power, High-Output-Current, Differential Line Driver

MAX4147

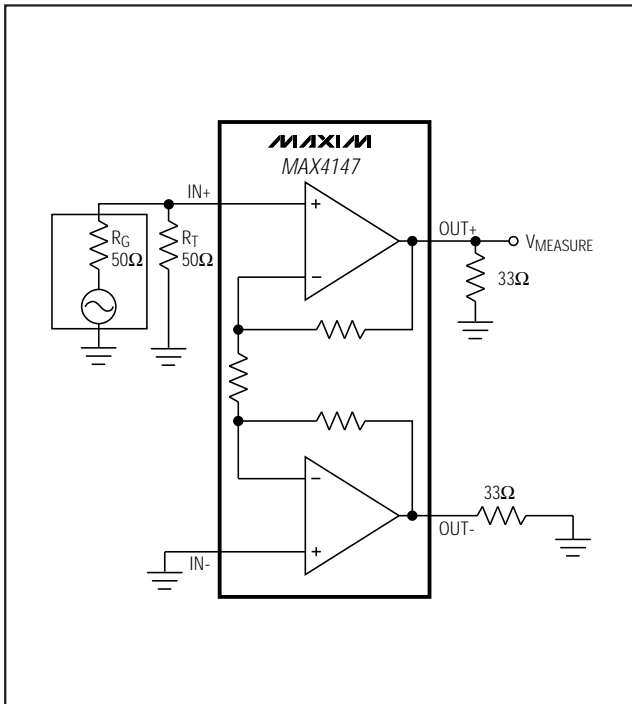

Figure 1. Single-Ended Distortion Setup

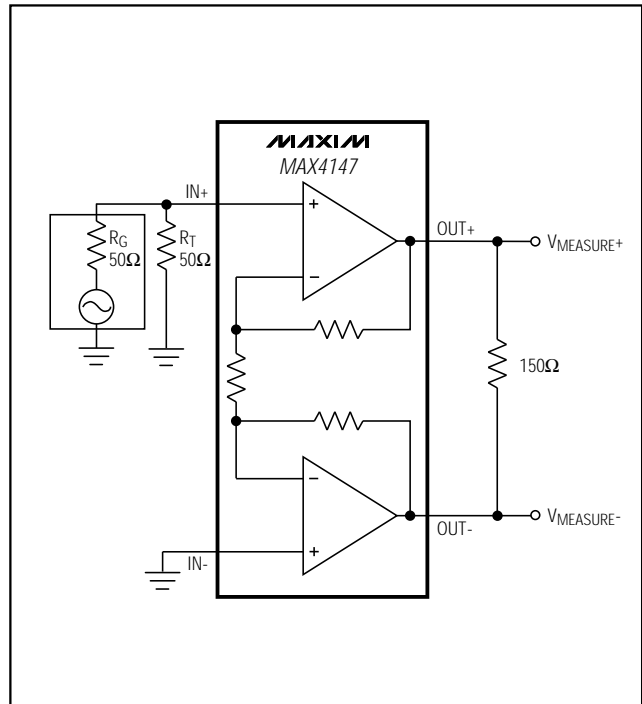

Figure 2. Differential Distortion Setup

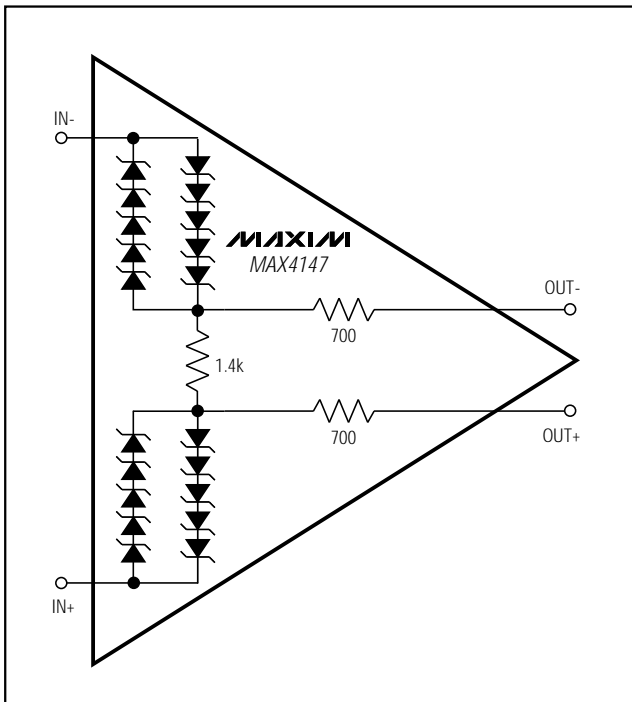
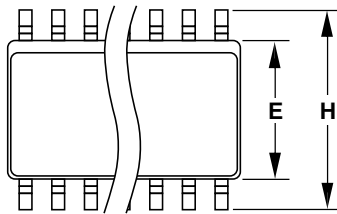
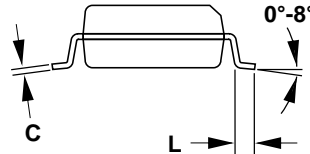
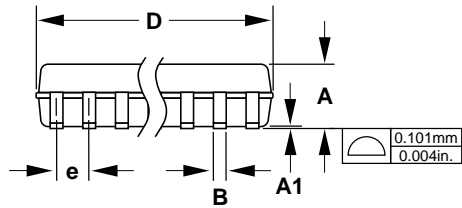

Figure 3. MAX4147 Shutdown Equivalent Circuit

# 300MHz, Low-Power, High-Output-Current, Differential Line Driver

## Package Information



**Narrow SO  
SMALL-OUTLINE  
PACKAGE  
(0.150 in.)**

DIM	INCHES		MILLIMETERS	
	MIN	MAX	MIN	MAX
A	0.053	0.069	1.35	1.75
A1	0.004	0.010	0.10	0.25
B	0.014	0.019	0.35	0.49
C	0.007	0.010	0.19	0.25
E	0.150	0.157	3.80	4.00
e	0.050		1.27	
H	0.228	0.244	5.80	6.20
L	0.016	0.050	0.40	1.27

DIM	PINS	INCHES		MILLIMETERS	
		MIN	MAX	MIN	MAX
D	8	0.189	0.197	4.80	5.00
D	14	0.337	0.344	8.55	8.75
D	16	0.386	0.394	9.80	10.00



21-0041A

Maxim cannot assume responsibility for use of any circuitry other than circuitry entirely embodied in a Maxim product. No circuit patent licenses are implied. Maxim reserves the right to change the circuitry and specifications without notice at any time.

8 Maxim Integrated Products, 120 San Gabriel Drive, Sunnyvale, CA 94086 408-737-7600

## Looking for pricing, stock, or lifecycle information?

Click below to explore more details on WIN SOURCE:

-  [View MAX4147ESD+T on WIN SOURCE](#)
-  [Maxim Integrated Information](#)

## Optimize Your Supply Chain with WIN SOURCE Solutions

-  Global Sourcing Solution
-  Obsolete Management
-  Cost Control Management
-  Shortage Management
-  Alternative Solution
-  Excess Inventory Management