



**THE DATASHEET OF  
MAX4080TAUA+**



Click [here](#) to ask about the production status of specific part numbers.

## MAX4080/MAX4081

## 76V, High-Side, Current-Sense Amplifiers with Voltage Output

### General Description

The MAX4080/MAX4081 are high-side, current-sense amplifiers with an input voltage range that extends from 4.5V to 76V making them ideal for telecom, automotive, backplane, and other systems where high-voltage current monitoring is critical. The MAX4080 is designed for unidirectional current-sense applications and the MAX4081 allows bidirectional current sensing. The MAX4081 single output pin continuously monitors the transition from charge to discharge and avoids the need for a separate polarity output. The MAX4081 requires an external reference to set the zero-current output level ( $V_{SENSE} = 0V$ ). The charging current is represented by an output voltage from  $V_{REF}$  to  $V_{CC}$ , while discharge current is given from  $V_{REF}$  to GND.

For maximum versatility, the 76V input voltage range applies independently to both supply voltage ( $V_{CC}$ ) and common-mode input voltage ( $V_{RS+}$ ). High-side current monitoring does not interfere with the ground path of the load being measured, making the MAX4080/MAX4081 particularly useful in a wide range of high-voltage systems.

The combination of three gain versions (5V/V, 20V/V, 60V/V = F, T, S suffix) and a user-selectable, external sense resistor sets the full-scale current reading and its proportional output voltage. The MAX4080/MAX4081 offer a high level of integration, resulting in a simple, accurate, and compact current-sense solution.

The MAX4080/MAX4081 operate from a 4.5V to 76V single supply and draw only 75 $\mu$ A of supply current. These devices are specified over the automotive operating temperature range (-40°C to +125°C) and are available in a space-saving 8-pin  $\mu$ MAX® or SO package.

### Applications

- Automotive (12V, 24V, or 42V Batteries)
- 48V Telecom and Backplane Current Measurement
- Bidirectional Motor Control
- Power-Management Systems
- Avalanche Photodiode and PIN-Diode Current Monitoring
- General System/Board-Level Current Sensing
- Precision High-Voltage Current Sources

$\mu$ MAX is a registered trademark of Maxim Integrated Products, Inc.

### Benefits and Features

- Ideal for High-Voltage Current Monitoring Applications
  - Wide 4.5V to 76V Input Common-Mode Range
  - Independent Operating Supply Voltage
- High Accuracy and Low Quiescent Current Support Precision Application Requirements
  - $\pm 0.1\%$  Full-Scale Accuracy
  - Low 100 $\mu$ V Input Offset Voltage
  - Three Gain Versions Available
    - 5V/V (MAX4080F/MAX4081F)
    - 20V/V (MAX4080T/MAX4081T)
    - 60V/V (MAX4080S/MAX4081S)
  - 75 $\mu$ A Supply Current (MAX4080)
- Flexible Current Sensing Supports Monitoring of Charge and Discharge of Batteries
  - Bidirectional (MAX4081) or Unidirectional (MAX4080)  $I_{SENSE}$
  - Reference Input for Bidirectional OUT (MAX4081)
- Minimizes Required Board Space
  - 8-Pin  $\mu$ MAX Package

### Ordering Information

PART	TEMP RANGE	PIN-PACKAGE
MAX4080FAUA+	-40°C to +125°C	8 $\mu$ MAX
MAX4080FAUA/V+	-40°C to +125°C	8 $\mu$ MAX
MAX4080FASA+	-40°C to +125°C	8 SO
MAX4080TAUA+	-40°C to +125°C	8 $\mu$ MAX
MAX4080TAUA/V+	-40°C to +125°C	8 $\mu$ MAX

+Denotes a lead(Pb)-free/RoHS-compliant package.

/V denotes an automotive qualified part.

Ordering Information continued at end of data sheet.

Selector Guide appears at end of data sheet.

### Pin Configurations

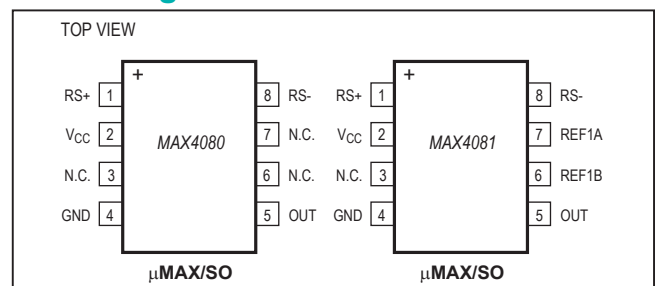

**Absolute Maximum Ratings**

V <sub>CC</sub> to GND .....	-0.3V to +80V	Continuous Power Dissipation (T <sub>A</sub> = +70°C)
RS+, RS- to GND .....	-0.3V to +80V	8-Pin ?MAX (derate 4.5mW/°C above +70°C).....
OUT to GND .....	-0.3V to the lesser of +18V or (V <sub>CC</sub> + 0.3V)	8-Pin SO (derate 5.88mW/°C above +70°C).....
REF1A, REF1B to GND		Operating Temperature Range.....
(MAX4081 Only) -0.3V to the lesser of +18V or (V <sub>CC</sub> + 0.3V)		Junction Temperature.....
Output Short Circuit to GND.....	Continuous	Storage Temperature Range.....
Differential Input Voltage (V <sub>RS+</sub> - V <sub>RS-</sub> ).....	±80V	Lead Temperature (soldering, 10s).....
Current into Any Pin .....	±20mA	Soldering Temperature (reflow).....

Stresses beyond those listed under "Absolute Maximum Ratings" may cause permanent damage to the device. These are stress ratings only, and functional operation of the device at these or any other conditions beyond those indicated in the operational sections of the specifications is not implied. Exposure to absolute maximum rating conditions for extended periods may affect device reliability.

**DC Electrical Characteristics**

(V<sub>CC</sub> = V<sub>RS+</sub> = 4.5V to 76V, V<sub>REF1A</sub> = V<sub>REF1B</sub> = 5V (MAX4081 only), V<sub>SENSE</sub> = (V<sub>RS+</sub> - V<sub>RS-</sub>) = 0V, R<sub>LOAD</sub> = 100kΩ, T<sub>A</sub> = T<sub>MIN</sub> to T<sub>MAX</sub>, unless otherwise noted. Typical values are at T<sub>A</sub> = +25°C.) (Notes 1, 2)

PARAMETER	SYMBOL	CONDITIONS	MIN	TYP	MAX	UNITS	
Operating Voltage Range	V <sub>CC</sub>	Inferred from PSRR test	4.5		76	V	
Common-Mode Range	CMVR	Inferred from CMRR test (Note 3)	4.5		76	V	
Supply Current	I <sub>CC</sub>	V <sub>CC</sub> = V <sub>RS+</sub> = 76V, no load	MAX4080		75	190	µA
			MAX4081		103	190	
Leakage Current	IRS+, IRS-	V <sub>CC</sub> = 0V, V <sub>RS+</sub> = 76V		0.01	2	µA	
Input Bias Current	IRS+, IRS-	V <sub>CC</sub> = V <sub>RS+</sub> = 76V		5	12	µA	
Full-Scale Sense Voltage (Note 4)	V <sub>SENSE</sub>	MAX4080F/MAX4081F		±1000		mV	
		MAX4080T/MAX4081T		±250			
		MAX4080S/MAX4081S		±100			
Gain	A <sub>V</sub>	MAX4080F/MAX4081F		5		V/V	
		MAX4080T/MAX4081T		20			
		MAX4080S/MAX4081S		60			
Gain Accuracy	ΔA <sub>V</sub>	V <sub>CC</sub> = V <sub>RS+</sub> = 48V (Note 5)	TA = +25°C	±0.1	±0.6	%	
			TA = -40°C to +85°C		±1		
			TA = T <sub>MIN</sub> to T <sub>MAX</sub>		±1.2		
Input Offset Voltage	V <sub>OS</sub>	V <sub>CC</sub> = V <sub>RS+</sub> = 48V (Note 6)	TA = +25°C	±0.1	±0.6	mV	
			TA = -40°C to +85°C		±1		
			TA = T <sub>MIN</sub> to T <sub>MAX</sub>		±1.2		
Common-Mode Rejection Ratio (Note 7)	CMRR	V <sub>CC</sub> = 48V, V <sub>RS+</sub> = 4.5V to 76V	100	124		dB	
Power-Supply Rejection Ratio (Note 7)	PSRR	V <sub>RS+</sub> = 48V, V <sub>CC</sub> = 4.5V to 76V	100	122		dB	
OUT High Voltage	(V <sub>CC</sub> - V <sub>OH</sub> )	V <sub>CC</sub> = 4.5V, V <sub>RS+</sub> = 48V, V <sub>REF1A</sub> = V <sub>REF1B</sub> = 2.5V, I <sub>OUT</sub> (sourcing) = +500µA (Note 8)	MAX4080F/MAX4081F, V <sub>SENSE</sub> = 1000mV		0.15	0.27	V
			MAX4080T/MAX4081T, V <sub>SENSE</sub> = 250mV				
			MAX4080S/MAX4081S, V <sub>SENSE</sub> = 100mV				

**DC Electrical Characteristics (continued)**

( $V_{CC} = V_{RS+} = 4.5V$  to  $76V$ ,  $V_{REF1A} = V_{REF1B} = 5V$  (MAX4081 only),  $V_{SENSE} = (V_{RS+} - V_{RS-}) = 0V$ ,  $R_{LOAD} = 100k\Omega$ ,  $T_A = T_{MIN}$  to  $T_{MAX}$ , unless otherwise noted. Typical values are at  $T_A = +25^\circ C$ .) (Notes 1, 2)

PARAMETER	SYMBOL	CONDITIONS	MIN	TYP	MAX	UNITS
OUT Low Voltage	VOL	$V_{CC} = V_{RS+} = 48V$ , $V_{REF1A} = V_{REF1B} = 2.5V$ , $V_{SENSE} = -1000mV$ (for MAX4081 only)		IOUT (sinking) = $10\mu A$		
		IOUT (sinking) = $100\mu A$				
REF1A = REF1B Input Voltage Range (MAX4081 Only)	$(V_{REF} - V_{GND})$	Inferred from REF1A rejection ratio, $V_{REF1A} = V_{REF1B}$	1.5		6	V
REF1A Input Voltage Range (MAX4081 Only)	$(V_{REF1A} - V_{GND})$	Inferred from REF1A rejection ratio, $V_{REF1B} = V_{GND}$	3		12	V
REF1A Rejection Ratio (MAX4081 Only)		$V_{CC} = V_{RS+} = 48V$ , $V_{SENSE} = 0V$ , $V_{REF1A} = V_{REF1B} = 1.5V$ to $6V$	80	108		dB
REF/REF1A Ratio (MAX4081 Only)		$V_{REF1A} = 10V$ , $V_{REF1B} = V_{GND}$ , $V_{CC} = V_{RS+} = 48V$ (Note 2)	0.497	0.500	0.503	
REF1A Input Impedance (MAX4081 Only)		$V_{REF1B} = V_{GND}$		250		$k\Omega$

## AC Electrical Characteristics

( $V_{CC} = V_{RS+} = 4.5V$  to  $76V$ ,  $V_{REF1A} = V_{REF1B} = 5V$  (MAX4081 only),  $V_{SENSE} = (V_{RS+} - V_{RS-}) = 0V$ ,  $R_{LOAD} = 100k\Omega$ ,  $C_{LOAD} = 20pF$ ,  $T_A = T_{MIN}$  to  $T_{MAX}$ , unless otherwise noted. Typical values are at  $T_A = +25^\circ C$ .) (Notes 1, 2)

PARAMETER	SYMBOL	CONDITION	MIN	TYP	MAX	UNITS	
Bandwidth	BW	$V_{CC} = V_{RS+} = 48V$ , $V_{OUT} = 2.5V$	MAX4080F/T/S		250		kHz
			MAX4081F/T/S		150		
OUT Settling Time to 1% of Final Value		$V_{SENSE} = 10mV$ to $100mV$		20		$\mu s$	
		$V_{SENSE} = 100mV$ to $10mV$		20			
Capacitive-Load Stability		No sustained oscillations		500		pF	
Output Resistance	$R_{OUT}$	$V_{SENSE} = 100mV$		0.1		$\Omega$	
Power-Up Time		$V_{CC} = V_{RS+} = 48V$ , $V_{SENSE} = 100mV$ (Note 9)		50		$\mu s$	
Saturation Recovery Time		(Notes 9,10)		50		$\mu s$	

**Note 1:** All devices are 100% production tested at  $T_A = +25^\circ C$ . All temperature limits are guaranteed by design.

**Note 2:**  $V_{REF}$  is defined as the average voltage of  $V_{REF1A}$  and  $V_{REF1B}$ .  $REF1B$  is usually connected to  $REF1A$  or  $GND$ .  
 $V_{SENSE}$  is defined as  $V_{RS+} - V_{RS-}$ .

**Note 3:** The common-mode range at the low end of  $4.5V$  applies to the most positive potential at  $RS+$  or  $RS-$ . Depending on the polarity of  $V_{SENSE}$  and the device's gain, either  $RS+$  or  $RS-$  can extend below  $4.5V$  by the device's typical full-scale value of  $V_{SENSE}$ .

**Note 4:** Negative  $V_{SENSE}$  applies to MAX4081 only.

**Note 5:**  $V_{SENSE}$  is:  
MAX4080F,  $10mV$  to  $1000mV$   
MAX4080T,  $10mV$  to  $250mV$   
MAX4080S,  $10mV$  to  $100mV$   
MAX4081F,  $-500mV$  to  $+500mV$   
MAX4081T,  $-125mV$  to  $+125mV$   
MAX4081S,  $-50mV$  to  $+50mV$

**Note 6:**  $V_{OS}$  is extrapolated from the gain accuracy test for the MAX4080 and measured as  $(V_{OUT} - V_{REF})/AV$  at  $V_{SENSE} = 0V$ , for the MAX4081.

**Note 7:**  $V_{SENSE}$  is:  
MAX4080F,  $500mV$   
MAX4080T,  $125mV$   
MAX4080S,  $50mV$   
MAX4081F/T/S,  $0V$   
 $V_{REF1B} = V_{REF1A} = 2.5V$

**Note 8:** Output voltage is internally clamped not to exceed  $18V$ .

**Note 9:** Output settles to within 1% of final value.

**Note 10:** The device will not experience phase reversal when overdriven.

Typical Operating Characteristics

( $V_{CC} = V_{RS+} = 48V$ ,  $V_{SENSE} = 0V$ ,  $C_{LOAD} = 20pF$ ,  $R_{LOAD} = \infty$ ,  $T_A = +25^{\circ}C$ , unless otherwise noted.)

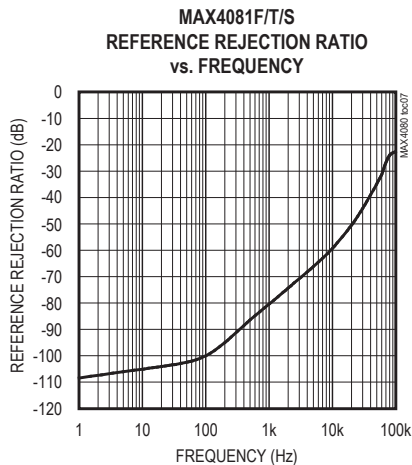
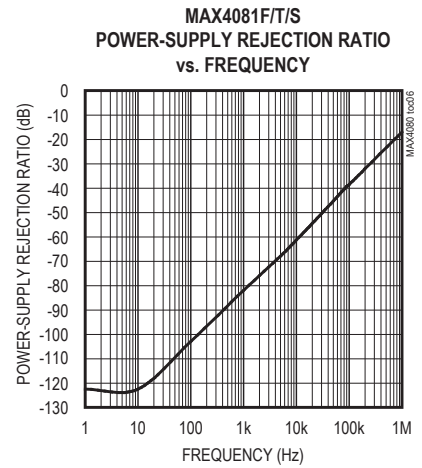
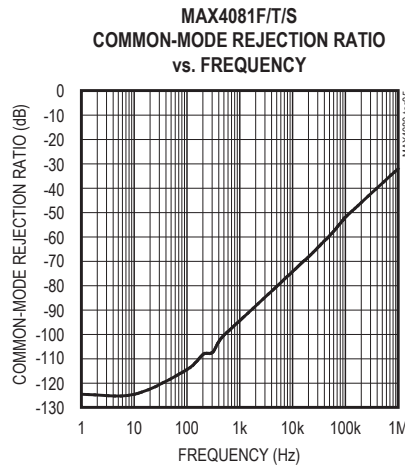
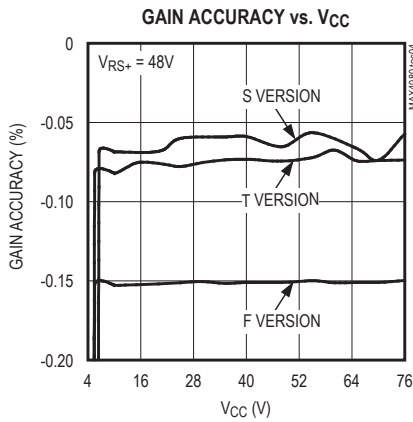
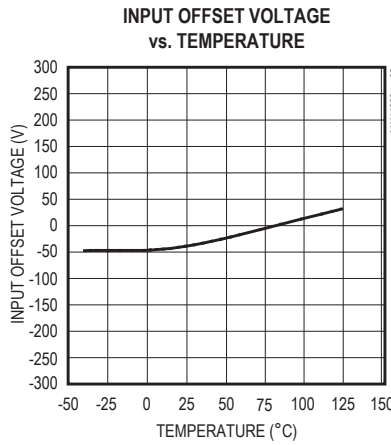
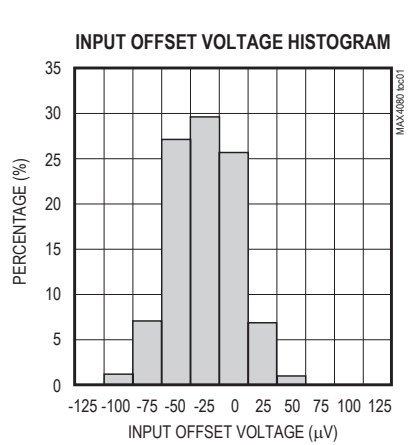

Typical Operating Characteristics (continued)

( $V_{CC} = V_{RS+} = 48V$ ,  $V_{SENSE} = 0V$ ,  $C_{LOAD} = 20pF$ ,  $R_{LOAD} = \infty$ ,  $T_A = +25^\circ C$ , unless otherwise noted.)

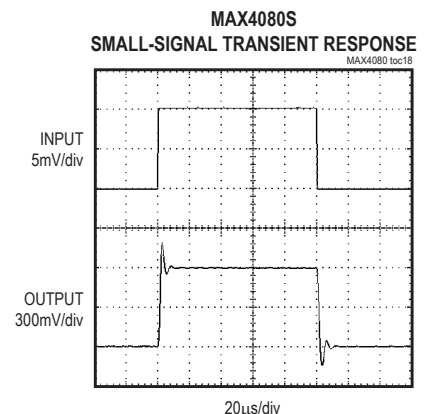
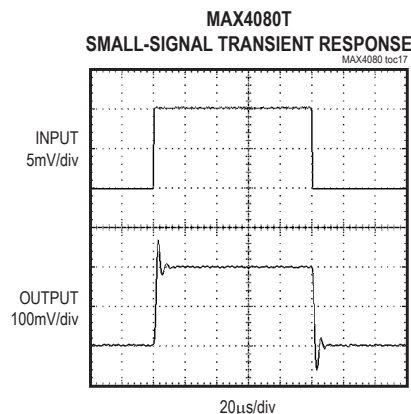
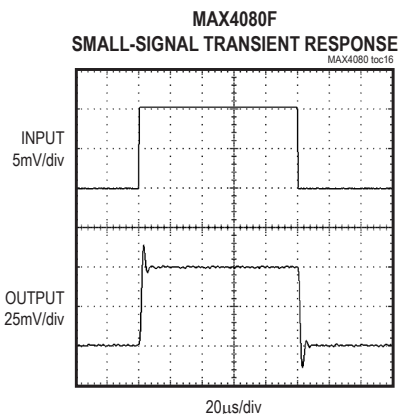
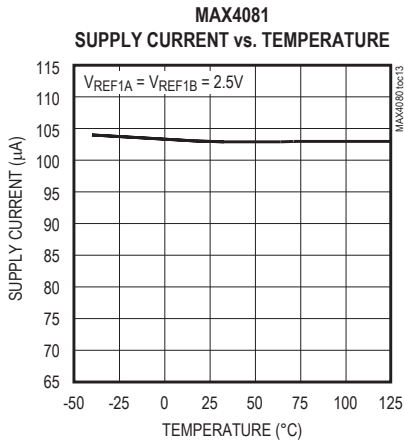
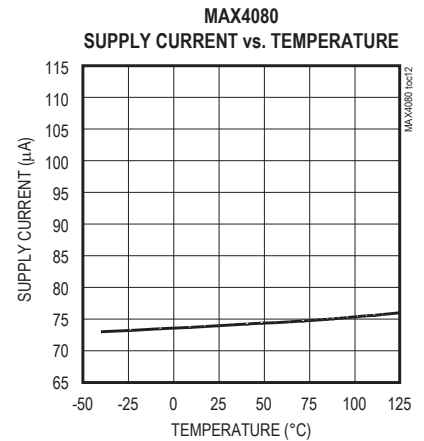
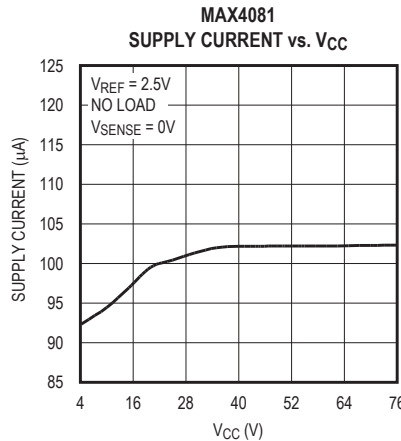
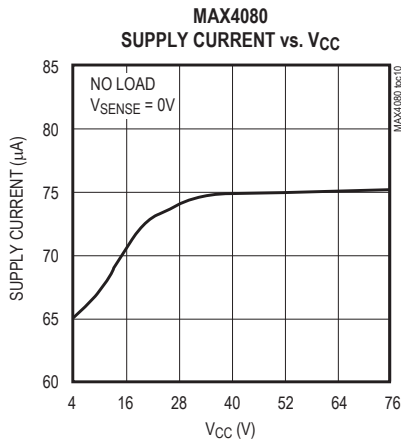

Typical Operating Characteristics (continued)

( $V_{CC} = V_{RS+} = 48V$ ,  $V_{SENSE} = 0V$ ,  $C_{LOAD} = 20pF$ ,  $R_{LOAD} = \infty$ ,  $T_A = +25^{\circ}C$ , unless otherwise noted.)

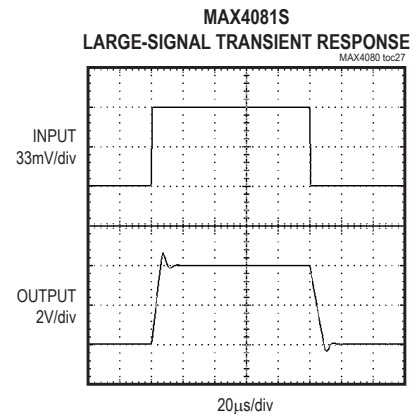
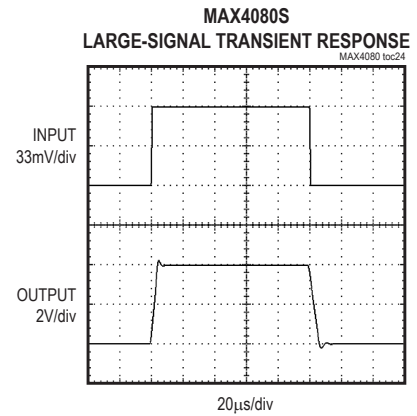
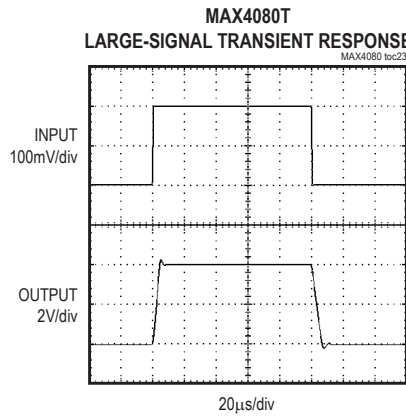
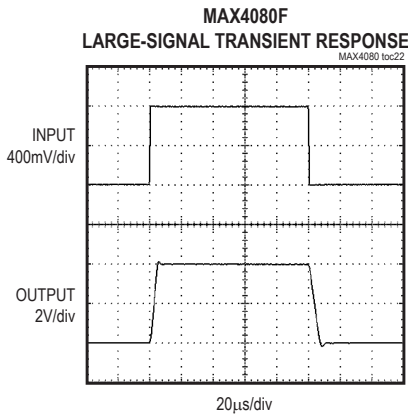
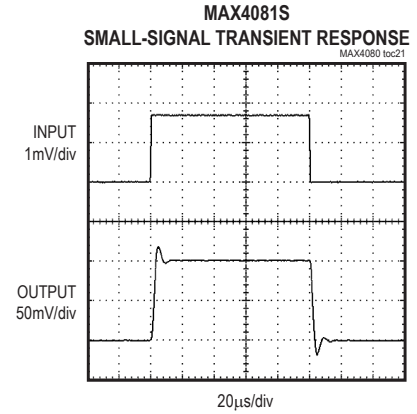
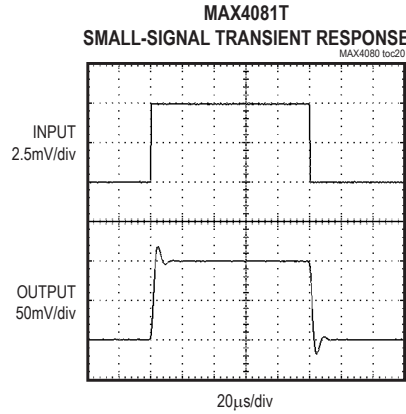
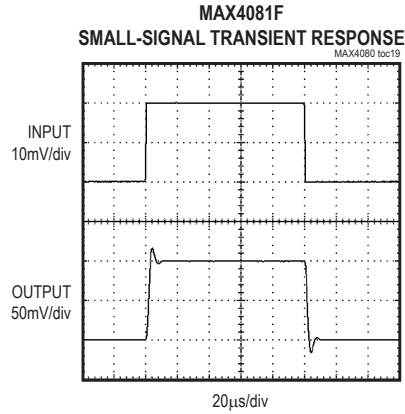

Typical Operating Characteristics (continued)

( $V_{CC} = V_{RS+} = 48V$ ,  $V_{SENSE} = 0V$ ,  $C_{LOAD} = 20pF$ ,  $R_{LOAD} = \infty$ ,  $T_A = +25^{\circ}C$ , unless otherwise noted.)

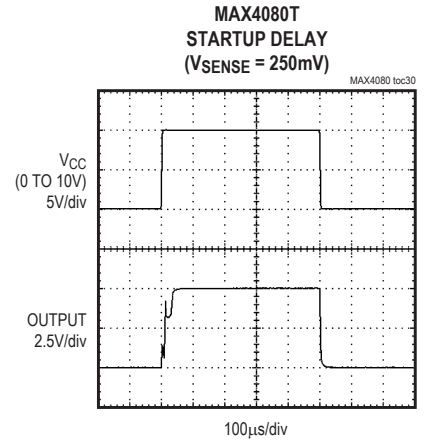
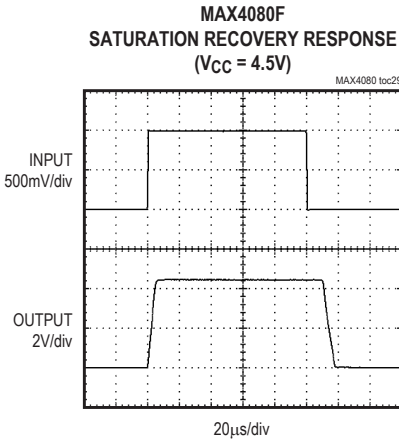
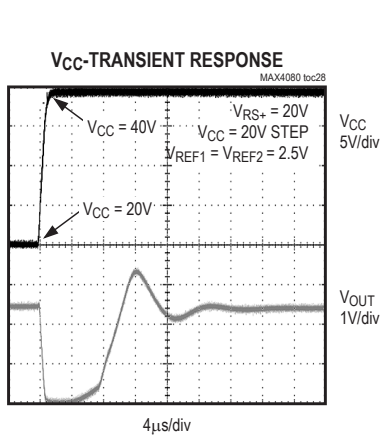

## Pin Description

PIN		NAME	FUNCTION
MAX4080	MAX4081		
1	1	RS+	Power connection to the external-sense resistor.
2	2	VCC	Supply Voltage Input. Decouple VCC to GND with at least a 0.1 $\mu$ F capacitor to bypass line transients.
3, 6, 7	3	N.C.	No Connection. No internal connection. Leave open or connect to ground.
4	4	GND	Ground
5	5	OUT	Voltage Output. For the unidirectional MAX4080, VOUT is proportional to VSENSE. For the bidirectional MAX4081, the difference voltage (VOUT - VREF) is proportional to VSENSE and indicates the correct polarity.
8	8	RS-	Load connection to the external sense resistor.
—	6	REF1B	Reference Voltage Input: Connect REF1B to REF1A or to GND (see the <i>External Reference</i> section).
—	7	REF1A	Reference Voltage Input: Connect REF1A and REF1B to a fixed reference voltage (VREF). VOUT is equal to VREF when VSENSE is zero (see the <i>External Reference</i> section).

## Detailed Description

The MAX4080/MAX4081 unidirectional and bidirectional high-side, current-sense amplifiers feature a 4.5V to 76V input common-mode range that is independent of supply voltage. This feature allows the monitoring of current out of a battery as low as 4.5V and also enables high-side current sensing at voltages greater than the supply voltage (VCC). The MAX4080/MAX4081 monitors current through a current-sense resistor and amplifies the voltage across the resistor. The MAX4080 senses current unidirectionally, while the MAX4081 senses current bidirectionally.

The 76V input voltage range of the MAX4080/MAX4081 applies independently to both supply voltage (VCC) and common-mode, input-sense voltage (VRS+). High-side current monitoring does not interfere with the ground path of the load being measured, making the MAX4080/MAX4081 particularly useful in a wide range of high-voltage systems.

Battery-powered systems require a precise bidirectional current-sense amplifier to accurately monitor the battery's charge and discharge. The MAX4081 charging current is represented by an output voltage from VREF to VCC, while discharge current is given from VREF to GND. Measurements of OUT with respect to VREF yield a positive and negative voltage during charge and discharge, as illustrated in Figure 1 for the MAX4081T.

## Current Monitoring

The MAX4080 operates as follows: current from the source flows through RSENSE to the load (Figure 2), creating a sense voltage, VSENSE. Since the internal-sense amplifier's inverting input has high impedance, negligible current flows through RG2 (neglecting the input bias current). Therefore, the sense amplifier's inverting input voltage equals VSOURCE - (ILOAD)(RSENSE). The amplifier's open-loop gain forces its noninverting input to the same voltage as the inverting input. Therefore, the drop across RG1 equals VSENSE. The internal current mirror multiplies IRG1 by a current gain factor,  $\beta$ , to give IA2 =  $\beta \times$  IRG1. Amplifier A2 is used to convert the output current to a voltage and then sent through amplifier A3. Total gain = 5V/V for MAX4080F, 20V/V for the MAX4080T, and 60V/V for the MAX4080S.

The MAX4081 input stage differs slightly from the MAX4080 (Figure 3). Its topology allows for monitoring of bidirectional currents through the sense resistor. When current flows from RS+ to RS-, the MAX4081 matches the voltage drop across the external sense resistor, RSENSE, by increasing the current through the Q1 and RG1. In this way, the voltages at the input terminals of the internal amplifier A1 are kept constant and an accurate measurement of the sense voltage is achieved. In the following amplifier stages of the MAX4081, the output signal of amplifier A2 is level-shifted to the reference voltage (VREF = VREF1A = VREF1B), resulting in a voltage at the output pin (OUT)



Figure 1. MAX4081T OUT Transfer Curve



Figure 2. MAX4080 Functional Diagram



Figure 3. MAX4081 Functional Diagram

that swings above  $V_{REF}$  voltage for positive-sense voltages and below  $V_{REF}$  for negative-sense voltages.  $V_{OUT}$  is equal to  $V_{REF}$  when  $V_{SENSE}$  is equal to zero. Set the full-scale output range by selecting  $R_{SENSE}$  and the appropriate gain version of the MAX4080/ MAX4081.

**Note:** For Gain = 5 (F),  $R_{G1} = R_{G2} = 160k$ .  
 For Gain = 20 (T),  $R_{G1} = R_{G2} = 60k$ .  
 For Gain = 60 (S),  $R_{G1} = R_{G2} = 20k$ .

**Table 1. Typical Component Values**

FULL-SCALE LOAD CURRENT, ILOAD (A)	CURRENT-SENSE RESISTOR (mΩ)	GAIN (V/V)	FULL-SCALE VSENSE (mV)	MAX4081 FULL-SCALE OUTPUT VOLTAGE (VOUT - VREF, V)
0.500	1000	5	±500	±2.5
0.125	1000	20	±125	±2.5
0.050	1000	60	±50	±3.0
5.000	100	5	±500	±2.5
1.250	100	20	±125	±2.5
0.500	100	60	±50	±3.0
50.000	10	5	±500	±2.5
12.500	10	20	±125	±2.5
5.000	10	60	±50	±3.0
FULL-SCALE LOAD CURRENT, ILOAD (A)	CURRENT-SENSE RESISTOR (mΩ)	GAIN (V/V)	FULL-SCALE VSENSE (mV)	MAX4080 FULL-SCALE OUTPUT VOLTAGE (V)
1.000	1000	5	1000	5.0
0.250	1000	20	250	5.0
0.100	1000	60	100	6.0
10.000	100	5	1000	5.0
2.500	100	20	250	5.0
1.000	100	60	100	6.0
50.000	10	5	500	2.5
25.000	10	20	250	5.0
10.000	10	60	100	6.0

**External References (MAX4081)**

For the bidirectional MAX4081, the  $V_{OUT}$  reference level is controlled by REF1A and REF1B.  $V_{REF}$  is defined as the average voltage of  $V_{REF1A}$  and  $V_{REF1B}$ . Connect REF1A and REF1B to a low-noise, regulated voltage source to set the output reference level. In this mode,  $V_{OUT}$  equals  $V_{REF1A}$  when  $V_{SENSE}$  equals zero (see Figure 4).

Alternatively, connect REF1B to ground, and REF1A to a low-noise, regulated voltage source. In this case, the output reference level ( $V_{REF}$ ) is equal to  $V_{REF1A}$  divided by two.  $V_{OUT}$  equals  $V_{REF1A}/2$  when  $V_{SENSE}$  equals zero.

In either mode, the output swings above the reference voltage for positive current-sensing ( $V_{RS+} > V_{RS-}$ ). The output swings below the reference voltage for negative current-sensing ( $V_{RS+} < V_{RS-}$ ).

**Applications Information****Recommended Component Values**

Ideally, the maximum load current develops the full-scale sense voltage across the current-sense resistor. Choose the gain needed to yield the maximum output voltage required for the application:

$$V_{OUT} = V_{SENSE} 5 A_V$$

where  $V_{SENSE}$  is the full-scale sense voltage, 1000mV for gain of 5V/V, 250mV for gain of 20V/V, 100mV for gain of 60V/V, and  $A_V$  is the gain of the device.

In applications monitoring a high current, ensure that  $R_{SENSE}$  is able to dissipate its own  $I^2R$  loss. If the resistor's power dissipation is exceeded, its value may drift or it may fail altogether.

The MAX4080/MAX4081 sense a wide variety of currents with different sense-resistor values. Table 1 lists common resistor values for typical operation.

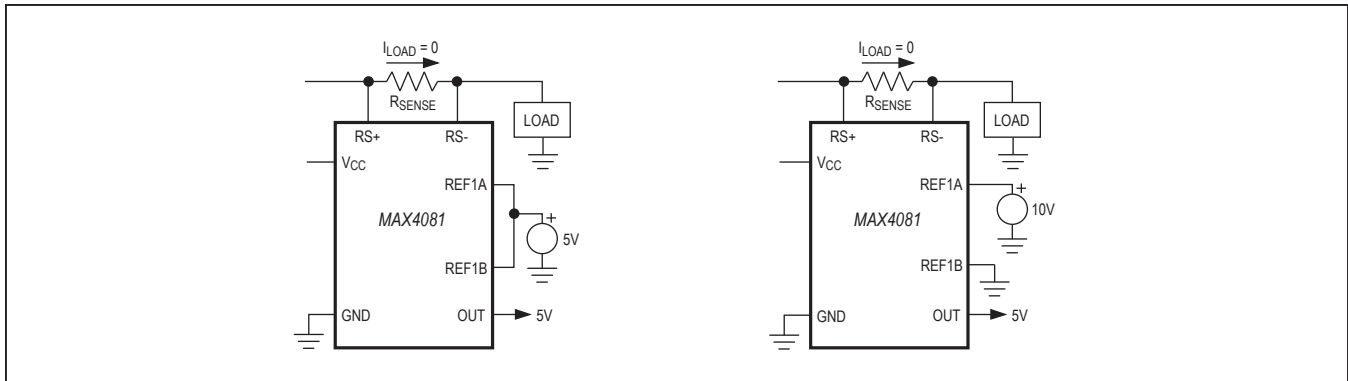

Figure 4. MAX4081 Reference Inputs

The full-scale output voltage is  $V_{OUT} = R_{SENSE} \times I_{LOAD(MAX)} \times A_V$ , for the MAX4080 and  $V_{OUT} = V_{REF} \pm R_{SENSE} \times I_{LOAD(MAX)} \times A_V$  for the MAX4081.  $V_{SENSE(MAX)}$  is 100mV for the 5V/V gain version, 250mV for the 20V/V gain version, and 100mV for the 60V/V gain version.

### Choosing the Sense Resistor

Choose  $R_{SENSE}$  based on the following criteria:

**Voltage Loss:** A high  $R_{SENSE}$  value causes the power-source voltage to degrade through IR loss. For minimal voltage loss, use the lowest  $R_{SENSE}$  value.

- **Accuracy:** A high  $R_{SENSE}$  value allows lower currents to be measured more accurately. This is due to offsets becoming less significant when the sense voltage is larger. For best performance, select  $R_{SENSE}$  to provide approximately 1000mV (gain of 5V/V), 250mV (gain of 20V/V), or 100mV (gain of 60V/V) of sense voltage for the full-scale current in each application.
- **Efficiency and Power Dissipation:** At high current levels, the  $I^2R$  losses in  $R_{SENSE}$  can be significant. Take this into consideration when choosing the resistor value and its power dissipation (wattage) rating. Also, the sense resistor's value might drift if it is allowed to heat up excessively.
- **Inductance:** Keep inductance low if  $I_{SENSE}$  has a large high-frequency component. Wire-wound resistors have the highest inductance, while metal film is somewhat better. Low-inductance, metal-film resistors are also available. Instead of being spiral-wrapped around a core, as in metal-film or wire-wound resistors, they are a straight band of metal and are available in values under  $1\Omega$ .

Because of the high currents that flow through  $R_{SENSE}$ , take care to eliminate parasitic trace resistance from causing errors in the sense voltage. Either use a four-terminal current-sense resistor or use Kelvin (force and sense) PC board layout techniques.

### Dynamic Range Consideration

Although the MAX4081 have fully symmetrical bidirectional  $V_{SENSE}$  input capability, the output voltage range is usually higher from REF to  $V_{CC}$  and lower from REF to GND (unless the supply voltage is at the lowest end of the operating range). Therefore, the user must consider the dynamic range of current monitored in both directions and choose the supply voltage and the reference voltage (REF) to make sure the output swing above and below REF is adequate to handle the swings without clipping or running out of headroom.

### Power-Supply Bypassing and Grounding

For most applications, bypass  $V_{CC}$  to GND with a  $0.1\mu\text{F}$  ceramic capacitor. In many applications,  $V_{CC}$  can be connected to one of the current monitor terminals (RS+ or RS-). Because  $V_{CC}$  is independent of the monitored voltage,  $V_{CC}$  can be connected to a separate regulated supply.

If  $V_{CC}$  will be subject to fast-line transients, a series resistor can be added to the power-supply line of the MAX4080/MAX4081 to minimize output disturbance. This resistance and the decoupling capacitor reduce the rise time of the transient. For most applications,  $1\text{k}\Omega$  in conjunction with a  $0.1\mu\text{F}$  bypass capacitor work well.

The MAX4080/MAX4081 require no special considerations with respect to layout or grounding. Consideration should be given to minimizing errors due to the large charge and discharge currents in the system.

**Power Management**

The bidirectional capability of the MAX4081 makes it an excellent candidate for use in smart battery packs. In the application diagram (Figure 5), the MAX4081 monitors the charging current into the battery as well as the discharge current out of the battery. The microcontroller stores this information, allowing the system to query the battery's status as needed to make system power-management decisions.



Figure 5. MAX4081 Used In Smart-Battery Application

**Selector Guide**

PART	GAIN (V/V)	ISENSE
MAX4080FAUA	5	Unidirectional
MAX4080FASA	5	Unidirectional
MAX4080TAUA	20	Unidirectional
MAX4080TASA	20	Unidirectional
MAX4080SAUA	60	Unidirectional
MAX4080SASA	60	Unidirectional
MAX4081FAUA	5	Bidirectional
MAX4081FASA	5	Bidirectional
MAX4081TAUA	20	Bidirectional
MAX4081TASA	20	Bidirectional
MAX4081SAUA	60	Bidirectional
MAX4081SASA	60	Bidirectional

**Typical Operating Circuit**



**Chip Information**

PROCESS: Bipolar

**Ordering Information (continued)**

PART	TEMP RANGE	PIN-PACKAGE
MAX4080TASA+	-40°C to +125°C	8 SO
MAX4080SAUA+	-40°C to +125°C	8 µMAX
MAX4080SAUA/V+	-40°C to +125°C	8 µMAX
MAX4080SASA+	-40°C to +125°C	8 SO
MAX4081FAUA+	-40°C to +125°C	8 µMAX
MAX4081FASA+	-40°C to +125°C	8 SO
MAX4081TAUA+	-40°C to +125°C	8 µMAX
MAX4081TASA+	-40°C to +125°C	8 SO
MAX4081SAUA+	-40°C to +125°C	8 µMAX
MAX4081SASA+	-40°C to +125°C	8 SO

+Denotes a lead(Pb)-free/RoHS-compliant package.

**Package Information**

For the latest package outline information and land patterns (footprints), go to [www.maximintegrated.com/packages](http://www.maximintegrated.com/packages). Note that a "+", "#", or "-" in the package code indicates RoHS status only. Package drawings may show a different suffix character, but the drawing pertains to the package regardless of RoHS status.

PACKAGE TYPE	PACKAGE CODE	OUTLINE NO.	LAND PATTERN NO.
8 µMAX	U8+1	<a href="#">21-0036</a>	<a href="#">90-0092</a>
8 SO	S8+2	<a href="#">21-0041</a>	<a href="#">90-0096</a>

## Revision History

REVISION NUMBER	REVISION DATE	DESCRIPTION	PAGES CHANGED
0	10/02	Initial release	—
1	11/08	Added values for RG1 and RG2	10
2	5/09	Added lead-free and automotive parts to <i>Ordering Information</i>	1
3	5/10	Removed automotive part and added soldering temperature	1, 2
4	7/11	Added automotive part designation	1
5	5/15	Updated <i>Benefits and Features</i> section	1
6	12/20	Updated <i>Package Information</i> section	13

For pricing, delivery, and ordering information, please visit Maxim Integrated's online storefront at <https://www.maximintegrated.com/en/storefront/storefront.html>.

Maxim Integrated cannot assume responsibility for use of any circuitry other than circuitry entirely embodied in a Maxim Integrated product. No circuit patent licenses are implied. Maxim Integrated reserves the right to change the circuitry and specifications without notice at any time. The parametric values (min and max limits) shown in the Electrical Characteristics table are guaranteed. Other parametric values quoted in this data sheet are provided for guidance.

## Looking for pricing, stock, or lifecycle information?

Click below to explore more details on WIN SOURCE:

- ⊖ [View MAX4080TAUA+ on WIN SOURCE](#)
- ⊖ [Maxim Integrated Information](#)

## Optimize Your Supply Chain with WIN SOURCE Solutions

- ✓ Global Sourcing Solution
- ✓ Obsolete Management
- ✓ Cost Control Management
- ✓ Shortage Management
- ✓ Alternative Solution
- ✓ Excess Inventory Management