



**THE DATASHEET OF
MAX3241EAI+**



Click [here](#) for production status of specific part numbers.

MAX3222/MAX3232/ MAX3237/MAX3241*

3.0V to 5.5V, Low-Power, Up to 1Mbps, True RS-232 Transceivers

General Description

The MAX3222/MAX3232/MAX3237/MAX3241 transceivers have a proprietary low-dropout transmitter output stage enabling true RS-232 performance from a 3.0V to 5.5V supply with a dual charge pump. The devices require only four small 0.1 μ F external charge-pump capacitors. The MAX3222, MAX3232, and MAX3241 are guaranteed to run at data rates of 120kbps while maintaining RS-232 output levels. The MAX3237 is guaranteed to run at data rates of 250kbps in normal operating mode and 1Mbps in the MegaBaud™ operating mode.

The MAX3222/MAX3232 have 2 receivers and 2 drivers. The MAX3222 and MAX3232 are pin, package, and functionally compatible with the industry-standard MAX242 and MAX232, respectively.

The MAX3241 has 5 receivers and 3 drivers, while the MAX3237 has 3 receivers and 5 drivers. Receivers R1 (MAX3237/MAX3241) and R2 (MAX3241) have extra outputs in addition to their standard outputs. These extra outputs are always active, allowing external devices to be monitored without forward biasing the protection diodes in circuitry that may have V_{CC} completely removed.

The MAX3222, MAX3232, and MAX3241 are available in space-saving TSSOP and SSOP packages with operating temperatures of either -40°C to +85°C or 0°C to 70°C.

Applications

- Battery-Powered Equipment
- Hand-Held Equipment
- Peripherals
- Datacom Equipment

Ordering Information continued at end of data sheet.

Typical Operating Circuits appear at end of data sheet.

MegaBaud and UCSP are trademarks of Maxim Integrated Products, Inc.

*Covered by U.S. Patent numbers 4,636,930; 4,679,134; 4,777,577; 4,797,899; 4,809,152; 4,897,774; 4,999,761; and other patents pending.

Benefits and Features

- Integrated Features Saves Board Space and Simplifies Design
 - Charge Pump Circuitry Eliminates the Need for a Bipolar \pm 12V Supply
 - Wide Single-Supply Operation From +3V to +5.5V Supply
 - Always-On Extra Outputs Enable Monitoring of External Devices
- Power Saving Extends Battery Life
 - 1 μ A Supply Current in Shutdown Mode While Receiver is Active (MAX3222, MAX3237, MAX3241)

Ordering Information

PART	TEMP RANGE	PIN-PACKAGE	PKG CODE
MAX3222CUP+	0°C to +70°C	20 TSSOP	U20+2
MAX3222CAP+	0°C to +70°C	20 SSOP	A20+1
MAX3222CWN+	0°C to +70°C	18 SO	W18+1
MAX3222CPN+	0°C to +70°C	18 Plastic Dip	P18+5

+Denotes lead-free package.

Pin Configurations

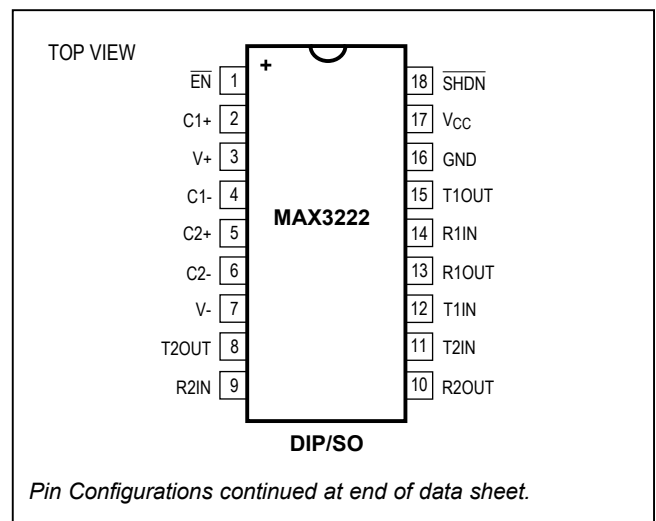

Absolute Maximum Ratings

V _{CC}	-0.3V to +6V
V+ (Note 1).....	-0.3V to +7V
V- (Note 1).....	+0.3V to -7V
V+ + V- (Note 1).....	+13V
Input Voltages	
T_IN, SHDN, EN.....	-0.3V to +6V
MBAUD.....	-0.3V to (V _{CC} + 0.3V)
R_IN.....	±25V
Output Voltages	
T_OUT.....	±13.2V
R_OUT.....	-0.3V to (V _{CC} + 0.3V)
Short-Circuit Duration	
T_OUT.....	Continuous

Continuous Power Dissipation (T _A = +70°C)		
16-Pin TSSOP (derate 6.7mW/°C above +70°C).....	533mW	
16-Pin Narrow SO (derate 8.70mW/°C above +70°C)....	696mW	
16-Pin Wide SO (derate 9.52mW/°C above +70°C) ...	762mW	
16-Pin Plastic DIP (derate 10.53mW/°C above +70°C)..	842mW	
18-Pin SO (derate 9.52mW/°C above +70°C).....	762mW	
18-Pin Plastic DIP (derate 11.11mW/°C above +70°C)...	889mW	
20-Pin SSOP (derate 7.00mW/°C above +70°C).....	559mW	
20-Pin TSSOP (derate 8.0mW/°C above +70°C).....	640mW	
28-Pin TSSOP (derate 8.7mW/°C above +70°C).....	696mW	
28-Pin SSOP (derate 9.52mW/°C above +70°C).....	762mW	
28-Pin SO (derate 12.50mW/°C above +70°C).....	1W	
Operating Temperature Ranges		
MAX32_C.....	0°C to +70°C	
MAX32_E.....	-40°C to +85°C	
Storage Temperature Range.....		-65°C to +150°C
Lead Temperature (soldering, 10s).....		+300°C

Note 1: V+ and V- can have a maximum magnitude of 7V, but their absolute difference cannot exceed 13V.

Stresses beyond those listed under "Absolute Maximum Ratings" may cause permanent damage to the device. These are stress ratings only, and functional operation of the device at these or any other conditions beyond those indicated in the operational sections of the specifications is not implied. Exposure to absolute maximum rating conditions for extended periods may affect device reliability.

Electrical Characteristics

(V_{CC} = +3.0V to +5.5V, C1–C4 = 0.1µF (Note 2), T_A = T_{MIN} to T_{MAX}, unless otherwise noted. Typical values are at T_A = +25°C.)

PARAMETER	CONDITIONS	MIN	TYP	MAX	UNITS	
DC CHARACTERISTICS						
V _{CC} Power-Supply Current	No load, V _{CC} = 3.3V or 5.0V, T _A = +25°C	MAX3222/MAX3232/ MAX3241		0.3	1.0	mA
		MAX3237		0.5	2.0	
Shutdown Supply Current	SHDN = GND, T _A = +25°C		1.0	10	µA	
LOGIC INPUTS AND RECEIVER OUTPUTS						
Input Logic Threshold Low (Note 3)	T_IN, EN, SHDN, MBAUD			0.8	V	
Input Logic Threshold High (Note 3)	V _{CC} = 3.3V	2.0			V	
	V _{CC} = 5.0V	2.4				
Input Leakage Current	T_IN, EN, SHDN, MBAUD		±0.01	±1.0	µA	
Output Leakage Current	Receivers disabled		±0.05	±10	µA	
Output Voltage Low	I _{OUT} = 1.6mA			0.4	V	
Output Voltage High	I _{OUT} = -1.0mA	V _{CC} - 0.6	V _{CC} - 0.1		V	
RECEIVER INPUTS						
Input Voltage Range		-25		25	V	
Input Threshold Low	T _A = +25°C	V _{CC} = 3.3V	0.6	1.2	V	
		V _{CC} = 5.0V	0.8	1.5		
Input Threshold High	T _A = +25°C	V _{CC} = 3.3V		1.5	2.4	V
		V _{CC} = 5.0V		1.8	2.4	

Electrical Characteristics (continued)

($V_{CC} = +3.0V$ to $+5.5V$, $C1-C4 = 0.1\mu F$ (Note 2), $T_A = T_{MIN}$ to T_{MAX} , unless otherwise noted. Typical values are at $T_A = +25^\circ C$.)

PARAMETER	CONDITIONS	MIN	TYP	MAX	UNITS
Input Hysteresis			0.3		V
Input Resistance	$T_A = +25^\circ C$	3	5	7	k Ω
TRANSMITTER OUTPUTS					
Output Voltage Swing	All transmitter outputs loaded with 3k Ω to ground	± 5.0	± 5.4		V
Output Resistance	$V_{CC} = V+ = V- = 0V$, $V_{OUT} = \pm 2V$	300	10M		Ω
Output Short-Circuit Current			± 35	± 60	mA
Output Leakage Current	$V_{OUT} = \pm 12V$, $V_{CC} = 0V$ or 3V to 5.5V, transmitters disabled			± 25	μA
MOUSE DRIVEABILITY (MAX3241)					
Transmitter Output Voltage	$T1IN = T2IN = GND$, $T3IN = V_{CC}$, $T3OUT$ loaded with 3k Ω to GND, $T1OUT$ and $T2OUT$ loaded with 2.5mA each	± 5.0			V

Timing Characteristics—MAX3222/MAX3232/MAX3241

($V_{CC} = +3.0V$ to $+5.5V$, $C1-C4 = 0.1\mu F$ (Note 2), $T_A = T_{MIN}$ to T_{MAX} , unless otherwise noted. Typical values are at $T_A = +25^\circ C$.)

PARAMETER	CONDITIONS	MIN	TYP	MAX	UNITS
Maximum Data Rate	$R_L = 3k\Omega$, $C_L = 1000pF$, one transmitter switching	120	235		kbps
Receiver Propagation Delay	R_{IN} to R_{OUT} , $C_L = 150pF$	t_{PHL}	0.3		μs
		t_{PLH}	0.3		
Receiver Output Enable Time	Normal operation		200		ns
Receiver Output Disable Time	Normal operation		200		ns
Transmitter Skew	$ t_{PHL} - t_{PLH} $		300		ns
Receiver Skew	$ t_{PHL} - t_{PLH} $		300		ns
Transition-Region Slew Rate	$V_{CC} = 3.3V$, $R_L = 3k\Omega$ to 7k Ω , $+3V$ to $-3V$ or $-3V$ to $+3V$, $T_A = +25^\circ C$, one transmitter switching	$C_L = 150pF$ to 1000pF	6	30	V/ μs
		$C_L = 150pF$ to 2500pF	4	30	

Timing Characteristics—MAX3237

($V_{CC} = +3.0V$ to $+5.5V$, C_1 – $C_4 = 0.1\mu F$ (Note 2), $T_A = T_{MIN}$ to T_{MAX} , unless otherwise noted. Typical values are at $T_A = +25^\circ C$.)

PARAMETER	CONDITIONS		MIN	TYP	MAX	UNITS
Maximum Data Rate	$R_L = 3k\Omega$, $C_L = 1000pF$, one transmitter switching, MBAUD = GND		250			kbps
	$V_{CC} = 3.0V$ to $4.5V$, $R_L = 3k\Omega$, $C_L = 250pF$, one transmitter switching, MBAUD = V_{CC}		1000			
	$V_{CC} = 4.5V$ to $5.5V$, $R_L = 3k\Omega$, $C_L = 1000pF$, one transmitter switching, MBAUD = V_{CC}		1000			
Receiver Propagation Delay	R_{IN} to R_{OUT} , $C_L = 150pF$	t_{PHL}	0.15			μs
		t_{PLH}	0.15			
Receiver Output Enable Time	Normal operation		200			ns
Receiver Output Disable Time	Normal operation		200			ns
Transmitter Skew	$ t_{PHL} - t_{PLH} $, MBAUD = GND		100			ns
	$ t_{PHL} - t_{PLH} $, MBAUD = V_{CC}		25			ns
Receiver Skew	$ t_{PHL} - t_{PLH} $		50			ns
Transition-Region Slew Rate	$V_{CC} = 3.3V$, $R_L = 3\Omega$ to $7k\Omega$, $+3V$ to $-3V$ or $-3V$ to $+3V$, $T_A = +25^\circ C$	$C_L = 150pF$ to $1000pF$	MBAUD = GND	6	30	$V/\mu s$
			MBAUD = V_{CC}	24	150	
		$C_L = 150pF$ to $2500pF$, MBAUD = GND	4	30		

Note 2: MAX3222/MAX3232/MAX3241: C_1 – $C_4 = 0.1\mu F$ tested at $3.3V \pm 10\%$; $C_1 = 0.047\mu F$, C_2 – $C_4 = 0.33\mu F$ tested at $5.0V \pm 10\%$.
MAX3237: C_1 – $C_4 = 0.1\mu F$ tested at $3.3V \pm 5\%$; C_1 – $C_4 = 0.22\mu F$ tested at $3.3V \pm 10\%$; $C_1 = 0.047\mu F$, C_2 – $C_4 = 0.33\mu F$ tested at $5.0V \pm 10\%$.

Note 3: Transmitter input hysteresis is typically 250mV.

Typical Operating Characteristics

($V_{CC} = +3.3V$, 235kbps data rate, $0.1\mu F$ capacitors, all transmitters loaded with $3k\Omega$, $T_A = +25^\circ C$, unless otherwise noted.)



Typical Operating Characteristics (continued)

($V_{CC} = +3.3V$, 235kbps data rate, $0.1\mu F$ capacitors, all transmitters loaded with $3k\Omega$, $T_A = +25^\circ C$, unless otherwise noted.)

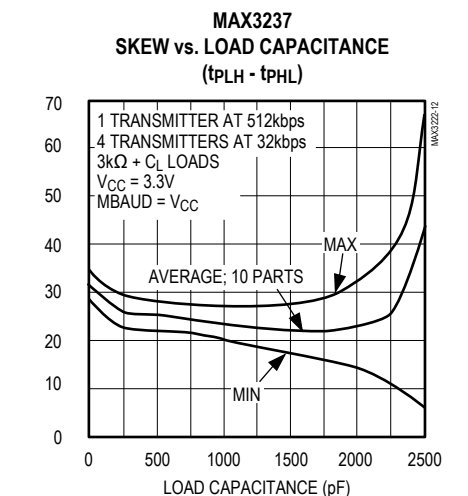
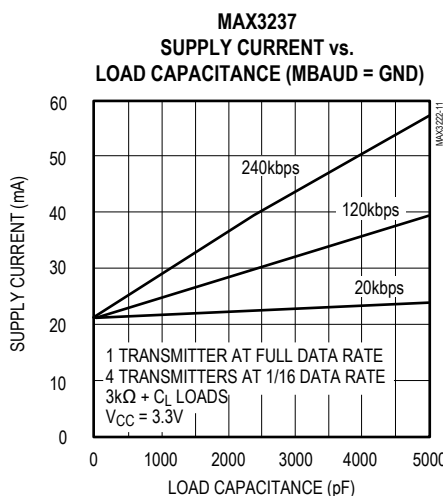
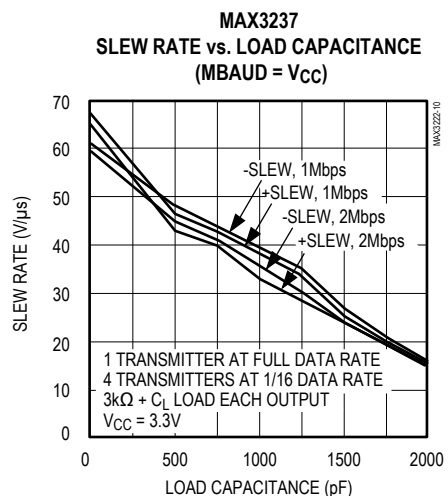
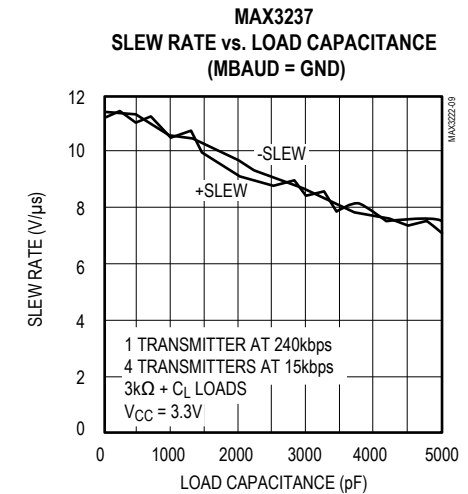
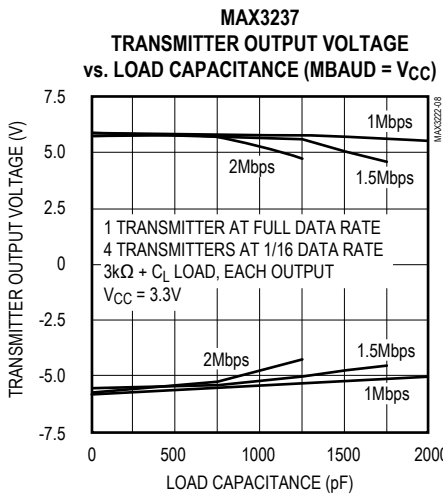
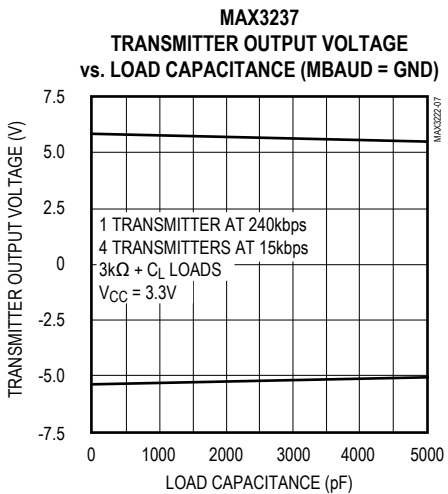
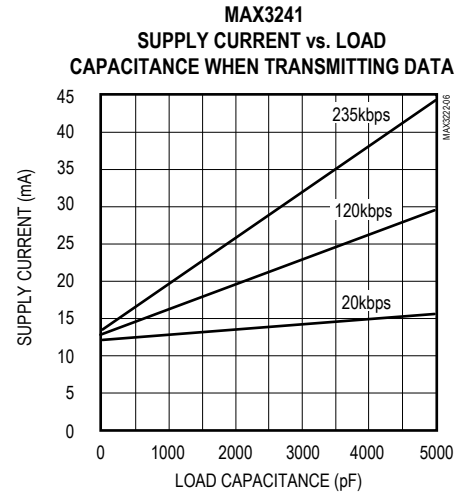
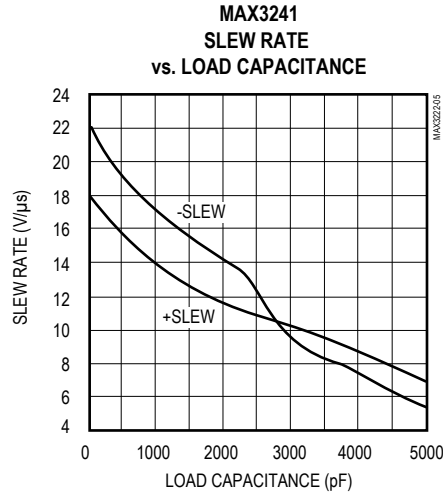
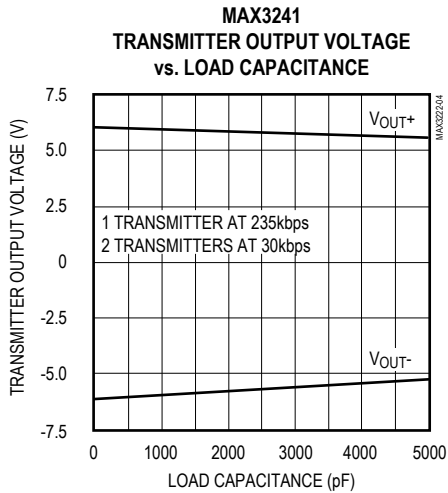

Pin Description

PIN					NAME	FUNCTION
MAX3222		MAX3232	MAX3237	MAX3241		
DIP/SO	SSOP					
1	1	—	13	23	\overline{EN}	Receiver Enable. Active low.
2	2	1	28	28	C1+	Positive Terminal of Voltage-Doubler Charge-Pump Capacitor
3	3	2	27	27	V+	+5.5V Generated by the Charge Pump
4	4	3	25	24	C1-	Negative Terminal of Voltage-Doubler Charge-Pump Capacitor
5	5	4	1	1	C2+	Positive Terminal of Inverting Charge-Pump Capacitor
6	6	5	3	2	C2-	Negative Terminal of Inverting Charge-Pump Capacitor
7	7	6	4	3	V-	-5.5V Generated by the Charge Pump
8, 15	8, 17	7, 14	5, 6, 7, 10, 12	9, 10, 11	T_OUT	RS-232 Transmitter Outputs
9, 14	9, 16	8, 13	8, 9, 11	4–8	R_IN	RS-232 Receiver Inputs
10, 13	10, 15	9, 12	18, 20, 21	15–19	R_OUT	TTL/CMOS Receiver Outputs
11, 12	12, 13	10, 11	17, 19, 22, 23, 24	12, 13, 14	T_IN	TTL/CMOS Transmitter Inputs
16	18	15	2	25	GND	Ground
17	19	16	26	26	V _{CC}	+3.0V to +5.5V Supply Voltage
18	20	—	14	22	\overline{SHDN}	Shutdown Control. Active low.
—	11, 14	—	—	—	N.C.	No Connection
—	—	—	15	—	MBAUD	MegaBaud Control Input. Connect to GND for normal operation; connect to V _{CC} for 1Mbps transmission rates.
—	—	—	16	20, 21	R_OUTB	Noninverting Complementary Receiver Outputs. Always active.

MAX3222/MAX3232/ MAX3237/MAX3241

3.0V to 5.5V, Low-Power, Up to 1Mbps, True RS-232 Transceivers

Detailed Description

Dual Charge-Pump Voltage Converter

The MAX3222/MAX3232/MAX3237/MAX3241's internal power supply consists of a regulated dual charge pump that provides output voltages of +5.5V (doubling charge pump) and -5.5V (inverting charge pump), regardless of the input voltage (V_{CC}) over the 3.0V to 5.5V range. The charge pumps operate in a discontinuous mode; if the output voltages are less than 5.5V, the charge pumps are enabled, and if the output voltages exceed 5.5V, the charge pumps are disabled. Each charge pump requires a flying capacitor (C1, C2) and a reservoir capacitor (C3, C4) to generate the V+ and V- supplies.

RS-232 Transmitters

The transmitters are inverting level translators that convert CMOS-logic levels to 5.0V EIA/TIA-232 levels.

The MAX3222/MAX3232/MAX3241 transmitters guarantee a 120kbps data rate with worst-case loads of 3k Ω in parallel with 1000pF, providing compatibility with PC-to-PC communication software (such as LapLink™). Typically, these three devices can operate at data rates of 235kbps. Transmitters can be paralleled to drive multiple receivers or mice.

LapLink is a trademark of Traveling Software, Inc.

The MAX3222/MAX3237/MAX3241's output stage is turned off (high impedance) when the device is in shut-down mode. When the power is off, the MAX3222/MAX3232/MAX3237/MAX3241 permit the outputs to be driven up to $\pm 12V$.

The transmitter inputs do not have pullup resistors. Connect unused inputs to GND or V_{CC} .

MAX3237 MegaBaud Operation

In normal operating mode (MBAUD = GND), the MAX3237 transmitters guarantee a 250kbps data rate with worst-case loads of 3k Ω in parallel with 1000pF. This provides compatibility with PC-to-PC communication software, such as LapLink.

For higher speed serial communications, the MAX3237 features MegaBaud operation. In MegaBaud operating mode (MBAUD = V_{CC}), the MAX3237 transmitters guarantee a 1Mbps data rate with worst-case loads of 3k Ω in parallel with 250pF for 3.0V < V_{CC} < 4.5V. For 5V $\pm 10\%$ operation, the MAX3237 transmitters guarantee a 1Mbps data rate into worst-case loads of 3k Ω in parallel with 1000pF.



Figure 1. Slew-Rate Test Circuits

MAX3222/MAX3232/
MAX3237/MAX3241

3.0V to 5.5V, Low-Power, Up to 1Mbps,
True RS-232 Transceivers



Figure 2. Detection of RS-232 Activity when the UART and Interface are Shut Down; Comparison of MAX3237/MAX3241 (b) with Previous Transceivers (a).

RS-232 Receivers

The receivers convert RS-232 signals to CMOS-logic output levels. The MAX3222/MAX3237/MAX3241 receivers have inverting three-state outputs. In shutdown, the receivers can be active or inactive (Table 1).

The complementary outputs on the MAX3237 (R1OUTB) and the MAX3241 (R1OUTB, R2OUTB) are always active, regardless of the state of \overline{EN} or \overline{SHDN} . This allows for Ring Indicator applications without forward biasing other devices connected to the receiver outputs. This is ideal for systems where V_{CC} is set to 0V in shutdown to accommodate peripherals, such as UARTs (Figure 2).

MAX3222/MAX3237/MAX3241 Shutdown Mode

Supply current falls to less than 1μA in shutdown mode (\overline{SHDN} = low). When shut down, the device's charge pumps are turned off, V₊ is pulled down to V_{CC}, V₋ is pulled to ground, and the transmitter outputs are disabled (high impedance). The time required to exit shutdown is typically 100μs, as shown in Figure 3. Connect \overline{SHDN} to V_{CC} if the shutdown mode is not used. \overline{SHDN} has no effect on R_{OUT} or R_{OUTB}.

MAX3222/MAX3237/MAX3241 Enable Control

The inverting receiver outputs (R_{OUT}) are put into a high-impedance state when \overline{EN} is high. The complementary outputs R1OUTB and R2OUTB are always active, regardless of the state of \overline{EN} and \overline{SHDN} (Table 1). \overline{EN} has no effect on T_{OUT}.

Applications Information

Capacitor Selection

The capacitor type used for C1–C4 is not critical for proper operation; polarized or nonpolarized capacitors can be used. The charge pump requires 0.1μF capacitors for 3.3V operation. For other supply voltages, refer to Table 2 for required capacitor values. Do not use values lower than those listed in Table 2. Increasing the capacitor values (e.g., by a factor of 2) reduces ripple on the transmitter outputs and slightly reduces power consumption. C2, C3, and C4 can be increased without changing C1's value. However, do not increase C1 without also increasing the values of C2, C3, and C4, to maintain the proper ratios (C1 to the other capacitors).

When using the minimum required capacitor values, make sure the capacitor value does not degrade excessively with temperature. If in doubt, use capacitors with a higher nominal value. The capacitor's equivalent series resistance (ESR), which usually rises at low temperatures, influences the amount of ripple on V₊ and V₋.

Table 1. MAX3222/MAX3237/MAX3241 Shutdown and Enable Control Truth Table

$\overline{\text{SHDN}}$	$\overline{\text{EN}}$	T_OUT	R_OUT	R_OUTB (MAX3237/ MAX3241)
0	0	High-Z	Active	Active
0	1	High-Z	High-Z	Active
1	0	Active	Active	Active
1	1	Active	High-Z	Active

Table 2. Required Minimum Capacitor Values

V _{CC} (V)	C1 (μF)	C2, C3, C4 (μF)
MAX3222/MAX3232/MAX3241		
3.0 to 3.6	0.1	0.1
4.5 to 5.5	0.047	0.33
3.0 to 5.5	0.1	0.47
MAX3237		
3.0 to 3.6	0.22	0.22
3.15 to 3.6	0.1	0.1
4.5 to 5.5	0.047	0.33
3.0 to 5.5	0.22	1.0



Figure 3. Transmitter Outputs when Exiting Shutdown or Powering Up

Power-Supply Decoupling

In most circumstances, a 0.1 μF bypass capacitor is adequate. In applications that are sensitive to power-supply noise, decouple V_{CC} to ground with a capacitor of the same value as charge-pump capacitor C1. Connect bypass capacitors as close to the IC as possible.

Operation Down to 2.7V

Transmitter outputs will meet EIA/TIA-562 levels of $\pm 3.7\text{V}$ with supply voltages as low as 2.7V.

Transmitter Outputs when Exiting Shutdown

Figure 3 shows two transmitter outputs when exiting shutdown mode. As they become active, the two transmitter outputs are shown going to opposite RS-232 levels (one transmitter input is high, the other is low). Each transmitter is loaded with 3k Ω in parallel with 2500pF. The transmitter outputs display no ringing or undesirable transients as they come out of shutdown. Note that the transmitters are enabled only when the magnitude of V₋ exceeds approximately 3V.

Mouse Driveability

The MAX3241 has been specifically designed to power serial mice while operating from low-voltage power supplies. It has been tested with leading mouse brands from manufacturers such as Microsoft and Logitech. The MAX3241 successfully drove all serial mice tested and met their respective current and voltage requirements. Figure 4a shows the transmitter output voltages under increasing load current at 3.0V. Figure 4b shows a typical mouse connection using the MAX3241.



Figure 4a. MAX3241 Transmitter Output Voltage vs. Load Current per Transmitter



Figure 4b. Mouse Driver Test Circuit

MAX3222/MAX3232/
MAX3237/MAX3241

3.0V to 5.5V, Low-Power, Up to 1Mbps,
True RS-232 Transceivers

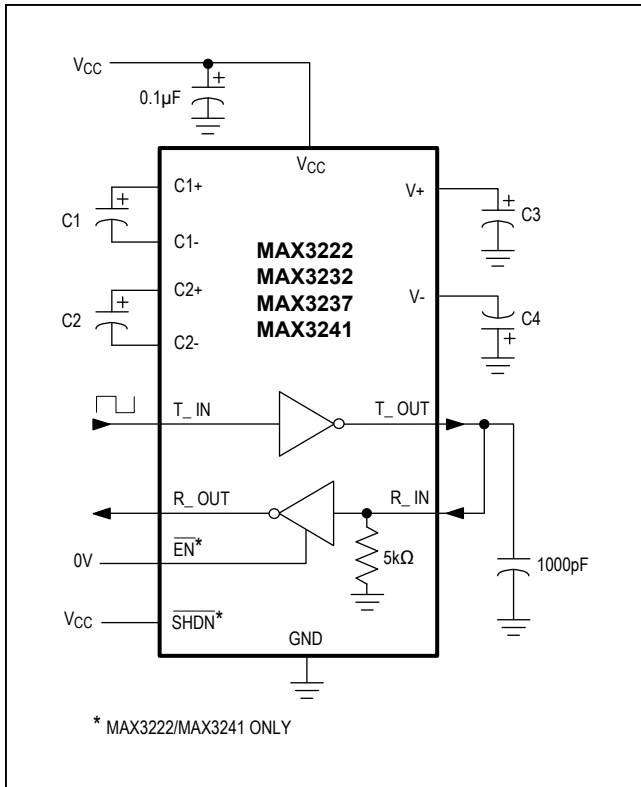

Figure 5. Loopback Test Circuit

High Data Rates

The MAX3222/MAX3232/MAX3241 maintain the RS-232 $\pm 5.0V$ minimum transmitter output voltage even at high data rates. Figure 5 shows a transmitter loopback test circuit. Figure 6 shows a loopback test result at 120kbps, and Figure 7 shows the same test at 235kbps. For Figure 6, all transmitters were driven simultaneously at 120kbps into RS-232 loads in parallel with 1000pF. For Figure 7, a single transmitter was driven at 235kbps, and all transmitters were loaded with an RS-232 receiver in parallel with 1000pF.

The MAX3237 maintains the RS-232 $\pm 5.0V$ minimum transmitter output voltage at data rates up to 1Mbps. Figure 8 shows a loopback test result at 1Mbps with $MBAUD = V_{CC}$. For Figure 8, all transmitters were loaded with an RS-232 receiver in parallel with 250pF.

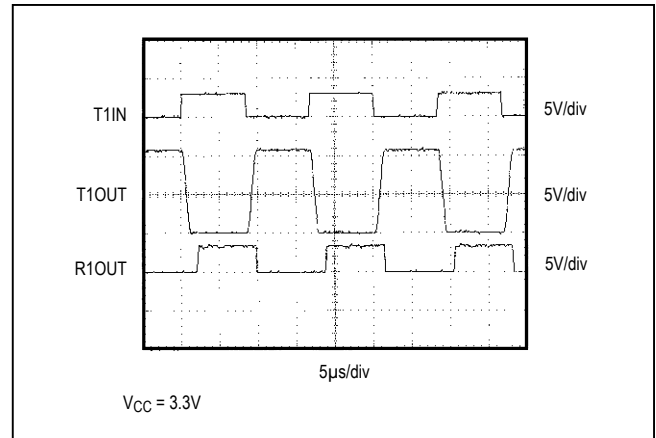

Figure 6. MAX3241 Loopback Test Result at 120kbps

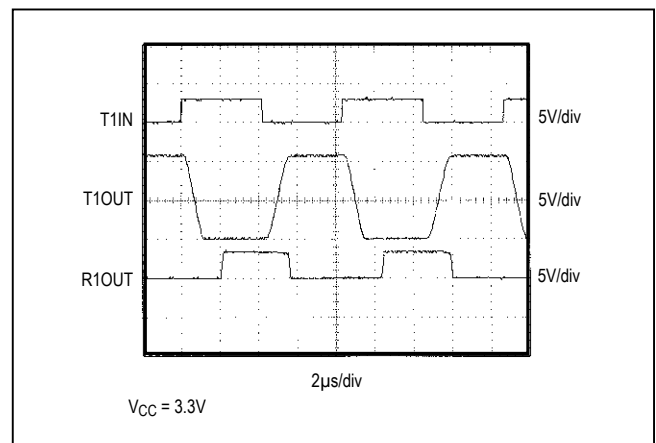

Figure 7. MAX3241 Loopback Test Result at 235kbps



Figure 8. MAX3237 Loopback Test Result at 1000kbps ($MBAUD = V_{CC}$)

MAX3222/MAX3232/ MAX3237/MAX3241

3.0V to 5.5V, Low-Power, Up to 1Mbps,
True RS-232 Transceivers

Interconnection with 3V and 5V Logic

The MAX3222/MAX3232/MAX3237/MAX3241 can directly interface with various 5V logic families, including ACT and HCT CMOS. See Table 3 for more information on possible combinations of interconnections.

Table 3. Logic-Family Compatibility with Various Supply Voltages

SYSTEM POWER-SUPPLY VOLTAGE (V)	MAX32__ V _{CC} SUPPLY VOLTAGE (V)	COMPATIBILITY
3.3	3.3	Compatible with all CMOS families.
5	5	Compatible with all TTL and CMOS-logic families
5	3.3	Compatible with ACT and HCT CMOS, and with TTL. Incompatible with AC, HC, and CD4000 CMOS.

Typical Operating Circuits



Typical Operating Circuits (continued)



Pin Configurations (continued)

TOP VIEW



MAX3222/MAX3232/
MAX3237/MAX3241

3.0V to 5.5V, Low-Power, Up to 1Mbps,
True RS-232 Transceivers

Ordering Information (continued)

PART	TEMP RANGE	PIN-PACKAGE	PKG CODE
MAX3222EUP+	-40°C to +85°C	20 TSSOP	U20+2
MAX3222EAP+	-40°C to +85°C	20 SSOP	A20+1
MAX3222EWN+	-40°C to +85°C	18 SO	W18+1
MAX3222EPN+	-40°C to +85°C	18 Plastic Dip	P18+5
MAX3222C/D	0°C to +70°C	Dice*	—
MAX3232CAE+	0°C to +70°C	16 SSOP	A16+2
MAX3232CUE+	0°C to +70°C	16 TSSOP	U16+1
MAX3232CSE+	0°C to +70°C	16 Narrow SO	S16+1
MAX3232CWE+	0°C to +70°C	16 Wide SO	W16+1
MAX3232CPE+	0°C to +70°C	16 Plastic DIP	P16+1
MAX3232EUE+	-40°C to +85°C	16 TSSOP	U16+1
MAX3232ESE+	-40°C to +85°C	16 Narrow SO	S16+5

PART	TEMP RANGE	PIN-PACKAGE	PKG CODE
MAX3232EWE+	-40°C to +85°C	16 Wide SO	W16+1
MAX3232EPE+	-40°C to +85°C	16 Plastic DIP	P16+1
MAX3237CAI+	0°C to +70°C	16 SSOP	A28+2
MAX3237EAI+	-40°C to +85°C	28 SSOP	A28+1
MAX3241CUI+	0°C to +70°C	28 TSSOP	U28+2
MAX3241CAI+	0°C to +70°C	28 SSOP	A28+1
MAX3241CWI+	0°C to +70°C	28 SO	W28+6
MAX3241EUI+	-40°C to +85°C	28 TSSOP	U28+2
MAX3241EAI+	-40°C to +85°C	28 SSOP	A28+1
MAX3241EWI+	-40°C to +85°C	28 SO	W28+6

*Dice are tested at $T_A = +25^\circ\text{C}$, DC parameters only.
+Denotes lead-free package.

3V-Powered EIA/TIA-232 and EIA/TIA-562 Transceivers from Maxim

PART	POWER-SUPPLY VOLTAGE (V)	NO. OF TRANSMITTERS/RECEIVERS	NO. OF RECEIVERS ACTIVE IN SHUTDOWN	GUARANTEED DATA RATE (kbps)	EIA/TIA-232 OR 562	FEATURES
MAX212	3.0 to 3.6	3/5	5	120	232	Drives mice
MAX218	1.8 to 4.25	2/2	2	120	232	Operates directly from batteries without a voltage regulator
MAX562	2.7 to 5.25	3/5	5	230	562	Wide supply range
MAX563	3.0 to 3.6	2/2	2	230	562	0.1µF capacitors
MAX3212	2.7 to 3.6	3/5	5	235	232	AutoShutdown, complementary receiver, drives mice, transient detection
MAX3222	3.0 to 5.5	2/2	2	120	232	0.1µF capacitors
MAX3223	3.0 to 5.5	2/2	2	120	232	0.1µF capacitors, AutoShutdown
MAX3232	3.0 to 5.5	2/2	N/A	120	232	0.1µF capacitors
MAX3237	3.0 to 5.5	5/3	3	250/1000	232	0.1µF capacitors, 1 complementary receiver, MegaBaud operation
MAX3241	3.0 to 5.5	3/5	5	120	232	0.1µF capacitors, 2 complementary receivers, drives mice
MAX3243	3.0 to 5.5	3/5	1	120	232	0.1µF capacitors, AutoShutdown, complementary receiver, drives mice

Package Information

For the latest package outline information and land patterns (footprints), go to www.maximintegrated.com/packages. Note that a "+", "#", or "-" in the package code indicates RoHS status only. Package drawings may show a different suffix character, but the drawing pertains to the package regardless of RoHS status.

PACKAGE TYPE	PACKAGE CODE	OUTLINE NO.	LAND PATTERN NO.	THERMAL RESISTANCE (SINGLE LAYER BOARD)		THERMAL RESISTANCE (MULTI LAYER BOARD)	
				θ_{JA} (°C/W)	θ_{JC} (°C/W)	θ_{JA} (°C/W)	θ_{JC} (°C/W)
20 TSSOP	U20+2	21-0066	90-0116	91	20	73.8	20
20 SSOP	A20+1	21-0056	90-0094	125	33	84	32
18 SO	W18+1	21-0042	90-0181	105	22	67	23
18 Plastic Dip	P18+5	21-0043	—	90	30	NA	NA
Dice*	—	—	—	—	—	—	—
16 TSSOP	U16+1	21-0066	90-0117	106	27	90	27
16 Narrow SO	S16+1	21-0041	90-0097	115	32	75	24
16 Wide SO	W16+1	21-0042	90-0107	105	22	71	23
16 Plastic DIP	P16+1	21-0043	—	95	35	NA	NA
16 Narrow SO	S16+5	21-0041	90-0097	115	32	73	23
16 SSOP	A16+2	21-0056	90-0106	140	34	86	33
16 SSOP	A28+2	21-0056	90-0095	105	24	67	25
28 SSOP	A28+1	21-0056	90-0095	110	25	67.1	25
28 TSSOP	U28+2	21-0066	90-0171	78	13	71.6	13
28 SO	W28+6	21-0042	90-0109	80	18	59	18
28 TSSOP	U28+2	21-0066	90-0171	78	13	71.6	13

Revision History



REVISION NUMBER	REVISION DATE	DESCRIPTION	PAGES CHANGED
7	1/07	General updates	1, 15, 16, 17
8	6/18	Updated <i>Package Information</i> and <i>Ordering Information</i>	1, 15, 16, 17
9	4/19	Added Thermal Resistance data in the <i>Package Information</i> table	16
10	5/19	Updated <i>Package Information</i> table	16

For pricing, delivery, and ordering information, please visit Maxim Integrated's online storefront at <https://www.maximintegrated.com/en/storefront/storefront.html>.

Maxim Integrated cannot assume responsibility for use of any circuitry other than circuitry entirely embodied in a Maxim Integrated product. No circuit patent licenses are implied. Maxim Integrated reserves the right to change the circuitry and specifications without notice at any time. The parametric values (min and max limits) shown in the Electrical Characteristics table are guaranteed. Other parametric values quoted in this data sheet are provided for guidance.

Looking for pricing, stock, or lifecycle information?

Click below to explore more details on WIN SOURCE:

-  [View MAX3241EAI+ on WIN SOURCE](#)
-  [Maxim Integrated Information](#)

Optimize Your Supply Chain with WIN SOURCE Solutions

-  Global Sourcing Solution
-  Obsolete Management
-  Cost Control Management
-  Shortage Management
-  Alternative Solution
-  Excess Inventory Management