

Spread-Spectrum Clock Generators

General Description

The MAX31C80/MAX31D80 are spread-spectrum clock generators that contain a phase-locked loop (PLL) that generates a 2MHz to 134MHz clock from an input clock or crystal. The PLL can provide a spread-spectrum down-dithered (MAX31D80) or center-dithered (MAX31C80) frequency-modulated clock. The devices also buffer the incoming clock and provide this output on a separate pin.

The MAX31C80/MAX31D80 are provided in a 10-pin TDFN package and operate over a full -40°C to $+125^{\circ}\text{C}$ automotive temperature range. Devices can be factory programmed for multiple combinations of input and output frequencies (see the *Ordering Information* table). A low-cost, low-frequency crystal can be used at the input to generate frequencies up to 134MHz.

Typical Application Circuit

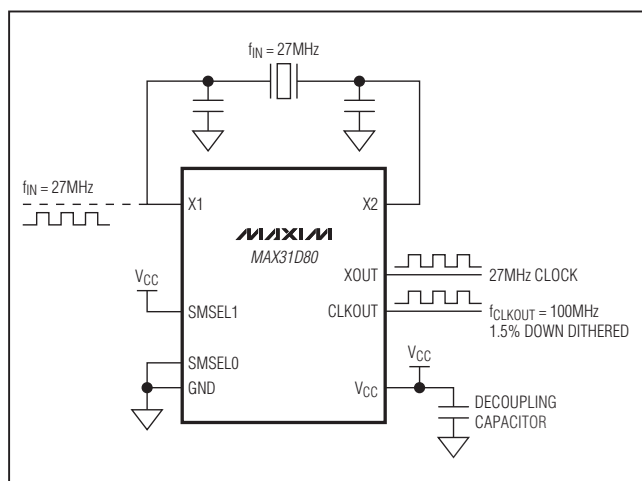

Features

- ◆ 2MHz to 134MHz Spread-Spectrum Clock Generator
- ◆ Input Can Be Either an 8MHz to 34MHz Crystal or 8MHz to 134MHz Clock
- ◆ Factory-Programmable Output Frequencies in 2MHz to 134MHz Range
- ◆ Low-Cost Crystal at Low Frequency Used to Generate High Frequencies
- ◆ On-Board PLL is Capable of Spread-Spectrum Frequency Modulation
- ◆ Down- or Center-Dither Spread-Spectrum Frequency Modulation
- ◆ User-Configurable Spread-Spectrum Dither Magnitude
- ◆ Low Cycle-to-Cycle Jitter
- ◆ 3.3V Supply Voltage
- ◆ Temperature Range: -40°C to $+125^{\circ}\text{C}$
- ◆ Small Package: 10-Pin TDFN (3mm x 3mm x 0.8mm)

Applications

Graphics Cards
Set-Top Boxes
Automotive Infotainment
Printers

Ordering Information

PART	TEMP RANGE	DITHER MODE	PIN-PACKAGE
MAX31C80T-xxx+	-40°C to $+125^{\circ}\text{C}$	Center	10 TDFN-EP*
MAX31C80T-xxx+T	-40°C to $+125^{\circ}\text{C}$	Center	10 TDFN-EP*
MAX31D80T-xxx+	-40°C to $+125^{\circ}\text{C}$	Down	10 TDFN-EP*
MAX31D80T-xxx+T	-40°C to $+125^{\circ}\text{C}$	Down	10 TDFN-EP*

xxx = Factory-programmable output frequency and dither rate (see the Selector Guide table).

+Denotes a lead(Pb)-free/RoHS-compliant package.

T = Tape and reel.

*EP = Exposed pad.

Selector Guide appears at end of data sheet.

Spread-Spectrum Clock Generators

ABSOLUTE MAXIMUM RATINGS

Voltage Range on VCC Relative to GND.....-0.3V to +4.3V
 Voltage Range on Any Other Pin
 Relative to GND-0.3V to (VCC + 0.3V)*
 Continuous Power Dissipation (TA = +70°C)
 10-Pin TDFN (derate 24.4mW/°C above +70°C)..... 1951.2mW

Storage Temperature Range.....-55°C to +135°C
 Lead Temperature (soldering, 10s)+300°C
 Soldering Temperature (reflow)+260°C

*Not to exceed +4.3V.

Stresses beyond those listed under "Absolute Maximum Ratings" may cause permanent damage to the device. These are stress ratings only, and functional operation of the device at these or any other conditions beyond those indicated in the operational sections of the specifications is not implied. Exposure to absolute maximum rating conditions for extended periods may affect device reliability.

RECOMMENDED OPERATING CONDITIONS

(TA = -40°C to +125°C.)

PARAMETER	SYMBOL	CONDITIONS	MIN	TYP	MAX	UNITS
Supply Voltage	VCC		3.0	3.3	3.6	V
Input Logic 0 (SMSEL0 and SMSEL1)	VIL		-0.3		0.25 x VCC	V
Input Logic 1 (SMSEL0 and SMSEL1)	VIH		0.75 x VCC		VCC + 0.3	V
Input Logic Unconnected (SMSEL0 and SMSEL1)	VIF	Limits are in case user wants to force voltage instead of unconnecting this pin	0.4 x VCC		0.55 x VCC	V
Input Logic 0 for X1	VIL:X1		-0.3		0.3 x VCC	V
Input Logic 1 for X1	VIH:X1		0.7 x VCC		VCC + 0.3	V
XOUT Load	CL:XOUT				15	pF
CLKOUT Load	CL:CLKOUT	2MHz ≤ fCLKOUT < 67MHz			15	pF
		67MHz ≤ fCLKOUT < 101MHz			10	
		101MHz ≤ fCLKOUT ≤ 134MHz			7	
Crystal Frequency	fIN		8		34	MHz
Clock Input Frequency	fIN		8		134	MHz
Crystal ESR	XESR				90	Ω
Clock Input Duty Cycle	fINDC		40		60	%
Crystal Parallel Load Capacitance	CCL				18	pF

Spread-Spectrum Clock Generators

DC ELECTRICAL CHARACTERISTICS

($3.0V \leq V_{CC} \leq 3.6V$, $T_A = -40^\circ\text{C}$ to $+125^\circ\text{C}$, unless otherwise noted.)

PARAMETER	SYMBOL	CONDITIONS	MIN	TYP	MAX	UNITS
Supply Current	I_{DD}	$f_{IN} = 27\text{MHz}$, $f_{CLKOUT} = 100\text{MHz}$, down dithered, $C_L = 10\text{pF}$		22		mA
Input Leakage (SMSEL0 and SMSEL1)	I_{IL}	$SMSEL_ = GND$ or V_{CC}			± 15	μA
Low-Level Output Voltage (XOUT and CLKOUT)	V_{OL}	$I_{OL} = 10\text{mA}$			0.2	V
High-Level Output Voltage (XOUT and CLKOUT)	V_{OH}	$I_{OH} = -10\text{mA}$	$V_{CC} - 0.2$			V
Input Capacitance (X1 and X2)	C_{IN}			5		pF

AC ELECTRICAL CHARACTERISTICS

($3.0V \leq V_{CC} \leq 3.6V$, $T_A = -40^\circ\text{C}$ to $+125^\circ\text{C}$, unless otherwise noted.)

PARAMETER	SYMBOL	CONDITIONS	MIN	TYP	MAX	UNITS
CLKOUT Duty Cycle	$f_{CLKOUT:DC}$	$C_L:CLKOUT = 7\text{pF}$	40		60	%
XOUT Duty Cycle	$f_{XOUT:DC}$	$C_L:XOUT = 7\text{pF}$, $T_A = +25^\circ\text{C}$, $V_{CC} = 3.3V$	40		60	
Rise Time	t_R	$C_L:CLKOUT = 7\text{pF}$		1.6		ns
Fall Time	t_F	$C_L:CLKOUT = 7\text{pF}$		1.6		ns
Dither Rate Range	f_{DR}	Factory programmable	20		40	kHz
Dither Rate Accuracy			-4		+4	%
Peak Cycle-to-Cycle Jitter	t_J	$CLKOUT = 100\text{MHz}$, 10,000 cycles, $T_A = +25^\circ\text{C}$		75		ps
Power-Up Time	t_{PUP}	V_{CC} valid to output active, $T_A = +25^\circ\text{C}$, $V_{CC} = 3.3V$		1		ms

Spread-Spectrum Clock Generators

Typical Operating Characteristics

($V_{CC} = +3.3V$, $T_A = +25^\circ C$, unless otherwise noted.)

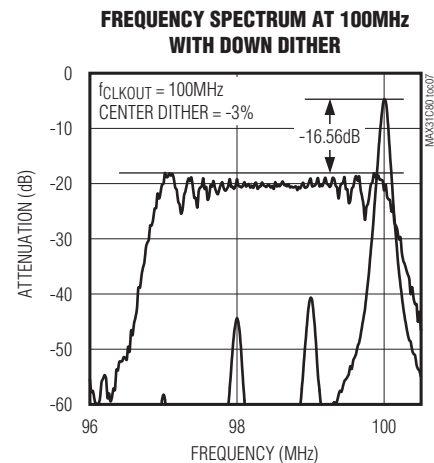
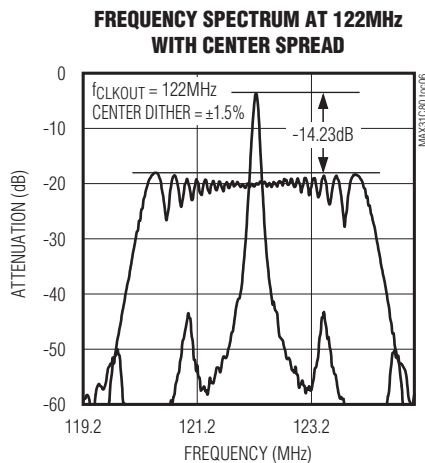
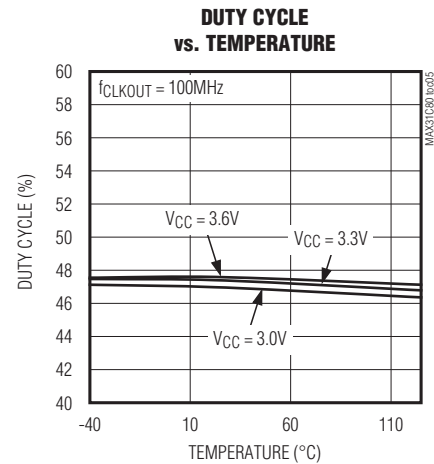
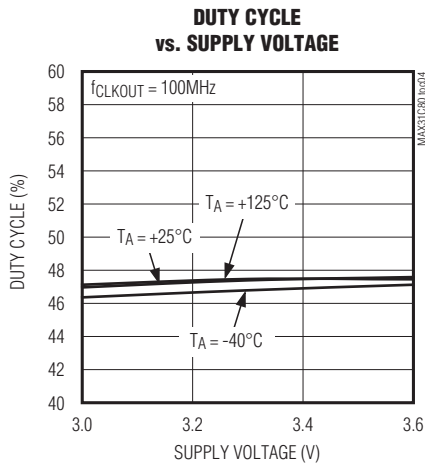
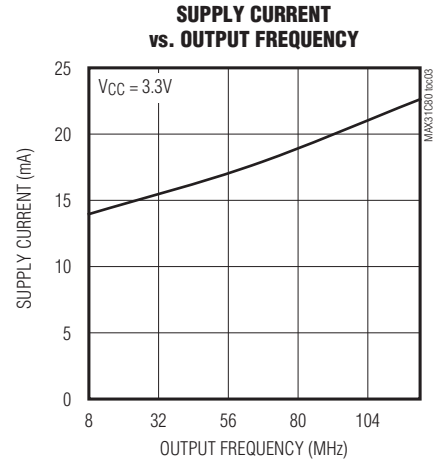
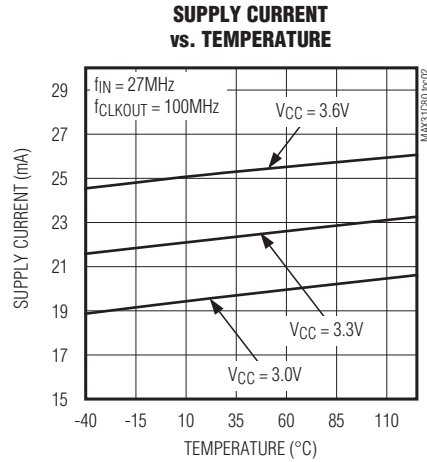
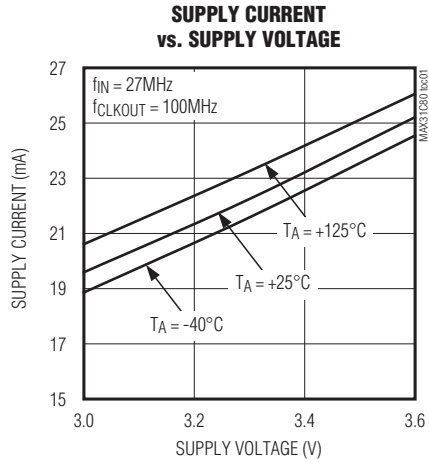

Spread-Spectrum Clock Generators

Block Diagram

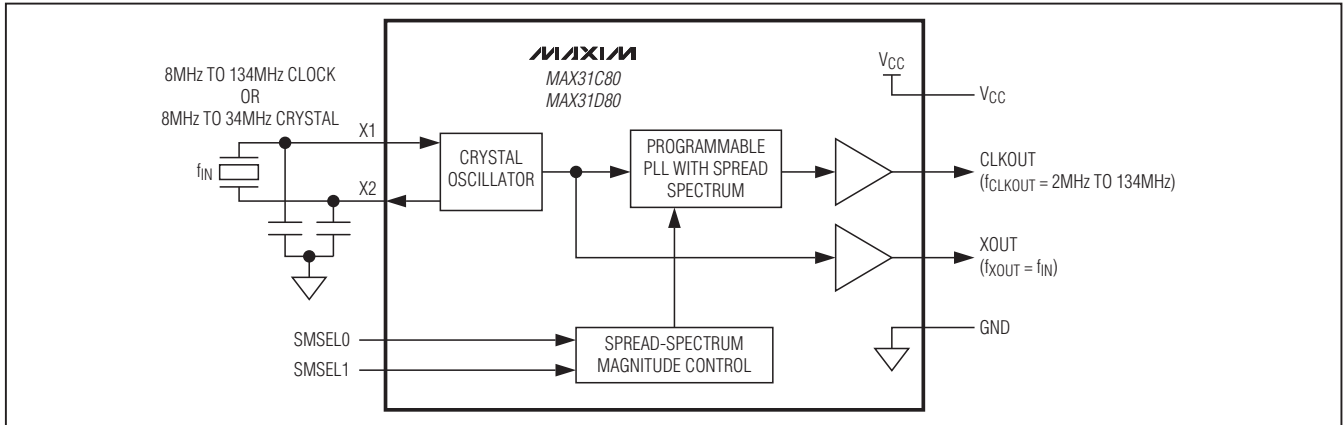

Pin Configuration

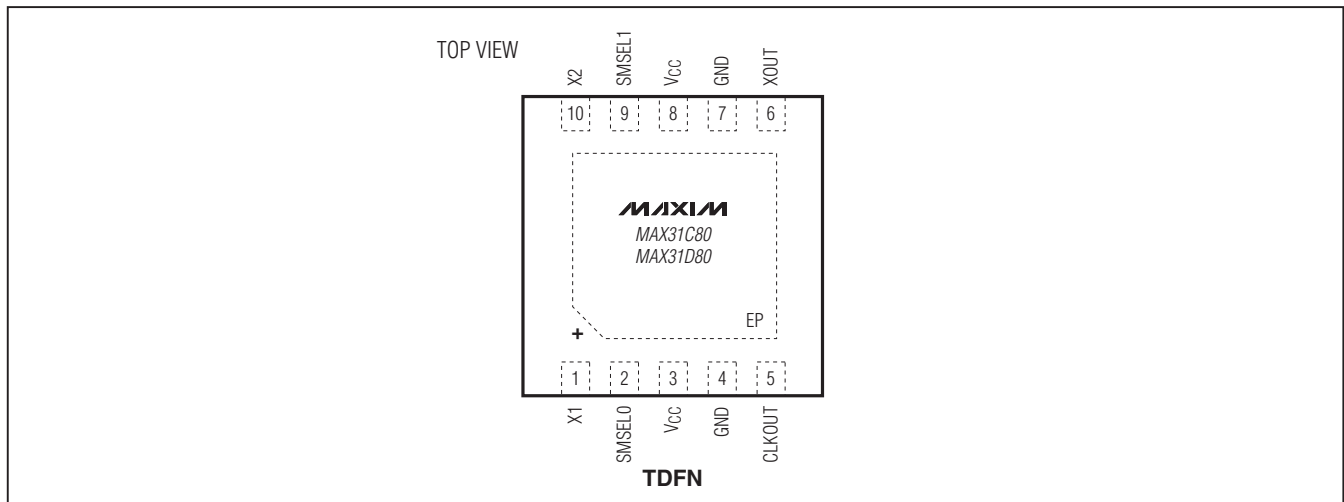

Pin Description

PIN	NAME	FUNCTION
1	X1	Crystal Drive/Clock Input. A crystal with the proper loading is connected across X1 and X2. Instead of a crystal, a clock can be applied at the X1 input. If no clock or crystal is present, then no clock is output at either XOUT or CLKOUT.
2, 9	SMSEL0, SMSEL1	Spread-Spectrum Magnitude Select. These are three-state digital inputs to determine the spread-spectrum magnitude. Tables 1 and 2 provide details for configuration of these pins for down and center dither, respectively.

PIN	NAME	FUNCTION
3, 8	VCC	Supply Voltage
4, 7	GND	Ground
5	CLKOUT	Clock Output. Spread-spectrum-capable digital output clock from the PLL.
6	XOUT	Crystal Buffered Output. Buffered digital output of the input crystal or clock.
10	X2	Crystal Drive Output. A crystal with the proper loading is connected across X1 and X2. If a clock is applied at the X1 input, then X2 should be left open circuit.
—	EP	Exposed Pad. Connect to GND.

Spread-Spectrum Clock Generators

Detailed Description

The MAX31C80/MAX31D80 modulate an input clock to generate a center-dithered or down-dithered spread-spectrum output. An 8MHz to 27MHz crystal or 8MHz to 134MHz oscillator input is applied to the device. An internal PLL dithers the output clock at a user-selectable magnitude to produce a down-dithered or center-dithered output clock. The output clock's frequency is programmable from 2MHz to 134MHz. The devices also

buffer the incoming clock and provide this output on a separate pin.

Spread-Spectrum Dither Magnitude

The MAX31D80 can generate down-dithered magnitudes up to -3%. The MAX31C80 can generate center-dithered magnitudes up to $\leq 1.5\%$. The desired magnitude is selected using the input pins SMSEL1 and SMSEL0 as shown in Tables 1 and 2. A power cycle is required after each change of the dither magnitude for the changes to take effect.

Table 1. Spread-Spectrum Mode and Magnitude Select (for Down Dither)

SMSEL1	SMSEL0	SPREAD-SPECTRUM MAGNITUDE SELECTED (%)	SPREAD-SPECTRUM DITHER MODE SELECTED
0	0	Spread-Spectrum Disabled	
0	Unconnected	0 to -0.25	Down Dither
0	1	0 to -0.375	
Unconnected	0	0 to -0.5	
Unconnected	Unconnected	0 to -0.75	
Unconnected	1	0 to -1.0	
1	0	0 to -1.5	
1	Unconnected	0 to -2.0	
1	1	0 to -3.0	

Table 2. Spread-Spectrum Mode and Magnitude Select (for Center Dither)

SMSEL1	SMSEL0	SPREAD-SPECTRUM MAGNITUDE SELECTED (%)	SPREAD-SPECTRUM DITHER MODE SELECTED
0	0	Spread-Spectrum Disabled	
0	Unconnected	-0.25 to +0.25	Center Dither
0	1	-0.375 to +0.375	
Unconnected	0	-0.5 to +0.5	
Unconnected	Unconnected	-0.75 to +0.75	
Unconnected	1	-1.0 to +1.0	
1	0	-1.5 to +1.5	
1	Unconnected	N/A	
1	1	N/A	

Spread-Spectrum Clock Generators

MAX31C80/MAX31D80

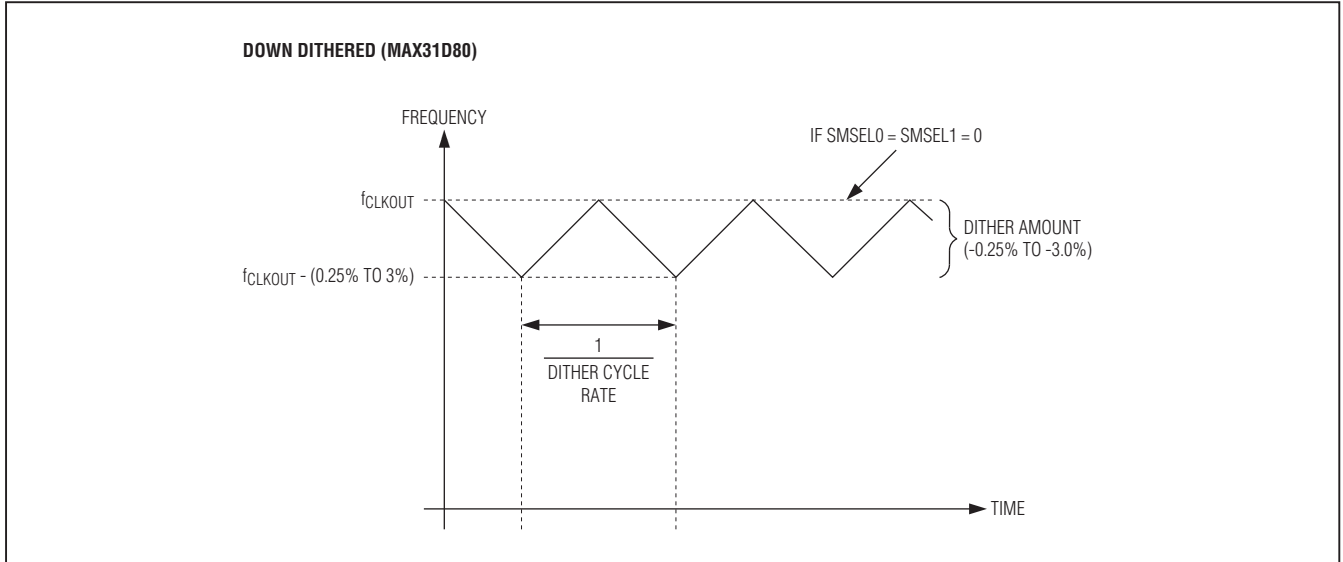

Figure 1. Spread-Spectrum Frequency Modulation (Down Dithered)

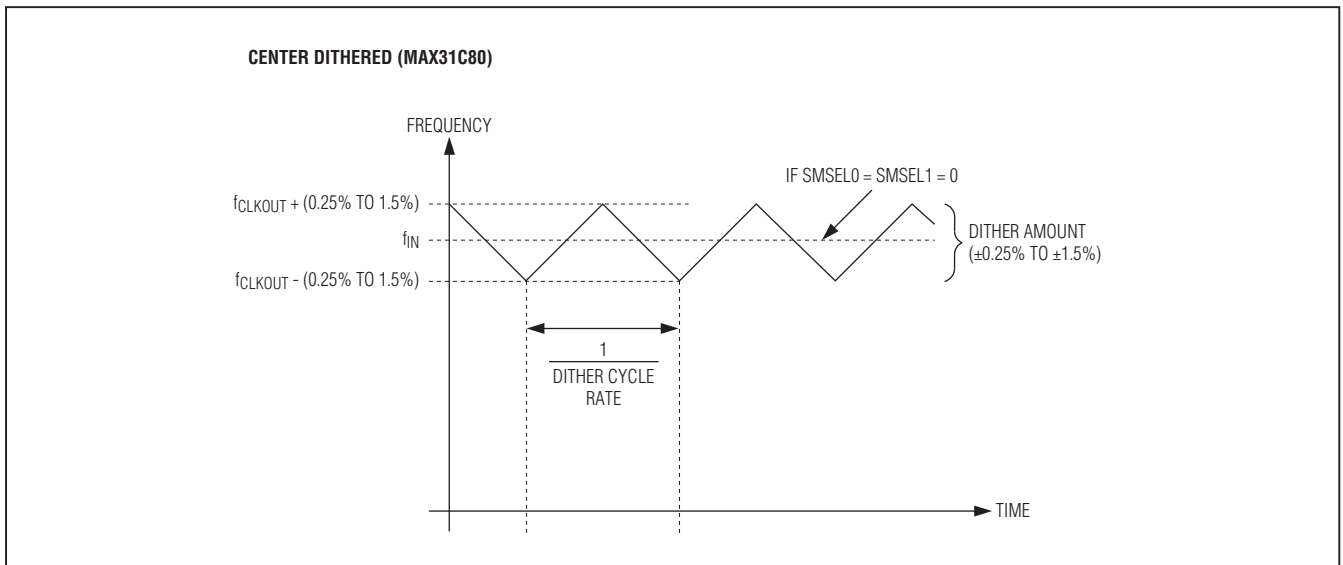

Figure 2. Spread-Spectrum Frequency Modulation (Center Dithered)

Spread-Spectrum Clock Generators

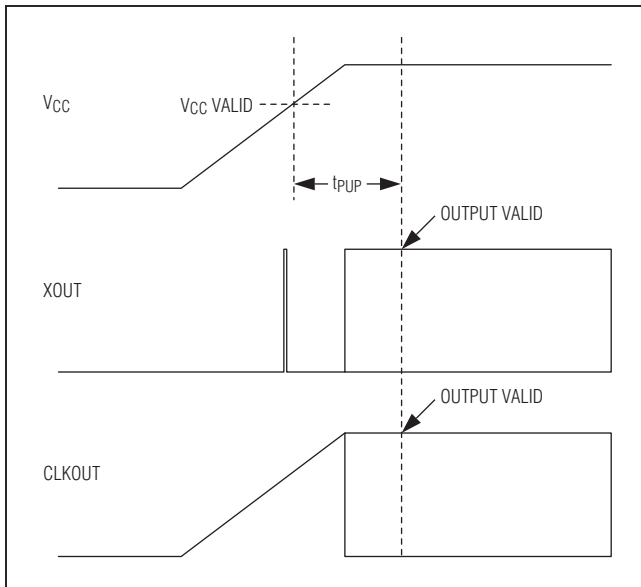

Figure 3. Power-Up Timing

Factory Programmability

The MAX31C80/MAX31D80 can provide a variety of frequencies, which are available to users by ordering the device according to specifications listed in the *Selector Guide* table.

Email the factory at custom.oscillators@maxim-ic.com to obtain custom output frequencies for specific input frequencies not mentioned in the *Selector Guide* table.

Applications Information

Power-Supply Decoupling

To achieve best results, it is highly recommended that a decoupling capacitor be used on the IC power-supply pins. Typical values of decoupling capacitors are 0.01 μ F and 0.1 μ F. Use a high-quality, ceramic, surface-mount capacitor and mount it as close as possible to the VCC pins of the IC to minimize lead inductance.

Selector Guide

PART	INPUT FREQUENCY (MHz)	OUTPUT FREQUENCY (MHz)	DITHER RATE (kHz)	DITHER TYPE
MAX31C80T -UGQ+	27	100	31.25	Center
MAX31C80T-002+	25	63.05	32.05	Center
MAX31D80T -UGQ+	27	100	31.25	Down
MAX31D80T-003+	12	12	25	Down

+Denotes a lead(Pb)-free/RoHS-compliant package.

Package Information

For the latest package outline information and land patterns, go to www.maxim-ic.com/packages. Note that a "+", "#", or "-" in the package code indicates RoHS status only. Package drawings may show a different suffix character, but the drawing pertains to the package regardless of RoHS status.

PACKAGE TYPE	PACKAGE CODE	DOCUMENT NO.
10 TDFN-EP	T1033+1	21-0137

Spread-Spectrum Clock Generators

Revision History

REVISION NUMBER	REVISION DATE	DESCRIPTION	PAGES CHANGED
0	4/10	Initial release	—



MAX31C80/MAX31D80

Maxim cannot assume responsibility for use of any circuitry other than circuitry entirely embodied in a Maxim product. No circuit patent licenses are implied. Maxim reserves the right to change the circuitry and specifications without notice at any time.

Maxim Integrated Products, 120 San Gabriel Drive, Sunnyvale, CA 94086 408-737-7600 _____ 9

Looking for pricing, stock, or lifecycle information?

Click below to explore more details on WIN SOURCE:

-  [View MAX31C80T-UGQ+T on WIN SOURCE](#)
-  [Maxim Integrated Information](#)

Optimize Your Supply Chain with WIN SOURCE Solutions

-  Global Sourcing Solution
-  Obsolete Management
-  Cost Control Management
-  Shortage Management
-  Alternative Solution
-  Excess Inventory Management