



**THE DATASHEET OF
MAX3078EESA+**



General Description

The MAX3070E–MAX3079E 3.3V, ±15kV ESD-protected, RS-485/RS-422 transceivers feature one driver and one receiver. These devices include fail-safe circuitry, guaranteeing a logic-high receiver output when receiver inputs are open or shorted. The receiver outputs a logic-high if all transmitters on a terminated bus are disabled (high impedance). The devices include a hot-swap capability to eliminate false transitions on the bus during power-up or hot insertion.

The MAX3070E/MAX3071E/MAX3072E feature reduced slew-rate drivers that minimize EMI and reduce reflections caused by improperly terminated cables, allowing error-free data transmission up to 250kbps. The MAX3073E/MAX3074E/MAX3075E also feature slew-rate-limited drivers but allow transmit speeds up to 500kbps. The MAX3076E/MAX3077E/MAX3078E driver slew rates are not limited, making transmit speeds up to 16Mbps possible. The MAX3079E slew rate is pin-selectable for 250kbps, 500kbps, and 16Mbps.

The MAX3072E/MAX3075E/MAX3078E are intended for half-duplex communications, and the MAX3070E/MAX3071E/MAX3073E/MAX3074E/MAX3076E/MAX3077E are intended for full-duplex communications. The MAX3079E is selectable for half-duplex or full-duplex operation. It also features independently programmable receiver and transmitter output phase through separate pins.

The MAX3070E–MAX3079E transceivers draw 800µA of supply current when unloaded, or when fully loaded with the drivers disabled. All devices have a 1/8-unit load receiver input impedance, allowing up to 256 transceivers on the bus.

Applications

- Lighting Systems
- Industrial Control
- Telecom
- Security Systems
- Instrumentation

Benefits and Features

- Protection for Robust Performance
 - ±15kV Human Body Model ESD on I/O Pins
 - True Fail-Safe Receiver While Maintaining EIA/TIA-485 Compatibility
 - Enhanced Slew-Rate-Limiting Facilitates Error-Free Data Transmission (MAX3070E–MAX3075E/MAX3079E)
 - Hot-Swap Input Structure on DE and \overline{RE}
- Flexible Feature Set for Ease of Design
 - Pin-Selectable Full/Half-Duplex Operation (MAX3079E)
 - Phase Controls to Correct for Twisted-Pair Reversal (MAX3079E)
 - Allows up to 256 Transceivers on the Bus
 - Available in Industry-Standard SO and DIP packages
- 10µA Shutdown Current Mode for Power Savings (Except MAX3071E/MAX3074E/MAX3077E)

[Ordering Information](#) at end of data sheet.

[Selector Guide](#), [Pin Configurations](#), and [Typical Operating Circuits](#) appear at end of data sheet.

Absolute Maximum Ratings

(All voltages referenced to GND)

Supply Voltage (V _{CC}).....	+6V
Control Input Voltage (\overline{RE} , DE, SLR, H/ \overline{F} , TXP, RXP).....	-0.3V to +6V
Driver Input Voltage (DI).....	-0.3V to +6V
Driver Output Voltage (Z, Y, A, B)	-8V to +13V
Receiver Input Voltage (A, B).....	-8V to +13V
Receiver Input Voltage Full Duplex (A, B)	-8V to +13V
Receiver Output Voltage (RO)	-0.3V to (V _{CC} + 0.3V)
Driver Output Current.....	±250mA

Continuous Power Dissipation (T _A = +70°C)	
8-Pin SO (derate 5.88mW/°C above +70°C).....	471mW
8-Pin Plastic DIP (derate 9.09mW/°C above +70°C) ..	727mW
14-Pin SO (derate 8.33mW/°C above +70°C).....	667mW
14-Pin Plastic DIP (derate 10.0mW/°C above +70°C)..	800mW
Operating Temperature Ranges	
MAX307_EE_ _	-40°C to +85°C
MAX307_EA_ _	-40°C to +125°C
MAX3077EMSA.....	-55°C to +125°C
Junction Temperature.....	+150°C
Storage Temperature Range.....	-65°C to +150°C
Lead Temperature (soldering, 10s)	+300°C

Stresses beyond those listed under "Absolute Maximum Ratings" may cause permanent damage to the device. These are stress ratings only, and functional operation of the device at these or any other conditions beyond those indicated in the operational sections of the specifications is not implied. Exposure to absolute maximum rating conditions for extended periods may affect device reliability.

DC Electrical Characteristics

(V_{CC} = 3.3V ±10%, T_A = T_{MIN} to T_{MAX}, unless otherwise noted. Typical values are at V_{CC} = 3.3V and T_A = +25°C.) (Note 1)

PARAMETER	SYMBOL	CONDITIONS	MIN	TYP	MAX	UNITS
DRIVER						
Differential Driver Output	V _{OD}	R _L = 100Ω (RS422), Figure 1	2		V _{CC}	V
		R _L = 54Ω (RS485), Figure 1	1.5		V _{CC}	
		No load			V _{CC}	
Change in Magnitude of Differential Output Voltage	ΔV _{OD}	R _L = 100Ω or 54Ω, Figure 1 (Note 2)			0.2	V
Driver Common-Mode Output Voltage	V _{OC}	R _L = 100Ω or 54Ω, Figure 1		V _{CC} /2	3	V
Change in Magnitude of Common-Mode Voltage	ΔV _{OC}	R _L = 100Ω or 54Ω, Figure 1 (Note 2)			0.2	V
Input High Voltage	V _{IH}	DE, DI, \overline{RE} , TXP, RXP, H/ \overline{F}	2			V
Input Low Voltage	V _{IL}	DE, DI, \overline{RE} , TXP, RXP, H/ \overline{F}			0.8	V
Input Hysteresis	V _{HYS}	DE, DI, \overline{RE} , TXP, RXP, H/ \overline{F}		100		mV
Input Current	I _{IN1}	DE, DI, \overline{RE}			±1	μA
Input Impedance First Transition		DE	1		10	kΩ
Input Current	I _{IN2}	TXP, RXP, H/ \overline{F} internal pulldown	10		40	μA
SRL Input High Voltage			V _{CC} - 0.4			V
SRL Input Middle Voltage			V _{CC} × 0.4		V _{CC} × 0.6	V
SRL Input Low Voltage					0.4	V
SRL Input Current		SRL = V _{CC}			75	μA
		SRL = GND	-75			
Output Leakage (Y and Z) Full Duplex	I _O	DE = GND, V _{CC} = GND or 3.6V	V _{IN} = +12V		125	μA
			V _{IN} = -7V	-100		

DC Electrical Characteristics (continued)(V_{CC} = 3.3V ±10%, T_A = T_{MIN} to T_{MAX}, unless otherwise noted. Typical values are at V_{CC} = 3.3V and T_A = +25°C.) (Note 1)

PARAMETER	SYMBOL	CONDITIONS	MIN	TYP	MAX	UNITS
Driver Short-Circuit Output Current	I _{OSD}	0 ≤ V _{OUT} ≤ 12V (Note 3)	40		250	mA
		-7V ≤ V _{OUT} ≤ V _{CC} (Note 3)	-250		-40	
Driver Short-Circuit Foldback Output Current	I _{OSDF}	(V _{CC} - 1V) ≤ V _{OUT} ≤ 12V (Note 3)	20			mA
		-7V ≤ V _{OUT} ≤ 1V (Note 3)			-20	
Thermal-Shutdown Threshold	T _{TS}			175		°C
Thermal-Shutdown Hysteresis	T _{TSH}			15		°C
Input Current (A and B)	I _{A, B}	DE = GND, V _{CC} = GND or 3.6V	V _{IN} = +12V		125	μA
			V _{IN} = -7V	-100		
RECEIVER						
Receiver Differential Threshold Voltage	V _{TH}	-7V ≤ V _{CM} ≤ 12V	-200	-125	-50	mV
Receiver Input Hysteresis	ΔV _{TH}	V _A + V _B = 0V		15		mV
RO Output High Voltage	V _{OH}	I _O = -1mA	V _{CC} - 0.6			V
RO Output Low Voltage	V _{OL}	I _O = 1mA			0.4	V
Three-State Output Current at Receiver	I _{OZR}	0 ≤ V _O ≤ V _{CC}			±1	μA
Receiver Input Resistance	R _{IN}	-7V ≤ V _{CM} ≤ 12V	96			kΩ
Receiver Output Short-Circuit Current	I _{OSR}	0V ≤ V _{RO} ≤ V _{CC}			±80	mA
SUPPLY CURRENT						
Supply Current	I _{CC}	No load, $\overline{RE} = 0$, DE = V _{CC}		0.8	1.5	mA
		No load, $\overline{RE} = V_{CC}$, DE = V _{CC}		0.8	1.5	
		No load, $\overline{RE} = 0$, DE = 0		0.8	1.5	
Supply Current in Shutdown Mode	I _{SHDN}	$\overline{RE} = V_{CC}$, DE = GND		0.05	10	μA
ESD PROTECTION						
ESD Protection for Y, Z, A, and B		Human Body Model		±15		kV

Note 1: All currents into the device are positive. All currents out of the device are negative. All voltages are referred to device ground, unless otherwise noted.

Note 2: ΔV_{OD} and ΔV_{OC} are the changes in V_{OD} and V_{OC}, respectively, when the DI input changes state.

Note 3: The short-circuit output current applies to peak current just prior to foldback current limiting. The short-circuit foldback output current applies during current limiting to allow a recovery from bus contention.

Switching Characteristics

Driver Switching Characteristics

MAX3070E/MAX3071E/MAX3072E/MAX3079E with SRL = UNCONNECTED (250kbps)

($V_{CC} = 3.3V \pm 10\%$, $T_A = T_{MIN}$ to T_{MAX} , unless otherwise noted. Typical values are at $V_{CC} = 3.3V$ and $T_A = +25^\circ C$.)

PARAMETER	SYMBOL	CONDITIONS	MIN	TYP	MAX	UNITS
Driver Propagation Delay	t_{DPLH}	$C_L = 50pF$, $R_L = 54\Omega$, Figures 2 and 3	250		1500	ns
	t_{DPHL}		250		1500	
Driver Differential Output Rise or Fall Time	t_{DR} , t_{DF}	$C_L = 50pF$, $R_L = 54\Omega$, Figures 2 and 3	350		1600	ns
Differential Driver Output Skew $ t_{DPLH} - t_{DPHL} $	t_{DSKEW}	$C_L = 50pF$, $R_L = 54\Omega$, Figures 2 and 3			200	ns
Maximum Data Rate			250			kbps
Driver Enable to Output High	t_{DZH}	Figure 4			2500	ns
Driver Enable to Output Low	t_{DZL}	Figure 5			2500	ns
Driver Disable Time from Low	t_{DLZ}	Figure 5			100	ns
Driver Disable Time from High	t_{DHZ}	Figure 4			100	ns
Driver Enable from Shutdown to Output High	$t_{DZH(SHDN)}$	Figure 4			5500	ns
Driver Enable from Shutdown to Output Low	$t_{DZL(SHDN)}$	Figure 5			5500	ns
Time to Shutdown	t_{SHDN}		50	200	600	ns

Receiver Switching Characteristics

MAX3070E/MAX3071E/MAX3072E/MAX3079E with SRL = UNCONNECTED (250kbps)

($V_{CC} = 3.3V \pm 10\%$, $T_A = T_{MIN}$ to T_{MAX} , unless otherwise noted. Typical values are at $V_{CC} = 3.3V$ and $T_A = +25^\circ C$.)

PARAMETER	SYMBOL	CONDITIONS	MIN	TYP	MAX	UNITS
Receiver Propagation Delay	t_{RPLH}	$C_L = 15pF$, Figures 6 and 7			200	ns
	t_{RPHL}				200	
Receiver Output Skew $ t_{RPLH} - t_{RPHL} $	t_{RSKEW}	$C_L = 15pF$, Figures 6 and 7			30	ns
Maximum Data Rate			250			kbps
Receiver Enable to Output Low	t_{RZL}	Figure 8			50	ns
Receiver Enable to Output High	t_{RZH}	Figure 8			50	ns
Receiver Disable Time from Low	t_{RLZ}	Figure 8			50	ns
Receiver Disable Time from High	t_{RHZ}	Figure 8			50	ns
Receiver Enable from Shutdown to Output High	$t_{RZH(SHDN)}$	Figure 8			4000	ns
Receiver Enable from Shutdown to Output Low	$t_{RZL(SHDN)}$	Figure 8			4000	ns
Time to Shutdown	t_{SHDN}		50	200	600	ns

Driver Switching Characteristics**MAX3073E/MAX3074E/MAX3075E/MAX3079E with SRL = V_{CC} (500kbps)**(V_{CC} = 3.3V ±10%, T_A = T_{MIN} to T_{MAX}, unless otherwise noted. Typical values are at V_{CC} = 3.3V and T_A = +25°C.)

PARAMETER	SYMBOL	CONDITIONS	MIN	TYP	MAX	UNITS
Driver Propagation Delay	t _{DPLH}	C _L = 50pF, R _L = 54Ω, Figures 2 and 3	180		800	ns
	t _{DPHL}		180		800	
Driver Differential Output Rise or Fall Time	t _{DR} , t _{DF}	C _L = 50pF, R _L = 54Ω, Figures 2 and 3	200		800	ns
Differential Driver Output Skew t _{DPLH} - t _{DPHL}	t _{DSKEW}	C _L = 50pF, R _L = 54Ω, Figures 2 and 3			100	ns
Maximum Data Rate			500			kbps
Driver Enable to Output High	t _{DZH}	Figure 4			2500	ns
Driver Enable to Output Low	t _{DZL}	Figure 5			2500	ns
Driver Disable Time from Low	t _{DLZ}	Figure 5			100	ns
Driver Disable Time from High	t _{DHZ}	Figure 4			100	ns
Driver Enable from Shutdown to Output High	t _{DZH(SHDN)}	Figure 4			4500	ns
Driver Enable from Shutdown to Output Low	t _{DZL(SHDN)}	Figure 5			4500	ns
Time to Shutdown	t _{SHDN}		50	200	600	ns

Receiver Switching Characteristics**MAX3073E/MAX3074E/MAX3075E/MAX3079E with SRL = V_{CC} (500kbps)**(V_{CC} = 3.3V ±10%, T_A = T_{MIN} to T_{MAX}, unless otherwise noted. Typical values are at V_{CC} = 3.3V and T_A = +25°C.)

PARAMETER	SYMBOL	CONDITIONS	MIN	TYP	MAX	UNITS
Receiver Propagation Delay	t _{RPLH}	C _L = 15pF, Figures 6 and 7			200	ns
	t _{RPHL}				200	
Receiver Output Skew t _{RPLH} - t _{RPHL}	t _{RSKEW}	C _L = 15pF, Figures 6 and 7			30	ns
Maximum Data Rate			500			kbps
Receiver Enable to Output Low	t _{RZL}	Figure 8			50	ns
Receiver Enable to Output High	t _{RZH}	Figure 8			50	ns
Receiver Disable Time from Low	t _{RLZ}	Figure 8			50	ns
Receiver Disable Time from High	t _{RHZ}	Figure 8			50	ns
Receiver Enable from Shutdown to Output High	t _{RZH(SHDN)}	Figure 8			4000	ns
Receiver Enable from Shutdown to Output Low	t _{RZL(SHDN)}	Figure 8			4000	ns
Time to Shutdown	t _{SHDN}		50	200	600	ns

Driver Switching Characteristics**MAX3076E/MAX3077E/MAX3078E/MAX3079E with SRL = GND (16Mbps)**(V_{CC} = 3.3V ±10%, T_A = T_{MIN} to T_{MAX}, unless otherwise noted. Typical values are at V_{CC} = 3.3V and T_A = +25°C.)

PARAMETER	SYMBOL	CONDITIONS	MIN	TYP	MAX	UNITS
Driver Propagation Delay	t _{DPLH}	C _L = 50pF, R _L = 54Ω, Figures 2 and 3			50	ns
	t _{DPHL}				50	
Driver Differential Output Rise or Fall Time	t _{DR} , t _{DF}	C _L = 50pF, R _L = 54Ω, Figures 2 and 3			15	ns
Differential Driver Output Skew t _{DPLH} - t _{DPHL}	t _{DSKEW}	C _L = 50pF, R _L = 54Ω, Figures 2 and 3			8	ns
Maximum Data Rate			16			Mbps
Driver Enable to Output High	t _{DZH}	Figure 4			150	ns
Driver Enable to Output Low	t _{DZL}	Figure 5			150	ns
Driver Disable Time from Low	t _{DLZ}	Figure 5			100	ns
Driver Disable Time from High	t _{DHZ}	Figure 4			100	ns
Driver Enable from Shutdown to Output High	t _{DZH(SHDN)}	Figure 4		1250	1800	ns
Driver Enable from Shutdown to Output Low	t _{DZL(SHDN)}	Figure 5		1250	1800	ns
Time to Shutdown	t _{SHDN}		50	200	600	ns

Receiver Switching Characteristics**MAX3076E/MAX3077E/MAX3078E/MAX3079E with SRL = GND (16Mbps)**(V_{CC} = 3.3V ±10%, T_A = T_{MIN} to T_{MAX}, unless otherwise noted. Typical values are at V_{CC} = 3.3V and T_A = +25°C.)

PARAMETER	SYMBOL	CONDITIONS	MIN	TYP	MAX	UNITS
Receiver Propagation Delay	t _{RPLH}	C _L = 15pF, Figures 6 and 7		40	75	ns
	t _{RPHL}			40	75	
Receiver Output Skew t _{RPLH} - t _{RPHL}	t _{RSKEW}	C _L = 15pF, Figures 6 and 7			8	ns
Maximum Data Rate			16			Mbps
Receiver Enable to Output Low	t _{RZL}	Figure 8			50	ns
Receiver Enable to Output High	t _{RZH}	Figure 8			50	ns
Receiver Disable Time from Low	t _{RLZ}	Figure 8			50	ns
Receiver Disable Time from High	t _{RHZ}	Figure 8			50	ns
Receiver Enable from Shutdown to Output High	t _{RZH(SHDN)}	Figure 8			1800	ns
Receiver Enable from Shutdown to Output Low	t _{RZL(SHDN)}	Figure 8			1800	ns
Time to Shutdown	t _{SHDN}		50	200	600	ns

Typical Operating Characteristics

(V_{CC} = 3.3V, T_A = +25°C, unless otherwise noted. **Note:** The MAX3077EMSA/PR meets specification over temperature.)

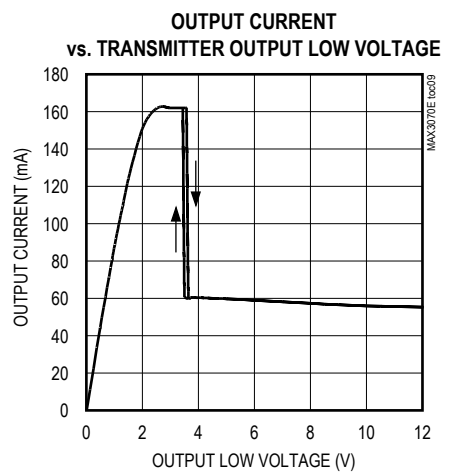
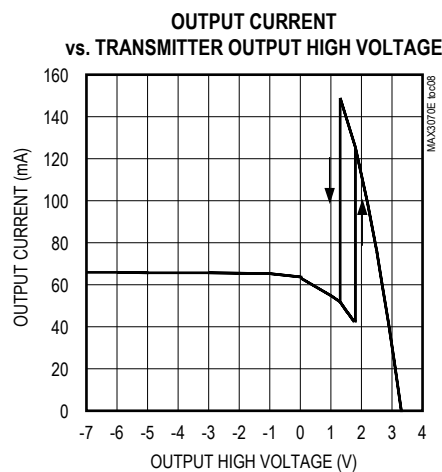
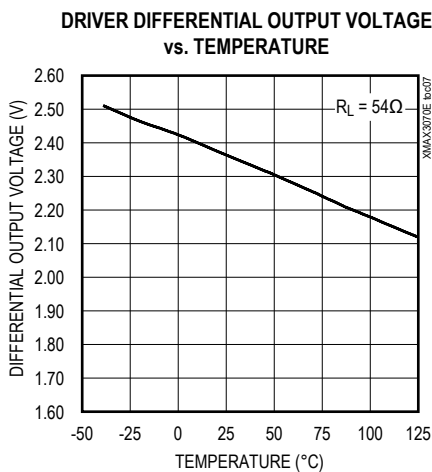
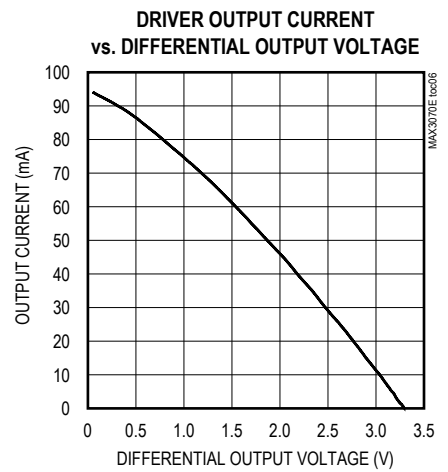
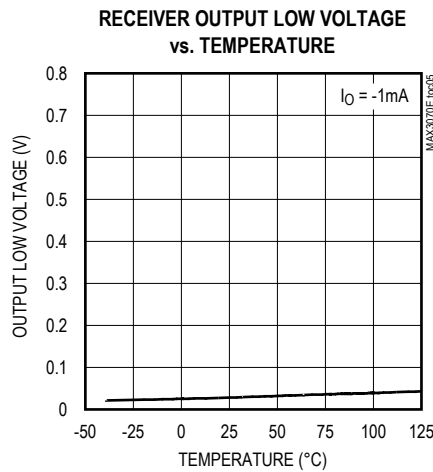
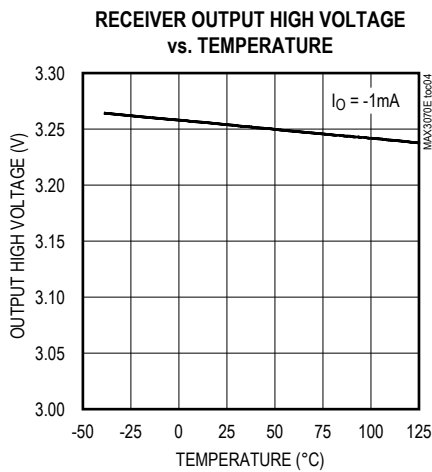
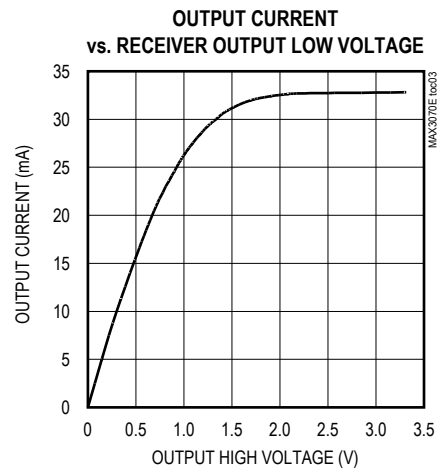
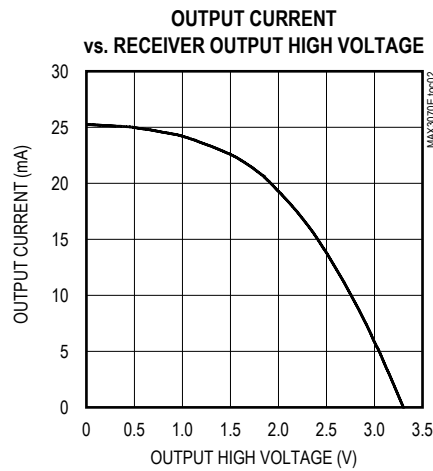
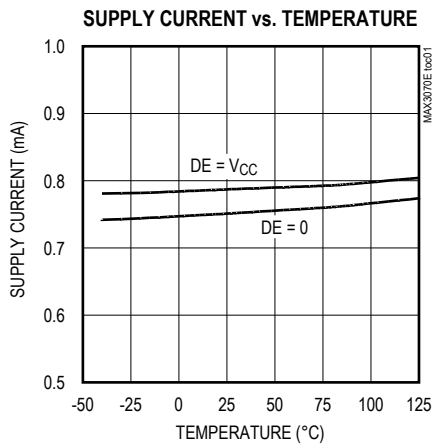

Typical Operating Characteristics (continued)

($V_{CC} = 3.3V$, $T_A = +25^\circ C$, unless otherwise noted. **Note:** The MAX3077EMSA/PR meets specification over temperature.)

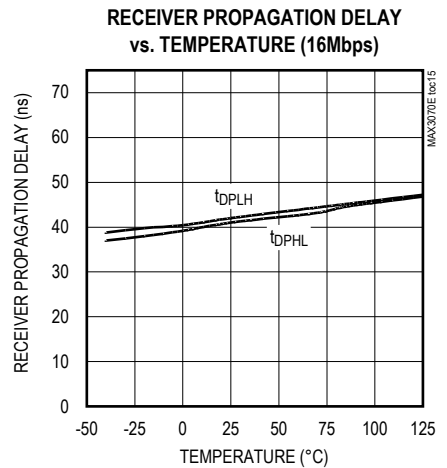
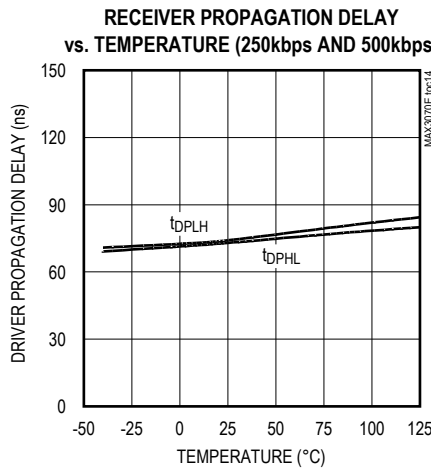
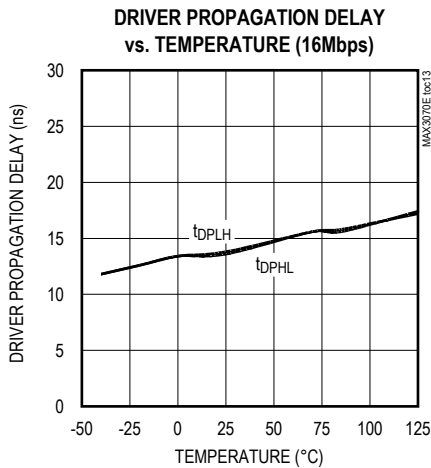
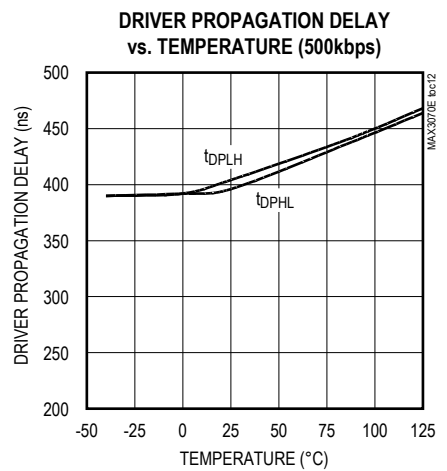
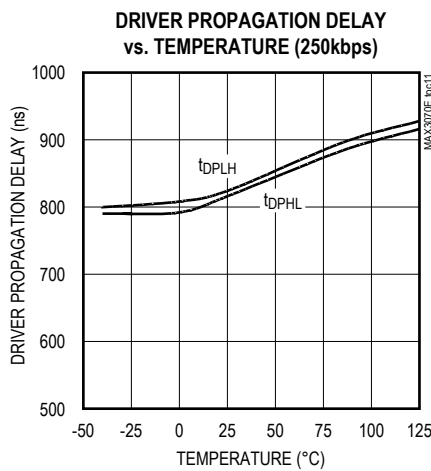

Typical Operating Characteristics (continued)

($V_{CC} = 3.3V$, $T_A = +25^\circ C$, unless otherwise noted. **Note:** The MAX3077EMSA/PR meets specification over temperature.)

DRIVER PROPAGATION DELAY (500kbps)



DRIVER PROPAGATION DELAY (16Mbps)



RECEIVER PROPAGATION DELAY (16Mbps)

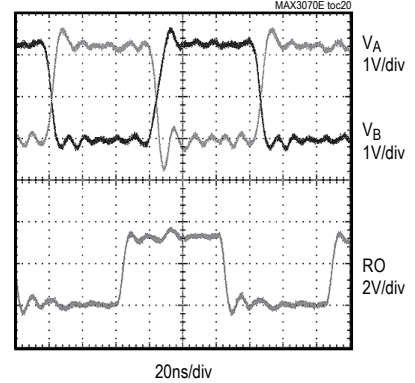

Test Circuits and Waveforms

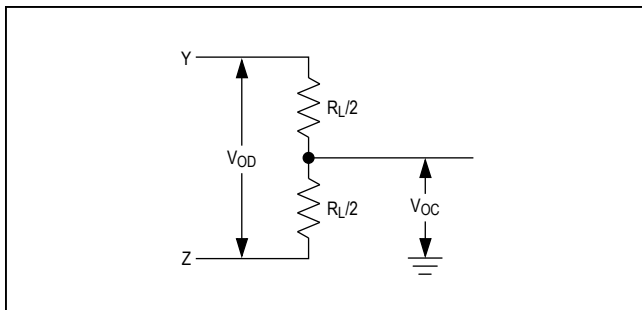

Figure 1. Driver DC Test Load

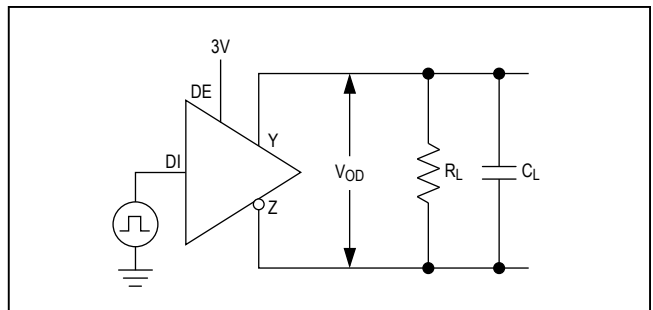

Figure 2. Driver Timing Test Circuit

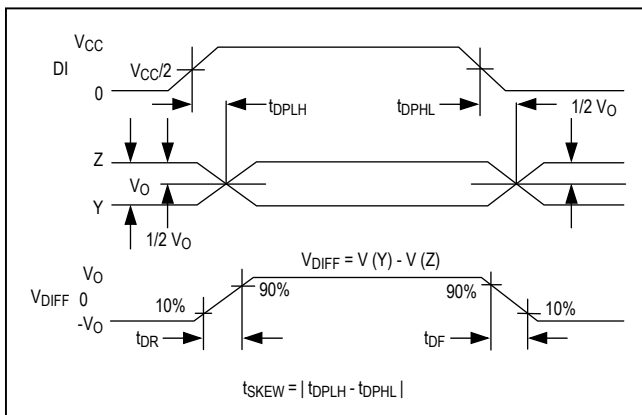

Figure 3. Driver Propagation Delays

Test Circuits and Waveforms (continued)



Figure 4. Driver Enable and Disable Times (t_{DZH} , $t_{DZH(SHDN)}$, t_{DZL})



Figure 5. Driver Enable and Disable Times (t_{DZH} , $t_{DZH(SHDN)}$, t_{DZL})

Test Circuits and Waveforms (continued)



Figure 6. Receiver Propagation Delay Test Circuit

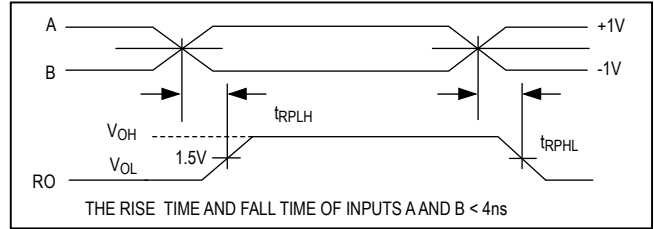

Figure 7. Receiver Propagation Delays

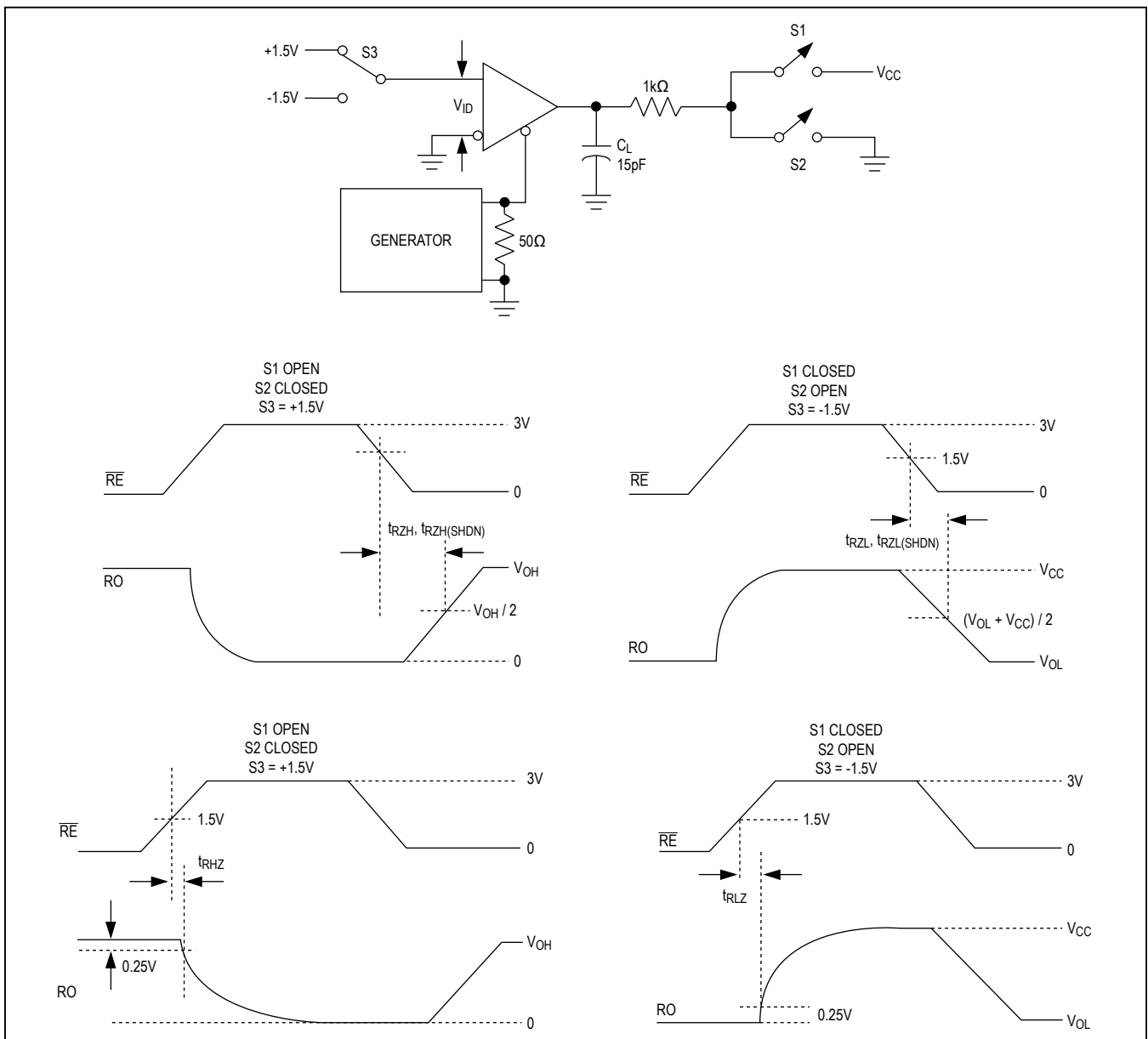

Figure 8. Receiver Enable and Disable Times

Pin Description

PIN					NAME	FUNCTION
MAX3070E MAX3073E MAX3076E	MAX3071E MAX3074E MAX3077E	MAX3072E MAX3075E MAX3078E	MAX3079E			
FULL-DUPLEX DEVICES		HALF- DUPLEX DEVICES	FULL- DUPLEX MODE	HALF- DUPLEX MODE		
—	—	—	1	1	H/ \overline{F}	Half-/Full-Duplex Select Pin. Connect H/ \overline{F} to V_{CC} for half-duplex mode; connect to GND or leave unconnected for full-duplex mode.
2	2	1	2	2	RO	Receiver Output. When \overline{RE} is low and if $(A - B) \geq -50\text{mV}$, RO is high; if $(A - B) \leq -200\text{mV}$, RO is low.
3	—	2	3	3	\overline{RE}	Receiver Output Enable. Drive \overline{RE} low to enable RO; RO is high impedance when \overline{RE} is high. Drive \overline{RE} high and DE low to enter low-power shutdown mode. \overline{RE} is a hot-swap input (see the <i>Hot-Swap Capability</i> section for details).
4	—	3	4	4	DE	Driver Output Enable. Drive DE high to enable driver outputs. These outputs are high impedance when DE is low. Drive \overline{RE} high and DE low to enter low-power shutdown mode. DE is a hot-swap input (see the <i>Hot-Swap Capability</i> section for details).
5	3	4	5	5	DI	Driver Input. With DE high, a low on DI forces noninverting output low and inverting output high. Similarly, a high on DI forces noninverting output high and inverting output low.
—	—	—	6	6	SRL	Slew-Rate Limit Selector Pin. Connect SRL to ground for 16Mbps communication rate; connect to V_{CC} for 500kbps communication rate. Leave unconnected for 250kbps communication rate.
6, 7	4	5	7	7	GND	Ground
—	—	—	8	8	TXP	Transmitter Phase. Connect TXP to ground or leave unconnected for normal transmitter phase/polarity. Connect to V_{CC} to invert the transmitter phase/polarity.
9	5	—	9	—	Y	Noninverting Driver Output
—	—	—	—	9	Y	Noninverting Driver Output and Noninverting Receiver Input*
10	6	—	10	—	Z	Inverting Driver Output
—	—	—	—	10	Z	Inverting Driver Output and Inverting Receiver Input*
11	7	—	11	—	B	Inverting Receiver Input
—	—	—	—	11	B	Receiver Input Resistors*
—	—	7	—	—	B	Inverting Receiver Input and Inverting Driver Output

Pin Description (continued)

PIN					NAME	FUNCTION
MAX3070E MAX3073E MAX3076E	MAX3071E MAX3074E MAX3077E	MAX3072E MAX3075E MAX3078E	MAX3079E			
FULL-DUPLEX DEVICES		HALF-DUPLEX DEVICES	FULL-DUPLEX MODE	HALF-DUPLEX MODE		
12	8	—	12	—	A	Noninverting Receiver Input
—	—	—	—	12	A	Receiver Input Resistors*
—	—	6	—	—	A	Noninverting Receiver Input and Noninverting Driver Output
—	—	—	13	13	RXP	Receiver Phase. Connect RXP to GND or leave unconnected for normal transmitter phase/polarity. Connect to V _{CC} to invert receiver phase/polarity.
14	1	8	14	14	V _{CC}	Positive Supply V _{CC} = 3.3V ±10%. Bypass V _{CC} to GND with a 0.1µF capacitor.
1, 8, 13	—	—	—	—	N.C.	No Connect. Not internally connected. Can be connected to GND.

*MAX3079E only. In half-duplex mode, the driver outputs serve as receiver inputs. The full-duplex receiver inputs (A and B) still have a 1/8-unit load, but are not connected to the receiver.

Function Tables

MAX3070E/MAX3073E/MAX3076E

TRANSMITTING				
INPUTS			OUTPUTS	
RE	DE	DI	Z	Y
X	1	1	0	1
X	1	0	1	0
0	0	X	High-Z	High-Z
1	0	X	Shutdown	
RECEIVING				
INPUTS			OUTPUT	
RE	DE	A, B	RO	
0	X	≥ -50mV	1	
0	X	≤ -200mV	0	
0	X	Open/shorted	1	
1	1	X	High-Z	
1	0	X	Shutdown	

MAX3071E/MAX3074E/MAX3077E

TRANSMITTING		
INPUT	OUTPUTS	
DI	Z	Y
1	0	1
0	1	0
RECEIVING		
INPUTS	OUTPUT	
A, B	RO	
≥ -50mV	1	
≤ -200mV	0	
Open/shorted	1	

MAX3070E–MAX3079E

+3.3V, ±15kV ESD-Protected, Fail-Safe, Hot-Swap, RS-485/RS-422 Transceivers

Function Tables (continued)

MAX3072E/MAX3075E/MAX3078E

TRANSMITTING				
INPUTS			OUTPUTS	
\overline{RE}	DE	DI	B/Z	A/Y
X	1	1	0	1
X	1	0	1	0
0	0	X	High-Z	High-Z
1	0	X	Shutdown	

RECEIVING			
INPUTS			OUTPUTS
\overline{RE}	DE	A-B	RO
0	X	$\geq -50mV$	1
0	X	$\leq -200mV$	0
0	X	Open/shorted	1
1	1	X	High-Z
1	0	X	Shutdown

MAX3079E

TRANSMITTING						
INPUTS				OUTPUTS		
TXP	\overline{RE}	DE	DI	Z	Y	
0	X	1	1	0	1	
0	X	1	0	1	0	
1	X	1	1	1	0	
1	X	1	0	0	1	
X	0	0	X	High-Z	High-Z	
X	1	0	X	Shutdown		
RECEIVING						
INPUTS					OUTPUTS	
H/F	RXP	\overline{RE}	DE	A, B	Y, Z	RO
0	0	0	X	$> -50mV$	X	1
0	0	0	X	$< -200mV$	X	0
0	1	0	X	$> -50mV$	X	0
0	1	0	X	$< -200mV$	X	1
1	0	0	0	X	$> -50mV$	1
1	0	0	0	X	$< -200mV$	0
1	1	0	0	X	$> -50mV$	0
1	1	0	0	X	$< -200mV$	1
0	0	0	X	Open/shorted	X	1
1	0	0	0	X	Open/shorted	1
0	1	0	X	Open/shorted	X	0
1	1	0	0	X	Open/shorted	0
X	X	1	1	X	X	High-Z
X	X	1	0	X	X	Shutdown

X = Don't care; shutdown mode, driver and receiver outputs are high impedance.

Detailed Description

The MAX3070E–MAX3079E high-speed transceivers for RS-485/RS-422 communication contain one driver and one receiver. These devices feature fail-safe circuitry, which guarantees a logic-high receiver output when the receiver inputs are open or shorted, or when they are connected to a terminated transmission line with all drivers disabled (see the [Fail-Safe](#) section). The devices also feature a hot-swap capability allowing line insertion without erroneous data transfer (see the [Hot-Swap Capability](#) section). The MAX3070E/MAX3071E/MAX3072E feature reduced slew-rate drivers that minimize EMI and reduce reflections caused by improperly terminated cables, allowing error-free data transmission up to 250kbps. The MAX3073E/MAX3074E/MAX3075E also offer slew-rate limits allowing transmit speeds up to 500kbps. The MAX3076E/MAX3077E/MAX3078Es' driver slew rates are not limited, making transmit speeds up to 16Mbps possible. The MAX3079E's slew rate is selectable between 250kbps, 500kbps, and 16Mbps by driving a selector pin with a three-state driver.

The MAX3072E/MAX3075E/MAX3078E are half-duplex transceivers, while the MAX3070E/MAX3071E/MAX3073E/MAX3074E/MAX3076E/MAX3077E are full-duplex transceivers. The MAX3079E is selectable between half and full-duplex communication by driving a selector pin (SRL) high or low, respectively.

All devices operate from a single 3.3V supply. Drivers are output short-circuit current limited. Thermal-shutdown circuitry protects drivers against excessive power dissipation. When activated, the thermal-shutdown circuitry places the driver outputs into a high-impedance state.

Receiver Input Filtering

The receivers of the MAX3070E–MAX3075E, and the MAX3079E when operating in 250kbps or 500kbps mode, incorporate input filtering in addition to input hysteresis. This filtering enhances noise immunity with differential signals that have very slow rise and fall times. Receiver propagation delay increases by 25% due to this filtering.

Fail-Safe

The MAX3070E family guarantees a logic-high receiver output when the receiver inputs are shorted or open, or when they are connected to a terminated transmission line with all drivers disabled. This is done by setting the receiver input threshold between -50mV and -200mV. If the differential receiver input voltage ($A - B$) is greater than or equal to -50mV, RO is logic-high. If $A - B$ is less than or equal to -200mV, RO is logic-low. In the case of a

terminated bus with all transmitters disabled, the receiver's differential input voltage is pulled to 0V by the termination. With the receiver thresholds of the MAX3070E family, this results in a logic high with a 50mV minimum noise margin. Unlike previous fail-safe devices, the -50mV to -200mV threshold complies with the ±200mV EIA/TIA-485 standard.

Hot-Swap Capability (Except MAX3071E/MAX3074E/MAX3077E)

Hot-Swap Inputs

When circuit boards are inserted into a hot, or powered, backplane, differential disturbances to the data bus can lead to data errors. Upon initial circuit board insertion, the data communication processor undergoes its own power-up sequence. During this period, the processor's logic-output drivers are high impedance and are unable to drive the DE and \overline{RE} inputs of these devices to a defined logic level. Leakage currents up to ±10μA from the high-impedance state of the processor's logic drivers could cause standard CMOS enable inputs of a transceiver to drift to an incorrect logic level. Additionally, parasitic circuit board capacitance could cause coupling of V_{CC} or GND to the enable inputs. Without the hot-swap capability, these factors could improperly enable the transceiver's driver or receiver.

When V_{CC} rises, an internal pulldown circuit holds DE low and \overline{RE} high. After the initial power-up sequence, the pulldown circuit becomes transparent, resetting the hot-swap tolerable input.

Hot-Swap Input Circuitry

The enable inputs feature hot-swap capability. At the input there are two NMOS devices, M1 and M2 ([Figure 9](#)). When V_{CC} ramps from zero, an internal 10μs timer turns on M2 and sets the SR latch, which also turns on M1. Transistors M2, a 500μA current sink, and M1, a 100μA current sink, pull DE to GND through a 5kΩ resistor. M2 is designed to pull DE to the disabled state against an external parasitic capacitance up to 100pF that can drive DE high. After 10μs, the timer deactivates M2 while M1 remains on, holding DE low against three-state leakages that can drive DE high. M1 remains on until an external source overcomes the required input current. At this time, the SR latch resets and M1 turns off. When M1 turns off, DE reverts to a standard, high-impedance CMOS input. Whenever V_{CC} drops below 1V, the hot-swap input is reset.

For \overline{RE} there is a complementary circuit employing two PMOS devices pulling \overline{RE} to V_{CC} .



Figure 9. Simplified Structure of the Driver Enable Pin (DE)

MAX3079E Programming

The MAX3079E has several programmable operating modes. Transmitter rise and fall times are programmable, resulting in maximum data rates of 250kbps, 500kbps, and 16Mbps. To select the desired data rate, drive SRL to one of three possible states by using a three-state driver: V_{CC} , GND, or unconnected. For 250kbps operation, set the three-state device in high-impedance mode or leave SRL unconnected. For 500kbps operation, drive SRL high or connect it to V_{CC} . For 16Mbps operation, drive SRL low or connect it to GND. SRL can be changed during operation without interrupting data communications.

Occasionally, twisted-pair lines are connected backward from normal orientation. The MAX3079E has two pins that invert the phase of the driver and the receiver to correct this problem. For normal operation, drive TXP and RXP low, connect them to ground, or leave them unconnected (internal pulldown). To invert the driver phase, drive TXP high or connect it to V_{CC} . To invert the receiver phase, drive RXP high or connect it to V_{CC} . Note that the receiver threshold is positive when RXP is high.

The MAX3079E can operate in full/half-duplex mode. Drive the H/F pin low, leave it unconnected (internal

pull-down), or connect it to GND for full-duplex operation. Drive H/F high for half-duplex operation. In full-duplex mode, the pin configuration of the driver and receiver is the same as that of a MAX3070E. In half-duplex mode, the receiver inputs are switched to the driver outputs, connecting outputs Y and Z to inputs A and B, respectively. In half-duplex mode, the internal full-duplex receiver input resistors are still connected to pins 11 and 12.

±15kV ESD Protection

As with all Maxim devices, ESD-protection structures are incorporated on all pins to protect against electrostatic discharges encountered during handling and assembly. The driver outputs and receiver inputs of the MAX3070E family of devices have extra protection against static electricity. Maxim’s engineers have developed state-of-the-art structures to protect these pins against ESD of ±15kV without damage. The ESD structures withstand high ESD in all states: normal operation, shutdown, and powered down. After an ESD event, the devices keep working without latchup or damage.

ESD protection can be tested in various ways. The transmitter outputs and receiver inputs of the devices are characterized for protection to the following limits:

- ±15kV using the Human Body Model
- ±6kV using the Contact Discharge method specified in IEC 1000-4-2

ESD Test Conditions

ESD performance depends on a variety of conditions. Contact Maxim for a reliability report that documents test setup, test methodology, and test results.

Human Body Model

Figure 10a shows the Human Body Model, and Figure 10b shows the current waveform it generates when discharged into a low impedance. This model consists of a 100pF capacitor charged to the ESD voltage of interest, which is then discharged into the test device through a 1.5kΩ resistor.

IEC 1000-4-2

The IEC 1000-4-2 standard covers ESD testing and performance of finished equipment. However, it does not specifically refer to integrated circuits. The MAX3070E family of devices helps you design equipment to meet IEC 1000-4-2, without the need for additional ESD-protection components.

The major difference between tests done using the Human Body Model and IEC 1000-4-2 is higher peak current in IEC 1000-4-2, because series resistance is

MAX3070E–MAX3079E

+3.3V, ±15kV ESD-Protected, Fail-Safe, Hot-Swap, RS-485/RS-422 Transceivers



Figure 10a. Human Body ESD Test Model



Figure 10b. Human Body Current Waveform



Figure 10c. IEC 1000-4-2 ESD Test Model



Figure 10d. IEC 1000-4-2 ESD Generator Current Waveform

lower in the IEC 1000-4-2 model. Hence, the ESD withstand voltage measured to IEC 1000-4-2 is generally lower than that measured using the Human Body Model. [Figure 10c](#) shows the IEC 1000-4-2 model, and [Figure 10d](#) shows the current waveform for IEC 1000-4-2 ESD Contact Discharge test.

The air-gap test involves approaching the device with a charged probe. The contact-discharge method connects the probe to the device before the probe is energized.

Machine Model

The machine model for ESD tests all pins using a 200pF storage capacitor and zero discharge resistance. The objective is to emulate the stress caused when I/O pins are contacted by handling equipment during test and assembly. Of course, all pins require this protection, not just RS-485 inputs and outputs.

Applications Information

256 Transceivers on the Bus

The standard RS-485 receiver input impedance is 12kΩ (1-unit load), and the standard driver can drive up to 32-unit loads. The MAX3070E family of transceivers has a 1/8-unit load receiver input impedance (96kΩ), allowing up to 256 transceivers to be connected in parallel on one communication line. Any combination of these devices as well as other RS-485 transceivers with a total of 32-unit loads or fewer can be connected to the line.

Reduced EMI and Reflections

The MAX3070E/MAX3071E/MAX3072E feature reduced slew-rate drivers that minimize EMI and reduce reflections caused by improperly terminated cables, allowing error-free data transmission up to 250kbps. The MAX3073E/MAX3074E/MAX3075E offer higher driver output slew-rate limits, allowing transmit speeds up to 500kbps. The MAX3079E with SRL = V_{CC} or unconnected, are slew-rate limited. With SRL unconnected, the MAX3079E error-free data transmission is up to 250kbps; with SRL connected to V_{CC} the data transmit speeds up to 500kbps.

MAX3070E–MAX3079E

+3.3V, ±15kV ESD-Protected, Fail-Safe, Hot-Swap, RS-485/RS-422 Transceivers

Low-Power Shutdown Mode (Except MAX3071E/MAX3074E/MAX3077E)

Low-power shutdown mode is initiated by bringing both \overline{RE} high and DE low. In shutdown, the devices typically draw only 50nA of supply current.

\overline{RE} and DE can be driven simultaneously; the parts are guaranteed not to enter shutdown if \overline{RE} is high and DE is low for less than 50ns. If the inputs are in this state for at least 600ns, the parts are guaranteed to enter shutdown.

Enable times t_{ZH} and t_{ZL} (see the [Switching Characteristics](#) section) assume the part was not in a low-power shutdown state. Enable times $t_{ZH}(SHDN)$ and $t_{ZL}(SHDN)$ assume the parts were shut down. It takes drivers and receivers longer to become enabled from low-power shutdown mode ($t_{ZH}(SHDN)$, $t_{ZL}(SHDN)$) than from driver/receiver-disable mode (t_{ZH} , t_{ZL}).



Figure 11. Line Repeater for MAX3070E/MAX3071E/MAX3073E/MAX3074E/MAX3076E/MAX3077E/MAX3079E in Full-Duplex Mode

Driver Output Protection

Two mechanisms prevent excessive output current and power dissipation caused by faults or by bus contention. The first, a foldback current limit on the output stage, provides immediate protection against short circuits over the whole common-mode voltage range (see the [Typical Operating Characteristics](#)). The second, a thermal-shutdown circuit, forces the driver outputs into a high-impedance state if the die temperature becomes excessive.

Line Length

The RS-485/RS-422 standard covers line lengths up to 4000ft. For line lengths greater than 4000ft, use the repeater application shown in [Figure 11](#).

Typical Applications

The MAX3072E/MAX3075E/MAX3078E/MAX3079E transceivers are designed for bidirectional data communications on multipoint bus transmission lines. [Figure 12](#) and [Figure 13](#) show typical network application circuits.

To minimize reflections, terminate the line at both ends in its characteristic impedance, and keep stub lengths off the main line as short as possible. The slew-rate-limited MAX3072E/MAX3075E and the two modes of the MAX3079E are more tolerant of imperfect termination.

Chip Information

PROCESS: BiCMOS



Figure 12. Typical Half-Duplex RS-485 Network



Figure 13. Typical Full-Duplex RS-485 Network

Selector Guide

PART	HALF/FULL-DUPLEX	DATA RATE (MBPS)	SLEW-RATE LIMITED	LOW-POWER SHUTDOWN	RECEIVER/DRIVER ENABLE	TRANSCEIVERS ON BUS	PINS
MAX3070E	Full	0.250	Yes	Yes	Yes	256	14
MAX3071E	Full	0.250	Yes	No	No	256	8
MAX3072E	Half	0.250	Yes	Yes	Yes	256	8
MAX3073E	Full	0.5	Yes	Yes	Yes	256	14
MAX3074E	Full	0.5	Yes	No	No	256	8
MAX3075E	Half	0.5	Yes	Yes	Yes	256	8
MAX3076E	Full	16	No	Yes	Yes	256	14
MAX3077E	Full	16	No	No	No	256	8
MAX3078E	Half	16	No	Yes	Yes	256	8
MAX3079E	Selectable	Selectable	Selectable	Yes	Yes	256	14

Pin Configurations and Typical Operating Circuits (continued)



MAX3070E–MAX3079E

+3.3V, ±15kV ESD-Protected, Fail-Safe, Hot-Swap, RS-485/RS-422 Transceivers

Ordering Information

PART†	TEMP RANGE	PIN-PACKAGE
MAX3070E EPD+	-40°C to +85°C	14 Plastic DIP
MAX3070EESD+	-40°C to +85°C	14 SO
MAX3070EAPD+	-40°C to +125°C	14 Plastic DIP
MAX3070EASD+	-40°C to +125°C	14 SO
MAX3071E EPA+	-40°C to +85°C	8 Plastic DIP
MAX3071EEESA+	-40°C to +85°C	8 SO
MAX3071EEAPA+	-40°C to +125°C	8 Plastic DIP
MAX3071EEASA+	-40°C to +125°C	8 SO
MAX3072E EPA+	-40°C to +85°C	8 Plastic DIP
MAX3072EEESA+	-40°C to +85°C	8 SO
MAX3072EEAPA+	-40°C to +125°C	8 Plastic DIP
MAX3072EEASA+	-40°C to +125°C	8 SO
MAX3073E EPD+	-40°C to +85°C	14 Plastic DIP
MAX3073EESD+	-40°C to +85°C	14 SO
MAX3073EAPD+	-40°C to +125°C	14 Plastic DIP
MAX3073EASD+	-40°C to +125°C	14 SO
MAX3074E EPA+	-40°C to +85°C	8 Plastic DIP
MAX3074EEESA+	-40°C to +85°C	8 SO
MAX3074EEAPA+	-40°C to +125°C	8 Plastic DIP
MAX3074EEASA+	-40°C to +125°C	8 SO
MAX3075E EPA+	-40°C to +85°C	8 Plastic DIP
MAX3075EEESA+	-40°C to +85°C	8 SO
MAX3077EEESA/V+	-40°C to +85°C	8 SO
MAX3075EEAPA+	-40°C to +125°C	8 Plastic DIP
MAX3075EEASA+	-40°C to +125°C	8 SO
MAX3076E EPD+	-40°C to +85°C	14 Plastic DIP
MAX3076EESD+	-40°C to +85°C	14 SO
MAX3076EAPD+	-40°C to +125°C	14 Plastic DIP
MAX3076EASD+	-40°C to +125°C	14 SO
MAX3077E EPA+	-40°C to +85°C	8 Plastic DIP
MAX3077EEESA+	-40°C to +85°C	8 SO
MAX3077EEESA/V+	-40°C to +85°C	8 SO
MAX3077EEAPA+	-40°C to +125°C	8 Plastic DIP
MAX3077EEASA+	-40°C to +125°C	8 SO
MAX3077EEMSA/PR+	-55°C to +125°C	8 SO
MAX3078E EPA+	-40°C to +85°C	8 Plastic DIP
MAX3078EEESA+	-40°C to +85°C	8 SO
MAX3078EEAPA+	-40°C to +125°C	8 Plastic DIP
MAX3078EEASA+	-40°C to +125°C	8 SO
MAX3079E EPD+	-40°C to +85°C	14 Plastic DIP
MAX3079EESD+	-40°C to +85°C	14 SO
MAX3079EAPD+	-40°C to +125°C	14 Plastic DIP
MAX3079EASD+	-40°C to +125°C	14 SO

†Devices are available in both leaded (Pb) and lead(Pb)-free packaging. Specify lead-free by adding a "+" after the part number.

Package Information

For the latest package outline information and land patterns (footprints), go to www.maximintegrated.com/packages. Note that a "+", "#", or "-" in the package code indicates RoHS status only. Package drawings may show a different suffix character, but the drawing pertains to the package regardless of RoHS status.

PACKAGE TYPE	PACKAGE CODE	OUTLINE NO.	LAND PATTERN NO.
8 Plastic	P8+2	21-0043	—
14 Plastic	P14+3		
8 SO	S8+4	21-0041	90-0096
14 SO	S14+1		90-0112

Revision History



REVISION NUMBER	REVISION DATE	DESCRIPTION	PAGES CHANGED
0	10/02	Initial release.	—
2	4/09	Added /PR information to reflect new characterization information for military temperature version.	2, 3, 7, 8, 12, 13, 19, 22–25
3	9/15	Updated <i>Benefits and Features</i> section and added MAX3077EESA/V+ to <i>Ordering Information</i> section for automotive customers	1, 22
4	1/16	Replaced leaded part numbers with lead-free part numbers	1, 18, 22

For pricing, delivery, and ordering information, please contact Maxim Direct at 1-888-629-4642, or visit Maxim Integrated's website at www.maximintegrated.com.

Maxim Integrated cannot assume responsibility for use of any circuitry other than circuitry entirely embodied in a Maxim Integrated product. No circuit patent licenses are implied. Maxim Integrated reserves the right to change the circuitry and specifications without notice at any time. The parametric values (min and max limits) shown in the Electrical Characteristics table are guaranteed. Other parametric values quoted in this data sheet are provided for guidance.

Looking for pricing, stock, or lifecycle information?

Click below to explore more details on WIN SOURCE:

-  [View MAX3078EESA+ on WIN SOURCE](#)
-  [Maxim Integrated Information](#)

Optimize Your Supply Chain with WIN SOURCE Solutions

-  Global Sourcing Solution
-  Obsolete Management
-  Cost Control Management
-  Shortage Management
-  Alternative Solution
-  Excess Inventory Management