



**THE DATASHEET OF
MAX3041EWE+**



±10kV ESD-Protected, Quad 5V RS-485/RS-422 Transmitters

MAX3040-MAX3045

General Description

The MAX3040-MAX3045 is a family of 5V quad RS-485/RS-422 transmitters designed for digital data transmission over twisted-pair balanced lines. All transmitter outputs are protected to ±10kV using the Human Body Model. In addition the MAX3040-MAX3045 withstand ±4kV per IEC 1000-4-4 Electrical Fast Transient/Burst Stressing. The MAX3040/MAX3043 (250kbps) and the MAX3041/MAX3044 (2.5Mbps) are slew-rate limited transmitters that minimize EMI and reduce reflections caused by improperly terminated cables, thus allowing error-free transmission.

The MAX3040-MAX3045 feature a hot-swap capability that eliminates false transitions on the data cable during power-up or hot insertion. The MAX3042B/MAX3045B are optimized for data transfer rates up to 20Mbps, the MAX3041/MAX3044 for data rates up to 2.5Mbps, and the MAX3040/MAX3043 for data rates up to 250kbps. The MAX3040-MAX3045 offer optimum performance when used with the MAX3093E or MAX3095 5V quad differential line receivers or MAX3094E/MAX3096 3V quad differential line receivers.

The MAX3040-MAX3045 are ESD-protected pin-compatible, low-power upgrades to the industry-standard 'SN75174 and 'DS26LS31C. They are available in space-saving TSSOP, narrow SO, and wide SO packages.

Applications

Telecommunications Equipment
Industrial Motor Control
Transmitter for ESD-Sensitive Applications
Hand-Held Equipment
Industrial PLCs
Networking

Selector Guide

PART	DATA RATE (bps)	INDUSTRY STANDARD PINOUT
MAX3040	250k	75174, 34C87, LTC487
MAX3041	2.5M	75174, 34C87, LTC487
MAX3042B	20M	75174, 34C87, LTC487
MAX3043	250k	26LS31
MAX3044	2.5M	26LS31
MAX3045B	20M	26LS31

Features

- ◆ ESD Protection: ±10kV—Human Body Model
- ◆ Single +5V Operation
- ◆ Guaranteed Device-to-Device Skew (MAX3040/MAX3041/MAX3043/MAX3044)
- ◆ Pin-Compatible with 'SN75174, '26LS31C and LTC487
- ◆ Hot-Swappable for Telecom Applications
- ◆ Up to 20Mbps Data Rate (MAX3042B/MAX3045B)
- ◆ Slew-Rate Limited (Data Rates at 2.5Mbps and 250kbps)
- ◆ 2nA Low-Power Shutdown Mode
- ◆ 1mA Operating Supply Current
- ◆ ±4kV EFT Fast Transient Burst Immunity per IEC 1000-4-4
- ◆ Level 2 Surge Immunity per IEC 1000-4-5, Unshielded Cable Model
- ◆ Ultra-Small 16-Pin TSSOP, 16-Pin Narrow SO, and Wide 16-Pin SO

Ordering Information

PART	TEMP RANGE	PIN-PACKAGE	DATA RATE
MAX3040CUE	0°C to +70°C	16 TSSOP	250kbps
MAX3040CSE	0°C to +70°C	16 Narrow SO	250kbps
MAX3040CWE	0°C to +70°C	16 Wide SO	250kbps
MAX3040EUE	-40°C to +85°C	16 TSSOP	250kbps
MAX3040ESE	-40°C to +85°C	16 Narrow SO	250kbps
MAX3040EWE	-40°C to +85°C	16 Wide SO	250kbps

Ordering Information continued at end of data sheet.

Pin Configurations

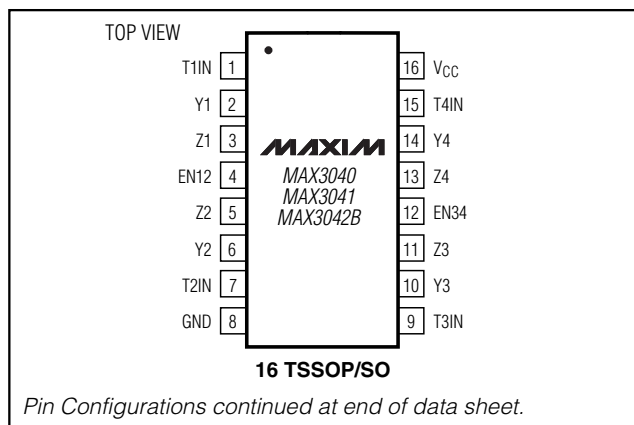

MAXIM

Maxim Integrated Products 1

For pricing, delivery, and ordering information, please contact Maxim/Dallas Direct! at 1-888-629-4642, or visit Maxim's website at www.maxim-ic.com.

±10kV ESD-Protected, Quad 5V RS-485/RS-422 Transmitters

ABSOLUTE MAXIMUM RATINGS

All voltages referenced to ground (GND).

Supply Voltage (V _{CC})	+7V
Control Input Voltage (EN, $\overline{\text{EN}}$, EN ₋)	-0.3V to (V _{CC} + 0.3V)
Driver Input Voltage (T _{IN})	-0.3V to (V _{CC} + 0.3V)
Driver Output Voltage (Y ₋ , Z ₋)	
(Driver Disabled)	-7.5V to +12.5V
Driver Output Voltage (Y ₋ , Z ₋)	
(Driver Enabled)	-7.5V to +10V
Continuous Power Dissipation (T _A = +70°C)	
16-Pin TSSOP (derate 9.4mW/°C above +70°C)	755mW

16-Pin Narrow SO (derate 8.70mW/°C above +70°C)	696mW
16-Pin Wide SO (derate 9.52mW/°C above +70°C)	762mW
Operating Temperature Range	
MAX304_C_E	0°C to +70°C
MAX304_E_E	-40°C to +85°C
Maximum Junction Temperature	+150°C
Storage Temperature Range	-65°C to +150°C
Lead Temperature (soldering, 10s)	+300°C

Stresses beyond those listed under "Absolute Maximum Ratings" may cause permanent damage to the device. These are stress ratings only, and functional operation of the device at these or any other conditions beyond those indicated in the operational sections of the specifications is not implied. Exposure to absolute maximum rating conditions for extended periods may affect device reliability.

ELECTRICAL CHARACTERISTICS

(V_{CC} = +5V ±5%, T_A = T_{MIN} to T_{MAX}, unless otherwise noted. Typical values are at V_{CC} = +5V and T_A = +25°C.) (Note 1)

PARAMETER	SYMBOL	CONDITIONS	MIN	TYP	MAX	UNITS
DRIVER						
Driver Differential Output	V _{OD}	Figure 1, R = 50Ω	2.0			V
		Figure 1, R = 27Ω	1.5			
Change in Magnitude of Differential Output Voltage	ΔV _{OD}	Figure 1, R = 50Ω or 27Ω (Note 2)			0.2	V
Driver Common-Mode Output Voltage	V _{OC}	Figure 1, R = 50Ω or 27Ω		V _{CC} / 2	3	V
Change In Magnitude of Common-Mode Voltage	ΔV _{OC}	Figure 1, R = 50Ω or 27Ω (Note 2)			0.2	V
Input High Voltage	V _{IH}	T _{IN} , EN ₋ , EN, $\overline{\text{EN}}$	2.0			V
Input Low Voltage	V _{IL}	T _{IN} , EN ₋ , EN, $\overline{\text{EN}}$			0.8	V
Hot-Swap Driver Input Current	I _{HOT SWAP}	EN ₋ , EN, $\overline{\text{EN}}$ (Note 3)			±200	μA
Driver Input Current	I _{IN}	T _{IN} , EN ₋ , EN, $\overline{\text{EN}}$			±1	μA
Driver Short-Circuit Output Current	I _{SC}	-7V ≤ V _{OUT} ≤ +10V (Note 4)	±25		±250	mA
Output Leakage (Y ₋ , Z ₋) when Disabled		MAX3040/MAX3041/MAX3042B EN ₋ = GND			±1	μA
		MAX3043/MAX3044/MAX3045B EN = GND, $\overline{\text{EN}}$ = V _{CC}				
ESD Protection (Y ₋ , Z ₋)		Human Body Model		±10		kV
Electrical Fast Transient/Burst Immunity		IEC 1000-4-4		±4		kV
SUPPLY CURRENT						
Supply Current	I _{CC}	No load		1	2	mA
Supply Current in Shutdown Mode	I _{SHDN}	MAX3040/MAX3041/MAX3042B EN ₋ = GND, T _A = +25°C		0.002	10	μA
		MAX3043/MAX3044/MAX3045B EN = GND, $\overline{\text{EN}}$ = V _{CC} , T _A = +25°C				

±10kV ESD-Protected, Quad 5V RS-485/RS-422 Transmitters

MAX3040-MAX3045

SWITCHING CHARACTERISTICS—MAX3040/MAX3043

(V_{CC} = +5V ±5%, T_A = T_{MIN} to T_{MAX}, unless otherwise noted. Typical values are at V_{CC} = +5V and T_A = +25°C.)

PARAMETER	SYMBOL	CONDITIONS		MIN	TYP	MAX	UNITS
Maximum Data Rate	f _{MAX}			250			kbps
Driver Propagation Delay	t _{PLH}	Figures 2 and 3, R _{DIFF} = 54Ω, C _{DIFF} = 50pF			0.7	1.5	μs
	t _{PHL}				0.7	1.5	
Driver Differential Output Rise-Time/Fall-Time	t _F	Figures 2 and 3, R _{DIFF} = 54Ω, C _{DIFF} = 50pF		0.48	0.75	1.33	μs
	t _R			0.48	0.75	1.33	
Skew Driver to Driver	t _{DSKEW}	Different chips	Figures 2 and 3, R _{DIFF} = 54Ω, C _{DIFF} = 50pF			±350	ns
	t _{SSKEW}	Same chip				±100	
Driver Differential Output Skew t _{PLH} - t _{PHL}	t _{SKEW}	Figures 2 and 3, R _{DIFF} = 54Ω, C _{DIFF} = 50pF				±100	ns
Driver Enable to Output High	t _{ZH}	MAX3040, Figures 4 and 5, S2 closed, R _L = 500Ω, C _L = 100pF				2.0	μs
Driver Enable from Shutdown to Output High	t _{ZH(SHDN)}	Figures 4 and 5, S2 closed, R _L = 500Ω, C _L = 100pF				2.0	μs
Driver Enable to Output Low	t _{ZL}	MAX3040, Figures 4 and 5, S1 closed, R _L = 500Ω, C _L = 100pF				2.0	μs
Driver Enable from Shutdown to Output Low	t _{ZL(SHDN)}	Figures 4 and 5, S1 closed, R _L = 500Ω, C _L = 100pF				2.0	μs
Driver Disable Time from Low	t _{LZ}	Figures 4 and 5, S1 closed, R _L = 500Ω, C _L = 15pF				500	ns
Driver Disable Time from High	t _{HZ}	Figures 4 and 5, S2 closed, R _L = 500Ω, C _L = 15pF				500	ns

SWITCHING CHARACTERISTICS—MAX3041/MAX3044

(V_{CC} = +5V ±5%, T_A = T_{MIN} to T_{MAX}, unless otherwise noted. Typical values are at V_{CC} = +5V and T_A = +25°C.)

PARAMETER	SYMBOL	CONDITIONS		MIN	TYP	MAX	UNITS
Maximum Data Rate	f _{MAX}			2.5			Mbps
Driver Propagation Delay	t _{PLH}	Figures 2 and 3, R _{DIFF} = 54Ω, C _{DIFF} = 50pF			70	150	ns
	t _{PHL}				70	150	
Driver Differential Output Rise-Time/Fall-Time	t _F	Figures 2 and 3, R _{DIFF} = 54Ω, C _{DIFF} = 50pF		33	70	133	ns
	t _R			33	70	133	
Skew Driver to Driver	t _{DSKEW}	Different chips	Figures 2 and 3, R _{DIFF} = 54Ω, C _{DIFF} = 50pF			±52	ns
	t _{SSKEW}	Same chip				±15	
Driver Differential Output Skew t _{PLH} - t _{PHL}	t _{SKEW}	Figures 2 and 3, R _{DIFF} = 54Ω, C _{DIFF} = 50pF				±15	ns
Driver Enable to Output High	t _{ZH}	MAX3041, Figures 4 and 5, S2 closed, R _L = 500Ω, C _L = 100pF				400	ns

±10kV ESD-Protected, Quad 5V RS-485/RS-422 Transmitters

SWITCHING CHARACTERISTICS—MAX3041/MAX3044 (continued)

(V_{CC} = +5V ±5%, T_A = T_{MIN} to T_{MAX}, unless otherwise noted. Typical values are at V_{CC} = +5V and T_A = +25°C.)

PARAMETER	SYMBOL	CONDITIONS	MIN	TYP	MAX	UNITS
Driver Enable from Shutdown to Output High	t _{ZH(SHDN)}	Figures 4 and 5, S2 closed, R _L = 500Ω, C _L = 100pF			400	ns
Driver Enable to Output Low	t _{ZL}	MAX3041, Figures 4 and 5, S1 closed, R _L = 500Ω, C _L = 100pF			400	ns
Driver Enable from Shutdown to Output Low	t _{ZL(SHDN)}	Figures 4 and 5, S1 closed, R _L = 500Ω, C _L = 100pF			400	ns
Driver Disable Time from Low	t _{LZ}	Figures 4 and 5, S1 closed, R _L = 500Ω, C _L = 15pF			500	ns
Driver Disable Time from High	t _{HZ}	Figures 4 and 5, S2 closed, R _L = 500Ω, C _L = 15pF			500	ns

SWITCHING CHARACTERISTICS—MAX3042B/MAX3045B

(V_{CC} = +5V ±5%, T_A = T_{MIN} to T_{MAX}, unless otherwise noted. Typical values are at V_{CC} = +5V and T_A = +25°C.)

PARAMETER	SYMBOL	CONDITIONS		MIN	TYP	MAX	UNITS
Maximum Data Rate	f _{MAX}			20			Mbps
Driver Propagation Delay	t _{PLH}	Figures 2 and 3, R _{DIFF} = 54Ω, C _{DIFF} = 50pF		23	40		ns
	t _{PHL}			23	40		
Driver Differential Output Rise-Time/Fall-Time	t _F	Figures 2 and 3, R _{DIFF} = 54Ω, C _{DIFF} = 50pF			17		ns
	t _R				17		
Skew Driver to Driver	t _{DSKEW}	Different chips	Figures 2 and 3, R _{DIFF} = 54Ω, C _{DIFF} = 50pF		±8		ns
	t _{SSKEW}	Same chip				±8	
Differential Driver Output Skew t _{PLH} - t _{PHL}	t _{SKEW}	Figures 2 and 3, R _{DIFF} = 54Ω, C _{DIFF} = 50pF				±8	ns
Driver Enable to Output High	t _{ZH}	MAX3042B, Figures 4 and 5, S2 closed, R _L = 500Ω, C _L = 100pF				300	ns
Driver Enable from Shutdown to Output High	t _{ZH(SHDN)}	Figures 4 and 5, S2 closed, R _L = 500Ω, C _L = 100pF				300	ns
Driver Enable to Output Low	t _{ZL}	MAX3042B, Figures 4 and 5, S1 closed, R _L = 500Ω, C _L = 100pF				300	ns
Driver Enable from Shutdown to Output Low	t _{ZL(SHDN)}	Figures 4 and 5, S1 closed, R _L = 500Ω, C _L = 100pF				300	ns
Driver Disable Time from Low	t _{LZ}	Figures 4 and 5, S1 closed, R _L = 500Ω, C _L = 15pF				400	ns
Driver Disable Time from High	t _{HZ}	Figures 4 and 5, S2 closed, R _L = 500Ω, C _L = 15pF				400	ns

Note 1: All currents into the device are positive; all currents out of the device are negative. All voltages are referenced to device ground unless otherwise noted.

Note 2: ΔV_{OD} and ΔV_{OC} are the changes in V_{OD} and V_{OC}, respectively, when the transmitter input changes state.

Note 3: This input current level is for the hot-swap enable (EN₋, EN, $\overline{\text{EN}}$) inputs and is present until the first transition only. After the first transition the input reverts to a standard high-impedance CMOS input with input current I_{IN}. For the first 20μs the input current may be as high as 1mA. During this period the input is disabled.

Note 4: Maximum current level applies to peak current just prior to foldback-current limiting. Minimum current level applies during current limiting.

±10kV ESD-Protected, Quad 5V RS-485/RS-422 Transmitters

Typical Operating Characteristics

(V_{CC} = +5V, T_A = +25°C, unless otherwise noted.)

MAX3040-MAX3045

MAX3040/MAX3043
SUPPLY CURRENT vs. DATA RATE



MAX3041/MAX3044
SUPPLY CURRENT vs. DATA RATE

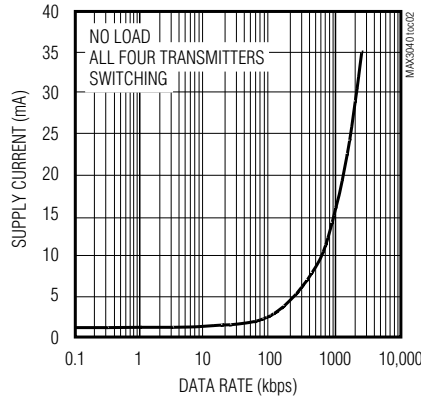

MAX3042B/MAX3045B
SUPPLY CURRENT vs. DATA RATE

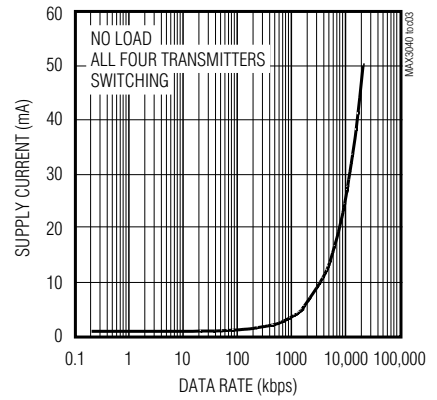

SUPPLY CURRENT vs. TEMPERATURE

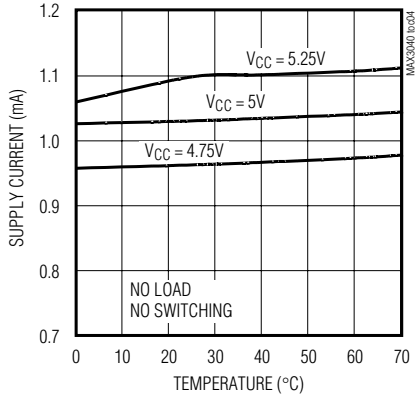

OUTPUT CURRENT vs. TRANSMITTER OUTPUT HIGH VOLTAGE

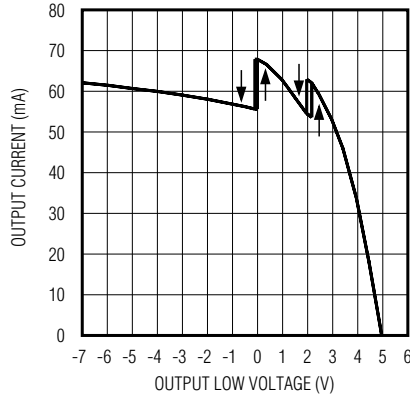

OUTPUT CURRENT vs. TRANSMITTER OUTPUT LOW VOLTAGE

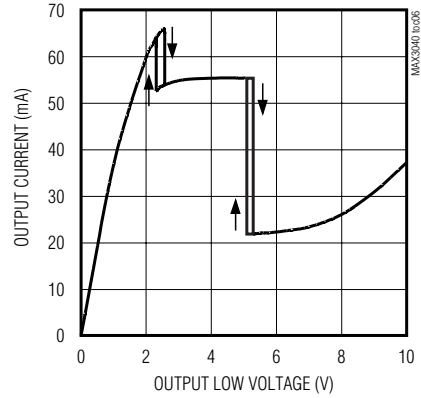

OUTPUT CURRENT vs. DIFFERENTIAL OUTPUT VOLTAGE

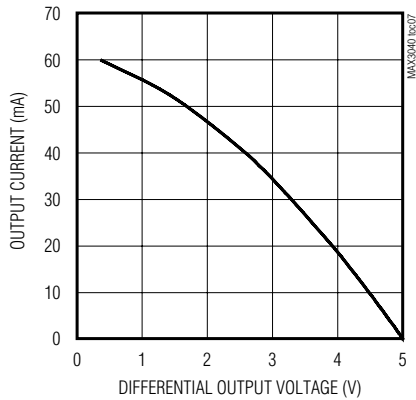

TRANSMITTER DIFFERENTIAL OUTPUT VOLTAGE vs. TEMPERATURE

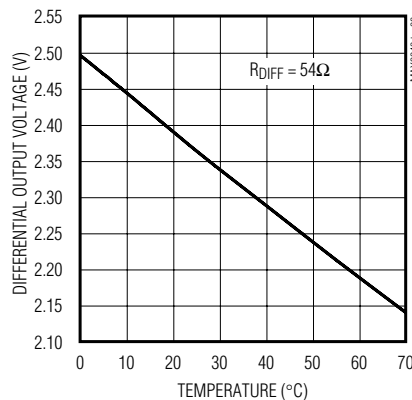

±10kV ESD-Protected, Quad 5V RS-485/RS-422 Transmitters

MAX3040-MAX3045

Pin Description

PIN		NAME	FUNCTION
MAX3040/MAX3041/ MAX3042B	MAX3043/MAX3044/ MAX3045B		
1	1	T1IN	Transmitter 1 Input
2	2	Y1	Noninverting Transmitter 1 Output
3	3	Z1	Inverting Transmitter 1 Output
—	4	EN	Transmitter Enable High Input. Drive EN high to enable all four transmitters. When EN is low and \overline{EN} is high, all transmitters are disabled and the part enters a low-power shutdown state. The transmitter outputs are high impedance when disabled.
4	—	EN12	Transmitter Enable Input to Control Transmitters 1 and 2. Drive EN12 high to enable transmitters 1 and 2. Drive EN12 low to disable transmitters 1 and 2. The transmitter outputs are high impedance when disabled. The part enters a low-power shutdown state when both EN12 and EN34 are low.
5	5	Z2	Inverting Transmitter 2 Output
6	6	Y2	Noninverting Transmitter 2 Output
7	7	T2IN	Transmitter 2 Input
8	8	GND	Ground
9	9	T3IN	Transmitter 3 Input
10	10	Y3	Noninverting Transmitter 3 Output
11	11	Z3	Inverting Transmitter 3 Output
—	12	\overline{EN}	Transmitter Enable Low Input. Drive \overline{EN} low to enable all four transmitters. When EN is low and \overline{EN} is high, all transmitters are disabled and the part enters a low-power shutdown state. The transmitter outputs are high impedance when disabled.
12	—	EN34	Transmitter Enable Input to Control Transmitters 3 and 4. Drive EN34 high to enable transmitters 3 and 4. Drive EN34 low to disable transmitters 3 and 4. The transmitter outputs are high impedance when disabled. The part enters a low-power shutdown state when both EN12 and EN34 are low.
13	13	Z4	Inverting Transmitter 4 Output
14	14	Y4	Noninverting Transmitter 4 Output
15	15	T4IN	Transmitter 4 Input
16	16	VCC	Positive Supply. Bypass with a 0.1 μ F capacitor to GND.

±10kV ESD-Protected, Quad 5V RS-485/RS-422 Transmitters

MAX3040-MAX3045

Detailed Description

The MAX3040-MAX3045 are quad RS-485/RS-422 transmitters. They operate from a single +5V power supply and are designed to give optimum performance when used with the MAX3093E/MAX3095 5V quad RS-485/RS-422 receivers or MAX3094E/MAX3096 3V quad RS-485/RS-422 receivers. The MAX3040-MAX3045 only need 1mA of operating supply current and consume 2nA when they enter a low-power shutdown mode. The MAX3040-MAX3045 also feature a hot-swap capability allowing line insertion without erroneous data transfer. The MAX3042B/MAX3045B are capable of transferring data up to 20Mbps, the MAX3041/MAX3044 for data rates up to 2.5Mbps, and the MAX3040/MAX3043 for data rates up to 250kbps. All transmitter outputs are protected to ±10kV using the Human Body Model.

±10kV ESD Protection

As with all Maxim devices, ESD-protection structures are incorporated on all pins to protect against electrostatic discharges (ESD) encountered during handling and assembly. The MAX3040-MAX3045 transmitter outputs have extra protection against electrostatic discharges found in normal operation. Maxim's engineers have developed state-of-the-art structures to protect these pins against the application of ±10kV ESD (Human Body Model), without damage.

ESD Test Conditions

ESD performance depends on a number of conditions. Contact Maxim for a reliability report that documents test setup, methodology, and results.

Human Body Model

Figure 6a shows the Human Body Model, and Figure 6b shows the current waveform it generates when discharged into low impedance. This model consists of a 100pF capacitor charged to the ESD voltage of interest, which is then discharged into the device through a 1.5kΩ resistor.



Figure 3. Driver Propagation Delays



Figure 1. Driver DC Test Circuit



Figure 4. Driver Enable/Disable Timing Test Load



Figure 2. Driver Timing Test Circuit



Figure 5. Driver Enable and Disable Times

±10kV ESD-Protected, Quad 5V RS-485/RS-422 Transmitters

Machine Model

The Machine Model for ESD testing uses a 200pF storage capacitor and zero-discharge resistance. It mimics the stress caused by handling during manufacturing and assembly. Of course, all pins (not just RS-485 inputs) require this protection during manufacturing. Therefore, the Machine Model is less relevant to the I/O ports than are the Human Body Model.

±4kV Electrical Fast Transient/Burst Testing (IEC 1000-4-4)

IEC 1000-4-4 Electrical Fast Transient/Burst (EFT/B) is an immunity test for the evaluation of electrical and electronic systems during operating conditions. The test was adapted for evaluation of integrated circuits with power applied. Repetitive fast transients with severe pulsed EMI were applied to signal and control ports. Over 15,000 distinct discharges per minute are sent to each interface port of the IC or equipment under test (EUT) simultaneously with a minimum test duration time of one minute. This simulates stress due to displacement current from electrical transients on AC mains, or other telecommunication lines in close proximity. Short rise times and very specific repetition rates are essential to the validity of the test.

Stress placed on the EUT is severe. In addition to the controlled individual discharges placed on the EUT, extraneous noise and ringing on the transmission line can multiply the number of discharges as well as increase the magnitude of each discharge. All cabling was left unterminated to simulate worst-case reflections.

The MAX3040-MAX3045 were setup as specified in IEC 1000-4-4 and the *Typical Operating Circuit* of this data sheet. The amplitude, pulse rise time, pulse duration, pulse repetition period, burst duration, and burst period (Figure 8) of the burst generator were all verified with a digital oscilloscope according to the specifications in IEC 1000-4-4 sections 6.1.1 and 6.1.2. A simplified diagram of the EFT/B generator is shown in Figure 7. The burst stresses were applied to Y1-Y4 and Z1-Z4 simultaneously.

IEC 1000-4-4 provides several levels of test severity (see Table 1). The MAX3040-MAX3045 pass the 4000V stress, a special category "X" beyond the highest level for severe (transient) industrial environments for telecommunication lines.



Figure 6a. Human Body ESD Test Model



Figure 6b. Human Body Model Current Waveform

Table 1. Test Severity Levels for Communication Lines

LEVEL	ON I/O, SIGNAL, DATA AND CONTROL PORTS	EFT	INDUSTRIAL ELECTRO-MAGNETIC ENVIROMENT
	PEAK VOLTAGE	REPETITION RATE (kHz)	
1	250	5	Well protected
2	500	5	Protected
3	1000	5	Typical
4	2000	5	Severe
X	4000	5	MAX3040-MAX3045

±10kV ESD-Protected, Quad 5V RS-485/RS-422 Transmitters

IEC 1000-4-4 Burst/Electrical Fast Transient Test Levels (For Communication Lines)

The stresses are applied while the MAX3040–MAX3045 are powered up. Test results are reported as:

- 1) Normal performance within the specification limits.
- 2) Temporary degradation or loss of function or performance which is self-recoverable.
- 3) Temporary degradation, loss of function or performance requiring operator intervention, such as system reset.
- 4) Degradation or loss of function not recoverable due to damage.

The MAX3040–MAX3045 meets classification 2 listed above. Additionally, the MAX3040–MAX3045 will not latchup during the IEC burst stress events.

Hot-Swap Capability

Hot-Swap Inputs

When circuit boards are plugged into a “hot” backplane, there can be disturbances to the differential signal levels that could be detected by receivers connected to the transmission line. This erroneous data could cause data errors to an RS-485/RS-422 system. To avoid this, the MAX3040–MAX3045 have hot-swap capable inputs.

When a circuit board is plugged into a “hot” backplane there is an interval during which the processor is going through its power-up sequence. During this time, the processor’s output drivers are high impedance and will be unable to drive the enable inputs of the MAX3040–MAX3045 (EN, $\overline{\text{EN}}$, EN₋) to defined logic levels. Leakage currents from these high impedance drivers, of as much as 10 μA , could cause the enable inputs of the MAX3040–MAX3045 to drift high or low. Additionally, parasitic capacitance of the circuit board could cause capacitive coupling of the enable inputs to either GND or V_{CC}. These factors could cause the enable inputs of the MAX3040–MAX3045 to drift to levels that may enable the transmitter outputs (Y₋ and Z₋). To avoid this problem, the hot-swap input provides a method of holding the enable inputs of the MAX3040–MAX3045 in the disabled state as V_{CC} ramps up. This hot-swap input is able to overcome the leakage currents and parasitic capacitances that may pull the enable inputs to the enabled state.

Hot-Swap Input Circuitry

In the MAX3040–MAX3045 the enable inputs feature hot-swap capability. At the input there are two NMOS

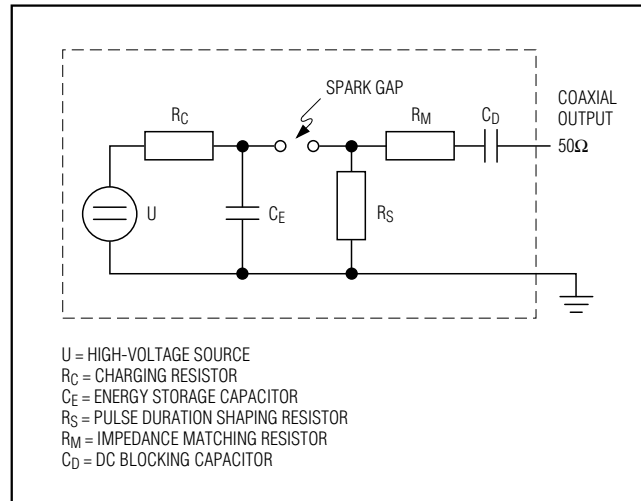

Figure 7. Simplified Circuit Diagram of a Fast Transient/Burst Generator

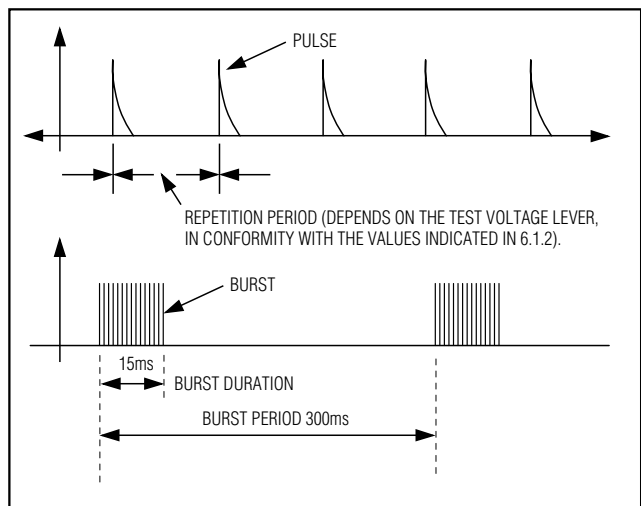

Figure 8. General Graph of a Fast Transient Burst

devices, Q1 and Q2 (Figure 9). When V_{CC} is ramping up from 0, an internal 10 μs timer turns on Q2 and sets the SR latch, which also turns on Q1. Transistors Q2, a 700 μA current sink, and Q1, an 85 μA current sink, pull EN to GND through a 5.6k Ω resistor. Q2 is designed to pull the EN input to the disabled state against an external parasitic capacitance of up to 100pF that is trying to enable the EN input. After 10 μs , the timer turns Q2 off and Q1 remains on, holding the EN input low against three-state output leakages that might enable EN. Q1 remains on until an external source overcomes the

MAX3040–MAX3045

±10kV ESD-Protected, Quad 5V RS-485/RS-422 Transmitters

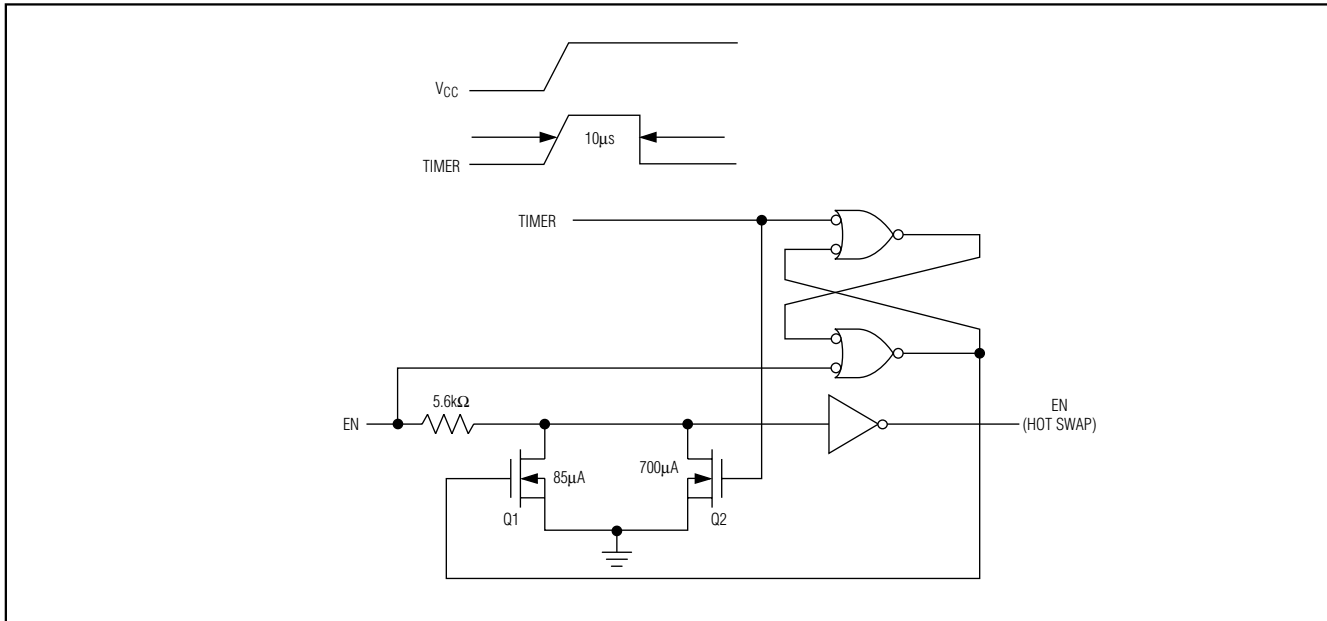

Figure 9. Simplified Structure of the Driver Enable Pin (EN)

required input current. At this time the SR latch resets and Q1 turns off. When Q1 turns off, EN reverts to a standard, high-impedance CMOS input. Whenever V_{CC} drops below 1V, the hot-swap input is reset.

The EN12 and EN34 input structures are identical to the EN input. For the \overline{EN} input, there is a complimentary circuit employing two PMOS devices pulling the \overline{EN} input to V_{CC} .

Hot-Swap Line Transient

The circuit of Figure 10 shows a typical offset termination used to guarantee a greater than 200mV offset when a line is not driven. The 50pF represents the minimum parasitic capacitance which would exist in a typical application. In most cases, more capacitance exists in the system and will reduce the magnitude of the glitch. During a “hot-swap” event when the driver is connected to the line and is powered up, the driver must not cause the differential signal to drop below 200mV. Figures 11 and 12 show the results of the MAX3040–MAX3045 during power-up for two different V_{CC} ramp rates (0.1V/ μ s and 1V/ μ s). The photos show the V_{CC} ramp, the single-ended signal on each side of the 100 Ω termination, the differential signal across the termination, and shows the hot-swap line transient stays above the 200mV RS-485 specification.

Operation of Enable Pins

The MAX3040–MAX3045 family has two enable-functional versions:

The MAX3040/MAX3041/MAX3042B have two transmitter enable inputs EN12 and EN34. EN12 controls the transmitters 1 and 2, and EN34 controls transmitters 3 and 4. EN12 and EN34 are active-high and the part will enter the low-power shutdown mode when both are pulled low. The transmitter outputs are high impedance when disabled (Table 2).

The MAX3043/MAX3044/MAX3045B have two transmitter enable inputs EN and \overline{EN} , which are active-high and active-low, respectively. When EN is logic high or \overline{EN} is logic low all transmitters are active. When EN is pulled low and \overline{EN} is driven high, all transmitters are disabled and the part enters the low-power shutdown mode. The transmitter outputs are high impedance when disabled (Table 3).

Applications Information

Typical Applications

The MAX3040–MAX3045 offer optimum performance when used with the MAX3093E/MAX3095 5V quad receivers or MAX3094E/MAX3096 3V quad differential line receivers. Figure 13 shows a typical RS-485 connection for transmitting and receiving data and Figure 14 shows a typical multi-point connection.

±10kV ESD-Protected, Quad 5V RS-485/RS-422 Transmitters

MAX3040-MAX3045

**Table 2. Function Table for MAX3040/
MAX3041/MAX3042B**
(Each Pair of Transmitters)

INPUT	EN ₋	OUTPUTS	
		Y ₋	Z ₋
H	H	H	L
L	H	L	H
X	L	High-Z	High-Z

*H = Logic High
L = Logic Low
X = Don't Care
High-Z = High Impedance*

**Table 3. Function Table for MAX3043/
MAX3044/MAX3045B**
(All Transmitters)

INPUT	EN	$\overline{\text{EN}}$	OUTPUTS	
			Y	Z
H	H	X	H	L
L	H	X	L	H
H	X	L	H	L
L	X	L	L	H
X	L	H	High-Z	High-Z

*H = Logic High
L = Logic Low
X = Don't Care
High-Z = High Impedance*



Figure 10. Differential Power-Up Glitch (Hot Swap)



Figure 11. Differential Power-Up Glitch (0.1V/μs)

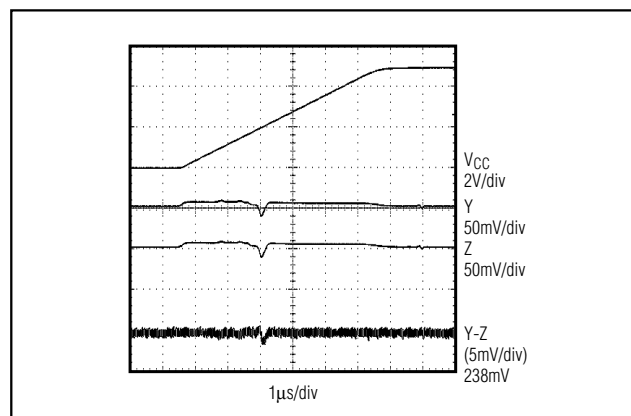

Figure 12. Differential Power-Up Glitch (1V/μs)

±10kV ESD-Protected, Quad 5V RS-485/RS-422 Transmitters



Figure 13. Typical Connection of a Quad Transmitter and a Quad Receiver as a Pair

Typical Multiple-Point Connection

Figure 14 shows a typical multiple-point connection for the MAX3040-MAX3045 with the MAX3095. Because of the high frequencies and the distances involved, high attention must be paid to transmission-line effects while using termination resistors. A terminating resistor (RT) is simply a resistor that should be placed at the extreme ends of the cable to match the characteristic impedance of the cable. When the termination resistance is not the same value as the characteristic

impedance of the cable, reflections will occur as the signal is traveling down the cable. Although some reflections are inevitable due to the cable and resistor tolerances, large mismatches can cause significant reflections resulting in errors in the data. With this in mind, it is very important to match the terminating resistance and the characteristic impedance as closely as possible. As a general rule in a multi-drop system, termination resistors should always be placed at both ends of the cable.

±10kV ESD-Protected, Quad 5V RS-485/RS-422 Transmitters

MAX3040-MAX3045



Figure 12. Typical Connection for Multiple-Point RS-485 Bus

Ordering Information (continued)

PART	TEMP RANGE	PIN-PACKAGE	DATA RATE
MAX3041CUE	0°C to +70°C	16 TSSOP	2.5Mbps
MAX3041CSE	0°C to +70°C	16 Narrow SO	2.5Mbps
MAX3041CWE	0°C to +70°C	16 Wide SO	2.5Mbps
MAX3041EUE	-40°C to +85°C	16 TSSOP	2.5Mbps
MAX3041ESE	-40°C to +85°C	16 Narrow SO	2.5Mbps
MAX3041EWE	-40°C to +85°C	16 Wide SO	2.5Mbps
MAX3042BCUE	0°C to +70°C	16 TSSOP	20Mbps
MAX3042BCSE	0°C to +70°C	16 Narrow SO	20Mbps
MAX3042BCWE	0°C to +70°C	16 Wide SO	20Mbps
MAX3042BEUE	-40°C to +85°C	16 TSSOP	20Mbps
MAX3042BESE	-40°C to +85°C	16 Narrow SO	20Mbps
MAX3042BEWE	-40°C to +85°C	16 Wide SO	20Mbps
MAX3043CUE	0°C to +70°C	16 TSSOP	250kbps
MAX3043CSE	0°C to +70°C	16 Narrow SO	250kbps
MAX3043EWE	0°C to +70°C	16 Wide SO	250kbps
MAX3043EUE	-40°C to +85°C	16 TSSOP	250kbps
MAX3043ESE	-40°C to +85°C	16 Narrow SO	250kbps
MAX3043EWE	-40°C to +85°C	16 Wide SO	250kbps
MAX3044CUE	0°C to +70°C	16 TSSOP	2.5Mbps
MAX3044CSE	0°C to +70°C	16 Narrow SO	2.5Mbps
MAX3044CWE	0°C to +70°C	16 Wide SO	2.5Mbps
MAX3044EUE	-40°C to +85°C	16 TSSOP	2.5Mbps
MAX3044ESE	-40°C to +85°C	16 Narrow SO	2.5Mbps
MAX3044EWE	-40°C to +85°C	16 Wide SO	2.5Mbps

PART	TEMP RANGE	PIN-PACKAGE	DATA RATE
MAX3045BCUE	0°C to +70°C	16 TSSOP	20Mbps
MAX3045BCSE	0°C to +70°C	16 Narrow SO	20Mbps
MAX3045BCWE	0°C to +70°C	16 Wide SO	20Mbps
MAX3045BEUE	-40°C to +85°C	16 TSSOP	20Mbps
MAX3045BESE	-40°C to +85°C	16 Narrow SO	20Mbps
MAX3045BEWE	-40°C to +85°C	16 Wide SO	20Mbps

Pin Configurations (continued)



Chip Information

TRANSISTOR COUNT: 545

PROCESS: CMOS

±10kV ESD-Protected, Quad 5V RS-485/422 Transmitters

Ordering Information (continued)

PART	TEMP. RANGE	PIN-PACKAGE	DATA RATE
MAX3041 CUE	0°C to +70°C	16 TSSOP	2.5Mbps
MAX3041CSE	0°C to +70°C	16 Narrow SO	2.5Mbps
MAX3041CWE	0°C to +70°C	16 Wide SO	2.5Mbps
MAX3041EUE	-40°C to +85°C	16 TSSOP	2.5Mbps
MAX3041ESE	-40°C to +85°C	16 Narrow SO	2.5Mbps
MAX3041EWE	-40°C to +85°C	16 Wide SO	2.5Mbps
MAX3042B CUE	0°C to +70°C	16 TSSOP	20Mbps
MAX3042BCSE	0°C to +70°C	16 Narrow SO	20Mbps
MAX3042BCWE	0°C to +70°C	16 Wide SO	20Mbps
MAX3042BEUE	-40°C to +85°C	16 TSSOP	20Mbps
MAX3042BESE	-40°C to +85°C	16 Narrow SO	20Mbps
MAX3042BEWE	-40°C to +85°C	16 Wide SO	20Mbps
MAX3043 CUE	0°C to +70°C	16 TSSOP	250kbps
MAX3043CSE	0°C to +70°C	16 Narrow SO	250kbps
MAX3043EWE	0°C to +70°C	16 Wide SO	250kbps
MAX3043EUE	-40°C to +85°C	16 TSSOP	250kbps
MAX3043ESE	-40°C to +85°C	16 Narrow SO	250kbps
MAX3043EWE	-40°C to +85°C	16 Wide SO	250kbps

PART	TEMP. RANGE	PIN-PACKAGE	DATA RATE
MAX3044 CUE	0°C to +70°C	16 TSSOP	2.5Mbps
MAX3044CSE	0°C to +70°C	16 Narrow SO	2.5Mbps
MAX3044CWE	0°C to +70°C	16 Wide SO	2.5Mbps
MAX3044EUE	-40°C to +85°C	16 TSSOP	2.5Mbps
MAX3044ESE	-40°C to +85°C	16 Narrow SO	2.5Mbps
MAX3044EWE	-40°C to +85°C	16 Wide SO	2.5Mbps
MAX3045B CUE	0°C to +70°C	16 TSSOP	20Mbps
MAX3045BCSE	0°C to +70°C	16 Narrow SO	20Mbps
MAX3045BCWE	0°C to +70°C	16 Wide SO	20Mbps
MAX3045BEUE	-40°C to +85°C	16 TSSOP	20Mbps
MAX3045BESE	-40°C to +85°C	16 Narrow SO	20Mbps
MAX3045BEWE	-40°C to +85°C	16 Wide SO	20Mbps

Pin Configurations (continued)



±10kV ESD-Protected, Quad 5V RS-485/RS-422 Transmitters

Package Information (continued)

MAX3040-MAX3045



	INCHES		MILLIMETERS	
	MIN	MAX	MIN	MAX
A	0.093	0.104	2.35	2.65
A1	0.004	0.012	0.10	0.30
B	0.014	0.019	0.35	0.49
C	0.009	0.013	0.23	0.32
e	0.050		1.27	
E	0.291	0.299	7.40	7.60
H	0.394	0.419	10.00	10.65
h	0.010	0.030	0.25	0.75
L	0.016	0.050	0.40	1.27

	INCHES		MILLIMETERS			
	MIN	MAX	MIN	MAX	N	MS013
D	0.398	0.413	10.10	10.50	16	AA
D	0.447	0.463	11.35	11.75	18	AB
D	0.496	0.512	12.60	13.00	20	AC
D	0.598	0.614	15.20	15.60	24	AD
D	0.697	0.713	17.70	18.10	28	AE

NOTES:

1. D&E DO NOT INCLUDE MOLD FLASH
2. MOLD FLASH OR PROTRUSIONS NOT TO EXCEED .15mm (.006")
3. LEADS TO BE COPLANAR WITHIN .102mm (.004")
4. CONTROLLING DIMENSION: MILLIMETER
5. MEETS JEDEC MS013-XX AS SHOWN IN ABOVE TABLE
6. N = NUMBER OF PINS

 <small>120 SAN GABRIEL DR. SUNNYVALE CA 94086 FAX (408) 737-7194</small> <small>PROPRIETARY INFORMATION</small>	PACKAGE FAMILY OUTLINE: SOIC .300"		21-0042 A
			<small>DOCUMENT CONTROL NUMBER REV</small>

Maxim cannot assume responsibility for use of any circuitry other than circuitry entirely embodied in a Maxim product. No circuit patent licenses are implied. Maxim reserves the right to change the circuitry and specifications without notice at any time.

Maxim Integrated Products, 120 San Gabriel Drive, Sunnyvale, CA 94086 408-737-7600 _____ 15

Looking for pricing, stock, or lifecycle information?

Click below to explore more details on WIN SOURCE:

- ⊖ [View MAX3041EWE+ on WIN SOURCE](#)
- ⊖ [Maxim Integrated Information](#)

Optimize Your Supply Chain with WIN SOURCE Solutions

- ✓ Global Sourcing Solution
- ✓ Obsolete Management
- ✓ Cost Control Management
- ✓ Shortage Management
- ✓ Alternative Solution
- ✓ Excess Inventory Management