



**THE DATASHEET OF
MAX2839ASEWO+W**





2.3GHz to 2.7GHz MIMO Wireless Broadband RF Transceiver

MAX2839AS

General Description

The MAX2839AS direct conversion, zero-IF, RF transceiver is designed specifically for 2.3GHz to 2.7GHz 802.16e MIMO mobile WiMAX™ systems. The device incorporates one transmitter and two receivers, with > 40dB isolation between each receiver. The MAX2839AS completely integrates all circuitry required to implement the RF transceiver function, providing RF to baseband receive path, and baseband to RF transmit path, VCO, frequency synthesizer, crystal oscillator, and baseband/control interface. The device includes a fast-settling sigma-delta RF synthesizer with smaller than 40Hz frequency steps and a crystal oscillator that allows the use of a low-cost crystal in place of a TCXO. The transceiver IC also integrates circuits for on-chip DC-offset cancellation, I/Q error, and carrier leakage detection circuits. An internal transmit to receive loopback mode allows for receiver I/Q imbalance calibration. The local oscillator I/Q quadrature phase error can be digitally corrected in approximately 0.125° steps. Only an RF bandpass filter (BPF), crystal, RF switch, PA, and a small number of passive components are needed to form a complete wireless broadband RF radio solution.

The MAX2839AS completely eliminates the need for an external SAW filter by implementing on-chip programmable monolithic filters for both the receiver and transmitter, for all 2GHz and 802.16e profiles and WiBro. The baseband filters along with the Rx and Tx signal paths are optimized to meet the stringent noise figure and linearity specifications. The device supports up to 2048 FFT OFDM and implements programmable channel filters for 3.5MHz to 20MHz RF channel bandwidths. The transceiver requires only 2μs Tx-Rx switching time. The IC is available in a small wafer-level package (WLP) measuring 5.16mm x 3.66mm x 0.5mm.

Applications

802.16e Mobile WiMAX Systems
Korean WiBro Systems
Proprietary Wireless Broadband Systems
802.11g or n WLAN with MRC or MIMO Down Link

WiMAX is a trademark of the WiMAX Forum.

SPI is a trademark of Motorola, Inc.

Features

- ◆ 2.3GHz to 2.7GHz Wideband Operation
- ◆ Dual Receivers for MIMO, Single Transmitter
- ◆ Complete RF Transceiver, PA Driver, and Crystal Oscillator
 - 3.5dB Rx Noise Figure on Each Receiver with Balun
 - 35dB Rx EVM for 64QAM Signal
 - 0dBm Linear OFDM Transmit Power (64QAM)
 - 70dB Tx Spectral Emission Mask
 - 35dBc LO Leakage
 - Automatic Rx DC Offset Correction
 - Monolithic Low-Noise VCO with -39dBc Integrated Phase Noise
 - Programmable Rx I/Q Lowpass Channel Filters
 - Programmable Tx I/Q Lowpass Anti-Aliasing Filters
 - Sigma-Delta Fractional-N PLL with 28.61Hz Minimum Step Size
 - 62dB Tx Gain Control Range with 1dB Step Size, Digitally Controlled
 - 95dB Rx Gain Control Range with 1dB Step Size, Digitally Controlled
 - 60dB Analog RSSI Instantaneous Dynamic Range
 - 4-Wire SPI™ Digital Interface
 - I/Q Analog Baseband Interface
 - Digital Tx/Rx Mode Control
 - Digitally Tuned Crystal Oscillator
 - On-Chip Digital Temperature Sensor Readout
- ◆ +2.7V to +3.6V Transceiver Supply
- ◆ Low-Power Shutdown Current
- ◆ Small WLP Package (5.16mm x 3.66mm x 0.5mm)

Ordering Information

PART	TEMP RANGE	PIN-PACKAGE
MAX2839ASEWO+T	-40°C to +85°C	73 WLP

+ Denotes a lead(Pb)-free/RoHS-compliant package.
T = Tape and reel.

Bump Configuration and Typical Operating Circuit appear at end of data sheet.



2.3GHz to 2.7GHz MIMO Wireless Broadband RF Transceiver

ABSOLUTE MAXIMUM RATINGS

V_{CC_} Pins to GND.....-0.3V to +3.9V
 RF Inputs: RXINA+, RXINA-, RXINB+,
 RXINB- to GNDAC-Coupled Only
 RF Outputs: TXOUT+, TXOUT- to GND.....-0.3V to +3.9V
 Analog Inputs: TXBBI+, TXBBI-, TXBBQ+,
 TXBBQ- to GND.....-0.3V to +3.9V
 Analog Input: REFCLK, XTAL1-0.3V to +3.9V_{P-P}
 Analog Outputs: RXBBIA+, RXBBIA-, RXBBQA+, RXBBQA-,
 RXBBIB+, RXBBIB-, RXBBQB+, RXBBQB-, CPOUT+,
 CPOUT-, PABIAS, RSSI to GND.....-0.3V to +3.9V
 Digital Inputs: TXRX, \overline{CS} , SCLK, DIN, B7:B0,
 CLKOUT_DIV, RXHP, ENABLE to GND-0.3V to +3.9V

Digital Outputs: DOUT, CLKOUT-0.3V to +3.9V
 Bias Voltages: VCOBYP-0.3V to +3.9V
 Short-Circuit Duration on All Output Pins10s
 RF Input Power: All RXIN_+10dBm
 RF Output Differential Load VSWR: All TXOUT6:1
 Continuous Power Dissipation (T_A = +70°C)
 73-Bump WLP (derate 31.3mW/°C above +70°C).....2500mW
 Operating Temperature Range-40°C to +85°C
 Junction Temperature+150°C
 Storage Temperature Range-65°C to +160°C
 Soldering Temperature (reflow)(Note 1) +260°C

Note 1: Refer to Application Note 1891: *Understanding the Basics of the Wafer-Level Chip-Scale Package (WL-CSP)* available at www.maxim-ic.com.

Stresses beyond those listed under "Absolute Maximum Ratings" may cause permanent damage to the device. These are stress ratings only, and functional operation of the device at these or any other conditions beyond those indicated in the operational sections of the specifications is not implied. Exposure to absolute maximum rating conditions for extended periods may affect device reliability.

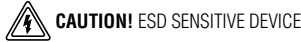

DC ELECTRICAL CHARACTERISTICS

(MAX2839AS Evaluation Kit. Unless otherwise noted, V_{CC_} = 2.7V to 3.6V, T_A = -40°C to +85°C, Rx set to the maximum gain. ENABLE and TXRX set according to operating mode. \overline{CS} = high, SCLK = DIN = low, no input signal at RF inputs, all RF inputs and outputs terminated into 50Ω. 90mV_{RMS} differential I and Q signals (1MHz) applied to I, Q baseband inputs of transmitter in transmit mode, all registers set to recommended settings. Typical values are at V_{CC_} = 2.8V, f_{LO} = 2.5GHz, and T_A = +25°C.) (Note 2)

PARAMETER	CONDITIONS	MIN	TYP	MAX	UNITS	
Supply Voltage	V _{CC_}	2.7		3.6	V	
Supply Current	Shutdown mode, T _A = +25°C; all logic inputs equal 0 or V _{CC}		2		μA	
	Clock-out only mode		2.7	3.8	mA	
	Standby mode		33	50		
	Rx mode	One receiver on		79		101
		Both receivers on		120		148
	Tx mode	16 QAM		116		148
		64 QAM (Note 3)		145		183
	Rx calibration mode, both receivers on		153	200		
	Tx calibration mode		102	145		
Rx I/Q Output Common-Mode Voltage	D[9:8] = 00 in A[4:0] = 00100	0.8	1.05	1.35	V	
	D[9:8] = 01 in A[4:0] = 00100		1.15			
	D[9:8] = 10 in A[4:0] = 00100		1.25			
	D[9:8] = 11 in A[4:0] = 00100		1.45			
Tx Baseband Input Common-Mode Voltage Operating Range	DC-coupled	0.5		1.2	V	
Tx Baseband Input Bias Current	Source current		10	20	μA	
LOGIC INPUTS: TXRX, ENABLE, SCLK, DIN, \overline{CS}, B7:B0, CLKOUT_DIV, RXHP						
Digital Input-Voltage High, V _{IH}		V _{CC} - 0.4			V	
Digital Input-Voltage Low, V _{IL}				0.4	V	
Digital Input-Current High, I _{IH}		-1		+1	μA	

2.3GHz to 2.7GHz MIMO Wireless Broadband RF Transceiver

MAX2839AS

DC ELECTRICAL CHARACTERISTICS (continued)

(MAX2839AS Evaluation Kit. Unless otherwise noted, $V_{CC-} = 2.7V$ to $3.6V$, $T_A = -40^{\circ}C$ to $+85^{\circ}C$, Rx set to the maximum gain. ENABLE and TXRX set according to operating mode. $\overline{CS} = \text{high}$, SCLK = DIN = low, no input signal at RF inputs, all RF inputs and outputs terminated into 50Ω . $90mV_{RMS}$ differential I and Q signals (1MHz) applied to I, Q baseband inputs of transmitter in transmit mode, all registers set to recommended settings. Typical values are at $V_{CC-} = 2.8V$, $f_{LO} = 2.5GHz$, and $T_A = +25^{\circ}C$.) (Note 2)

PARAMETER	CONDITIONS	MIN	TYP	MAX	UNITS
Digital Input-Current Low, I_{IL}		-1		+1	μA
LOGIC OUTPUTS: DOUT, CLKOUT					
Digital Output-Voltage High, V_{OH}	Sourcing $100\mu A$	$V_{CC} - 0.4$			V
Digital Output-Voltage Low, V_{OL}	Sinking $100\mu A$	0.4			V

AC ELECTRICAL CHARACTERISTICS—Rx MODE

(MAX2839AS Evaluation Kit. Unless otherwise noted, $V_{CC-} = 2.8V$, $T_A = +25^{\circ}C$, $f_{RF} = 2.4999GHz$, $f_{LO} = 2.5GHz$; baseband output signal frequency = $100kHz$, $f_{REF} = 40MHz$, ENABLE = TXRX = $\overline{CS} = \text{high}$, SCLK = DIN = low, with power matching for the differential RF pins using the *Typical Operating Circuit* and registers set to default settings. Lowpass filter is set to 10MHz RF channel BW. Unmodulated single-tone RF input signal is used.) (Note 2)

PARAMETER	CONDITIONS	MIN	TYP	MAX	UNITS
RF INPUT TO I, Q BASEBAND-LOADED OUTPUT					
RF Input Frequency Range		2.3		2.7	GHz
Peak-to-Peak Gain Variation over RF Input Frequency Range	Tested at band edges and band center		1.5		dB
RF Input Return Loss	All LNA settings		12		dB
Total Voltage Gain	$T_A = -40^{\circ}C$ to $+85^{\circ}C$	Maximum gain, B7:B0 = 0000000	92	99	dB
		Minimum gain, B7:B0 = 1111111	4	10	
RF Gain Steps	From max RF gain (B7:B6 = 00) to max RF gain - 8dB (B7:B6 = 01)		8		dB
	From max RF gain to max RF gain - 16dB (B7:B6 = 10)		16		
	From max RF gain to max RF gain - 32dB (B7:B6 = 11)		32		
Gain Change Settling Time	Any RF or baseband gain change; gain settling to within $\pm 1dB$ of steady state; RXHP = 1		200		ns
	Any RF or baseband gain change; gain settling to within $\pm 0.1dB$ of steady state; RXHP = 1		2000		
Baseband Gain Range	From maximum baseband gain (B5:B0 = 000000) to minimum gain (B5:B0 = 111111), $T_A = -40^{\circ}C$ to $+85^{\circ}C$	60.5	63	65.5	dB
Baseband Gain Step Size			1		dB
DSB Noise Figure (Including Balun Loss)	Voltage gain = 65dB with max RF gain (B7:B6 = 00)		3.5		dB
	Voltage gain = 50dB with max RF gain - 8dB (B7:B6 = 01)		8.5		
	Voltage gain = 45dB with max RF gain - 16dB (B7:B6 = 10)		14.5		
	Voltage gain = 15dB with max RF gain - 32dB (B7:B6 = 11)		32		

2.3GHz to 2.7GHz MIMO Wireless Broadband RF Transceiver

AC ELECTRICAL CHARACTERISTICS—Rx MODE (continued)

(MAX2839AS Evaluation Kit. Unless otherwise noted, $V_{CC} = 2.8V$, $T_A = +25^\circ C$, $f_{RF} = 2.4999GHz$, $f_{LO} = 2.5GHz$; baseband output signal frequency = 100kHz, $f_{REF} = 40MHz$, $ENABLE = TXRX = \overline{CS} = high$, $SCLK = DIN = low$, with power matching for the differential RF pins using the *Typical Operating Circuit* and registers set to default settings. Lowpass filter is set to 10MHz RF channel BW. Unmodulated single-tone RF input signal is used.) (Note 2)

PARAMETER	CONDITIONS	MIN	TYP	MAX	UNITS
Out-of-Band Input IP3 (Note 4)	AGC set for -65dBm wanted signal, max RF gain (B7:B6 = 00)		-13		dBm
	AGC set for -55dBm wanted signal, max RF gain - 8dB (B7:B6 = 01)		-9		
	AGC set for -40dBm wanted signal, max RF gain - 16dB (B7:B6 = 10)		-7		
	AGC set for -30dBm wanted signal, max RF gain - 32dB (B7:B6 = 11)		+16		
Inband Input P-1dB	Max RF gain (B7:B6 = 00)		-37		dBm
	Max RF gain - 8dB (B7:B6 = 01)		-29		
	Max RF gain - 16dB (B7:B6 = 01)		-21		
	Max RF gain - 32dB (B7:B6 = 11)		-4		
Maximum Output Signal Level	Over passband frequency range at VGA gain between max and max - 54dB; 1dB compression point		1.15		V _{P-P}
I/Q Gain Imbalance	100kHz IQ baseband output; 1 σ variation		0.05		dB
I/Q Phase Error	100kHz IQ baseband output; 1 σ variation		0.25		Degrees
Rx I/Q Output Load Impedance (R C)	Minimum differential resistance	10			k Ω
	Maximum differential capacitance			5	pF
Loopback Gain (for Receiver I/Q Calibration)	Transmitter I/Q input to receiver I/Q output; transmitter B6:B1 = 000011, receiver B5:B0 = 101010 programmed through SPI	-6	-1	+4.5	dB
I/Q Output DC Droop	After switching RXHP to 0; average over 1 μ s after any gain change, or 2 μ s after receive enabled with 100Hz AC-coupling		1		V/s
I/Q Static DC Offset	No RF input signal; measure at 3 μ s after receive enable; RXHP = 1 for 0 to 2 μ s and set to 0 after 2 μ s, 1 σ variation		1		mV
Isolation Between Rx Channels A and B	Any RF gain settings		40		dB
RECEIVER BASEBAND FILTERS					
Baseband Filter Rejection	At 15MHz		57		dB
	At 20MHz		75		
	At > 40MHz		75		
Baseband Highpass Filter Corner Frequency	RXHP = 1 (used before AGC completion)		650		kHz
	RXHP = 0 (used after AGC completion) address A[4:0] = 01110	D[5:4] = 00	0.1		
		D[5:4] = 01	1		
		D[5:4] = 10	30		
	D[5:4] = 11	100			

2.3GHz to 2.7GHz MIMO Wireless Broadband RF Transceiver

MAX2839AS

AC ELECTRICAL CHARACTERISTICS—Rx MODE (continued)

(MAX2839AS Evaluation Kit. Unless otherwise noted, $V_{CC} = 2.8V$, $T_A = +25^{\circ}C$, $f_{RF} = 2.4999GHz$, $f_{LO} = 2.5GHz$; baseband output signal frequency = 100kHz, $f_{REF} = 40MHz$, $ENABLE = TXRX = \overline{CS} = high$, $SCLK = DIN = low$, with power matching for the differential RF pins using the *Typical Operating Circuit* and registers set to default settings. Lowpass filter is set to 10MHz RF channel BW. Unmodulated single-tone RF input signal is used.) (Note 2)

PARAMETER	CONDITIONS	MIN	TYP	MAX	UNITS
RF Channel BW Supported by Baseband Filter	A[4:0] = 00100 serial bits D[9:6] = 0000		1.75		MHz
	A[4:0] = 00100 serial bits D[9:6] = 0001		2.25		
	A[4:0] = 00100 serial bits D[9:6] = 0010		3.5		
	A[4:0] = 00100 serial bits D[9:6] = 0011		5.0		
	A[4:0] = 00100 serial bits D[9:6] = 0100		5.5		
	A[4:0] = 00100 serial bits D[9:6] = 0101		6.0		
	A[4:0] = 00100 serial bits D[9:6] = 0110		7.0		
	A[4:0] = 00100 serial bits D[9:6] = 0111		8.0		
	A[4:0] = 00100 serial bits D[9:6] = 1000		9.0		
	A[4:0] = 00100 serial bits D[9:6] = 1001		10.0		
	A[4:0] = 00100 serial bits D[9:6] = 1010		12.0		
	A[4:0] = 00100 serial bits D[9:6] = 1011		14.0		
	A[4:0] = 00100 serial bits D[9:6] = 1100		15.0		
	A[4:0] = 00100 serial bits D[9:6] = 1101		20.0		
	A[4:0] = 00100 serial bits D[9:6] = 1110		24.0		
A[4:0] = 00100 serial bits D[9:6] = 1111		28.0			
Baseband Gain Ripple	0 to 2.3MHz for RF BW = 5MHz		1.3		dBp-p
	0 to 4.6MHz for RF BW = 10MHz		1.3		
Baseband Group Delay Ripple	0 to 2.3MHz for RF BW = 5MHz		90		nsp-p
	0 to 4.6MHz for RF BW = 10MHz		50		
Baseband Filter Rejection for 5MHz RF Channel BW	At 2.3MHz		1.8		dB
	At > 8.75MHz		75		
Baseband Filter Rejection for 10MHz RF Channel BW	At 4.6MHz		1.6		dB
	At > 17.5MHz		75		
RSSI					
RSSI Minimum Output Voltage	$R_{LOAD} \geq 10k\Omega$		0.6		V
RSSI Maximum Output Voltage	$R_{LOAD} \geq 10k\Omega$		2.1		V
RSSI Slope			29		mV/dB
RSSI Output Settling Time	To within 3dB of steady state	+32dB signal step	200		ns
		-32dB signal step	800		

2.3GHz to 2.7GHz MIMO Wireless Broadband RF Transceiver

AC ELECTRICAL CHARACTERISTICS—Tx MODE

(MAX2839AS Evaluation Kit. Unless otherwise noted, $V_{CC-} = 2.8V$, $T_A = +25^{\circ}C$, $f_{RF} = 2.501GHz$, $f_{LO} = 2.5GHz$, $f_{REF} = 40MHz$, $ENABLE = \overline{CS} = high$, $TXRX = SCLK = DIN = low$, with power matching for the differential RF pins using the *Typical Operating Circuit* and registers set to default settings. Lowpass filter is set to 10MHz RF channel BW. 1MHz 90mV_{RMS} cosine and sine signals applied to I/Q baseband inputs of transmitter (differential DC-coupled)). (Note 2)

PARAMETER	CONDITIONS	MIN	TYP	MAX	UNITS
Tx BASEBAND I/Q INPUTS TO RF OUTPUTS					
RF Output Frequency Range		2.3		2.7	GHz
Peak-to-Peak Peak Gain Variation over RF Band			1	2	dB
Total Voltage Gain	Max gain - 3dB; at unbalanced 50Ω matched output	3.5	8		dB
Max Output Power over Frequency	64 QAM OFDM signal conforming to spectral emission mask and -36dB EVM after I/Q imbalance calibration by modem (Note 5)		0		dBm
RF Output Return Loss			8		dB
RF Gain Control Range	B6:B1 = 000000 to 111111		62		dB
Unwanted Sideband Suppression	Without calibration by modem, and excludes modem I/Q imbalance; $P_{OUT} = 0dBm$		40		dB
RF Gain Control Binary Weights	B1		1		dB
	B2		2		
	B3		4		
	B4		8		
	B5		16		
	B6		32		
Carrier Leakage	Relative to 0dBm output power; without calibration by modem		-30		dBc
Tx I/Q Input Impedance (RIIC)	Differential resistance		100		kΩ
	Differential capacitance		0.5		pF
Baseband Frequency Response for 5MHz RF Channel BW	0 to 3.333MHz		0.9		dB
	At > 9.45MHz		43		
Baseband Frequency Response for 10MHz RF Channel BW	0 to 6.667MHz		0.9		dB
	At > 18.9MHz		43		
Baseband Group Delay Ripple	0 to 3.333MHz (RF BW = 5MHz)		20		ns
	0 to 6.667MHz (RF BW = 10MHz)		12		

2.3GHz to 2.7GHz MIMO Wireless Broadband RF Transceiver

MAX2839AS

AC ELECTRICAL CHARACTERISTICS—FREQUENCY SYNTHESIS

(MAX2839AS Evaluation Kit. Unless otherwise noted, $V_{CC-} = 2.8V$, $T_A = +25^{\circ}C$, $f_{LO} = 2.5GHz$, $f_{REF} = 40MHz$, $\overline{CS} = high$, $SCLK = DIN = low$, PLL closed-loop unity gain bandwidth = 120kHz. VCO and RF synthesis enabled.) (Note 2)

PARAMETER	CONDITIONS	MIN	TYP	MAX	UNITS
RF Channel Center Frequency Range		2.3		2.7	GHz
Channel Center Frequency Programming Minimum Step Size			28.61		Hz
Charge-Pump Comparison Frequency			40		MHz
Reference Frequency Range		15	40	80	MHz
Reference Frequency Input Levels	AC-coupled to REFCLK pin	0.6			V _{P-P}
Reference Frequency Input Impedance (RIIC)	Resistance (REFCLK pin)		10		k Ω
	Capacitance (REFCLK pin)		1		pF
Programmable Reference Divider Values		1	2	4	
Closed-Loop Integrated Phase Noise	Integrate phase noise from 200Hz to 5MHz; charge-pump comparison frequency = 40MHz		-39		dBc
Charge-Pump Output Current	On each differential side		0.8		mA
Close-In Spur Level	$f_{OFFSET} = 0$ to 1.8MHz		-40		dBc
	$f_{OFFSET} = 1.8MHz$ to 7MHz		-70		
	$f_{OFFSET} > 7MHz$		-80		
Reference Spur Level			-85		dBc
Turnaround LO Frequency Error	Relative to steady state; measured 35 μ s after Tx-Rx or Rx-Tx switching instant, and 4 μ s after any receiver gain changes		± 50		Hz
Temperature Range Over Which VCO Maintains Lock	Relative to the ambient temperature T_A at initial lock		$T_A \pm 40$		$^{\circ}C$
Reference Output Clock Divider Values	CLKOUT_DIV pin = 0		1		
	CLKOUT_DIV pin = 1		2		
Output Clock Drive Level	20MHz output, A[4:0] = 10100, D5 = 0		2.4		V _{P-P}
Output Clock Load Impedance (RIIC)	Resistance		10		k Ω
	Capacitance		2		pF

2.3GHz to 2.7GHz MIMO Wireless Broadband RF Transceiver

AC ELECTRICAL CHARACTERISTICS—MISCELLANEOUS BLOCKS

(MAX2839AS Evaluation Kit. Unless otherwise noted, $V_{CC_} = 2.8V$, $f_{REF} = 40MHz$, $\overline{CS} = high$, $SCLK = DIN = low$, and $T_A = +25^\circ C$.) (Note

PARAMETER	CONDITIONS	MIN	TYP	MAX	UNITS
PA BIAS DAC: VOLTAGE MODE					
Output High level	10mA source current		$V_{CC} - 0.1$		V
Output Low level	100 μ A sink current		0.1		V
Turn-On Time	Excludes programmable delay of 0 to 7 μ s in steps of 0.5 μ s		200		ns
CRYSTAL OSCILLATOR					
On-Chip Tuning Capacitance Range	Maximum capacitance, A[4:0] = 11000, D[6:0] = 1111111		15.5		pF
	Minimum capacitance, A[4:0] = 11000, D[6:0] = 0000000		0.5		
On-Chip Tuning Capacitance Step Size			0.12		pF
ON-CHIP TEMPERATURE SENSOR					
Digital Output Code	Readout at DOUT pin through SPI A[4:0] = 01011, D[4:0]	$T_A = +25^\circ C$	01111		
		$T_A = +85^\circ C$	11101		
		$T_A = -40^\circ C$	00001		

AC ELECTRICAL CHARACTERISTICS—TIMING

(MAX2839AS Evaluation Kit. Unless otherwise noted, $V_{CC_} = 2.8V$, $f_{LO} = 2.5GHz$, $f_{REF} = 40MHz$, $\overline{CS} = high$, $SCLK = DIN = low$, PLL closed-loop unity gain bandwidth = 120kHz, and $T_A = +25^\circ C$.) (Note 2)

PARAMETER	SYMBOL	CONDITIONS	MIN	TYP	MAX	UNITS
SYSTEM TIMING						
Turnaround Time		Measured from Tx or Rx enable edge; signal settling to within 2dB of steady state	Rx to Tx	2		μ s
			Tx to Rx, RXHP = 1	2		
Tx Turn-On Time (from Standby Mode)		Measured from Tx-enable edge; signal settling to within 2dB of steady state		2		μ s
Tx Turn-Off Time (to Standby Mode)		From Tx-disable edge		0.1		μ s
Rx Turn-On Time (from Standby Mode)		Measured from Rx-enable edge; signal settling to within 2dB of steady state		2		μ s
Rx Turn-Off Time (to Standby Mode)		From Rx-disable edge		0.1		μ s

2.3GHz to 2.7GHz MIMO Wireless Broadband RF Transceiver

MAX2839AS

AC ELECTRICAL CHARACTERISTICS—TIMING (continued)

(MAX2839AS Evaluation Kit. Unless otherwise noted, $V_{CC} = 2.8V$, $f_{LO} = 2.5GHz$, $f_{REF} = 40MHz$, $\overline{CS} = high$, $SCLK = DIN = low$, PLL closed-loop unity gain bandwidth = 120kHz, and $T_A = +25^\circ C$.) (Note 2)

PARAMETER	SYMBOL	CONDITIONS	MIN	TYP	MAX	UNITS
4-WIRE SERIAL PARALLEL INTERFACE TIMING (see Figure 1)						
SCLK Rising Edge to \overline{CS} Falling Edge Wait Time	t_{CSO}			6		ns
Falling Edge of \overline{CS} to Rising Edge of First SCLK Time	t_{CSS}			6		ns
DIN to SCLK Setup Time	t_{DS}			6		ns
DIN to SCLK Hold Time	t_{DH}			6		ns
SCLK Pulse-Width High	t_{CH}			6		ns
SCLK Pulse-Width Low	t_{CL}			6		ns
Last Rising Edge of SCLK to Rising Edge of \overline{CS} or Clock to Load Enable Setup Time	t_{CSH}			6		ns
\overline{CS} High Pulse Width	t_{CSW}			20		ns
Time Between Rising Edge of \overline{CS} and the Next Rising Edge of SCLK	t_{CS1}			6		ns
Clock Frequency	f_{CLK}			40		MHz
Rise Time	t_R			$0.1/f_{CLK}$		ns
Fall Time	t_F			$0.1/f_{CLK}$		ns
SCLK Falling Edge to Valid DOUT	t_D			12.5		ns

Note 2: Min/max limits are production tested at $T_A = +85^\circ C$. Min/max limits at $T_A = -40^\circ C$ and $T_A = +25^\circ C$ are guaranteed by design and characterization. The power-on default register settings are not production tested. Load register setting 10 μs after V_{CC} is applied.

Note 3: Tx mode supply current is specified for 64 QAM while achieving the Tx output spectrum mask shown in the *Typical Operating Characteristics*. The supply current can be reduced for 16 QAM signal by adjusting the Tx bias settings through the SPI.

Note 4: Two tones at +20MHz and +39MHz offset with -35dBm/tone. Measure IM3 at 1MHz.

Note 5: Gain adjusted over max gain and max gain -3dB.

2.3GHz to 2.7GHz MIMO Wireless Broadband RF Transceiver

Typical Operating Characteristics

($V_{CC_} = 2.8V$, $T_A = +25^\circ C$, $f_{LO} = 2.5GHz$, $f_{REF} = 40MHz$, $\overline{CS} = high$, $RXHP = SCLK = DIN = low$, $RF BW = 10MHz$, Tx output at 50Ω unbalanced output of balun, using the MAX2839AS Evaluation Kit.)

SINGLE Rx SUPPLY CURRENT vs. SUPPLY VOLTAGE

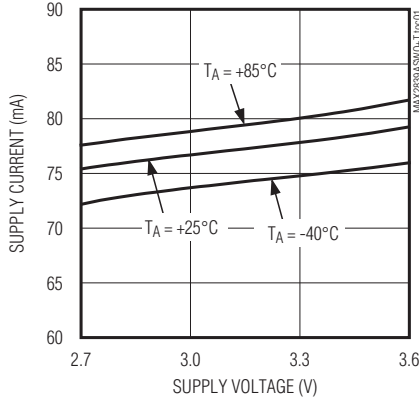

DUAL Rx SUPPLY CURRENT vs. SUPPLY VOLTAGE

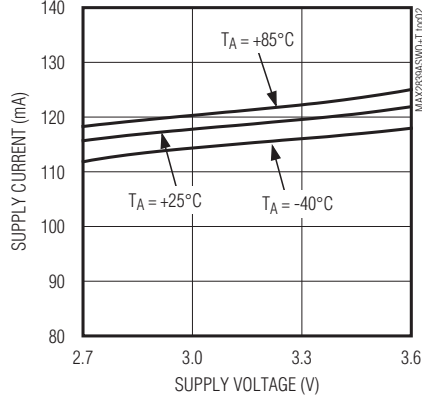

Rx NOISE FIGURE vs. BASEBAND GAIN SETTING

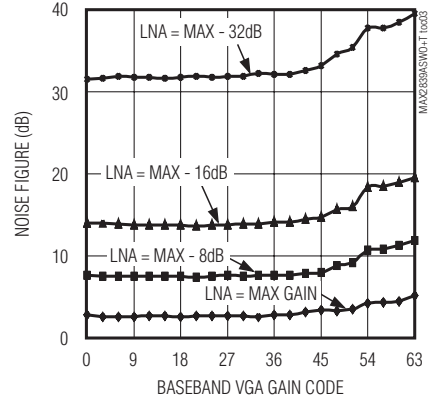

Rx GAIN vs. FREQUENCY

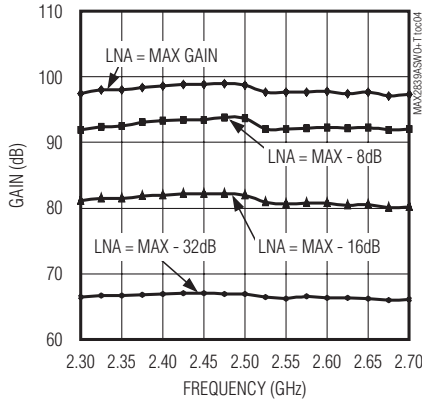

Rx MAX GAIN vs. TEMPERATURE AND FREQUENCY

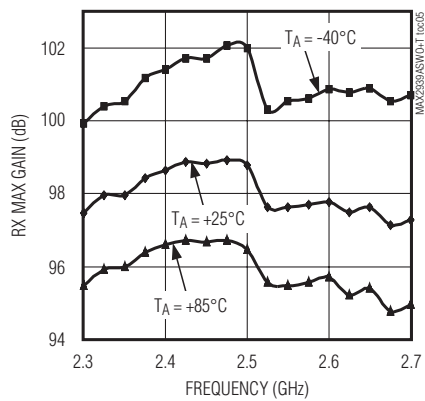

Rx VOLTAGE GAIN vs. BASEBAND GAIN SETTING

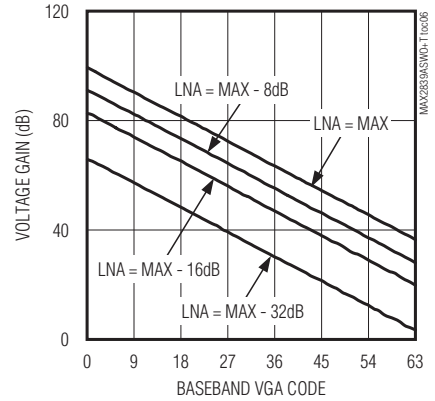

Rx OUTPUT V1dB vs. GAIN SETTING

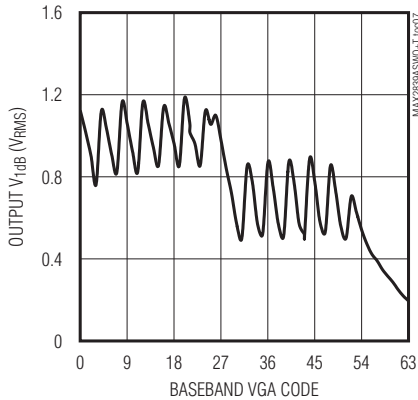

RX_B TO RX_A ISOLATION vs. LNA GAIN SETTING

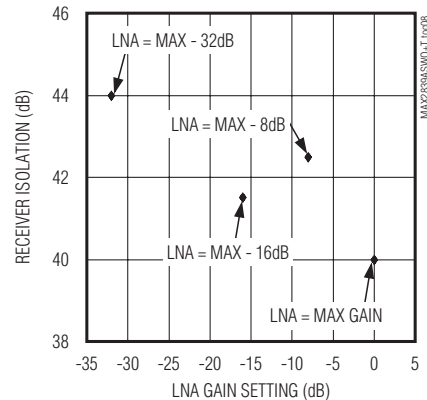

2.3GHz to 2.7GHz MIMO Wireless Broadband RF Transceiver

MAX2839AS

Typical Operating Characteristics (continued)

($V_{CC_2} = 2.8V$, $T_A = +25^\circ C$, $f_{LO} = 2.5GHz$, $f_{REF} = 40MHz$, $\overline{CS} = high$, $RXHP = SCLK = DIN = low$, RF BW = 10MHz, Tx output at 50Ω unbalanced output of balun, using the MAX2839AS Evaluation Kit.)

Rx EVM vs. P_{IN}
(CHANNEL BANDWIDTH = 10MHz,
64 QAM FUSC)

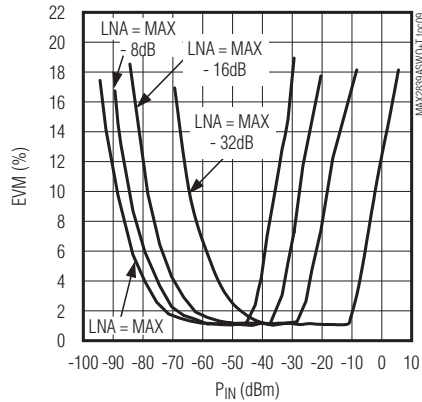

Rx EVM vs. V_{OUT}
(CHANNEL BANDWIDTH = 10MHz,
64 QAM FUSC)

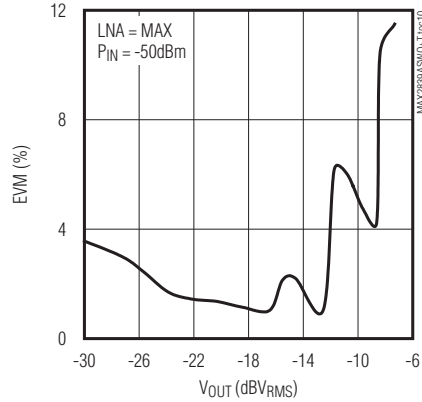

WiMAX EVM vs. OFDM JAMMER
(10MHz CHANNEL BANDWIDTH, 64 QAM FUSC)
 $P_{WANTED} = P_{SENSITIVITY} + 3dB = -70.3dBm$ AT ANTENNA
(INCLUDING 4dB FRONT-END LOSS),
EVM AT $P_{SENSITIVITY} = 6.37%$, WITHOUT JAMMER

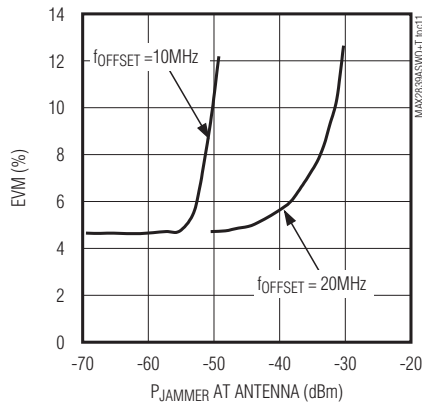

Rx EMISSION SPECTRUM AT LNA INPUT
(LNA = MAX GAIN)

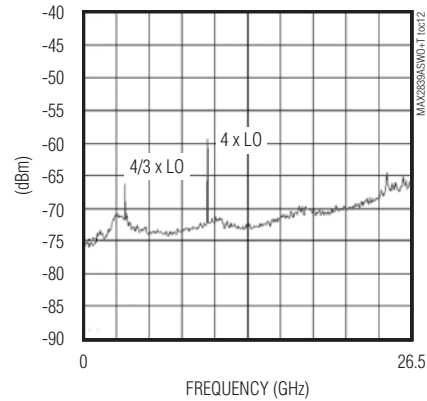

2.3GHz to 2.7GHz MIMO Wireless Broadband RF Transceiver

Typical Operating Characteristics (continued)

($V_{CC_2} = 2.8V$, $T_A = +25^\circ C$, $f_{LO} = 2.5GHz$, $f_{REF} = 40MHz$, $\overline{CS} = high$, $RXHP = SCLK = DIN = low$, RF BW = 10MHz, Tx output at 50 Ω unbalanced output of balun, using the MAX2839AS Evaluation Kit.)

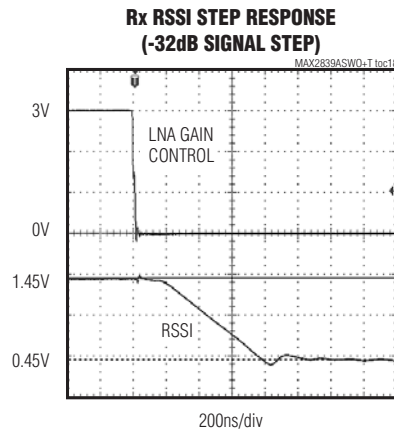
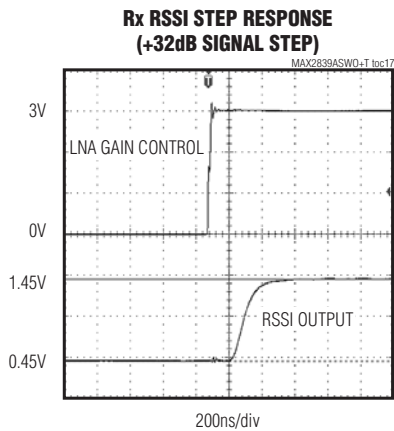
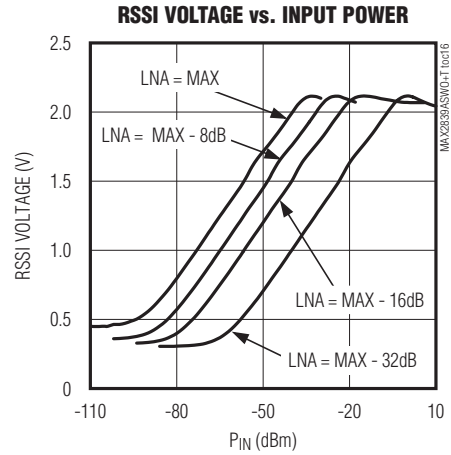
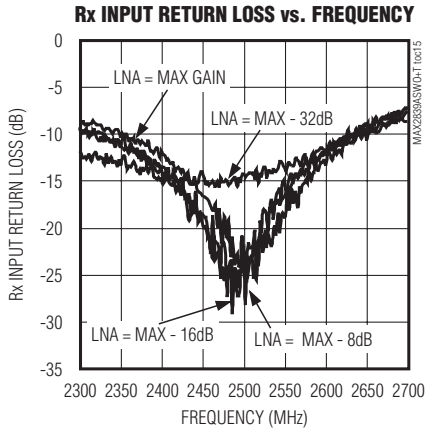
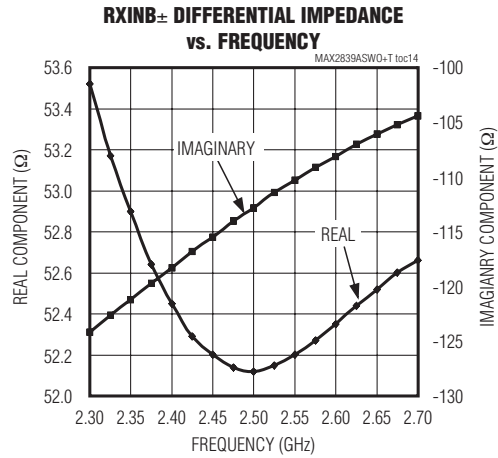
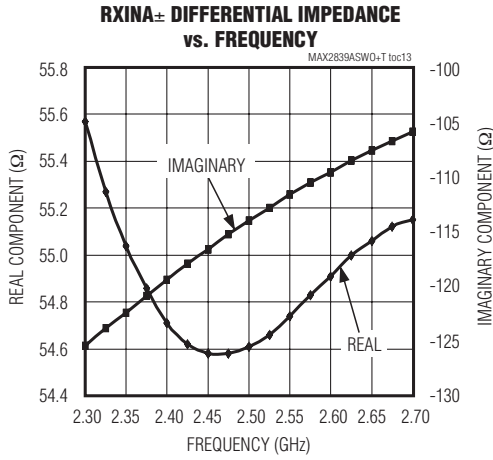

2.3GHz to 2.7GHz MIMO Wireless Broadband RF Transceiver

MAX2839AS

Typical Operating Characteristics (continued)

($V_{CC_} = 2.8V$, $T_A = +25^\circ C$, $f_{LO} = 2.5GHz$, $f_{REF} = 40MHz$, $\overline{CS} = high$, $RXHP = SCLK = DIN = low$, RF BW = 10MHz, Tx output at 50 Ω unbalanced output of balun, using the MAX2839AS Evaluation Kit.)

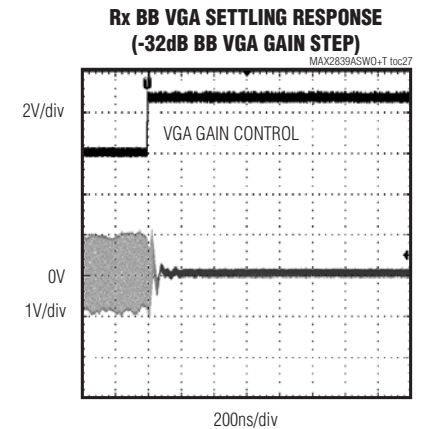
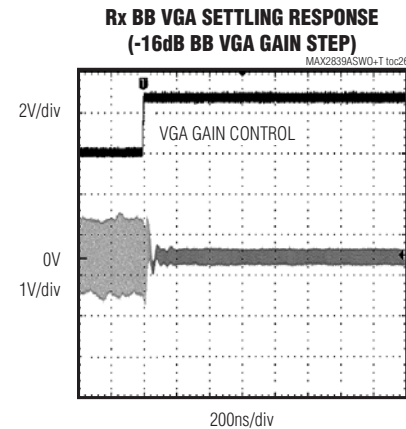
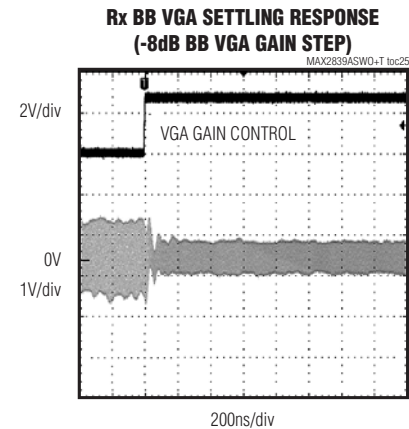
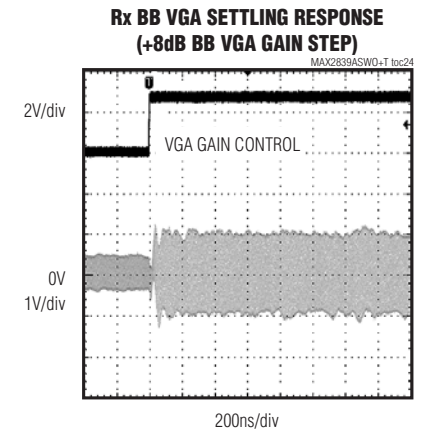
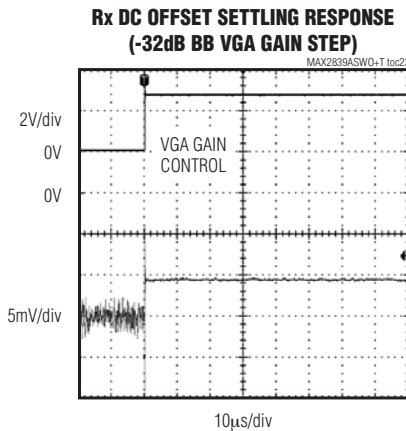
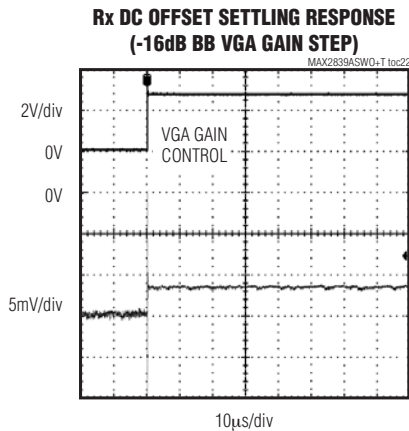
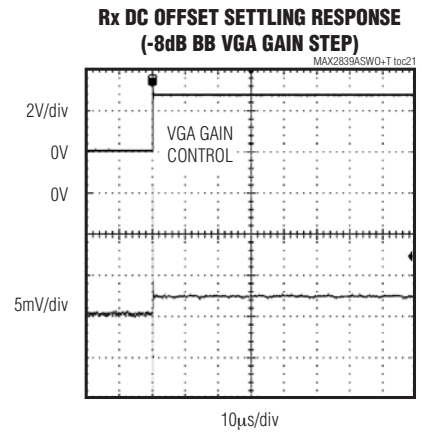
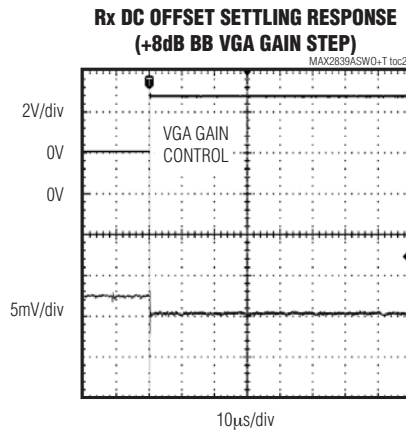
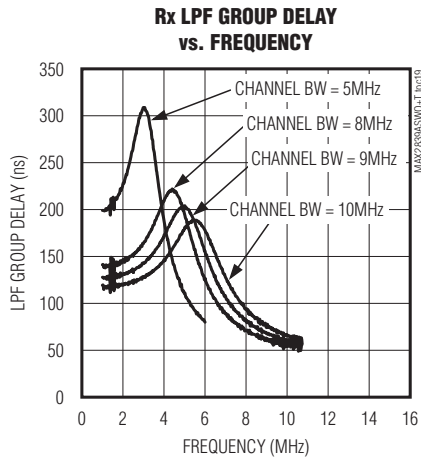

2.3GHz to 2.7GHz MIMO Wireless Broadband RF Transceiver

Typical Operating Characteristics (continued)

($V_{CC_1} = 2.8V$, $T_A = +25^\circ C$, $f_{LO} = 2.5GHz$, $f_{REF} = 40MHz$, $\overline{CS} = high$, $RXHP = SCLK = DIN = low$, $RF BW = 10MHz$, Tx output at 50Ω unbalanced output of balun, using the MAX2839AS Evaluation Kit.)

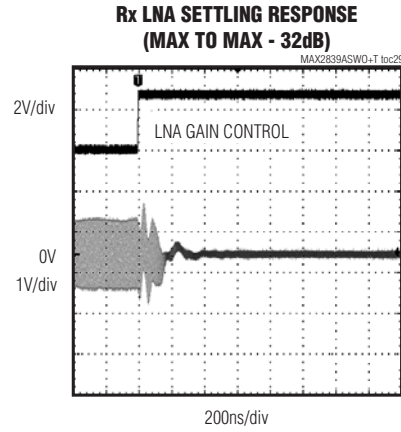
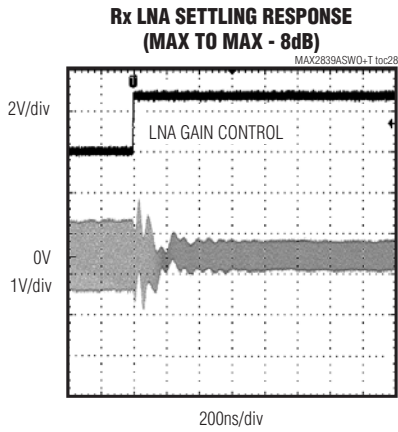

Rx BB FREQUENCY RESPONSE

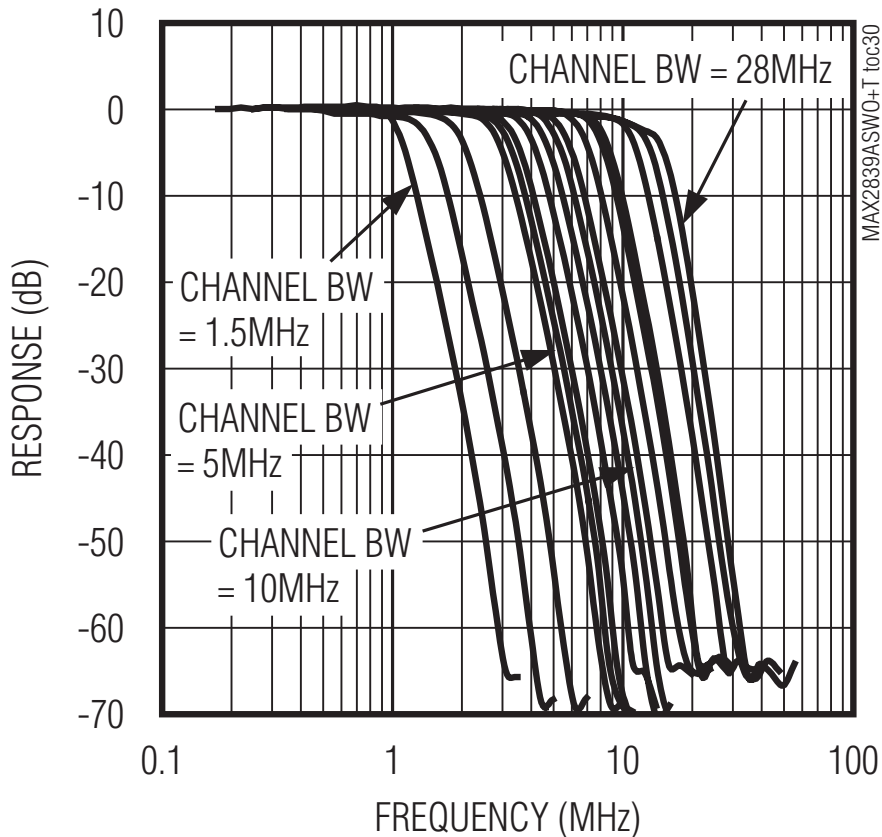

2.3GHz to 2.7GHz MIMO Wireless Broadband RF Transceiver

MAX2839AS

Typical Operating Characteristics (continued)

($V_{CC_1} = 2.8V$, $T_A = +25^\circ C$, $f_{LO} = 2.5GHz$, $f_{REF} = 40MHz$, $\overline{CS} = high$, $RXHP = SCLK = DIN = low$, $RF BW = 10MHz$, Tx output at 50Ω unbalanced output of balun, using the MAX2839AS Evaluation Kit.)

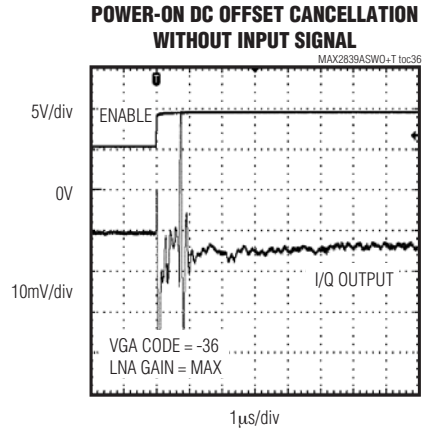
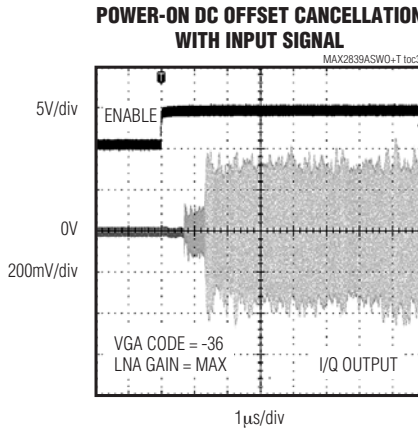
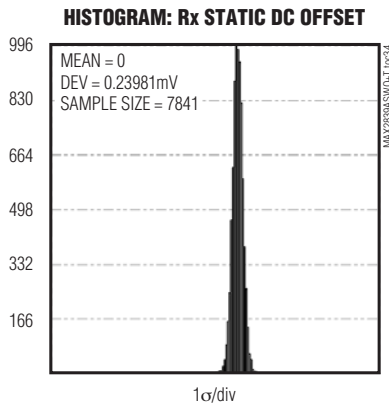
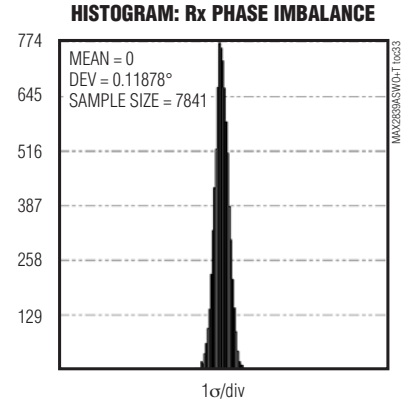
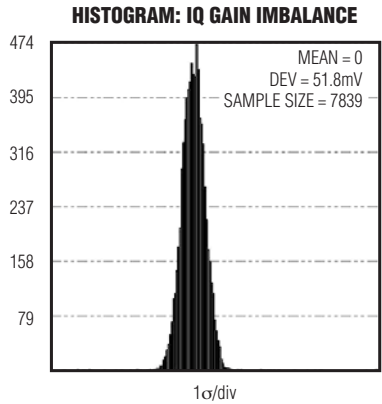
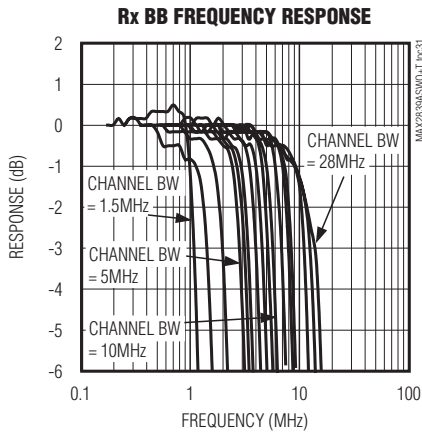

2.3GHz to 2.7GHz MIMO Wireless Broadband RF Transceiver

Typical Operating Characteristics (continued)

($V_{CC} = 2.8V$, $T_A = +25^\circ C$, $f_{LO} = 2.5GHz$, $f_{REF} = 40MHz$, $\overline{CS} = high$, $RXHP = SCLK = DIN = low$, RF BW = 10MHz, Tx output at 50% unbalanced output of balun, using the MAX2839AS Evaluation Kit.)

Tx SUPPLY CURRENT vs. SUPPLY VOLTAGE

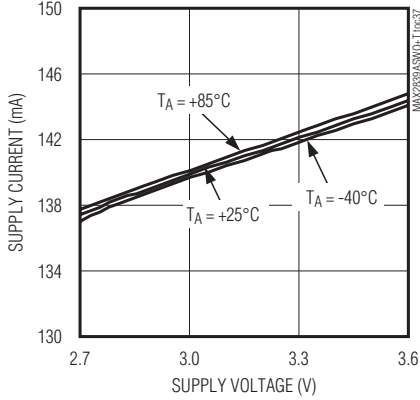

Tx BASEBAND FREQUENCY RESPONSE

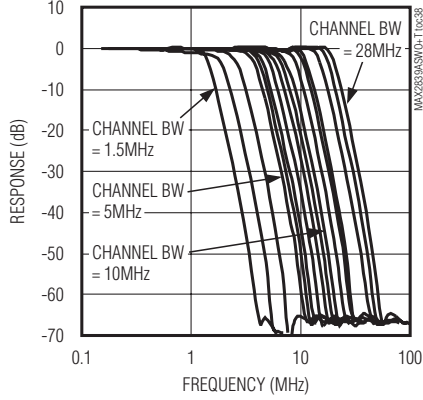

Tx BASEBAND FREQUENCY RESPONSE

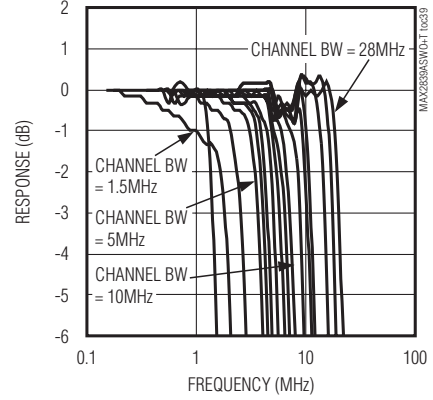

Tx OUTPUT POWER vs. FREQUENCY (Tx GAIN = MAX - 3dB)

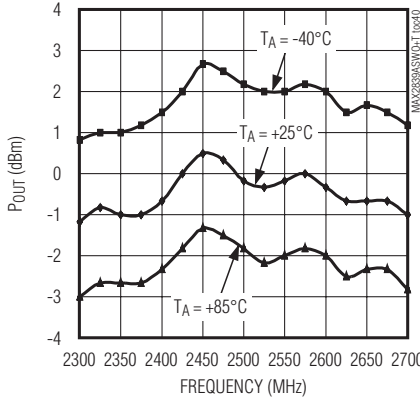

Tx OUTPUT POWER vs. GAIN SETTING

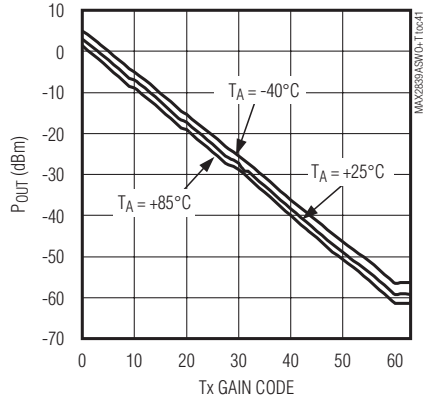

Tx OUTPUT SPECTRUM (10MHz CHANNEL BANDWIDTH, 16 QAM FUSC)

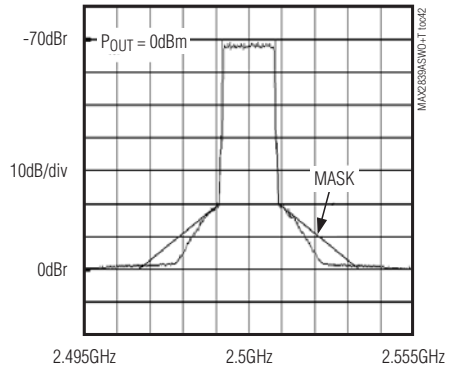

Tx OUTPUT SPECTRUM (10MHz CHANNEL BANDWIDTH, 64 QAM FUSC)

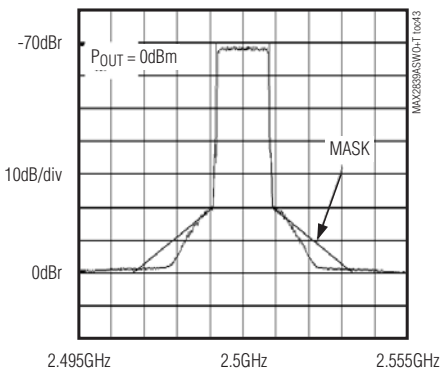

Tx CARRIER LEAKAGE vs. FREQUENCY

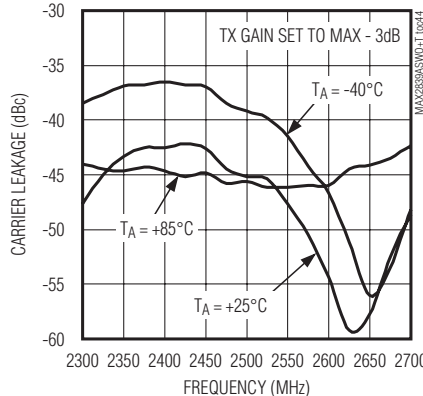

Tx CARRIER LEAKAGE vs. GAIN SETTING

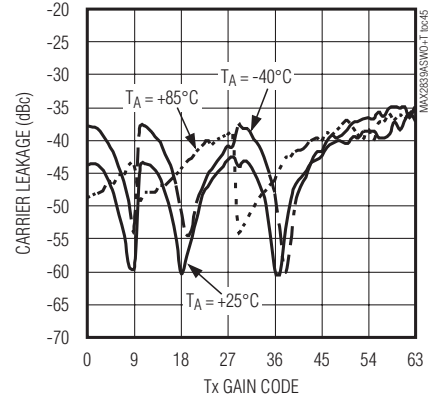

2.3GHz to 2.7GHz MIMO Wireless Broadband RF Transceiver

MAX2839AS

Typical Operating Characteristics (continued)

($V_{CC} = 2.8V$, $T_A = +25^\circ C$, $f_{LO} = 2.5GHz$, $f_{REF} = 40MHz$, $\overline{CS} = high$, $RXHP = SCLK = DIN = low$, $RF BW = 10MHz$, Tx output at 50 Ω unbalanced output of balun, using the MAX2839AS Evaluation Kit.)

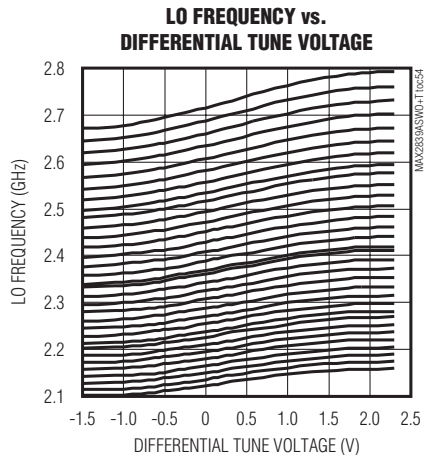
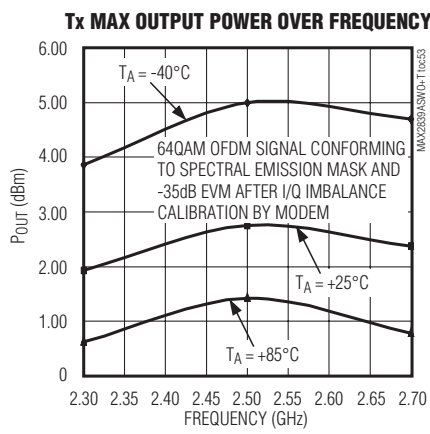
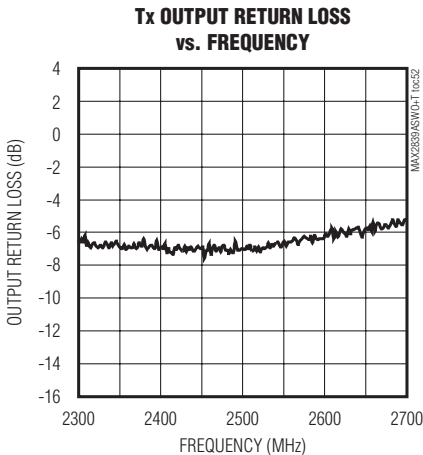
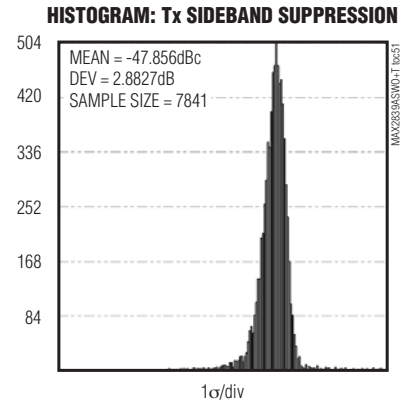
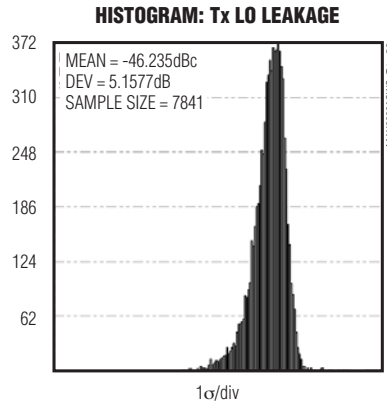
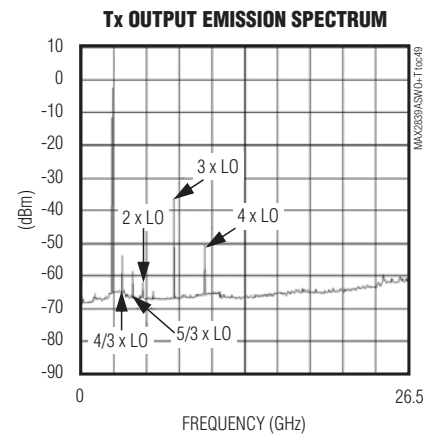
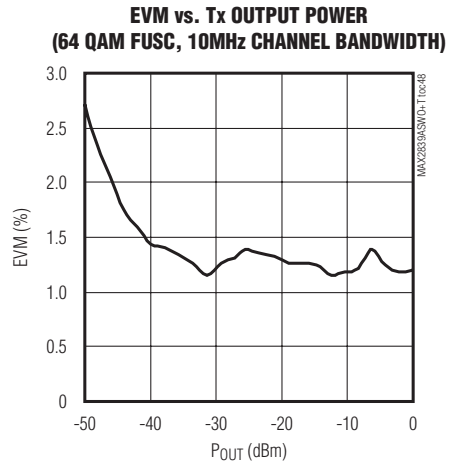
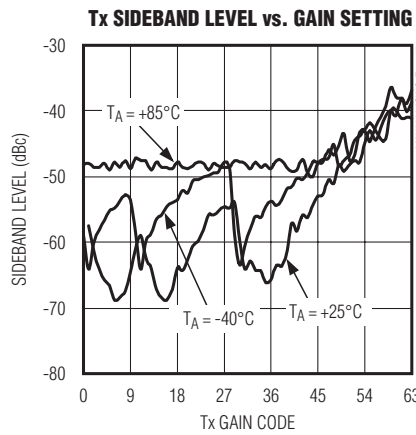
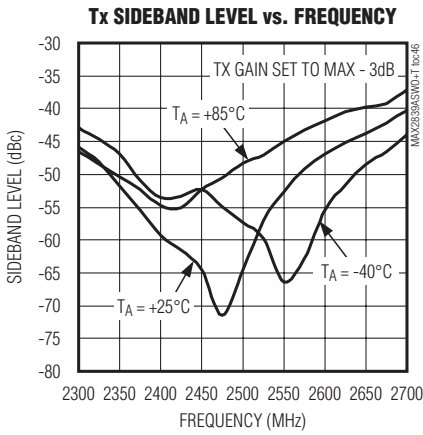

2.3GHz to 2.7GHz MIMO Wireless Broadband RF Transceiver

Typical Operating Characteristics (continued)

($V_{CC_2} = 2.8V$, $T_A = +25^\circ C$, $f_{LO} = 2.5GHz$, $f_{REF} = 40MHz$, $\overline{CS} = high$, $RXHP = SCLK = DIN = low$, RF BW = 10MHz, Tx output at 50Ω unbalanced output of balun, using the MAX2839AS Evaluation Kit.)

PHASE NOISE vs. OFFSET FREQUENCY

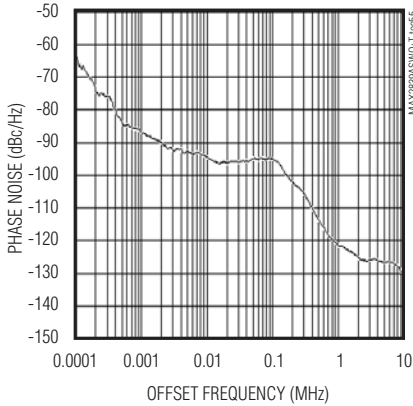

VCO GAIN vs. DIFFERENTIAL TUNE VOLTAGE

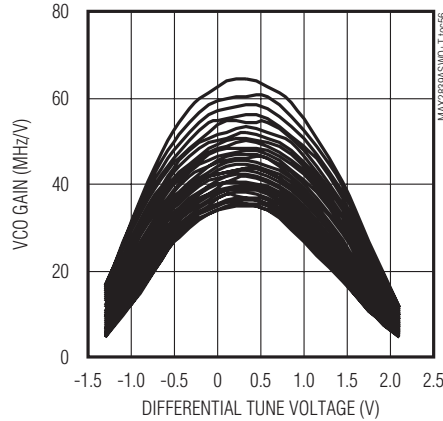

CHANNEL-SWITCHING FREQUENCY SETTLING (2.3GHz TO 2.7GHz, AUTOMATIC VCO SUB-BAND SELECTION)

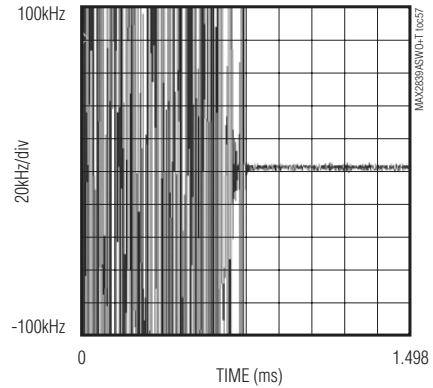

CHANNEL-SWITCHING FREQUENCY SETTLING (2.7GHz TO 2.3GHz, AUTOMATIC VCO SUB-BAND SELECTION)

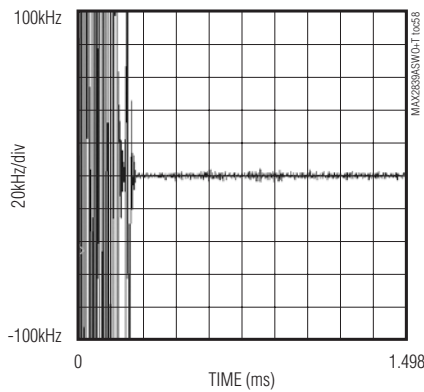

CHANNEL-SWITCHING FREQUENCY SETTLING (2.3GHz TO 2.7GHz, MANUAL VCO SUB-BAND SELECTION)

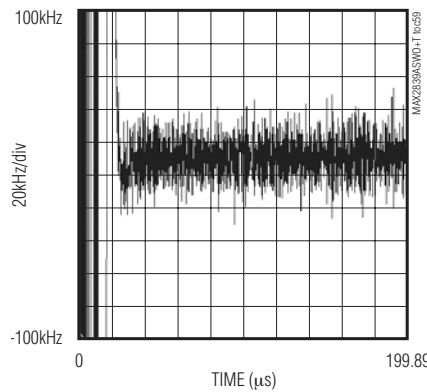

CHANNEL-SWITCHING FREQUENCY SETTLING (2.7GHz TO 2.3GHz, MANUAL VCO SUB-BAND SELECTION)

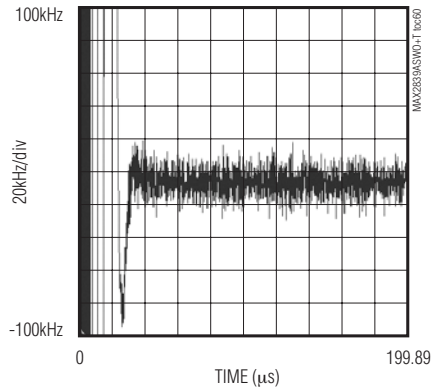

Tx-TO-Rx TURNAROUND FREQUENCY GLITCH SETTling

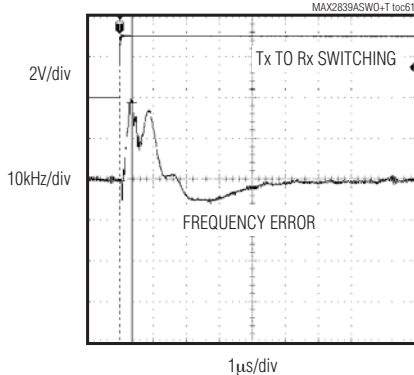

Rx-TO-Tx TURNAROUND FREQUENCY GLITCHING SETTling

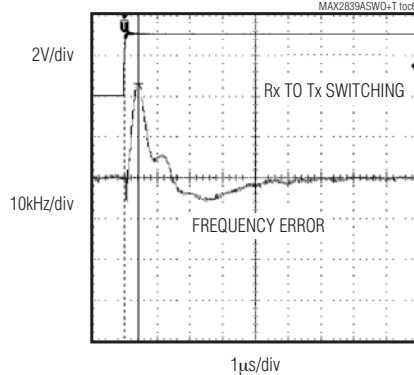

2.3GHz to 2.7GHz MIMO Wireless Broadband RF Transceiver

Bump Description

MAX2839AS

BUMP	NAME	FUNCTION
1	GNDRXLNA_A	Receiver A LNA Ground
2	VCCRXLNA_A	Receiver A LNA Supply Voltage. Bypass with a 22pF capacitor as close as possible to the pin.
3	VCCRXLNA_B	Receiver B LNA Supply Voltage. Bypass with a 22pF capacitor as close as possible to the pin.
4	GND_LNA_B	Receiver B LNA Ground
5	RXINB+	Receiver B LNA Differential Input Plus. Input is internally DC-coupled.
6	GND_MXR_B	Receiver B Mixer Ground
7	B2	Receiver and Transmitter Gain-Control Logic Input Bit 2
8	B3	Receiver and Transmitter Gain-Control Logic Input Bit 3
9	B4	Receiver and Transmitter Gain-Control Logic Input Bit 4
10	VCCTXPAD	Supply Voltage for Transmitter Power Amplifier Driver. Bypass with a 22pF capacitor as close as possible to the pin.
11	GND1_PAD_RF	Transmit Power Amplifier Driver Ground
12	GND2_PAD_RF	Transmit Power Amplifier Driver Ground
13	PABIAS	Transmit External Power Amplifier Bias DAC Output
14	GND_TXMX	Transmit Upconverter Ground
15	SCLK	Serial-Clock Logic Input of 4-Wire Serial Interface
16	REFCLK	Reference Clock Input. AC-couple a reference clock to this analog input.
17	VCCXTAL	Crystal Oscillator Supply Voltage. Bypass with a 100nF capacitor as close as possible to the pin.
18	VCCCP	PLL Charge-Pump Supply Voltage. Bypass with a 100nF capacitor as close as possible to the pin.
19	GNDCP	Charge-Pump Ground
20	CPOUT+	Differential Charge-Pump Output Plus. Connect the frequency synthesizer's loop filter between CPOUT+ and CPOUT- (see the <i>Typical Operating Circuit</i>).
21	GNDVCO	VCO Ground
22	VCOBYP	On-Chip VCO Regulator Output Bypass. Bypass with a 1μF capacitor to GND. Do not connect other circuitry to this point.
23	VCCVCO	VCO Supply Voltage. Bypass with a 22nF capacitor as close as possible to the pin.
24	GND_LO	Local Oscillator Generation Ground
25	\overline{CS}	Active-Low Chip-Select Logic Input of 4-Wire Serial Interface
26	GND_RXBB_B	Receiver B Baseband Ground
27	RXBBIB+	Receiver B Baseband I-Channel Differential Output Plus
28	RXBBQB+	Receiver B Baseband Q-Channel Differential Output Plus
29	B6	Receiver and Transmitter Gain-Control Logic Input Bit 6
30	RXBBQA-	Receiver A Baseband Q-Channel Differential Output Minus
31	RXBBQA+	Receiver A Baseband Q-Channel Differential Output Plus
32	VCCR XVGA	Receiver VGA Supply Voltage. Bypass with a 100nF capacitor as close as possible to the pin.
33	GND_RXBB_A	Receiver A Baseband Ground
34	GND_RXLOGEN	Receiver Divide-by-2 Ground
35	GND_MXR_A	Receiver A Mixer Ground
36	GND_LNA_A	Receiver A LNA Ground
37	TXBBQ-	Transmitter Baseband Q-Channel Differential Input Minus
38	CLKOUT_DIV	Clockout Divide Ratio Select Logic Input

2.3GHz to 2.7GHz MIMO Wireless Broadband RF Transceiver

Bump Description (continued)

BUMP	NAME	FUNCTION
39	GNDRLNA_B	Receiver B LNA Ground
40	RXINB-	Receiver B LNA Differential Input Minus. Input is internally DC-coupled.
41	TXRX	Transmit/Receive Mode Enable Logic Input
42	B5	Receiver and Transmitter Gain-Control Logic Input Bit 5
43	TXOUT+	Power Amplifier Driver Differential Output Plus. The pin is biased at $V_{CC}/2$ internally.
44	B1	Receiver and Transmitter Gain-Control Logic Input Bit 1
45	TXOUT-	Power Amplifier Driver Differential Output Minus. The pin is biased at $V_{CC}/2$ internally.
46	V _{CC} TXMX	Transmitter Upconverter Supply Voltage. Bypass with a 22pF capacitor as close as possible to the pin.
47	CLKOUT	Reference Clock Buffer Output
48	GND_XTAL	Crystal Oscillator Ground
49	GND_DIG	PLL Digital Ground
50	V _{CC} _DIG	PLL Digital Supply Voltage. Bypass with a 100nF capacitor as close as possible to the pin.
51	CPOUT-	Differential Charge-Pump Output Minus. Connect the frequency synthesizer's loop filter between CPOUT+ and CPOUT- (see the <i>Typical Operating Circuit</i>).
52, 67	GND	Ground. Connect to the PCB ground plane.
53	DIN	Data Logic Input of 4-Wire Serial Interface
54	GND_PAD_BIAS	Transmit Bias Ground
55	XTAL1	XTAL Input. AC-couple crystal to this analog pin.
56	RXHP	Receiver I- and Q-Channel AC-Coupling Highpass Corner Frequency Selection Logic Input
57	RXBBIA-	Receiver A Baseband I-Channel Differential Output Minus
58	RXBBIA+	Receiver A Baseband I-Channel Differential Output Plus
59	TXBBI+	Transmitter Baseband I-Channel Differential Input Plus
60	TXBBQ+	Transmitter Baseband Q-Channel Differential Input Plus
61	V _{CC} RXMX	Receiver Downconverters Supply Voltage. Bypass with a 22pF capacitor as close as possible to the pin.
62	RXINA-	Receiver A LNA Differential Input Minus. Input is internally DC-coupled.
63	RXINA+	Receiver A LNA Differential Input Plus. Input is internally DC-coupled.
64	B0	Receiver and Transmitter Gain-Control Logic Input Bit 0
65	ENABLE	Transceiver Enable Logic Input
66	DOUT	Data Logic Output of 4-Wire Serial Interface
68	RXBBIB-	Receiver B Baseband I-Channel Differential Output Minus
69	RXBBQB-	Receiver B Baseband Q-Channel Differential Output Minus
70	RSSI	Receiver Signal Strength Output
71	B7	Receiver Gain-Control Logic Input Bit 7
72	V _{CC} RXFL	Receiver Baseband Filter Supply Voltage. Bypass with a 100nF capacitor as close as possible to the pin.
73	TXBBI-	Transmitter Baseband I-Channel Differential Input Minus

2.3GHz to 2.7GHz MIMO Wireless Broadband RF Transceiver

MAX2839AS

Table 1. Operating Mode

MODE	MODE CONTROL LOGIC INPUTS				CIRCUIT BLOCK STATES				
	ENABLE PIN	TXRX PIN	SPI REG1 D<3>	SPI REG16 D<1:0>	Rx PATH	Tx PATH	PLL, VCO, LO GEN	CALIBRATION SECTIONS ON	CLOCK OUTPUT
Shutdown	0	0	X	XX	Off	Off	Off	None	Off
Clock-Out Only	1	X	X	X0	Off	Off	Off	None	On
Clock-Out Only	X	1	X	X0	Off	Off	Off	None	On
Standby	0	1	X	01	Off	Off	On or Off	None	On
Rx (1x2 MIMO)	1	1	1	01	On	Off	On	None	On
Rx (1x1 SISO)	1	1	0	01	On (RX_A)	Off	On	None	On
Tx	1	0	X	01	Off	On	On	None	On
Tx Calibration	1	0	X	11	Off	On (except PA driver)	On SPI REG7D<7> = 1	AM detector + Rx I, Q buffers	On
RX_A Calibration (Loopback)	1	1	0	11	On (except LNA)	On (except PA driver)	On SPI REG26D<3> = 1	Loopback	On
RX_B Calibration (Loopback)	1	1	1	11	On (except LNA)	On (except PA driver)	On SPI REG26D<3> = 1	Loopback	On

Detailed Description

Modes of Operation

The modes of operation for the MAX2839AS are shutdown, clock-out only, standby, receive, transmit, transmitter calibration, and receiver calibration. See Table 1 for a summary of the modes of operation. When the parts are active, various blocks can be shutdown individually by programming different SPI registers.

Shutdown Mode

The MAX2839AS features a low-power shutdown mode. In shutdown mode, all circuit blocks are powered down, except the 4-wire serial bus and its internal programmable registers.

Clock-Out Only

In clock-out mode, the entire transceiver is off except the divided reference clock output on the CLKOUT pin and the clock divider, which remain on.

Standby Mode

The standby mode is used to enable the frequency synthesizer block while the rest of the device is powered down. In this mode, the PLL, VCO, and LO gener-

ator are on so that Tx or Rx modes can be quickly enabled from this mode. These and other blocks can be selectively enabled in this mode by programming different SPI registers.

Receive (Rx) Mode

In receive mode, all Rx circuit blocks are powered on and active. Antenna signal is applied; RF is downconverted, filtered, and buffered at Rx BB I and Q outputs. Either receiver A or both receivers can be enabled. Receiver B cannot be enabled by itself.

Transmit (Tx) Mode

In transmit mode, all Tx circuit blocks are powered on. The external PA is powered on after a programmable delay using the on-chip PA bias DAC.

Transmitter (Tx) Calibration Mode

All Tx circuit blocks except PA driver and external PA are powered on and active. The AM detector and receiver I/Q channel buffers are also on, along with multiplexers in the receiver side to route this AM detector's signal to each I and Q differential outputs. When required, the I/Q lowpass filter can be bypassed.

2.3GHz to 2.7GHz MIMO Wireless Broadband RF Transceiver

Receiver (Rx) Calibration or Loopback

Part of the Rx and Tx circuit blocks except LNA and PA driver are powered on and active. The transmitter I/Q input signals are upconverted to RF, and the output of the Tx gain control block (VGA) is fed to the receiver at the input of the downconverter. Either receiver A or both receivers can be connected to the transmitter and powered on. The I/Q lowpass filters are not present in the transmitter signal path (they are bypassed).

Programmable Registers and 4-Wire SPI Interface

The MAX2839AS includes 32 programmable 16-bit registers. The most significant bit (MSB) is the read/write selection bit. The next 5 bits are register address. The

10 least significant bits (LSBs) are register data. Register data is loaded through the 4-wire SPI/MICROWIRE™-compatible serial interface. Data at DIN is shifted in MSB first and is framed by \overline{CS} . When \overline{CS} is low, the clock is active, and input data is shifted at the rising edge of the clock. During the read mode, register data selected by address bits is shifted out to DOUT at the falling edges of the clock. At the \overline{CS} rising edge, the 10-bit data bits are latched into the register selected by address bits. See Figure 1. The register values are preserved in shutdown mode as long as the power-supply voltage is maintained. After power-up, the user must program all register values.

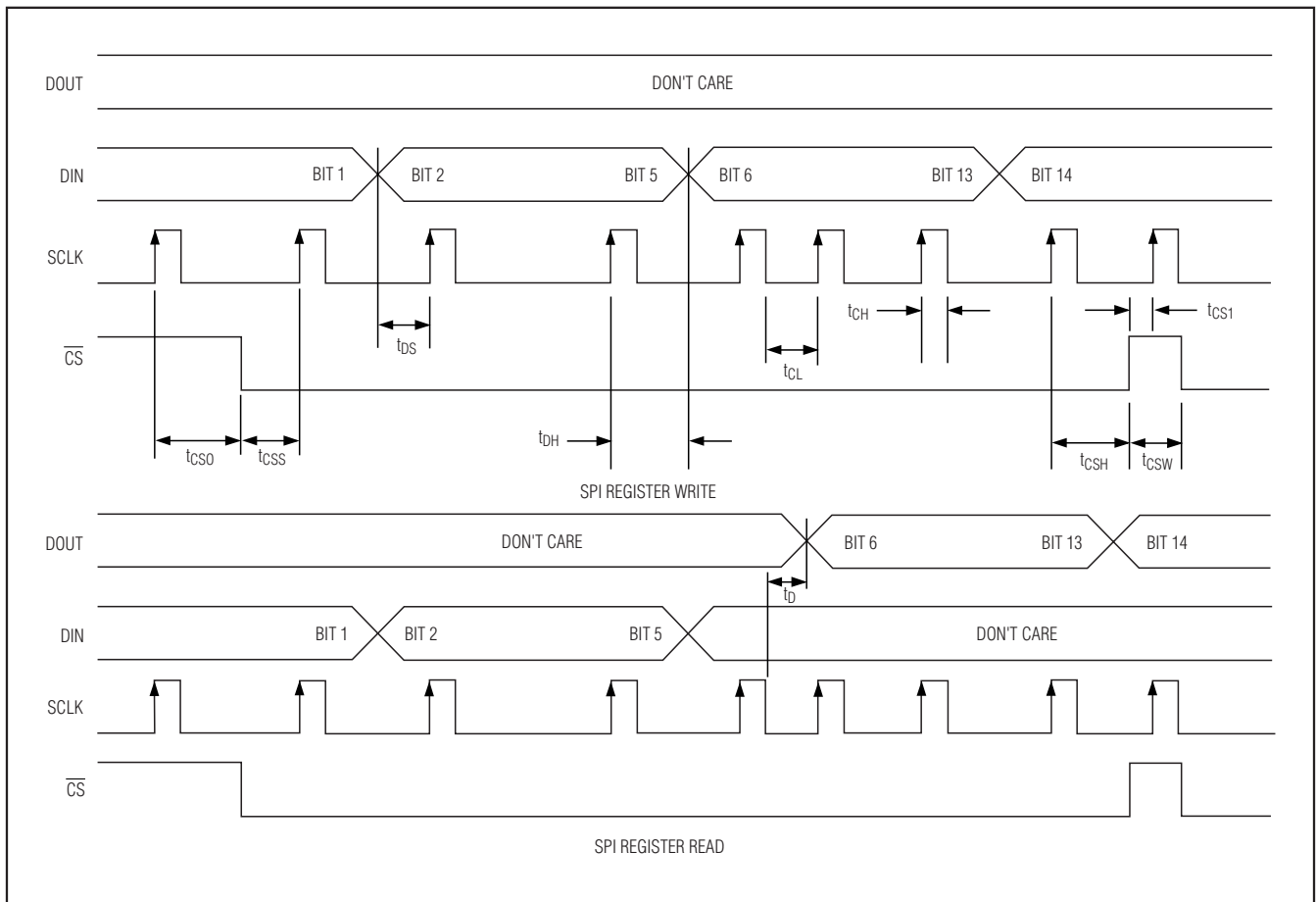

Figure 1. 4-Wire SPI Serial-Interface Timing Diagram

MICROWIRE is a trademark of National Semiconductor Corp.

2.3GHz to 2.7GHz MIMO Wireless Broadband RF Transceiver

SPI Register Definitions

(All values in the register definition table are typical numbers. The MAX2839AS SPI does not have a power-on-default feature; the user must program all SPI addresses for normal operation. Prior to use of any untested settings, contact the factory.)

Table 2. MAX2839AS Register Summary

REGISTER NO.	REGISTER NAME	DEFAULT	FUNCTIONS
0	RX_ENABLE	000	Reserved for internal use
1	RX_RF_1	00C	<ul style="list-style-type: none"> LNA band select, MIMO mode select Rx I/Q phase error correction
2	RX_RF_2	081	<ul style="list-style-type: none"> LNA gain SPI control enable Rx I/Q phase error SPI control enable
3	RX_RF/LPF	1B9	Reserved for internal use
4	LPF	3E6	<ul style="list-style-type: none"> RF channel bandwidth select
5	LPF/VGA_1	100	<ul style="list-style-type: none"> RX_A LNA and VGA gain controls LPF operating mode select
6	LPF/VGA_2	000	<ul style="list-style-type: none"> RX_B LNA and VGA gain controls Rx VGA common-mode select
7	RSSI/VGA	208	<ul style="list-style-type: none"> RSSI pin output select, operating mode as a function of RXHP, and receiver select Rx baseband outputs routing select
8	RX_TOP_SPI_1	222	<ul style="list-style-type: none"> Rx VGA gain SPI control enable LPF operating mode select enable
9	RX_TOP_SPI_2	018	<ul style="list-style-type: none"> Temperature sensor enable, and ADC readout trigger DOUT output selection, drive select, three-state output select
10	TX_TOP_SPI	00C	<ul style="list-style-type: none"> Tx AM detector gain and filter bandwidth controls
11	TEMP_SEN	004	<ul style="list-style-type: none"> Temperature sensor ADC readout
12	HPFSM 1	24F	<ul style="list-style-type: none"> 10MHz HPC duration select when triggered by RXEN or LNA gain 600kHz HPC duration select when triggered by RXEN or LNA gain
13	HPFSM 2	150	<ul style="list-style-type: none"> 100kHz HPC duration select when triggered by RXEN or LNA gain 30kHz HPC duration select when triggered by RXEN or LNA gain 1kHz HPC duration select when triggered by RXEN
14	HPFSM 3	3C5	<ul style="list-style-type: none"> 1kHz HPC duration select when triggered by LNA gain HPC rising edge delay and final highpass corner select HPC on-hold corner select as a function of RXHP HPC state machine retriggered by LNA gain enable
15	HPFSM 4	201	<ul style="list-style-type: none"> HPC state machine clock divider, sequence bypass, and RXHP dependent select
16	BLK_SPI_EN	01C	<ul style="list-style-type: none"> Block enabled by SPI
17	FRAC_DIV_1	155	<ul style="list-style-type: none"> Last 10 of 20 fractional divider bits
18	FRAC_DIV_2	155	<ul style="list-style-type: none"> First 10 of 20 fractional divider bits
19	INT_DIV	153	<ul style="list-style-type: none"> Integer divider bits LO generation band select
20	SYNTH_CONFIG_1	249	<ul style="list-style-type: none"> Reference divider ratio CLKOUT buffer drive select
21	SYNTH_CONFIG_2	02D	Reserved for internal use

2.3GHz to 2.7GHz MIMO Wireless Broadband RF Transceiver

Table 2. MAX2839AS Register Summary (continued)

REGISTER NO.	REGISTER NAME	DEFAULT	FUNCTIONS
22	VAS_CONFIG	1A9	<ul style="list-style-type: none"> VAS operating mode select, relock location, clock divide ratio, delay counter ratio, and triggering
23	LO_MISC_CONFIG	24F	<ul style="list-style-type: none"> VAS sub-band SPI overwrite Crystal oscillator bias select
24	XTAL_CONFIG	180	<ul style="list-style-type: none"> Crystal oscillator core enable, and frequency tuning
25	VCO_CONFIG	000	Reserved for internal use
26	LOGEN_CONFIG	3C0	<ul style="list-style-type: none"> VAS test signal select VTUNE test signal select LOGEN G_m enable
27	TXLO_I/Q_CONFIG	280	<ul style="list-style-type: none"> Tx LO I/Q phase adjustment by SPI enable, and phase adjustment select Tx DC correction by SPI enable Tx VGA gain control by SPI enable
28	PA_BIAS_DAC	0C0	<ul style="list-style-type: none"> PA DAC output current select, and turn-on delay control
29	TX_GAIN_CONFIG	03F	<ul style="list-style-type: none"> Tx VGA gain control
30	TX_DC CORR_1	380	<ul style="list-style-type: none"> Tx DC offset correction for I-channel PA DAC output type select, and voltage mode output select
31	TX_DC_CORR_2	340	<ul style="list-style-type: none"> Tx DC offset correction for Q-channel PA DAC clock-divide ratio

REGISTER NAME	ADDRESS BITS					DATA BITS									
	A4	A3	A2	A1	A0	D9	D8	D7	D6	D5	D4	D3	D2	D1	D0
RX_ENABLE	0	0	0	0	0	0	0	0	0	0	0	0	0	0	0
RX_RF_1	0	0	0	0	1	0	0	0	0	0	0	1	1	0	0
RX_RF_2	0	0	0	1	0	0	0	1	0	0	0	0	0	0	1
RX_RF/LPF	0	0	0	1	1	0	1	1	0	1	1	1	0	0	1
LPF	0	0	1	0	0	1	1	1	1	1	0	0	1	1	0
LPF/VGA_1	0	0	1	0	1	0	1	0	0	0	0	0	0	0	0
LPF/VGA_2	0	0	1	1	0	0	0	0	0	0	0	0	0	0	0
RSSI/VGA	0	0	1	1	1	1	0	0	0	0	0	1	0	0	0
RX_TOP_SPI_1	0	1	0	0	0	1	0	0	0	1	0	0	0	1	0
RX_TOP_SPI_2	0	1	0	0	1	0	0	0	0	0	1	1	0	0	0
TX_TOP_SPI	0	1	0	1	0	0	0	0	0	0	0	1	1	0	0
TEMP_SEN	0	1	0	1	1	0	0	0	0	0	0	0	1	0	0
HPFSM 1	0	1	1	0	0	1	0	0	1	0	0	1	1	1	1
HPFSM 2	0	1	1	0	1	0	1	0	1	0	1	0	0	0	0
HPFSM 3	0	1	1	1	0	1	1	1	1	0	0	0	1	0	1
HPFSM 4	0	1	1	1	1	1	0	0	0	0	0	0	0	0	1
BLK_SPI_EN	1	0	0	0	0	0	0	0	0	0	1	1	1	0	0
FRAC_DIV_1	1	0	0	0	1	0	1	0	1	0	1	0	1	0	1
FRAC_DIV_2	1	0	0	1	0	0	1	0	1	0	1	0	1	0	1
INT_DIV	1	0	0	1	1	0	1	0	1	0	1	0	0	1	1

2.3GHz to 2.7GHz MIMO Wireless Broadband RF Transceiver

MAX2839AS

Table 2. MAX2839AS Register Summary (continued)

REGISTER NAME	ADDRESS BITS					DATA BITS									
	A4	A3	A2	A1	A0	D9	D8	D7	D6	D5	D4	D3	D2	D1	D0
SYNTH_CONFIG_1	1	0	1	0	0	1	0	0	1	0	0	1	0	0	1
SYNTH_CONFIG_2	1	0	1	0	1	0	0	0	0	1	0	1	1	0	1
VAS_CONFIG	1	0	1	1	0	0	1	1	0	1	0	1	0	0	1
LO_MISC_CONFIG	1	0	1	1	1	1	0	0	1	0	0	1	1	1	1
XTAL_CONFIG	1	1	0	0	0	0	1	1	0	0	0	0	0	0	0
VCO_CONFIG	1	1	0	0	1	0	0	0	0	0	0	0	0	0	0
LOGEN_CONFIG	1	1	0	1	0	1	1	1	1	0	0	0	0	0	0
TXLO_I/Q_CONFIG	1	1	0	1	1	1	0	1	0	0	0	0	0	0	0
PA_BIAS_DAC	1	1	1	0	0	0	0	1	1	0	0	0	0	0	0
TX_GAIN_CONFIG	1	1	1	0	1	0	0	0	0	1	1	1	1	1	1
TX_DC CORR_1	1	1	1	1	0	1	1	1	0	0	0	0	0	0	0
TX_DC CORR_2	1	1	1	1	1	1	1	0	1	0	0	0	0	0	0

Table 3. Register 0: RX_ENABLE Register (Address = 00000, Default = 000HEX)

BIT NAME	BIT LOCATION (0 = LSB)	DESCRIPTION
RESERVED	9:0	Reserved bits—set to default

Table 4. Register 1: RX_RF_1 Register (Address = 00001, Default = 00CHEX)

BIT NAME	BIT LOCATION (0 = LSB)	DESCRIPTION
RESERVED	9:4	Reserved bits—set to default
MIMO_MODE_SEL	3	MIMO mode selection. 0 = RX_A 1 = RX_A + RX_B (default)
RESERVED	2:1	Reserved bits—set to default
LNA_BAND	0	LNA output LC tank center frequency select. 0 = 2.3GHz to 2.5GHz (default) 1 = 2.5GHz to 2.7GHz

Table 5. Register 2: RX_RF_2 Register (Address = 00010, Default = 081HEX)

BIT NAME	BIT LOCATION (0 = LSB)	DESCRIPTION
RESERVED	9:1	Reserved bits—set to default
LNA_GAIN_SPI_EN	0	LNA gain control select. 0 = LNA gain controlled by external pins B7 and B6 1 = LNA gain controlled by SPI through register 6 bits 1:0 (default)

2.3GHz to 2.7GHz MIMO Wireless Broadband RF Transceiver

Table 6. Register 3: RX_RF/LPF Register (Address = 00011, Default = 1B9HEX)

BIT NAME	BIT LOCATION (0 = LSB)	DESCRIPTION
RESERVED	9:0	Reserved bits—set to default

Table 7. Register 4: LPF Register (Address = 00100, Default = 3E6HEX)

BIT NAME	BIT LOCATION (0 = LSB)	DESCRIPTION
FT<3:0>	9:6	RF channel bandwidth select. Test at RFBW 5MHz, 10MHz, and 28MHz. 0000 = 1.75MHz 0001 = 2.5MHz 0010 = 3.5MHz 0011 = 5.0MHz 0100 = 5.5MHz 0101 = 6.0MHz 0110 = 7.0MHz 0111 = 8.0MHz 1000 = 9.0MHz 1001 = 10.0MHz 1010 = 12.0MHz 1011 = 14.0MHz 1100 = 15.0MHz 1101 = 20.0MHz 1110 = 24.0MHz 1111 = 28.0MHz (default)
RESERVED	5:0	Reserved bits—set to default

Table 8. Register 5: LPF/VGA_1 Register (Address = 00101, Default = 100HEX)

BIT NAME	BIT LOCATION (0 = LSB)	DESCRIPTION
RESERVED	9:8	Reserved bits—set to default
VGA1<5:0>	7:2	Receiver 1 VGA attenuation settings through SPI. Active when register 8 D<1> = 1. 000000 = Max gain (default) 000001 = Max - 1dB 111110 = Max - 62dB 111111 = Max - 63dB (min gain) Test at settings 000000, 000001, 001000, 010000, 100000, 110110, and 111111.
LNA1<1:0>	1:0	Receiver 1 LNA gain settings through SPI. Active when register 2 D<0> = 1. 00 = Max gain (default) 01 = Max - 8dB 10 = Max - 16dB 11 = Max - 32dB

2.3GHz to 2.7GHz MIMO Wireless BroadbandRF Transceiver

Table 9. Register 6: LPF/VGA_2 Register (Address = 00110, Default = 000HEX)

BIT NAME	BIT LOCATION (0 = LSB)	DESCRIPTION
BUFF_VCM<1:0>	9:8	Rx VGA output common-mode voltage select. 00 = 1.05V (default) 01 = 1.15V 10 = 1.25V 11 = 1.45V
VGA2<5:0>	7:2	Receiver 2 VGA attenuation settings through SPI. Active when register 8 D<1> = 1. 000000 = Max gain (default) 000001 = Max - 1dB 111110 = Max - 62dB 111111 = Max - 63dB (min gain) Test at settings 000000, 000001, 001000, 010000, 100000, 110110, and 111111.
LNA2<1:0>	1:0	Receiver 2 LNA gain settings through SPI. Active when register 2 D<0> = 1. 00 = Max gain (default) 01 = Max - 8dB 10 = Max - 16dB 11 = Max - 32dB

Table 10. Register 7: RSSI/VGA Register (Address = 00111, Default = 208HEX)

BIT NAME	BIT LOCATION (0 = LSB)	DESCRIPTION
RSSI_RXSEL	9	RSSI for receiver 1 or 2 select. 0 = RSSI for receiver 2 1 = RSSI for receiver 1 (default)
RESERVED	8	Reserved bits—set to default
SEL_IN1_IN2	7	RXBBI output select. 0 = Select Rx VGA output (default) 1 = Select Tx AM detector output
RESERVED	6:0	Reserved bits—set to default

2.3GHz to 2.7GHz MIMO Wireless Broadband RF Transceiver

Table 11. Register 8: RX_TOP_SPI_1 Register (Address = 01000, Default = 222HEX)

BIT NAME	BIT LOCATION (0 = LSB)	DESCRIPTION
RESERVED	9:3	Reserved bits—set to default
LPF_MODE_SEL	2	LPF operating mode select. 0 = LPF response changes automatically between Tx and Rx by TXRX pin (default) 1 = LPF response fixed in Tx, Rx, calibration, or trim mode as defined in register 5 D<9:8>
VGA_GAIN_SPI_EN	1	Rx VGA gain control through SPI. 0 = Rx VGA gain controlled by external pins B5:B1 1 = Rx VGA gain controlled by SPI (default)
RESERVED	0	Reserved bits—set to default

Table 12. Register 9: RX_TOP_SPI_2 Register (Address = 01001, Default = 018HEX)

BIT NAME	BIT LOCATION (0 = LSB)	DESCRIPTION
RESERVED	9:8	Reserved bits—set to default
DOUT_SEL<2:0>	7:5	DOUT pin multiplexed output select. 000 = SPI register (default) 001 = PLL lock detect. Set register 21 D<9:7> = 000 for lock-detect out. 010 = VAS and VTUNE outputs defined by register 26 D<9:6>
DOUT_CSB_SEL	4	DOUT pin three-state control. 0 = DOUT pin is independent of CSB pin 1 = DOUT pin is in three-state mode when CSB is high (default)
DOUT_DRVH	3	DOUT pin output drive select. 0 = 1x drive. Delay < 4.4ns. 1 = 4x drive. Delay < 3.1ns (default).
RESERVED	2	Reserved bits—set to default
TS_EN	1	Temperature sensor comparator and clock enable. 0 = Disabled (default) 1 = Enabled
TS_ADC_TRIG	0	Temperature sensor ADC trigger. 0 = Not trigger ADC readout (default) 1 = Trigger ADC readout. ADC is disabled automatically after readout finishes.

Table 13. Register 10: TX_TOP_SPI Register (Address = 01010, Default = 00CHEX)

BIT NAME	BIT LOCATION (0 = LSB)	DESCRIPTION
RESERVED	9:2	Reserved bits—set to default
TXCAL_GAIN<1:0>	1:0	Transmit AM detector baseband gain control select. 00 = Minimum gain (default) 01 = +10dB 10 = +20dB 11 = +30dB

2.3GHz to 2.7GHz MIMO Wireless Broadband RF Transceiver

Table 14. Register 11: TEMP_SEN Register (Address = 01011, Default = 004_{HEX})

BIT NAME	BIT LOCATION (0 = LSB)	DESCRIPTION
RESERVED	9:0	Reserved bits—set to default. Readout at DOUT pin through SPI A[4:0] = 01011, D[4:0]

Table 15. Register 12: HPFSM 1 Register (Address = 01100, Default = 24F_{HEX})

BIT NAME	BIT LOCATION (0 = LSB)	DESCRIPTION
HPC_600k_GAIN<2:0>	9:7	Rx VGA highpass corner duration at 600kHz. Triggered by LNA gain change. Test at settings 000, 001, and 011. 000 = 0 μ s 001 = 0.8 μ s 010 = 1.6 μ s 011 = 2.4 μ s 100 = 3.2 μ s (default) 101 = 4.0 μ s 110 = 4.8 μ s 111 = stay "1"
HPC_600k<2:0>	6:4	Rx VGA highpass corner duration at 600kHz. Triggered by RXEN rising edge. Test at settings 000, 100, and 110. 000 = 0 μ s 001 = 0.8 μ s 010 = 1.6 μ s 011 = 2.4 μ s 100 = 3.2 μ s (default) 101 = 4.0 μ s 110 = 4.8 μ s 111 = stay "1"
HPC_10M_GAIN<1:0>	3:2	Rx VGA highpass corner duration at 10MHz. Triggered by LNA gain change. Test at settings 00, 01, and 11. 00 = 0 μ s 01 = 0.4 μ s 10 = 0.8 μ s 11 = 1.2 μ s (default)
HPC_10M<1:0>	1:0	Rx VGA highpass corner duration 10MHz. Triggered by RXEN rising edge. Test at settings 00 and 11. 00 = 0 μ s 01 = 0.4 μ s 10 = 0.8 μ s 11 = 1.2 μ s (default)

2.3GHz to 2.7GHz MIMO Wireless Broadband RF Transceiver

Table 16. Register 13: HPFSM 2 Register (Address = 01101, Default = 150HEX)

BIT NAME	BIT LOCATION (0 = LSB)	DESCRIPTION
HPC_1k<1:0>	9:8	Rx VGA highpass corner duration at 1kHz. Triggered by RXEN rising edge. Test at settings 00, 01, and 11. 00 = 0 μ s 01 = 3.2 μ s (default) 10 = 6.4 μ s 11 = 9.6 μ s
HPC_30k_GAIN<1:0>	7:6	Rx VGA highpass corner duration at 30kHz. Triggered by LNA gain change. Test at settings 00 and 01. 00 = 0 μ s 01 = 3.2 μ s (default) 10 = 6.4 μ s 11 = 9.6 μ s
HPC_30k<1:0>	5:4	Rx VGA highpass corner duration at 30kHz. Triggered by RXEN rising edge. Test at settings 00, 01, and 10. 00 = 0 μ s 01 = 3.2 μ s (default) 10 = 6.4 μ s 11 = 9.6 μ s
HPC_100k_GAIN<1:0>	3:2	Rx VGA highpass corner duration at 100kHz. Triggered by LNA gain change. Test at settings 00 and 11. 00 = 0 μ s (default) 01 = 3.2 μ s 10 = 6.4 μ s 11 = 9.6 μ s
HPC_100k<1:0>	1:0	Rx VGA highpass corner duration at 100kHz. Triggered by RXEN rising edge. Test at settings 00, 01, and 11. 00 = 0 μ s (default) 01 = 3.2 μ s 10 = 6.4 μ s 11 = 9.6 μ s

2.3GHz to 2.7GHz MIMO Wireless Broadband RF Transceiver

Table 17. Register 14: HPFSM 3 Register (Address = 01110, Default = 3C5HEX)

BIT NAME	BIT LOCATION (0 = LSB)	DESCRIPTION
TXGATE_EN	9	PA driver and DAC on/off state gated by PLL lock detect. 0 = Independent of PLL lock detect 1 = Disable PA driver when PLL lock detect = 0 (default)
RESERVED	8	Reserved bits—set to default
HPC_STOP_M2<1:0>	7:6	Rx VGA on-hold highpass corner when RXHP = 1. Test at settings 00, 01, and 11. Only active when Reg15_D9 = 1. 00 = 1kHz 01 = 30kHz 10 = 100kHz 11 = 600kHz (default)
HPC_STOP<1:0>	5:4	Rx VGA final highpass corner selection. Test at settings 00, 01, and 11. 00 = 100Hz (default) 01 = 1kHz 10 = 30kHz 11 = 100kHz
HPC_DELAY<1:0>	3:2	Rx VGA HPC _A and HPC _D rising edge delay for 100k, 30k, 1k, and 100Hz highpass corner. Test at settings 00, 01, and 11. 00 = 0μs 01 = 0.2μs (default) 10 = 0.4μs 11 = 0.6μs
HPC_1k_GAIN<1:0>	1:0	Rx VGA highpass corner duration at 1kHz. Triggered by LNA gain change. Test at settings 00, 01, and 10. 00 = 0μs 01 = 3.2μs (default) 10 = 6.4μs 11 = 9.6μs

Table 18. Register 15: HPFSM 4 Register (Address = 01111, Default = 201HEX)

BIT NAME	BIT LOCATION (0 = LSB)	DESCRIPTION
HP_MODE	9	Highpass corner control using RXHP. 0 = Highpass corner switches automatically without RXHP 1 = Highpass corner switches dependent on RXHP (default)
RESERVED	8:7	Reserved bits—set to default
HPC_SEQ_BYP	6	Highpass corner switching sequence bypassed during RXHP transition from 1 to 0. 0 = Start switching from highpass corner set by HPC_STOP_M2<1:0> in register 14 and continue with programmed sequence (default) 1 = Switch from highpass corner set by HPC_STOP_M2<1:0> directly to final highpass corner set by HPC_STOP<1:0> in register 14.
RESERVED	5:0	Reserved bits—set to default

2.3GHz to 2.7GHz MIMO Wireless Broadband RF Transceiver

Table 19. Register 16: BLK_SPI_EN Register (Address = 10000, Default = 01CHEX)

BIT NAME	BIT LOCATION (0 = LSB)	DESCRIPTION
RESERVED	9:8	Reserved bits—set to default
PADAC_TX_EN	7	PA bias DAC Tx mode enable bit. Enables PA bias DAC only in Tx mode. Turn-on delay is controlled by bits 9:6 of register 28. 0 = Disabled (default) 1 = Enabled when TXRX = 0
PADAC_SPI_EN	6	PA bias DAC SPI enable bit. Turn-on delay is controlled by bits 9:6 of register 28. 0 = Disabled (default) 1 = Enabled in all modes except for shutdown
RESERVED	5:2	Reserved bits—set to default
CAL_SPI	1	Receive and transmit calibration mode enable bit. Rx or Tx calibration mode is selected by TXRX pin. 0 = Normal receive or transmit mode (default) 1 = Calibration mode
EN_SPI	0	Transceiver enable bit. 0 = Disabled (default) 1 = Enabled. Enable pin must also be 1 to turn on transceiver.

Table 20. Register 17: FRAC_DIV_1 Register (Address = 10001, Default = 155HEX)

BIT NAME	BIT LOCATION (0 = LSB)	DESCRIPTION
SYN_CONFIG0<9:0>	9:0	Bits 9:0 of the 20-bit fractional divide ratio. The remaining bits 19:10 reside in register 18. Both registers are combined to form the 20-bit fractional word. Program register 17 to engage the stored values of registers 18 and 19.

Table 21. Register 18: FRAC_DIV_2 Register (Address = 10010, Default = 155HEX)

BIT NAME	BIT LOCATION (0 = LSB)	DESCRIPTION
SYN_CONFIG0<19:10>	9:0	Bits 19:10 of the 20-bit fractional divide ratio. The remaining bits 9:0 reside in register 17. Both registers are combined to form the 20-bit fractional word. Program register 18 before register 17.

2.3GHz to 2.7GHz MIMO Wireless Broadband RF Transceiver

Table 22. Register 19: INT_DIV Register (Address = 10011, Default = 153HEX)

BIT NAME	BIT LOCATION (0 = LSB)	DESCRIPTION
LOGEN_BSW<1:0>	9:8	LO generation band switch control for optimal transmit spur. 00 = 2300MHz to 2399.99MHz 01 = 2400MHz to 2499.99MHz (default) 10 = 2500MHz to 2599.99MHz 11 = 2600MHz to 2700MHz
SYN_CONFIG1<7:0>	7:0	Synthesizer 8-bit integer divide ratio. Program register 19 before register 17. Test at settings between 76 and 90 to support LO frequency between 2300MHz and 2700MHz.

Table 23. Register 20: SYNTH_CONFIG_1 Register (Address = 10100, Default = 249HEX)

BIT NAME	BIT LOCATION (0 = LSB)	DESCRIPTION
RESERVED	9:6	Reserved bits—set to default
CLKOUT_DRV	5	Reference clock output buffer drive selection. 0 = 1x drive (default) 1 = 4x drive
RESERVED	4:3	Reserved bits—set to default
SYN_CONFIG1<1:0>	2:1	Reference divide ratio selection. 00 = Divide by 1 (default) 01 = Divide by 2 10 = Divide by 4
RESERVED	0	Reserved bit—set to default

Table 24. Register 21: SYNTH_CONFIG_2 Register (Address = 10101, Default = 02DHEX)

BIT NAME	BIT LOCATION (0 = LSB)	DESCRIPTION
RESERVED	9:0	Reserved bits—set to default

Table 25. Register 22: VAS_CONFIG Register (Address = 10110, Default = 1A9HEX)

BIT NAME	BIT LOCATION (0 = LSB)	DESCRIPTION
RESERVED	9:1	Reserved bits—set to default
VAS_MODE	0	VCO autoselect (VAS) operating mode selection. 0 = Manually select VCO sub-band by SPI register 23 D[4:0] 1 = Select VCO sub-band automatically by VAS (default)

2.3GHz to 2.7GHz MIMO Wireless Broadband RF Transceiver

Table 26. Register 23: LO_MISC_CONFIG Register (Address = 10111, Default = 24F_{HEX})

BIT NAME	BIT LOCATION (0 = LSB)	DESCRIPTION
RESERVED	9:5	Reserved bits—set to default
VAS_SPI<4:0>	4:0	VCO autoselect (VAS) sub-band SPI overwrite. Active when register 22 D0 = 0. 00000 = Minimum frequency - sub-band 0 00001 = Sub-band 1 01111 = Sub-band 15 (default) 11110 = Sub band 30 11111 = Maximum frequency - sub-band 31

Table 27. Register 24: XTAL_CONFIG Register (Address = 11000, Default = 180_{HEX})

BIT NAME	BIT LOCATION (0 = LSB)	DESCRIPTION
RESERVED	9:7	Reserved bits—set to default
XTAL<6:0>	6:0	Crystal oscillator frequency tuning. 0000000 = Minimum frequency tuning (default) 1111111 = Maximum frequency tuning

Table 28. Register 25: VCO_CONFIG Register (Address = 11001, Default = 000_{HEX})

BIT NAME	BIT LOCATION (0 = LSB)	DESCRIPTION
RESERVED	9:0	Reserved bits—set to default

2.3GHz to 2.7GHz MIMO Wireless Broadband RF Transceiver

Table 29. Register 26: LOGEN_CONFIG Register (Address = 11010, Default = 3C0HEX)

BIT NAME	BIT LOCATION (0 = LSB)	DESCRIPTION
VAS_TST<3:0>	9:6	VCO autoselect (VAS) sub-band and VCO tune voltage test signal output select. Results are delivered to DOUT pin by setting register 9 D<7:5> = 010. VCO_BSW<4:0> = 5 VCO sub-band bits representing sub-band number 0 to 31. 0000 = VCO_BSW<0> 0001 = VCO_BSW<1> 0010 = VCO_BSW<2> 0011 = VCO_BSW<3> 0100 = VCO_BSW<4> VTUNE_ADC<2:0> = 3-bit ADC output representing VCO tune voltage. 0101 = VTUNE_ADC<0> 0110 = VTUNE_ADC<1> 0111 = VTUNE_ADC<2> 1111 = 0 (default)
RESERVED	5:4	Reserved bits—set to default
LOGEN_2GM	3	LO generation G _m enable. 0 = Function of TXRX and ENABLE pins (default) 1 = Enable both Rx/Tx output (required for Rx loopback calibration)
RESERVED	2:0	Reserved bits—set to default

Table 30. Register 27: TXLO_I/Q_CONFIG Register (Address = 11011, Default = 280HEX)

BIT NAME	BIT LOCATION (0 = LSB)	DESCRIPTION
RESERVED	9:8	Reserved bits—set to default
TXVGA_GAIN_SPI_EN	7	Transmit VGA gain control through SPI enable bit. 0 = Tx VGA gain control by pins B6:B1. 1 = Tx VGA gain control by register 29 D[5:0] (default)
RESERVED	6:0	Reserved bits—set to default

Table 31. Register 28: PA_BIAS_DAC Register (Address = 11100, Default = 0C0HEX)

BIT NAME	BIT LOCATION (0 = LSB)	DESCRIPTION
PADAC_DLY<3:0>	9:6	PA bias DAC turn-on delay control. 0000 = 0μs 0001 = 0μs 0010 = 0.5μs 0011 = 1.0μs (default) 1111 = 7.0μs
RESERVED	5:0	Reserved bits—set to default

2.3GHz to 2.7GHz MIMO Wireless Broadband RF Transceiver

Table 32. Register 29: TX_GAIN_CONFIG Register (Address = 11101, Default = 03F_{HEX})

BIT NAME	BIT LOCATION (0 = LSB)	DESCRIPTION
RESERVED	9:6	Reserved bits—set to default
TXVGA_GAIN_SPI<5:0>	5:0	<p>Tx VGA gain control through SPI. Active when register 27 D7 = 1. 000000 = 0dB attenuation (max gain) 000001 = Max - 1dB 011111 = Max - 31dB 111111 = Max - 63dB (default) Test at settings 000000, 000011, 001001, 001010, 011101, 011110, and 111111.</p>

Table 33. Register 30: TX_DC_CORR_1 Register (Address = 11110, Default = 380_{HEX})

BIT NAME	BIT LOCATION (0 = LSB)	DESCRIPTION
PADAC_VMODE	9	<p>PA DAC voltage mode output select Active when register 30 D8 = 0. 0 = Logic "0" output 1 = Logic "1" output (default)</p>
RESERVED	8:0	Reserved bits—set to default

Table 34. Register 31: TX_DC_CORR_2 Configuration Register (Address = 11111, Default = 340_{HEX})

BIT NAME	BIT LOCATION (0 = LSB)	DESCRIPTION
RESERVED	9:0	Reserved bits—set to default

2.3GHz to 2.7GHz MIMO Wireless Broadband RF Transceiver

Typical Operating Circuit

MAX2839AS

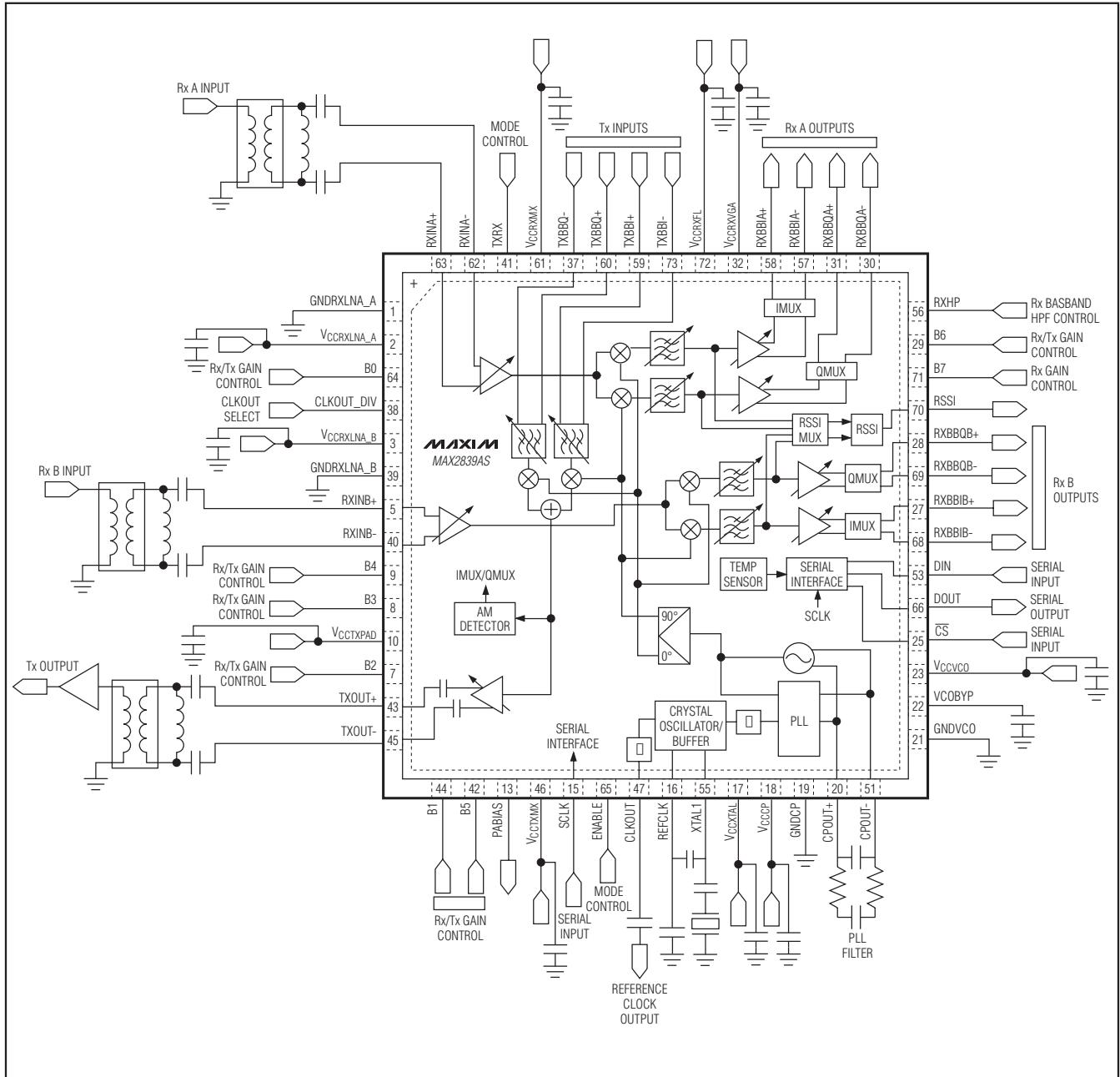

2.3GHz to 2.7GHz MIMO Wireless Broadband RF Transceiver

Bump Configuration

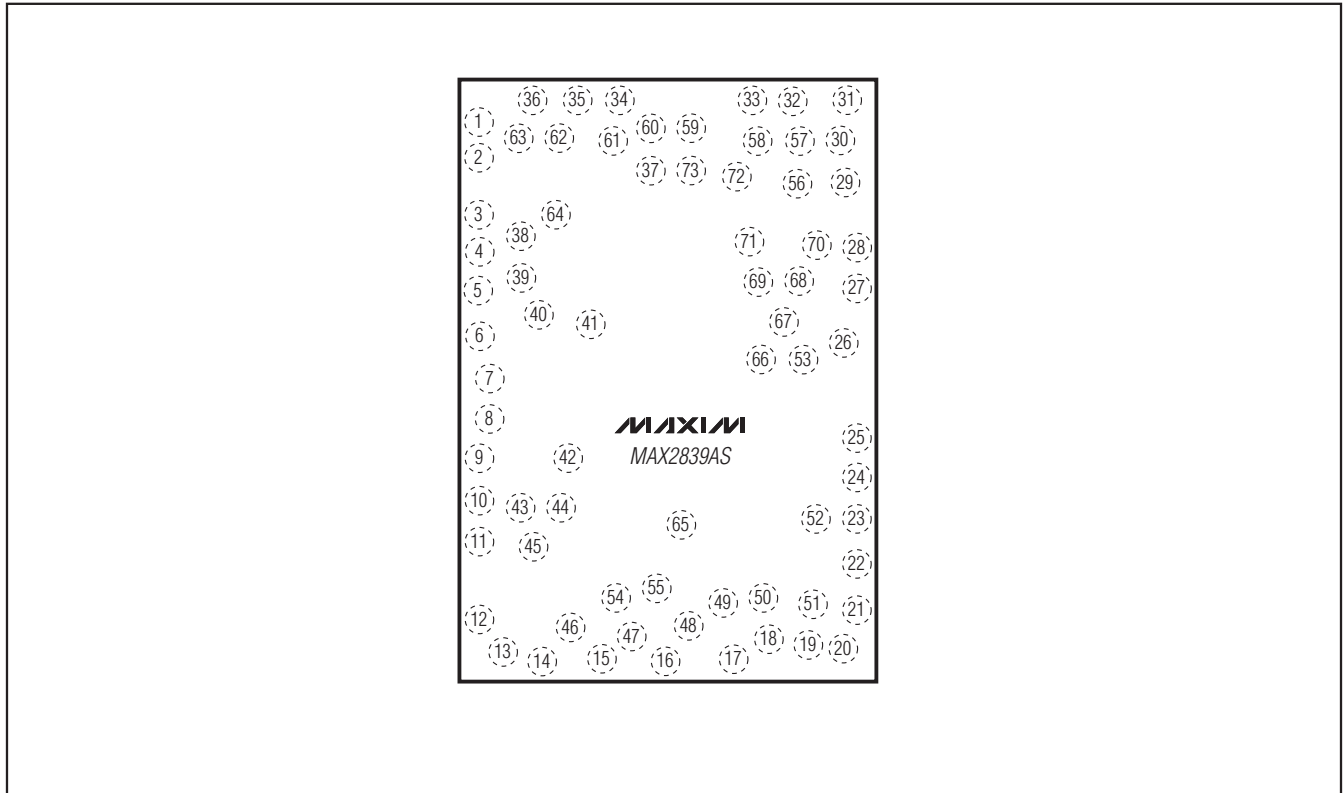

Chip Information

PROCESS: BICMOS

Package Information

For the latest package outline information and land patterns, go to www.maxim-ic.com/packages. Note that a "+", "#", or "-" in the package code indicates RoHS status only. Package drawings may show a different suffix character, but the drawing pertains to the package regardless of RoHS status.

PACKAGE TYPE	PACKAGE CODE	DOCUMENT NO.
73 WLP	W733A5+1	21-0146

2.3GHz to 2.7GHz MIMO Wireless Broadband RF Transceiver

Revision History

REVISION NUMBER	REVISION DATE	DESCRIPTION	PAGES CHANGED
0	4/09	Initial release	—
1	5/10	Added soldering temperature to <i>Absolute Maximum Ratings</i> ; corrected name in global references to MAX2839AS Evaluation Kit	2-18

MAX2839AS

Maxim cannot assume responsibility for use of any circuitry other than circuitry entirely embodied in a Maxim product. No circuit patent licenses are implied. Maxim reserves the right to change the circuitry and specifications without notice at any time.

Maxim Integrated Products, 120 San Gabriel Drive, Sunnyvale, CA 94086 408-737-7600 _____ **39**

Looking for pricing, stock, or lifecycle information?

Click below to explore more details on WIN SOURCE:

 [View MAX2839ASEWO+W on WIN SOURCE](#)

 [Maxim Integrated](#) Information

Optimize Your Supply Chain with WIN SOURCE Solutions

-  Global Sourcing Solution
-  Obsolete Management
-  Cost Control Management
-  Shortage Management
-  Alternative Solution
-  Excess Inventory Management