



**THE DATASHEET OF
MAX2693LEWS+T**



MAX2686L/MAX2693L

GPS/GNSS Low-Noise Amplifiers with Integrated LDO

General Description

The MAX2686L/MAX2693L low-noise amplifiers (LNAs) are designed for GPS L1, Galileo, and GLONASS applications. Designed in Maxim's advanced SiGe process, the devices achieve high gain and low noise figure while maximizing the input-referred 1dB compression point and the 3rd-order intercept point. Both devices include an internal LDO ideal for battery-powered applications. For current-sensitive applications, the MAX2693L achieves excellent performance while consuming only 1.8mA current.

The devices operate from a +1.6V to +4.2V single supply. The shutdown feature reduces the supply current to less than 20 μ A. The devices are available in a very small, lead-free, RoHS-compliant, 0.86mm x 0.86mm x 0.65mm wafer-level package (WLP).

Applications

- Telematics (Asset Tracking and Management)
- Cellular Phones with GPS
- Notebook PCs/Ultra-Mobile PCs
- Recreational, Marine Navigation
- Watches
- Digital Cameras

Benefits and Features

- High Power Gain: 19dB (MAX2686L)
- Low Noise Figure: 0.88dB (MAX2686L)
- Integrated 50 Ω Output Matching Circuit
- Low Supply Current: 1.8mA (MAX2693L)
- Wide Supply Voltage Range: 1.6V to 4.2V
- Low Bill of Materials: One Inductor, Two Capacitors
- Small Footprint: 0.86mm x 0.86mm
- 0.4mm Pitch WLP

Ordering Information appears at end of data sheet.

Typical Operating Circuit

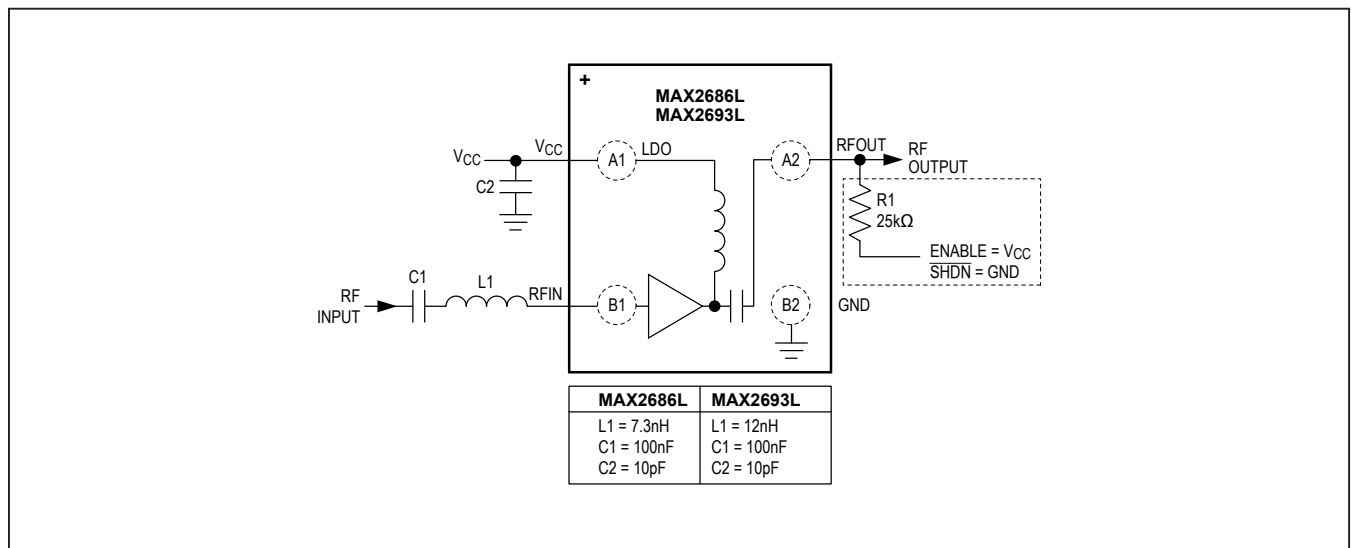

Absolute Maximum Ratings

V _{CC} to GND.....	-0.3V to +4.2V	Maximum Current into RF Input.....	10mA
Other Pins to GND.....	-0.3V to (+ Operating V _{CC} + 0.3V)	Operating Temperature Range.....	-40°C to +85°C
Maximum RF Input Power.....	+5dBm	Junction Temperature.....	+150°C
Continuous Power Dissipation (T _A = +70°C)		Storage Temperature Range.....	-65°C to +160°C
WLP (derates 9.7mW/°C above +70°C).....	776mW	Soldering Temperature (reflow) (Note 1).....	+260°C

Stresses beyond those listed under "Absolute Maximum Ratings" may cause permanent damage to the device. These are stress ratings only, and functional operation of the device at these or any other conditions beyond those indicated in the operational sections of the specifications is not implied. Exposure to absolute maximum rating conditions for extended periods may affect device reliability.

Note 1: Refer to Application Note 1891: *Wafer-Level Packaging (WLP) and Its Applications*.

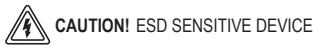

DC Electrical Characteristics

(MAX2686L/MAX2693L EV kit, V_{CC} = 1.6V to 4.2V, T_A = -40°C to +85°C, no RF signals are applied. Typical values are at V_{CC} = 3.3V and T_A = +25°C, unless otherwise noted.) (Note 2)

PARAMETER	CONDITIONS	MIN	TYP	MAX	UNITS
Supply Voltage		1.6	3.3	4.2	V
Supply Current	SHDN = high	MAX2686L		5	mA
		MAX2693L		1.8	
	Shutdown mode, V _{SHDN} = 0V				20
Digital Input Logic-High	(Note 3)	1.2			V
Digital Input Logic-Low	(Note 3)			0.45	V

AC Electrical Characteristics

(MAX2686L/MAX2693L EV kit, V_{CC} = 1.6V to 4.2V, T_A = -40°C to +85°C, f_{RFIN} = 1575.42MHz. Typical values are at V_{CC} = 3.3V and T_A = +25°C, unless otherwise noted.) (Note 2)

PARAMETER	CONDITIONS	MIN	TYP	MAX	UNITS
RF Frequency	L1 band	1575.42			MHz
Power Gain	V _{CC} = 4.2V (Note 4)	MAX2686L		14.65	dB
		MAX2693L		11.6	
	V _{CC} = 1.6V	MAX2686L		14.85	dB
		MAX2693L		11.6	
Noise Figure	V _{CC} = 1.6V to 4.2V	MAX2686L		0.88	dB
		MAX2693L		1.05	
In-Band 3rd-Order Input Intercept Point	(Note 5)	MAX2686L		-4.1	dBm
		MAX2693L		-14.3	
Out-of-Band 3rd-Order Input Intercept Point	(Note 6)	MAX2686L		-0.1	dBm
		MAX2693L		-13.9	
Input 1dB Compression Point	(Note 7)	MAX2686L		-12.1	dBm
		MAX2693L		-11.0	
Input Return Loss	MAX2686L		11.2		dB
	MAX2693L		10.7		

AC Electrical Characteristics (continued)

(MAX2686L/MAX2693L EV kit, $V_{CC} = 1.6V$ to $4.2V$, $T_A = -40^{\circ}C$ to $+85^{\circ}C$, $f_{RFIN} = 1575.42MHz$. Typical values are at $V_{CC} = 3.3V$ and $T_A = +25^{\circ}C$, unless otherwise noted.) (Note 2)

PARAMETER	CONDITIONS	MIN	TYP	MAX	UNITS
Output Return Loss	MAX2686L		22.0		dB
	MAX2693L		14.3		
Reverse Isolation	MAX2686L		41.0		dB
	MAX2693L		40.0		

Note 2: Min and max limits guaranteed by test at $T_A = +25^{\circ}C$ and guaranteed by design and characterization at $T_A = -40^{\circ}C$ and $T_A = +85^{\circ}C$, unless otherwise noted.

Note 3: Min and max limits guaranteed by test at $T_A = +25^{\circ}C$.

Note 4: Min limit guaranteed by design and characterization.

Note 5: Measured with the two tones located at 1MHz and 2MHz offset from the center of the GPS band with -30dBm/tone.

Note 6: Measured with input tones at 1713MHz (-27dBm) and 1851MHz (-39dBm).

Note 7: Measured with a tone located at the center of the GPS band.

Typical Operating Characteristics

(MAX2686L/MAX2693L EV kit. Typical values are at $V_{CC} = 3.3V$, $T_A = +25^{\circ}C$, and $f_{RFIN} = 1575.42MHz$, unless otherwise noted.)

MAX2686L

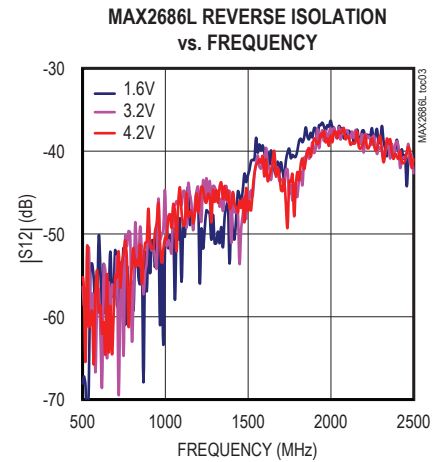
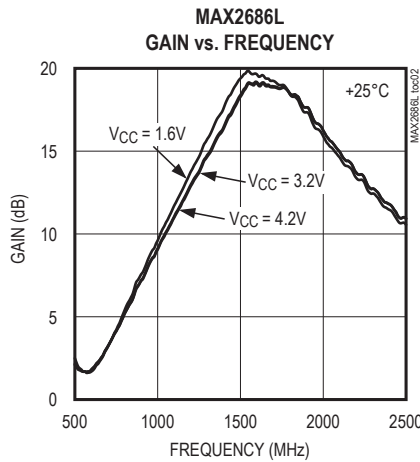
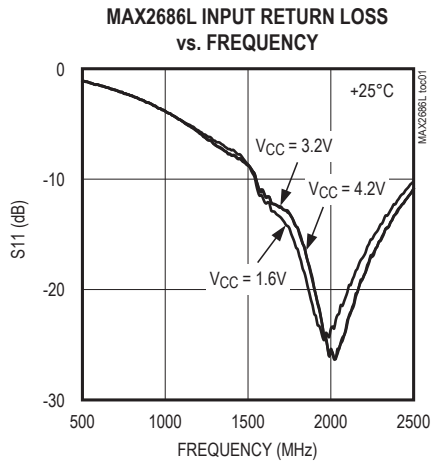

Typical Operating Characteristics (continued)

(MAX2686L/MAX2693L EV kit. Typical values are at $V_{CC} = 2.85V$, $T_A = +25^\circ C$, and $f_{RFIN} = 1575.42MHz$, unless otherwise noted.)

MAX2686L

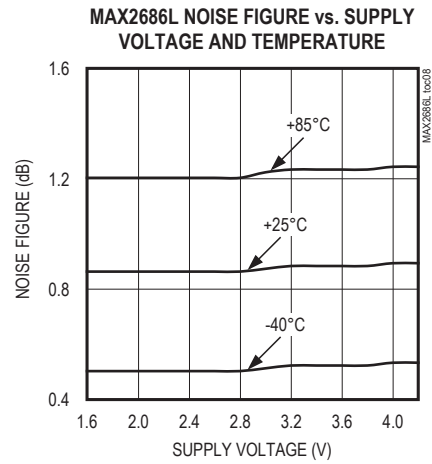
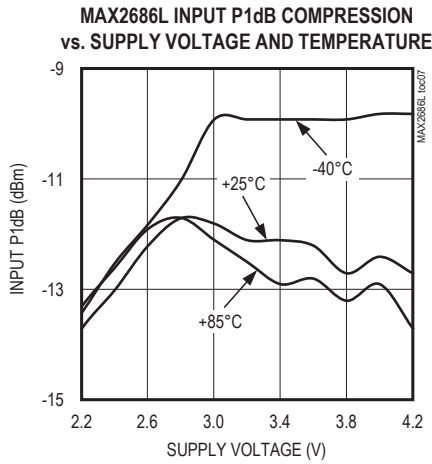
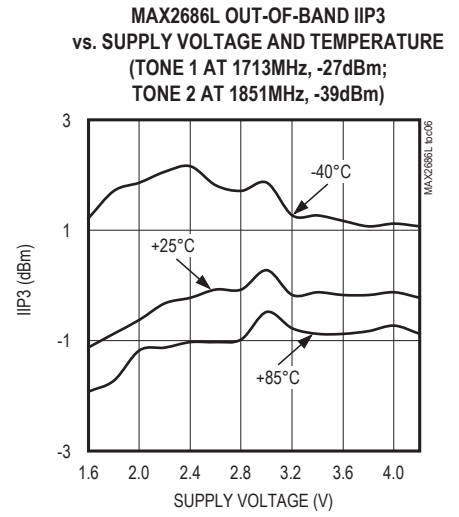
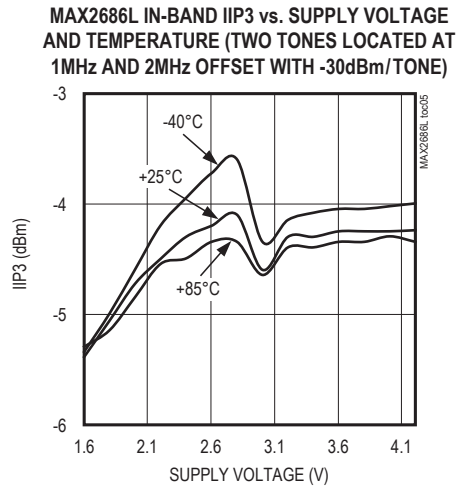
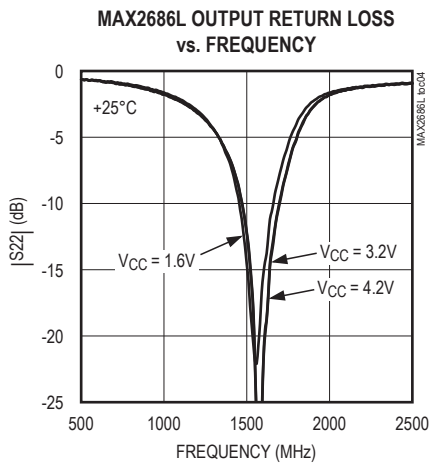

Typical Operating Characteristics (continued)

(MAX2686L/MAX2693L EV kit. Typical values are at $V_{CC} = 2.85V$, $T_A = +25^\circ C$, and $f_{RFIN} = 1575.42MHz$, unless otherwise noted.)

MAX2693L

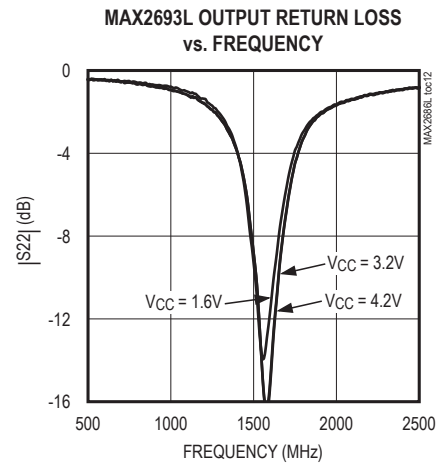
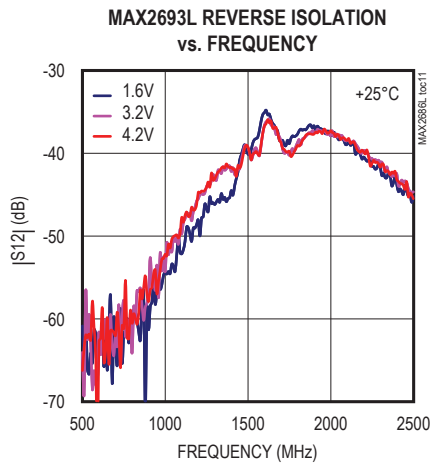
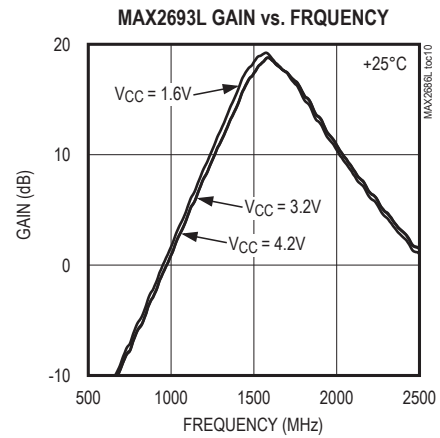
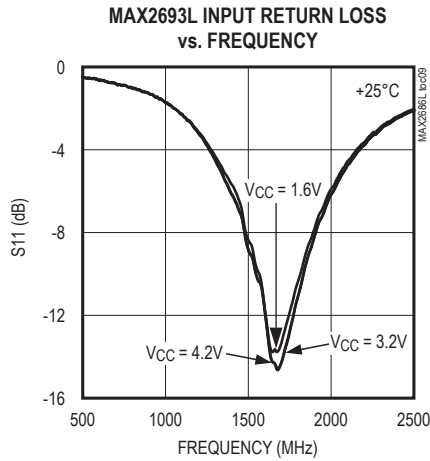

Typical Operating Characteristics (continued)

(MAX2686L/MAX2693L EV kit. Typical values are at $V_{CC} = 2.85V$, $T_A = +25^\circ C$, and $f_{RFIN} = 1575.42MHz$, unless otherwise noted.)

MAX2693L

MAX2693L IN-BAND IIP3 vs. SUPPLY VOLTAGE AND TEMPERATURE
(TWO TONES LOCATED AT 1MHz AND 2MHz OFFSET WITH -30dBm/TONE)

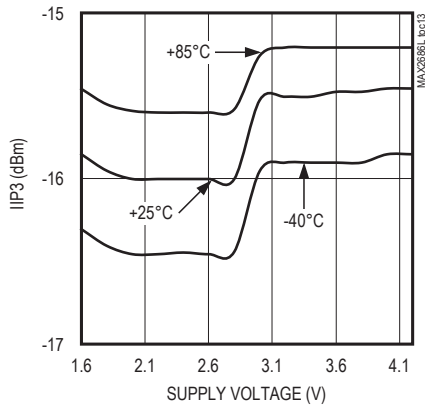

MAX2693L OUT-OF-BAND IIP3 vs. SUPPLY VOLTAGE AND TEMPERATURE
(TONE 1 AT 1713MHz, -27dBm; TONE 2 AT 1851MHz, -39dBm)

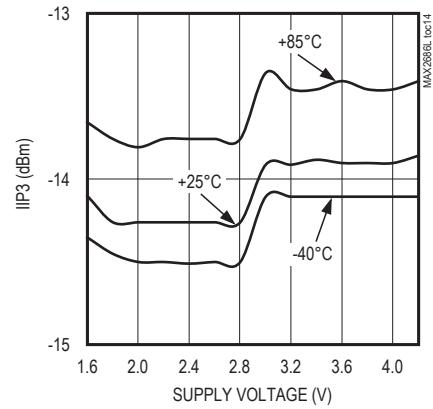

MAX2693L INPUT P1dB COMPRESSION vs. SUPPLY VOLTAGE AND TEMPERATURE

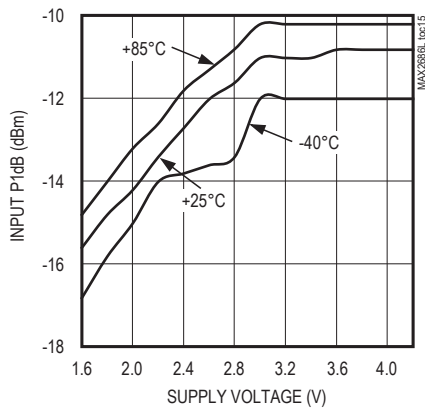

MAX2693L NOISE FIGURE vs. SUPPLY VOLTAGE AND TEMPERATURE

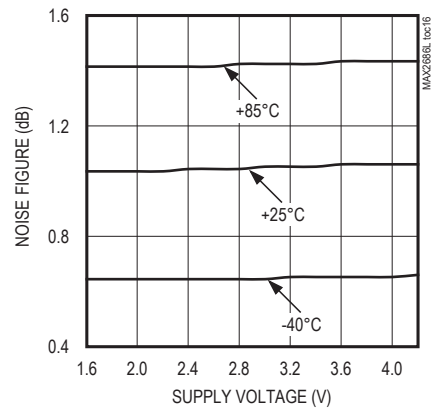

Bump Configuration

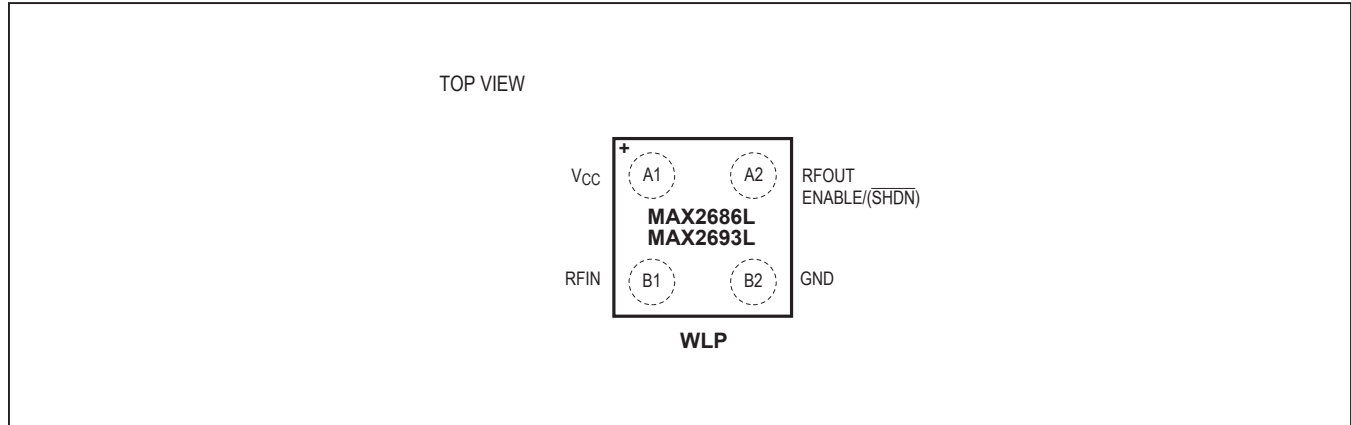

Bump Description

BUMP	NAME	FUNCTION
A1	V _{CC}	Supply Voltage. Bypass to ground with a 10pF capacitor as close as possible to the IC.
A2	RFOUT ENABLE/(SHDN)	RF Output. RFOUT is internally matched to 50Ω. Pulling the DC high through the 25kΩ resistor enables the IC. RFOUT(SHDN) can be pulled to a DC low through a 25kΩ resistor to shut down the IC.
B1	RFIN	RF Input. Requires a DC-blocking capacitor and external matching components.
B2	GND	Ground. Connect to the PCB ground plane.

Detailed Description

The MAX2686L/MAX2693L are LNAs designed for GPS L1, Galileo, and GLONASS applications. The devices feature an optional power-shutdown control mode to eliminate the need for an external supply switch. The devices achieve high gain and low noise figure in an ultra-small package ideal for space-sensitive applications. These integrated ICs eliminate the need for an external LDO.

Input and Output Matching

The devices require an off-chip input matching. Only an inductor in series with a DC-blocking capacitor is needed to form the input matching circuit. The *Typical Operating Circuit* shows the recommended input-matching network. These values are optimized for the best simultaneous gain, noise figure, and return loss performance. The value of the input coupling capacitor affects IIP3. A smaller

coupling capacitor results in lower IIP3. The devices integrate an on-chip output matching to 50Ω at the output, eliminating the need for external matching components. [Table 1](#) and [Table 2](#) list typical device S parameters and K_f values. Typical noise parameters are shown in [Table 3](#) and [Table 4](#).

ENABLE/(SHDN)

The devices include a shutdown feature to turn off the entire chip. The devices are placed in active mode by default once V_{CC} is applied, due to the off-chip pullup resistor to V_{CC} at the RFOUT bump. To shut down the part, apply a logic-low to the RFOUT bump through an external resistor with an adequate value, e.g., 25kΩ, in order not to load the RF output signal during active operation.

To enable the part, apply a logic-high to the RFOUT bump through the external 25kΩ resistor.

Table 1. MAX2686L Typical S Parameter Values and K-Factor

FREQ (MHz)	S11 MAG (dB)	S11 PHASE (DEGREES)	S21 MAG (dB)	S21 PHASE (DEGREES)	S12 MAG (dB)	S12 PHASE (DEGREES)	S22 MAG (dB)	S22 PHASE (DEGREES)	K _f
1000	-2.7	-88.3	7.9	162.0	-56.7	101.9	-1.9	-153.8	16.1
1100	-2.9	-95.0	9.6	150.5	-48.5	57.5	-2.4	-169.9	9.8
1200	-3.2	-101.7	11.2	136.9	-45.5	64.8	-3.1	172.8	7.4
1300	-3.4	-107.4	12.8	122.2	-49.2	51.0	-4.4	153.8	6.6
1400	-3.5	-113.3	14.4	104.8	-47.4	1.8	-6.8	132.5	6.9
1500	-3.3	-120.2	16.0	85.4	-50.7	19.3	-11.9	102.3	7.8
1575	-3.5	-125.7	16.8	66.9	-44.6	29.9	-26.0	46.7	5.9
1600	-3.7	-126.8	16.8	58.4	-43.4	15.5	-24.3	-79.5	5.1
1700	-3.6	-131.1	16.5	34.7	-49.8	-7.5	-10.1	-125.4	6.5
1800	-3.5	-139.0	16.1	12.9	-51.0	39.5	-5.4	-148.1	4.0
1900	-3.7	-146.3	15.2	-7.7	-41.9	7.5	-3.0	-169.7	2.2
2000	-4.0	-152.0	13.8	-24.4	-41.8	-10.7	-1.9	170.5	2.0

Table 2. MAX2693L Typical S Parameter Values and K-Factor

FREQ (MHz)	S11 MAG (dB)	S11 PHASE (DEGREES)	S21 MAG (dB)	S21 PHASE (DEGREES)	S12 MAG (dB)	S12 PHASE (DEGREES)	S22 MAG (dB)	S22 PHASE (DEGREES)	K _f
1000	-1.0	-77.4	-2.5	-148.6	-55.5	78.6	-0.9	-138.2	16.1
1100	-1.1	-84.8	0.1	-159.7	-51.0	85.5	-1.2	-154.2	9.8
1200	-1.2	-92.5	2.7	-172.2	-48.0	70.0	-1.6	-172.0	7.4
1300	-1.3	-99.4	5.6	171.7	-46.4	56.0	-2.3	167.2	6.6
1400	-1.5	-106.5	8.4	152.1	-45.9	35.6	-3.8	140.1	6.9
1500	-1.6	-113.2	11.0	124.7	-46.3	22.2	-8.0	96.8	7.8
1575	-1.6	-118.5	12.2	99.5	-44.0	38.3	-14.8	23.5	5.9
1600	-1.7	-120.6	12.3	88.4	-42.4	22.2	-14.9	-33.4	5.1
1700	-1.9	-126.6	11.5	55.8	-45.3	-9.5	-6.5	-117.5	6.5
1800	-1.8	-133.6	10.0	30.2	-43.6	12.4	-3.3	-152.3	4.0
1900	-2.0	-140.7	8.4	10.0	-40.1	-8.1	-2.0	-176.5	2.2
2000	-2.1	-146.9	6.9	-4.9	-39.6	-29.9	-1.5	164.9	2.0

Table 3. MAX2686L Simulated Typical Noise Parameters (V_{CC} = 3.3V, T_A = +25°C)

FREQUENCY (MHz)	FMIN (dB)	Γ _{OPT}	Γ _{OPT} ANGLE	R _N (Ω)
1550	0.70	0.43	45	8.45
1560	0.70	0.43	45	8.43
1570	0.70	0.42	45	8.42
1580	0.70	0.42	45	8.41
1590	0.70	0.42	46	8.39
1600	0.71	0.42	46	8.38

Table 4. MAX2693L Simulated Typical Noise Parameters ($V_{CC} = 3.3V$, $T_A = +25^\circ C$)

FREQUENCY (MHz)	FMIN (dB)	$ \Gamma_{OPT} $	$ \Gamma_{OPT} $ ANGLE	R_N (Ω)
1550	0.88	0.69	32	24.27
1560	0.88	0.69	32	24.22
1570	0.88	0.68	32	24.17
1580	0.88	0.68	32	24.12
1590	0.88	0.68	32	24.07
1600	0.88	0.68	33	24.03

Applications Information

A properly designed PCB is essential to any RF micro-wave circuit. Use controlled-impedance lines on all high-frequency inputs and outputs. Bypass V_{CC} with decoupling capacitors located close to the device. For long V_{CC} lines, it may be necessary to add decoupling capacitors. Locate these additional capacitors further away from the device package. Proper grounding of the GND bump is essential. If the PCB uses a topside RF ground, connect it directly to the GND bump. For a board where the ground is not on the component layer, connect the GND bump to the board with multiple vias close to the package. For general layout guidelines, refer to www.maximintegrated.com/app-notes/index.mvp/id/5100.

Refer to www.maximintegrated.com/datasheet/index.mvp/id/6934/t/do for the MAX2686L/MAX2693L EV kit schematic, Gerber data, PADS layout file, and BOM information.

Ordering Information

PART	TEMP RANGE	PIN-PACKAGE
MAX2686LEWS+T	-40°C to +85°C	4 WLP
MAX2693LEWS+T	-40°C to +85°C	4 WLP

+Denotes a lead(Pb)-free/RoHS-compliant package.

T = Tape and reel

Chip Information

PROCESS: BiCMOS

Package Information

For the latest package outline information and land patterns (footprints), go to www.maximintegrated.com/packages. Note that a "+", "#", or "-" in the package code indicates RoHS status only. Package drawings may show a different suffix character, but the drawing pertains to the package regardless of RoHS status.

PACKAGE TYPE	PACKAGE CODE	OUTLINE NO.	LAND PATTERN NO.
4 WLP	W40A0+1	21-0480	Refer to Application Note 1891

Revision History

REVISION NUMBER	REVISION DATE	DESCRIPTION	PAGES CHANGED
0	3/12	Initial release	—
1	2/15	Updated <i>Typical Operating Circuit</i> , <i>Bump Description</i> , and <i>Detailed Description</i> to show that the external resistor is now required and not optional	1, 7

For pricing, delivery, and ordering information, please contact Maxim Direct at 1-888-629-4642, or visit Maxim Integrated's website at www.maximintegrated.com.

Maxim Integrated cannot assume responsibility for use of any circuitry other than circuitry entirely embodied in a Maxim Integrated product. No circuit patent licenses are implied. Maxim Integrated reserves the right to change the circuitry and specifications without notice at any time. The parametric values (min and max limits) shown in the Electrical Characteristics table are guaranteed. Other parametric values quoted in this data sheet are provided for guidance.

Looking for pricing, stock, or lifecycle information?

Click below to explore more details on WIN SOURCE:

- ⊖ [View MAX2693LEWS+T on WIN SOURCE](#)
- ⊖ [Maxim Integrated Information](#)

Optimize Your Supply Chain with WIN SOURCE Solutions

- ✓ Global Sourcing Solution
- ✓ Obsolete Management
- ✓ Cost Control Management
- ✓ Shortage Management
- ✓ Alternative Solution
- ✓ Excess Inventory Management