

MAX200–MAX209/ MAX211/MAX213

+5V, RS-232 Transceivers with 0.1µF External Capacitors

General Description

MAX200-MAX209, MAX211, and MAX213 are a family of RS-232 and V.28 transceivers with integrated charge pump circuitry for single +5V supply operation.

The drivers maintain the ±5V EIA/TIA-232E output signal levels at data rates in excess of 120kbps when loaded in accordance with the EIA/TIA-232E specification.

The MAX211 and MAX213 are available in a 28-pin, wide small-outline (SO) package and a 28-pin shrink small-outline (SSOP) package, which occupies only 40% of the area of the SO. The MAX207 is available in a 24-pin SO package and a 24-pin SSOP. The MAX203 and MAX205 use no external components and are recommended for applications with limited circuit board space.

Benefits and Features

- Saves Board Space
 - Integrated Charge Pump Circuitry
 - Eliminates the Need for a Bipolar ±12V Supply
 - Enables Single Supply Operation From Either +5V or 9V to +12V
 - Integrated 0.1µF Capacitors (MAX203, MAX205)
 - 24 pin SSOP Package Saves Up to 40% Versus SO Package
- Saves Power for Longer Battery Operation
 - 5µW Shutdown Mode (MAX200, MAX205, MAX206, MAX211)
 - 75µW Ring Indicator Monitoring with Two Active Receivers (MAX213)

Applications

- Battery-Powered Equipment
- Handheld Equipment
- Portable Diagnostics Equipment

Typical Operating Circuit



Selector Guide

PART	POWER-SUPPLY VOLTAGE (V)	NUMBER OF RS-232 DRIVERS	NUMBER OF RS-232 RECEIVERS	NUMBER OF RECEIVERS ACTIVE IN SHUTDOWN	NUMBER OF EXTERNAL CAPACITORS (0.1µF)	LOW-POWER SHUTDOWN/TTL THREE-STATE
MAX200	+5	5	0	0	4	Yes/No
MAX201	+5 and +9.0 to +13.2	2	2	0	2	No/No
MAX202	+5	2	2	0	4	No/No
MAX203	+5	2	2	0	None	No/No

Selector Guide continued at end of data sheet.



Absolute Maximum Ratings

V _{CC}	-0.3V to +6V	20-Pin Wide SO (derate 10.00mW/°C above +70°C) ..800mW
V+	(V _{CC} - 0.3V) to +14V	20-Pin CERDIP (derate 11.11mW/°C above +70°C)...889mW
V-	+0.3V to -14V	24-Pin Narrow Plastic DIP
Input Voltages		(derate 13.33mW/°C above +70°C) 1067mW
T _{IN}	-0.3V to (V _{CC} + 0.3V)	24-Pin Wide Plastic DIP
R _{IN}	±30V	(derate 9.09mW/°C above +70°C)727mW
Output Voltages		24-Pin Wide SO (derate 11.76mW/°C above +70°C)..941mW
T _{OUT}	(V+ + 0.3V) to (V- - 0.3V)	24-Pin SSOP (derate 8.00mW/°C above +70°C).....640mW
R _{OUT}	-0.3V to (V _{CC} + 0.3V)	24-Pin CERDIP (derate 12.50mW/°C above +70°C) ... 1000mW
Short-Circuit Duration		28-Pin Wide SO (derate 12.50mW/°C above +70°C) ..1000mW
T _{OUT}	Continuous	28-Pin SSOP (derate 9.52mW/°C above +70°C).....762mW
Continuous Power Dissipation (T _A = +70°C)		Operating Temperature Ranges
14-Pin Plastic DIP (derate 10.00mW/°C above +70°C) ... 800mW		MAX2__C__
16-Pin Plastic DIP (derate 10.53mW/°C above +70°C) ... 842mW		MAX2__E__
16-Pin SO (derate 8.70mW/°C above +70°C).....696mW		MAX2__M__
16-Pin Wide SO (derate 9.52mW/°C above +70°C) ... 762mW		Storage Temperature Range
16-Pin CERDIP (derate 10.00mW/°C above +70°C) 800mW		Lead Temperature (soldering, 10s) (Note 1)
20-Pin Plastic DIP (derate 11.11mW/°C above +70°C) ... 889mW		

Note 1: Maximum reflow temperature for the MAX203 and MAX205 is +225°C.

Stresses beyond those listed under "Absolute Maximum Ratings" may cause permanent damage to the device. These are stress ratings only, and functional operation of the device at these or any other conditions beyond those indicated in the operational sections of the specifications is not implied. Exposure to absolute maximum rating conditions for extended periods may affect device reliability.

Electrical Characteristics

(MAX202/MAX204/MAX206/MAX208/MAX211/MAX213: V_{CC} = +5V ±10%; MAX200/MAX203/MAX205/MAX207: V_{CC} = +5V ±5%, C1–C4 = 0.1µF; MAX201/MAX209: V_{CC} = +5V ±10%, V+ = +9.0V to +13.2V, T_A = T_{MIN} to T_{MAX}, unless otherwise noted.)

PARAMETER	CONDITIONS	MIN	TYP	MAX	UNITS	
Output-Voltage Swing	All transmitter outputs loaded with 3kΩ to ground	±5	±8		V	
V _{CC} Power-Supply Current	No load, T _A = +25°C	MAX202, MAX203		8	15	mA
		MAX200, MAX204–MAX208, MAX211, MAX213		11	20	
		MAX201, MAX209		0.4	1	
V+ Power-Supply Current	No load	MAX201		5	10	mA
		MAX209		7	15	
Shutdown Supply Current	Figure 1, T _A = +25°C	MAX200, MAX205, MAX206, MAX211		1	10	µA
		MAX213		15	50	
Input Logic Threshold Low	T _{IN} , \overline{EN} , \overline{SHDN} , EN, \overline{SHDN}			0.8	V	
Input Logic Threshold High	T _{IN}			2.0	V	
	\overline{EN} , \overline{SHDN} , EN, \overline{SHDN}			2.4		
Logic Pullup Current	T _{IN} = 0V		15	200	µA	
RS-232 Input-Voltage Operating Range		-30		+30	V	

Electrical Characteristics (continued)

(MAX202/MAX204/MAX206/MAX208/MAX211/MAX213: $V_{CC} = +5V \pm 10\%$; MAX200/MAX203/MAX205/MAX207: $V_{CC} = +5V \pm 5\%$, C_1 – $C_4 = 0.1\mu F$; MAX201/MAX209: $V_{CC} = +5V \pm 10\%$, $V_+ = +9.0V$ to $+13.2V$, $T_A = T_{MIN}$ to T_{MAX} , unless otherwise noted.)

PARAMETER	CONDITIONS		MIN	TYP	MAX	UNITS
Receiver Input Threshold Low	$V_{CC} = +5V$, $T_A = +25^\circ C$	Active mode	0.8	1.2		V
		Shutdown mode, MAX213, R4, R5	0.6	1.5		
Receiver Input Threshold High	$V_{CC} = +5V$, $T_A = +25^\circ C$	Active mode		1.7	2.4	V
		Shutdown mode, MAX213, R4, R5		1.5	2.4	
RS-232 Input Hysteresis	$V_{CC} = +5V$, no hysteresis in shutdown		0.2	0.5	1.0	V
RS-232 Input Resistance	$V_{CC} = +5V$, $T_A = +25^\circ C$		3	5	7	kΩ
TTL/CMOS Output-Voltage Low	$I_{OUT} = 3.2mA$	MAX201, MAX202, MAX203			0.4	V
	$I_{OUT} = 1.6mA$	All others				
TTL/CMOS Output-Voltage High	$I_{OUT} = 1.0mA$		3.5			V
TTL/CMOS Output Leakage Current	$\overline{EN} = V_{CC}$, $EN = 0V$, $0 \leq R_{OUT} \leq V_{CC}$			0.05	±10	µA
Output Enable Time	Figure 2	MAX205, MAX206, MAX209, MAX211, MAX213		600		ns
Output Disable Time	Figure 2	MAX205, MAX206, MAX209, MAX211, MAX213		200		ns
Receiver Propagation Delay	$\overline{SHDN} = 0V$, R4, R5	MAX213		4	40	µs
			$\overline{SHDN} = V_{CC}$		0.5	
	MAX200–MAX211			0.5	10	
Transmitter Output Resistance	$V_{CC} = V_+ = V_- = 0V$, $V_{OUT} = \pm 2V$		300			Ω
Transition Region Slew Rate	$C_L = 50pF$ to $2500pF$, $R_L = 3k\Omega$ to $7k\Omega$, $V_{CC} = 5V$, $T_A = +25^\circ C$ measured from $+3V$ to $-3V$ or $-3V$ to $+3V$	MAX200, MAX202–MAX211, MAX213	3	5.5	30	V/µs
		MAX201		4	30	
RS-232 Output Short-Circuit Current				±10	±60	mA
Maximum Data Rate	$R_L = 3k\Omega$ to $7k\Omega$, $C_L = 50pF$ to $1000pF$, one transmitter		120			kbps

MAX200–MAX209/ MAX211/MAX213

+5V, RS-232 Transceivers with 0.1µF External Capacitors

Typical Operating Characteristics

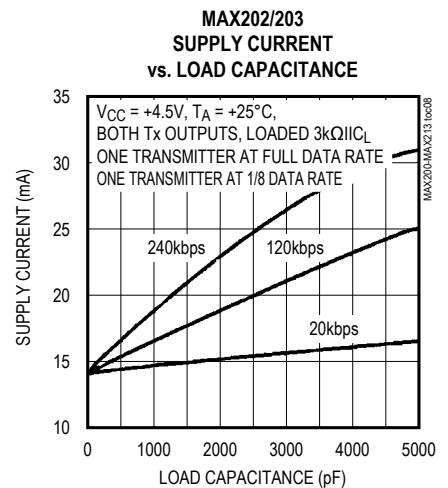
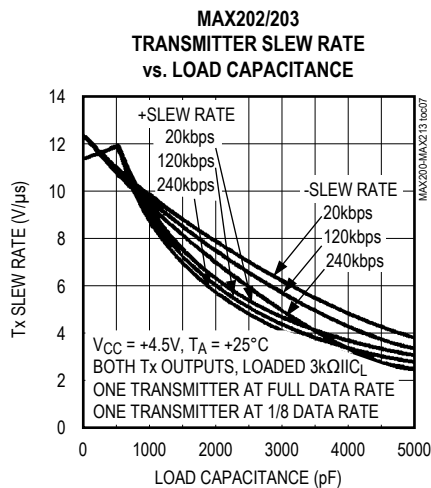
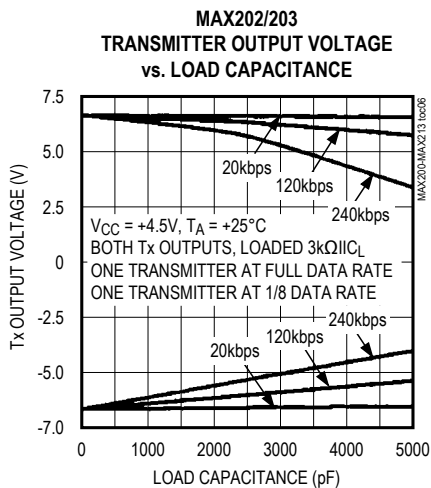
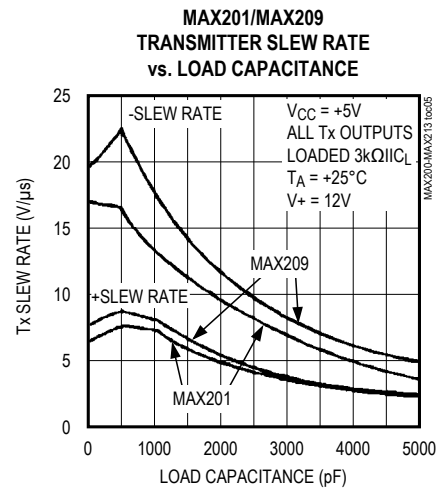
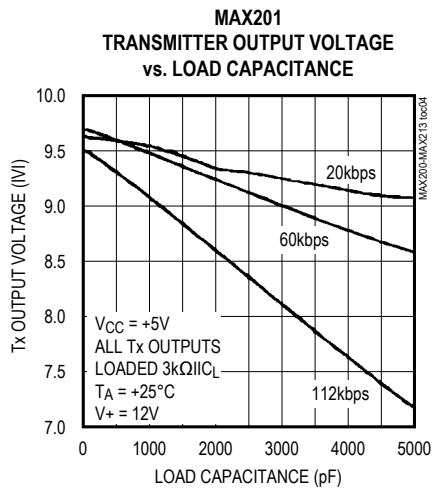
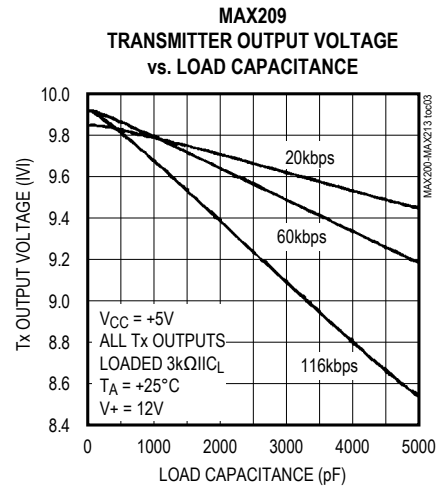
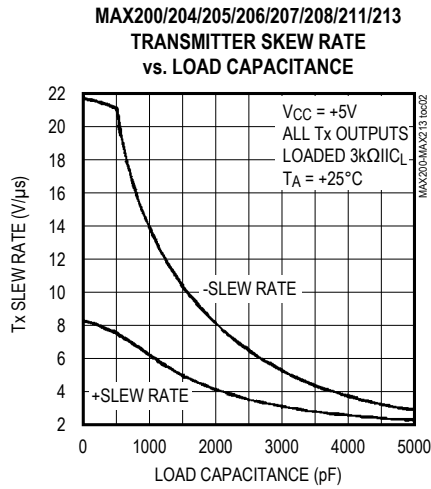
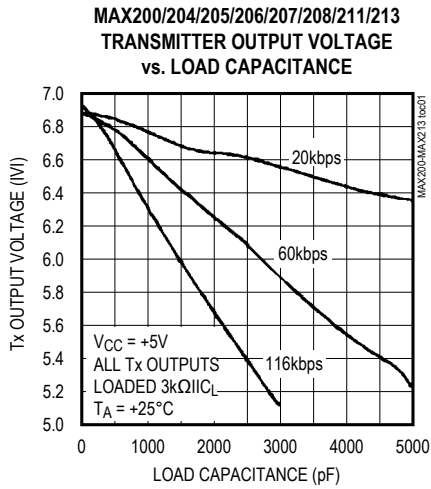



Figure 1. Shutdown Current Test Circuit



Figure 2. Receiver Output Enable and Disable Timing

Detailed Description

The MAX200–MAX209/MAX211/MAX213 consist of three sections: charge-pump voltage converters, drivers (transmitters), and receivers. Each section is described in detail.

+5V to ±10V Dual Charge-Pump Voltage Converter

The +5V to ±10V conversion is performed by two charge-pump voltage converters (Figure 4). The first uses capacitor C1 to double +5V to +10V, storing +10V on the V+ output filter capacitor, C3. The second charge-pump voltage converter uses capacitor C2 to invert +10V to -10V, storing -10V on the V- output filter capacitor, C4.

The MAX201 and MAX209 include only the V+ to Vcharge pump, and are intended for applications that have a VCC = +5V supply and a V+ supply in the +9V to +13.2V range.

In shutdown mode, V+ is internally connected to VCC by a 1kΩ pulldown resistor and V- is internally connected to ground by a 1kΩ pullup resistor.

RS-232 Drivers

When VCC = +5V, the typical driver output-voltage swing is ±8V when loaded with a nominal 5kΩ RS-232 receiver. The output swing is guaranteed to meet the EIA/TIA-232E and V.28 specifications, which call for ±5V minimum output levels under worst-case conditions. These include a minimum 3kΩ load, VCC = +4.5V, and the maximum operating temperature. The open-circuit output-voltage swing ranges from (V+ - 0.6V) to V-.

Input thresholds are both CMOS and TTL compatible. The inputs of unused drivers can be left unconnected since 400kΩ pullup resistors to VCC are included onchip. Since all drivers invert, the pullup resistors force the outputs of unused drivers low. The input pullup resistors typically source 15μA; therefore, the driver inputs should be driven high or open circuited to minimize power-supply current in shutdown mode.

When in low-power shutdown mode, the driver outputs are turned off and their leakage current is less than 1mA, even if the transmitter output is backdriven between 0V and (VCC + 6V). Below -0.5V, the transmitter output is diode clamped to ground with a 1kΩ series impedance. The transmitter output is also zener clamped to approximately (VCC + 6V), with a 1kΩ series impedance.



Figure 3. Transition Slew-Rate Test Circuit

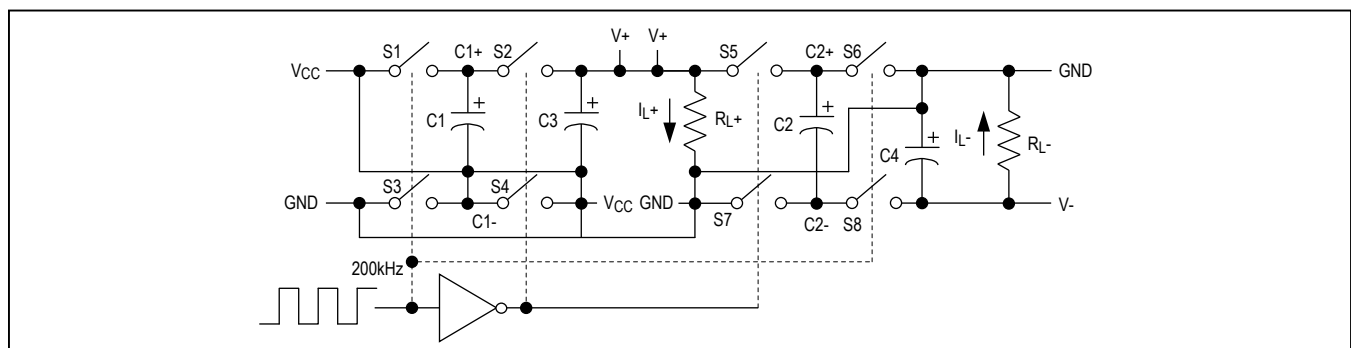

Figure 4. Dual Charge-Pump Diagram

RS-232 Receivers

The receivers convert RS-232 signals to CMOS logic output levels. Receiver outputs are inverting, maintaining compatibility with driver outputs. The guaranteed receiver input thresholds of +0.8V and +2.4V are significantly tighter than the ±3.0V threshold required by the EIA/TIA-232E specification. This allows receiver inputs to respond to TTL/CMOS logic levels and improves noise margin for RS-232 levels.

The MAX200–MAX209/MAX211/MAX213 guaranteed +0.8V threshold (+0.6V in shutdown for the MAX213) ensures that receivers shorted to ground have a logic 1 output. Also, the 5kΩ input resistance to ground ensures that a receiver with its input left open also has a logic 1 output.

Receiver inputs have approximately +0.5V hysteresis. This provides clean output transitions, even with slow rise and fall time input signals with moderate amounts of noise and ringing. In shutdown, the MAX213 receivers R4 and R5 have no hysteresis.



Figure 5. Transmitter Outputs When Exiting Shutdown

Shutdown and Enable Control

In shutdown mode, the MAX200/MAX205/MAX206/MAX211/MAX213 charge pumps are turned off, V+ is pulled down to V_{CC}, V- is pulled to ground, and the transmitter outputs are disabled. This reduces supply current

typically to 1µA (15µA for the MAX213). The time required to exit shutdown is 1ms, as shown in Figure 5.

All receivers except R4 and R5 on the MAX213 are put into a high-impedance state in shutdown mode. The MAX213's R4 and R5 receivers still function in shutdown mode. These two receivers are useful for monitoring external activity while maintaining minimal power consumption.

The enable control is used to put the receiver outputs into a high-impedance state, so that the receivers can be connected directly to a three-state bus. It has no effect on the RS-232 drivers or on the charge pumps.

MAX213 Receiver Operation in Shutdown

During normal operation, the MAX213's receiver propagation delay is typically 1µs. When entering shutdown with receivers active, R4 and R5 are not valid until 80µs after $\overline{\text{SHDN}}$ is driven low. In shutdown mode, propagation delays increase to 4µs for a high-to-low or a low-to-high transition.

When exiting shutdown, all receiver outputs are invalid until the charge pumps reach nominal values (< 2ms when using 0.1µF capacitors).

Table 1a. MAX200 Control Pin Configurations

SHDN	OPERATION STATUS	TRANSMITTERS T1–T5
0	Normal Operation	All Active
1	Shutdown	All High-Z

Table 1b. MAX205/MAX206/MAX211 Control Pin Configurations

SHDN	$\overline{\text{EN}}$	OPERATION STATUS	TRANSMITTERS T1–T5	RECEIVERS R1–R5
0	0	Normal Operation	All Active	All Active
0	1	Normal Operation	All Active	All High-Z
1	0	Shutdown	All High-Z	All High-Z

Table 1c. MAX213 Control Pin Configurations

$\overline{\text{SHDN}}$	EN	OPERATION STATUS	TRANSMITTERS T1–T4	RECEIVERS	
				R1, R2, R3	R4, R5
0	0	Shutdown	All High-Z	High-Z	High-Z
0	1	Shutdown	All High-Z	High-Z	Active*
1	0	Normal Operation	All Active	High-Z	High-Z
1	1	Normal Operation	All Active	Active	Active

*Active = active with reduced performance.

Applications Information

Capacitor Selection

The type of capacitor used is not critical for proper operation. Ceramic capacitors are suggested. To ensure proper RS-232 signal levels over temperature when using 0.1µF capacitors, make sure the capacitance value does not degrade excessively as the temperature varies. If in doubt, use capacitors with a larger nominal value. Also observe the capacitors' ESR value over temperature, since it influences the amount of ripple on V+ and V-. To reduce the output impedance at V+ and V-, use larger capacitors (up to 10µF). If polarized capacitors are used, obey the polarities shown in Figure 1 and the pin configurations.

Driving Multiple Receivers

Each transmitter is designed to drive a single receiver. Transmitters can be paralleled to drive multiple receivers.

Driver Outputs When Exiting Shutdown

Figure 5 shows two driver outputs exiting shutdown. As they become active, the two driver outputs go to opposite RS-232 levels (one driver input is high, the other is low). Each driver is loaded with 3kΩ in parallel with 2500pF. The driver outputs display no ringing or undesirable transients as they come out of shutdown.

Power-Supply Decoupling

In applications that are sensitive to power-supply noise, decouple V_{CC} to ground with a capacitor of the same value as the charge-pump capacitors.

V+ and V- as Power Supplies

A small amount of power can be drawn from V+ and V-, although this reduces noise margins.

Power Supplies for MAX201/MAX209

If at power-up the V+ supply rises after the V_{CC} supply, place a diode (e.g., 1N914) in series with the V+ supply.

Table 2. Summary of EIA/TIA-232E, V.28 Specifications

PARAMETER	CONDITION	EIA/TIA-232E, V.28 SPECIFICATION
Driver Output Voltage: 0 Level	3kΩ to 7kΩ load	+5.0V to +15V
Driver Output Voltage: 1 Level	3kΩ to 7kΩ load	-5.0V to -15V
Output Level, Maximum	No load	±25V
Data Rate	3kΩ ≤ R _L ≤ 7kΩ, C _L ≤ 2500pF	Up to 20kbps
Receiver Input Voltage: 0 Level	—	+3.0V to +15V
Receiver Input Voltage: 1 Level	—	-3.0V to -15V
Input Level, Maximum	—	±25V
Instantaneous Slew Rate, Maximum	3kΩ ≤ R _L ≤ 7kΩ, C _L ≤ 2500pF	30V/µs
Driver Output Short-Circuit Current, Maximum	—	100mA
Transition Rate on Driver Output	V.28	1ms or 3% of the period
	EIA/TIA-232E	4% of the period
Driver Output Resistance	-2V < V _{OUT} < +2V	300Ω

Table 3. DB9 Cable Connections Commonly Used for EIA/TIA-232E and V.24 Asynchronous Interfaces

PIN	NAME	CONNECTION
1	Received Line Signal Detector, sometimes called Carrier Detect (DCD)	Handshake from DCE
2	Receive Data (RD)	Data from DCE
3	Transmit Data (TD)	Data from DTE
4	Data Terminal Ready	Handshake from DTE
5	Signal Ground	Reference point for signals
6	Data Set Ready (DSR)	Handshake from DCE
7	Request to Send (RTS)	Handshake from DTE
8	Clear to Send (CTS)	Handshake from DCE
9	Ring Indicator	Handshake from DCE

MAX200 Pin Configuration/Typical Operating Circuit



MAX201 Pin Configurations/Typical Operating Circuit

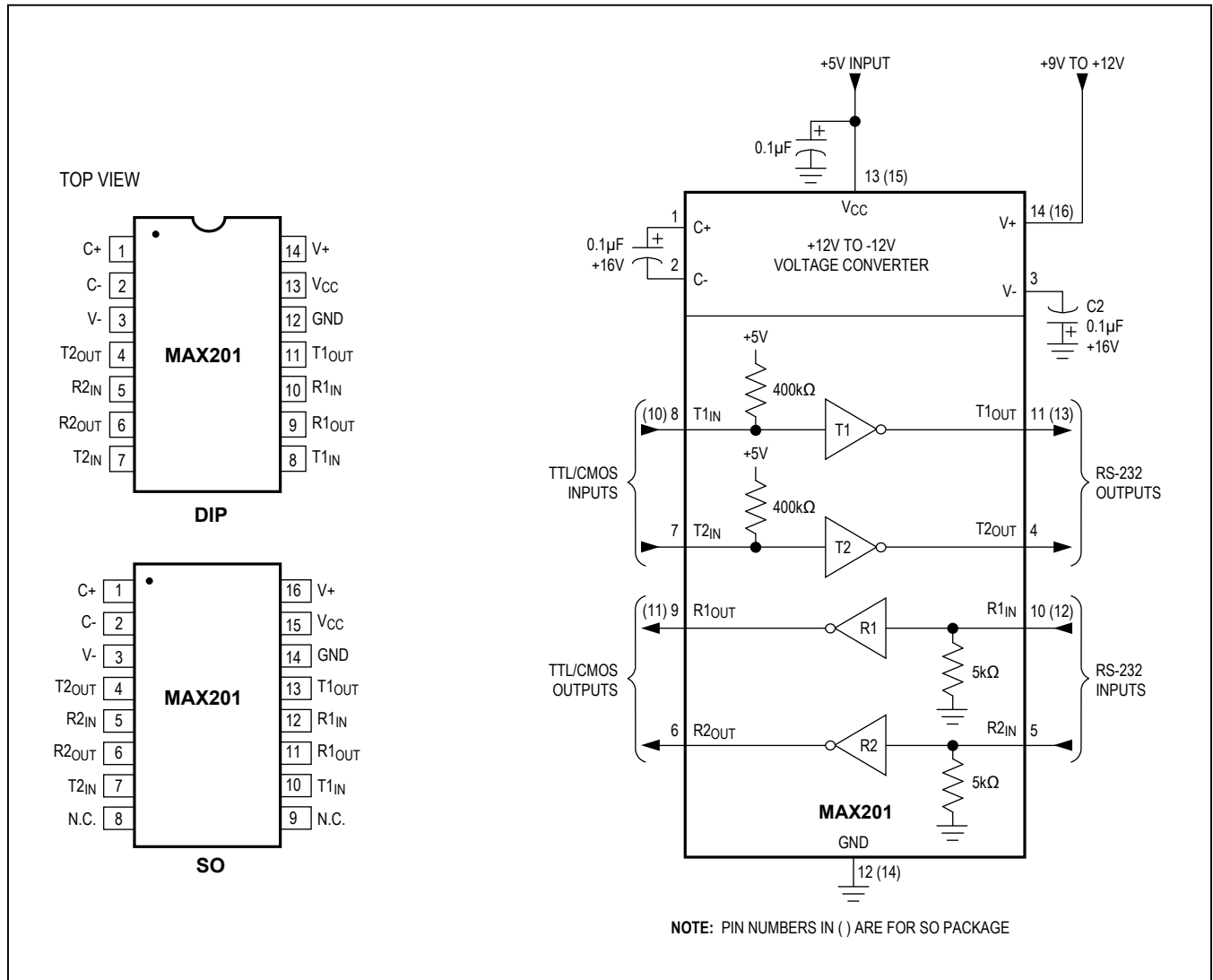

MAX202 Pin Configuration/Typical Operating Circuit



MAX203 Pin Configurations/Typical Operating Circuit



MAX204 Pin Configuration/Typical Operating Circuit



MAX205 Pin Configuration/Typical Operating Circuit

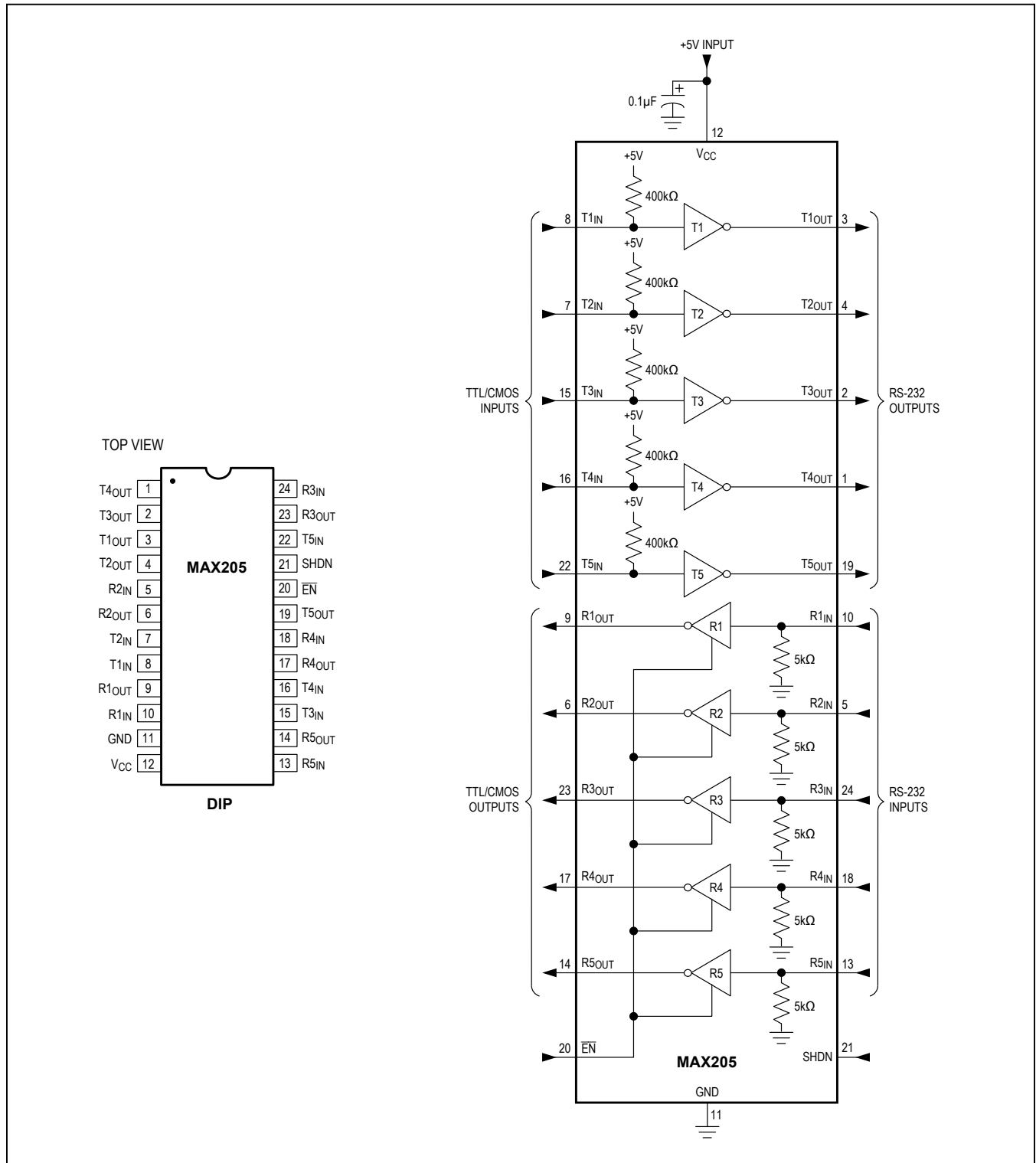

MAX206 Pin Configuration/Typical Operating Circuit



MAX207 Pin Configuration/Typical Operating Circuit



MAX209 Pin Configuration/Typical Operating Circuit



MAX211 Pin Configuration/Typical Operating Circuit



MAX213 Pin Configuration/Typical Operating Circuit



Ordering Information

PART	TEMP RANGE	PIN-PACKAGE
MAX200 CPP	0°C to +70°C	20 Plastic DIP
MAX200CWP	0°C to +70°C	20 Wide SO
MAX200EPP	-40°C to +85°C	20 Plastic DIP
MAX200EWP	-40°C to +85°C	20 Wide SO
MAX201 CPD	0°C to +70°C	14 Plastic DIP
MAX201CWE	0°C to +70°C	16 Wide SO
MAX201C/D	0°C to +70°C	Dice*
MAX201EPD	-40°C to +85°C	14 Plastic DIP
MAX201EWE	-40°C to +85°C	16 Wide SO
MAX202 CPE	0°C to +70°C	16 Plastic DIP
MAX202CSE	0°C to +70°C	16 Narrow SO
MAX202CWE	0°C to +70°C	16 Wide SO
MAX202C/D	0°C to +70°C	Dice*
MAX202EPE	-40°C to +85°C	16 Plastic DIP
MAX202ESE	-40°C to +85°C	16 Narrow SO
MAX202EWE	-40°C to +85°C	16 Wide SO
MAX203 CPP	0°C to +70°C	20 Plastic DIP
MAX203CWP	0°C to +70°C	20 Wide SO
MAX203EPP	-40°C to +85°C	20 Plastic DIP
MAX203EWP	-40°C to +85°C	20 Wide SO
MAX204 CPE	0°C to +70°C	16 Plastic DIP
MAX204CWE	0°C to +70°C	16 Wide SO
MAX204C/D	0°C to +70°C	Dice*
MAX204EPE	-40°C to +85°C	16 Plastic DIP
MAX204EWE	-40°C to +85°C	16 Wide SO
MAX205 CPG	0°C to +70°C	24 Wide Plastic DIP
MAX205EPG	-40°C to +85°C	24 Wide Plastic DIP
MAX206 CNG	0°C to +70°C	24 Narrow Plastic DIP
MAX206CWG	0°C to +70°C	24 Wide SO
MAX206CAG	0°C to +70°C	24 SSOP
MAX206ENG	-40°C to +85°C	24 Narrow Plastic DIP

PART	TEMP RANGE	PIN-PACKAGE
MAX206EWG	-40°C to +85°C	24 Wide SO
MAX206EAG	-40°C to +85°C	24 SSOP
MAX207 CNG	0°C to +70°C	24 Narrow Plastic DIP
MAX207CWG	0°C to +70°C	24 Wide SO
MAX207CAG	0°C to +70°C	24 SSOP
MAX207ENG	-40°C to +85°C	24 Narrow Plastic DIP
MAX207EWG	-40°C to +85°C	24 Wide SO
MAX207EAG	-40°C to +85°C	24 SSOP
MAX208 CNG	0°C to +70°C	24 Narrow Plastic DIP
MAX208CWG	0°C to +70°C	24 Wide SO
MAX208CAG	0°C to +70°C	24 SSOP
MAX208C/D	0°C to +70°C	Dice*
MAX208ENG	-40°C to +85°C	24 Narrow Plastic DIP
MAX208EWG	-40°C to +85°C	24 Wide SO
MAX208EAG	-40°C to +85°C	24 SSOP
MAX209 CNG	0°C to +70°C	24 Narrow Plastic DIP
MAX209CWG	0°C to +70°C	24 Wide SO
MAX209C/D	0°C to +70°C	Dice*
MAX209ENG	-40°C to +85°C	24 Narrow Plastic DIP
MAX209EWG	-40°C to +85°C	24 Wide SO
MAX211 CWI	0°C to +70°C	28 Wide SO
MAX211CAI	0°C to +70°C	28 SSOP
MAX211C/D	0°C to +70°C	Dice*
MAX211EWI	-40°C to +85°C	28 Wide SO
MAX211EAI	-40°C to +85°C	28 SSOP
MAX213 CWI	0°C to +70°C	28 Wide SO
MAX213CAI	0°C to +70°C	28 SSOP
MAX213C/D	0°C to +70°C	Dice*
MAX213EWI	-40°C to +85°C	28 Wide SO
MAX213EAI	-40°C to +85°C	28 SSOP

*Contact factory for dice specifications.

Selector Guide (continued)

PART	POWER-SUPPLY VOLTAGE (V)	NUMBER OF RS-232 DRIVERS	NUMBER OF RS-232 RECEIVERS	NUMBER OF RECEIVERS ACTIVE IN SHUTDOWN	NUMBER OF EXTERNAL CAPACITORS (0.1µF)	LOW-POWER SHUTDOWN/TTL THREE-STATE
MAX204	+5	4	0	0	4	No/No
MAX205	+5	5	5	0	None	Yes/Yes
MAX206	+5	4	3	0	4	Yes/Yes
MAX207	+5	5	3	0	4	No/No
MAX208	+5	4	4	0	4	No/No
MAX209	+5 and +9.0 to +13.2	3	5	0	2	No/Yes
MAX211	+5	4	5	0	4	Yes/Yes
MAX213	+5	4	5	2	4	Yes/Yes

Package Information

For the latest package outline information and land patterns (footprints), go to www.maximintegrated.com/packages. Note that a “+”, “#”, or “-” in the package code indicates RoHS status only. Package drawings may show a different suffix character, but the drawing pertains to the package regardless of RoHS status.

PACKAGE TYPE	PACKAGE CODE	DOCUMENT NO.
14 CDIP	J14-3	21-0045
16 CDIP	J16-3	21-0045
20 CDIP	J20-2	21-0045
24 CDIP	R24-4	21-0045
14 PDIP	P14-3	21-0043
16 PDIP	P16-1	21-0043
20 PDIP	P20-3	21-0043
24 PDIP	N24-2	21-0043
24 PDIP	N24-3	21-0043
24 PDIP	P24-1	21-0044
24 PDIP	P24M-1	21-0044
16 SO	S16-3	21-0041
16 SO	W16-3	21-0042
16 SO	W16-1	21-0042
20 SO	W20M-1	21-0042
20 SO	W20-3	21-0042
24 SO	W24-2	21-0042
28 SO	W28-1	21-0042
28 SO	W28-2	21-0042
24 SSOP	A24-3	21-0056
24 SSOP	A24-2	21-0056
28 SSOP	A28-1	21-0056
16 TSSOP	U16-1	21-0066

Revision History



REVISION NUMBER	REVISION DATE	DESCRIPTION	PAGES CHANGED
6	10/03	Changed the Features section and section information to the <i>Next-Generation Device Features</i> section.	1
7	12/05	Added Note 1 to the <i>Absolute Maximum Ratings</i> section.	2
8	1/15	Updated page 1 content	1

For pricing, delivery, and ordering information, please contact Maxim Direct at 1-888-629-4642, or visit Maxim Integrated's website at www.maximintegrated.com.

Maxim Integrated cannot assume responsibility for use of any circuitry other than circuitry entirely embodied in a Maxim Integrated product. No circuit patent licenses are implied. Maxim Integrated reserves the right to change the circuitry and specifications without notice at any time. The parametric values (min and max limits) shown in the Electrical Characteristics table are guaranteed. Other parametric values quoted in this data sheet are provided for guidance.

Looking for pricing, stock, or lifecycle information?

Click below to explore more details on WIN SOURCE:

-  View [MAX208CAG+](#) on WIN SOURCE
-  [Maxim Integrated](#) Information

Optimize Your Supply Chain with WIN SOURCE Solutions

-  Global Sourcing Solution
-  Obsolete Management
-  Cost Control Management
-  Shortage Management
-  Alternative Solution
-  Excess Inventory Management