



**THE DATASHEET OF
MAX16029TG+T**



Dual-/Triple-/Quad-Voltage, Capacitor-Adjustable, Sequencing/Supervisory Circuits

General Description

The MAX16025–MAX16030 are dual/triple-/quad-voltage monitors and sequencers that are offered in a small TQFN package. These devices offer enormous design flexibility as they allow fixed and adjustable thresholds to be selected through logic inputs and provide sequence timing through small external capacitors. These versatile devices are ideal for use in a wide variety of multivoltage applications.

As the voltage at each monitored input exceeds its respective threshold, its corresponding output goes high after a propagation delay or a capacitor-set time delay. When a voltage falls below its threshold, its respective output goes low after a propagation delay. Each detector circuit also includes its own enable input, allowing the power-good outputs to be shut off independently. The independent output for each detector is available with push-pull or open-drain configuration with the open-drain version capable of supporting voltages up to 28V, thereby allowing them to interface to shutdown and enable inputs of various DC-DC regulators. Each detector can operate independently as four separate supervisory circuits or can be daisy-chained to provide controlled power-supply sequencing.

The MAX16025–MAX16030 also include a reset function that deasserts only after all of the independently monitored voltages exceed their threshold. The reset timeout is internally fixed or can be adjusted externally. These devices are offered in a 4mm x 4mm TQFN package and are fully specified from -40°C to +125°C.

Applications

Multivoltage Systems
DC-DC Supplies
Servers/Workstations
Storage Systems
Networking/Telecommunication Equipment

Selector Guide

| PART | MONITORED VOLTAGES | INDEPENDENT OUTPUTS | RESET OUTPUT |
|----------|--------------------|---------------------|--------------|
| MAX16025 | 2 | 2 (Open-drain) | Open-drain |
| MAX16026 | 2 | 2 (Push-pull) | Push-pull |
| MAX16027 | 3 | 3 (Open-drain) | Open-drain |
| MAX16028 | 3 | 3 (Push-pull) | Push-pull |
| MAX16029 | 4 | 4 (Open-drain) | Open-drain |
| MAX16030 | 4 | 4 (Push-pull) | Push-pull |

Features

- ◆ 2.2V to 28V Operating Voltage Range
- ◆ Fixed Thresholds for 3.3V, 2.5V, 1.8V, 1.5V, and 1.2V Systems
- ◆ 1.5% Accurate Adjustable Threshold Monitors Voltages Down to 0.5V
- ◆ 2.7% Accurate Fixed Thresholds Over Temperature
- ◆ Fixed (140ms min)/Capacitor-Adjustable Delay Timing
- ◆ Independent Open-Drain/Push-Pull Outputs
- ◆ Enable Inputs for Each Monitored Voltage
- ◆ 9 Logic-Selectable Threshold Options
- ◆ Manual Reset and Tolerance Select (5%/10%) Inputs
- ◆ Small, 4mm x 4mm TQFN Package
- ◆ Fully Specified from -40°C to +125°C

Ordering Information

| PART* | TEMP RANGE | PIN-PACKAGE | PKG CODE |
|-------------|-----------------|-------------|----------|
| MAX16025TE+ | -40°C to +125°C | 16 TQFN | T1644-4 |
| MAX16026TE+ | -40°C to +125°C | 16 TQFN | T1644-4 |
| MAX16027TP+ | -40°C to +125°C | 20 TQFN | T2044-3 |
| MAX16028TP+ | -40°C to +125°C | 20 TQFN | T2044-3 |
| MAX16029TG+ | -40°C to +125°C | 24 TQFN | T2444-4 |
| MAX16030TG+ | -40°C to +125°C | 24 TQFN | T2444-4 |

+ Denotes lead-free package.

*For tape and reel, add a "T" after the "+." All tape and reel orders are available in 2.5k increments.

Pin Configurations

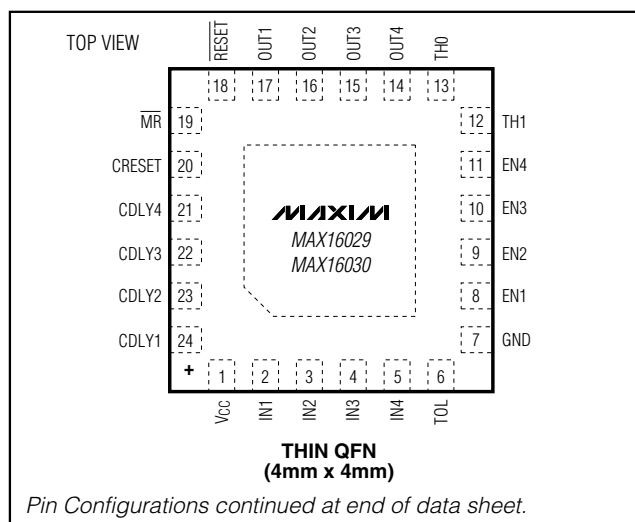

Dual-/Triple-/Quad-Voltage, Capacitor-Adjustable, Sequencing/Supervisory Circuits

ABSOLUTE MAXIMUM RATINGS

(All voltages referenced to GND.)

| | | | |
|-----------------------------|-----------------------------------|---|-----------------------------------|
| V _{CC} | -0.3V to +30V | CRESET | -0.3V to (V _{CC} + 0.3V) |
| EN1-EN4 | -0.3V to (V _{CC} + 0.3V) | Input/Output Current (all pins)..... | ±20mA |
| OUT1-OUT4 (push-pull)..... | -0.3V to (V _{CC} + 0.3V) | Continuous Power Dissipation (T _A = +70°C) | |
| OUT1-OUT4 (open-drain)..... | -0.3V to +30V | 16-Pin TQFN (derate 25mW/°C above +70°C) | 2000mW |
| RESET (push-pull)..... | -0.3V to (V _{CC} + 0.3V) | 20-Pin TQFN (derate 25.6mW/°C above +70°C) | 2051mW |
| RESET (open-drain)..... | -0.3V to 30V | 24-Pin TQFN (derate 27.8mW/°C above +70°C) | 2222mW |
| IN1-IN4..... | -0.3V to (V _{CC} + 0.3V) | Operating Temperature Range | -40°C to +125°C |
| MR, TOL, TH1, TH0 | -0.3V to (V _{CC} + 0.3V) | Storage Temperature Range | -65°C to +150°C |
| CDLY1-CDLY4..... | -0.3V to +6V | Junction Temperature | +150°C |
| | | Lead Temperature (soldering, 10s)..... | +300°C |

Stresses beyond those listed under "Absolute Maximum Ratings" may cause permanent damage to the device. These are stress ratings only, and functional operation of the device at these or any other conditions beyond those indicated in the operational sections of the specifications is not implied. Exposure to absolute maximum rating conditions for extended periods may affect device reliability.

ELECTRICAL CHARACTERISTICS

(V_{CC} = 2.2V to 28V, T_A = -40°C to +125°C, unless otherwise specified. Typical values are at V_{CC} = 3.3V and T_A = +25°C.) (Note 1)

| PARAMETER | SYMBOL | CONDITIONS | MIN | TYP | MAX | UNITS |
|--|----------------------|---|------------------------|-------|-------|-------|
| SUPPLY | | | | | | |
| Operating Voltage Range | V _{CC} | (Note 2) | 2.2 | | 28.0 | V |
| Undervoltage Lockout | UVLO | (Note 2) | 1.8 | 1.9 | 2.0 | V |
| Undervoltage-Lockout Hysteresis | UVLO _{HYST} | V _{CC} falling | | 50 | | mV |
| V _{CC} Supply Current | I _{CC} | All OUT _n and RESET at logic-high (IN _n current excluded) | V _{CC} = 3.3V | 40 | 75 | μA |
| | | | V _{CC} = 12V | 47 | 75 | |
| | | | V _{CC} = 28V | 52 | 80 | |
| INPUTS (IN_n) | | | | | | |
| IN _n Thresholds (IN _n Falling) | V _{TH} | 3.3V threshold, TOL = GND | 2.970 | 3.052 | 3.135 | V |
| | | 3.3V threshold, TOL = V _{CC} | 2.805 | 2.888 | 2.970 | |
| | | 2.5V threshold, TOL = GND | 2.250 | 2.313 | 2.375 | |
| | | 2.5V threshold, TOL = V _{CC} | 2.125 | 2.187 | 2.250 | |
| | | 1.8V threshold, TOL = GND | 1.620 | 1.665 | 1.710 | |
| | | 1.8V threshold, TOL = V _{CC} | 1.530 | 1.575 | 1.620 | |
| | | 1.5V threshold, TOL = GND | 1.350 | 1.387 | 1.425 | |
| | | 1.5V threshold, TOL = V _{CC} | 1.275 | 1.312 | 1.350 | |
| | | 1.2V threshold, TOL = GND | 1.080 | 1.110 | 1.140 | |
| | | 1.2V threshold, TOL = V _{CC} | 1.020 | 1.050 | 1.080 | |
| Adjustable Threshold (IN _n Falling) | V _{TH} | TOL = GND | 0.492 | 0.5 | 0.508 | V |
| | | TOL = V _{CC} | 0.463 | 0.472 | 0.481 | |
| IN _n Hysteresis (IN _n Rising) | V _{HYST} | | | 0.5 | | % |
| IN _n Input Resistance | | Fixed threshold | 500 | 918 | | kΩ |
| IN _n Input Current | I _L | Adjustable threshold only (V _{IN_n} = 1V) | -100 | | +100 | nA |

Dual-/Triple-/Quad-Voltage, Capacitor-Adjustable, Sequencing/Supervisory Circuits

MAX16025-MAX16030

ELECTRICAL CHARACTERISTICS (continued)

($V_{CC} = 2.2V$ to $28V$, $T_A = -40^{\circ}C$ to $+125^{\circ}C$, unless otherwise specified. Typical values are at $V_{CC} = 3.3V$ and $T_A = +25^{\circ}C$.) (Note 1)

| PARAMETER | SYMBOL | CONDITIONS | MIN | TYP | MAX | UNITS |
|---|-----------------|---|---------------------|-------|-------|---------|
| CRESET AND CDLY_ | | | | | | |
| CRESET Threshold | $V_{TH-RESET}$ | CRESET rising, $V_{CC} = 3.3V$ | 0.465 | 0.5 | 0.535 | V |
| CRESET Charge Current | $I_{CH-RESET}$ | $V_{CC} = 3.3V$ | 380 | 500 | 620 | nA |
| CDLY_ Threshold | $V_{TH-CDLY}$ | CDLY_ rising, $V_{CC} = 3.3V$ | 0.95 | 1 | 1.05 | V |
| CDLY_ Charge Current | $I_{CH-CDLY}$ | $V_{CC} = 3.3V$ | 200 | 250 | 300 | nA |
| DIGITAL LOGIC INPUTS ($EN_$, \overline{MR}, TOL, TH1, TH0) | | | | | | |
| Input Low Voltage | V_{IL} | | | | 0.4 | V |
| Input High Voltage | V_{IH} | | 1.4 | | | V |
| TH1, TH0 Logic-Input Floating | | | | 0.6 | | V |
| TOL, TH1, TH0 Logic-Input Current | | $V_{TOL}, V_{TH1}, V_{TH0} = GND$ or V_{CC} | -1 | | +1 | μA |
| $EN_$ Input Leakage Current | | $V_{EN_} = V_{CC}$ or GND | -100 | | +100 | nA |
| \overline{MR} Internal Pullup Current | | $V_{CC} = 3.3V$ | 250 | 535 | 820 | nA |
| OUTPUTS ($OUT_$, \overline{RESET}) | | | | | | |
| Output Low Voltage (Open-Drain or Push-Pull) | V_{OL} | $V_{CC} \geq 1.2V, I_{SINK} = 90\mu A$ | | | 0.3 | V |
| | | $V_{CC} \geq 2.25V, I_{SINK} = 0.5mA$ | | | 0.3 | |
| | | $V_{CC} \geq 4.5V, I_{SINK} = 1mA$ | | | 0.35 | |
| Output High Voltage (Push-Pull) | V_{OH} | $V_{CC} \geq 3V, I_{SOURCE} = 500\mu A$ | $0.8 \times V_{CC}$ | | | V |
| | | $V_{CC} \geq 4.5V, I_{SOURCE} = 800\mu A$ | $0.8 \times V_{CC}$ | | | |
| Output Leakage Current (Open-Drain) | I_{LKG} | Output not asserted low, $V_{OUT} = 28V$ | | | 1 | μA |
| Reset Timeout Period | t_{RP} | CRESET = V_{CC} , $V_{CC} = 3.3V$ | 140 | 190 | 260 | ms |
| | | CRESET open | | 0.030 | | |
| TIMING | | | | | | |
| $IN_$ to $OUT_$ Propagation Delay | t_{DELAY+} | $IN_$ rising, CDLY_ open | | 35 | | μs |
| | t_{DELAY-} | $IN_$ falling, CDLY_ open | | 20 | | |
| $IN_$ to \overline{RESET} Propagation Delay | $t_{RST-DELAY}$ | $IN_$ falling | | 35 | | μs |
| \overline{MR} Minimum Input Pulse Width | | (Note 3) | 2 | | | μs |
| $EN_$ or \overline{MR} Glitch Rejection | | | | 280 | | ns |
| $EN_$ to $OUT_$ Delay | t_{OFF} | From device enabled to device disabled | | 3 | | μs |
| | t_{ON} | From device disabled to device enabled (CDLY_ open) | | 30 | | |
| \overline{MR} to \overline{RESET} Delay | | \overline{MR} falling | | 3 | | μs |

Note 1: Devices are production tested at $T_A = +25^{\circ}C$. Limits over temperature are guaranteed by design.

Note 2: Operating below the UVLO causes all outputs to go low. The outputs are guaranteed to be in the correct state for V_{CC} down to 1.2V.

Note 3: In order to guarantee an assertion, the minimum input pulse width must be greater than $2\mu s$.

Dual-/Triple-/Quad-Voltage, Capacitor-Adjustable, Sequencing/Supervisory Circuits

Typical Operating Characteristics

($V_{CC} = 3.3V$, $T_A = +25^\circ C$, unless otherwise noted.)

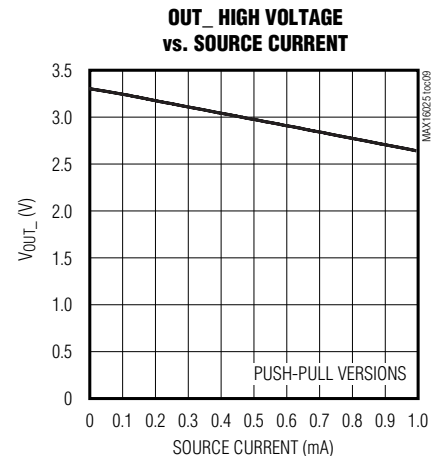
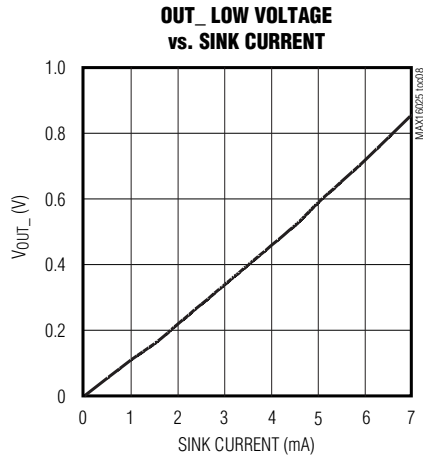
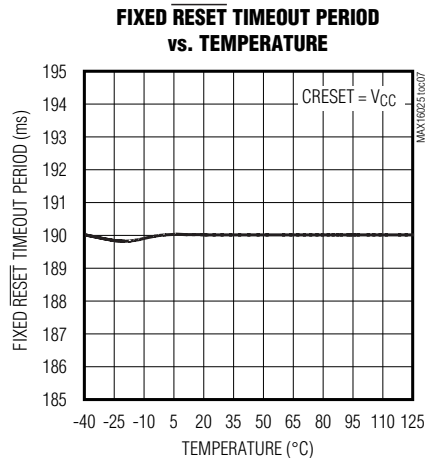
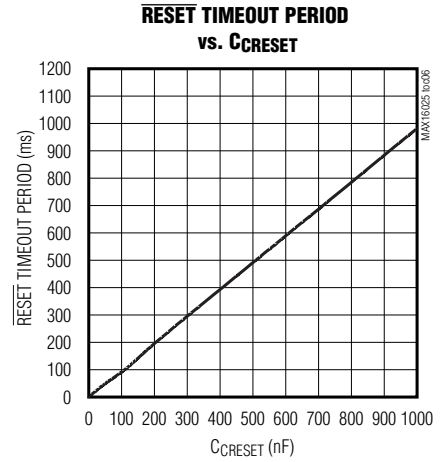
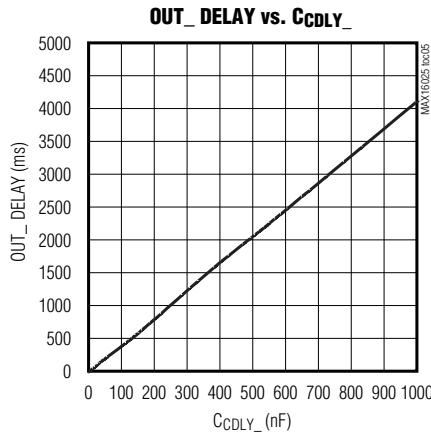
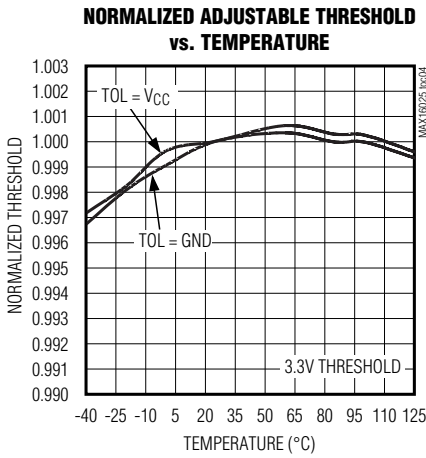
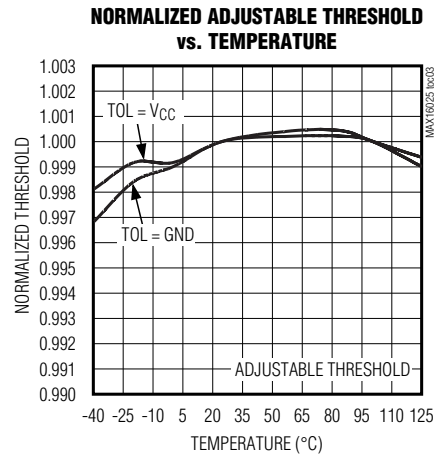
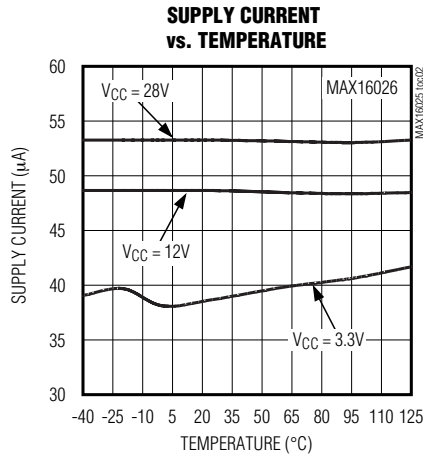
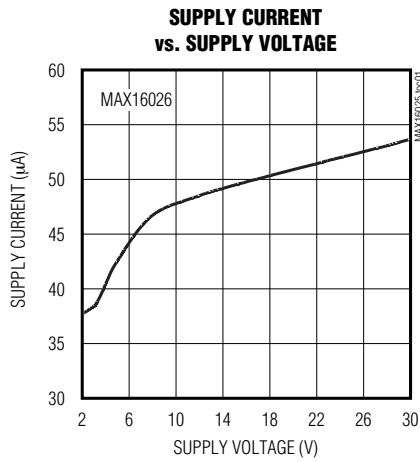

Dual-/Triple-/Quad-Voltage, Capacitor-Adjustable, Sequencing/Supervisory Circuits

Typical Operating Characteristics (continued)

($V_{CC} = 3.3V$, $T_A = +25^\circ C$, unless otherwise noted.)

MAX16025-MAX16030

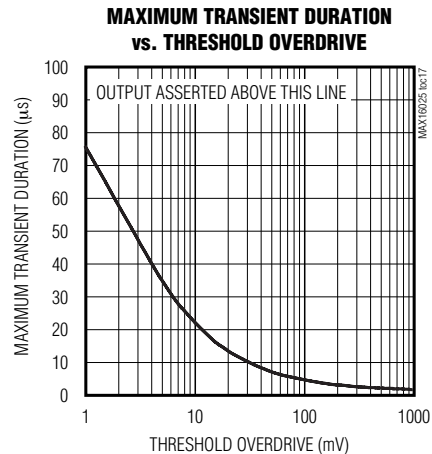
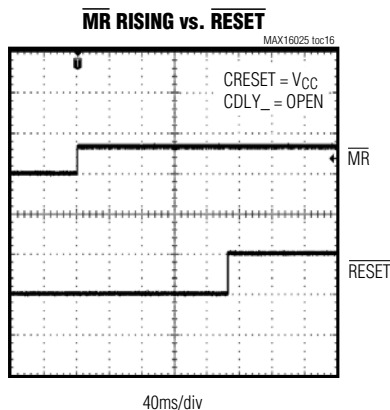
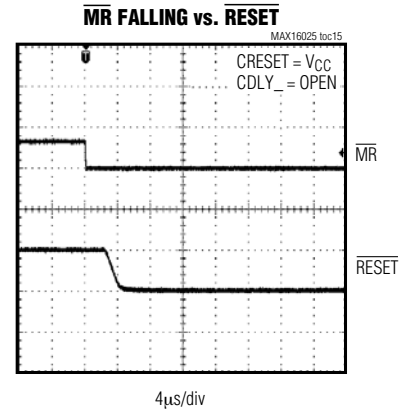
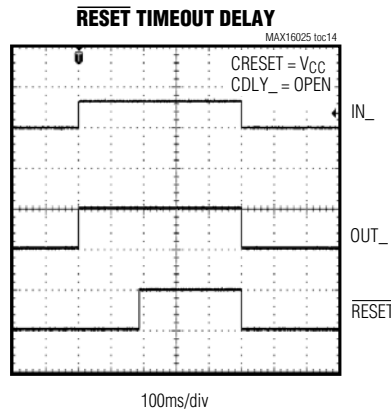
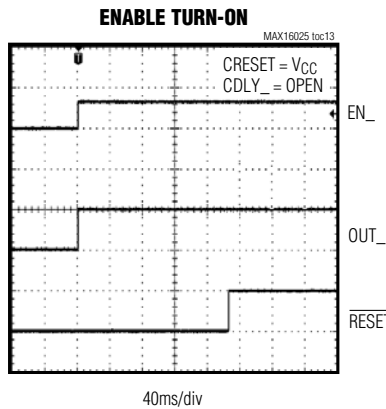
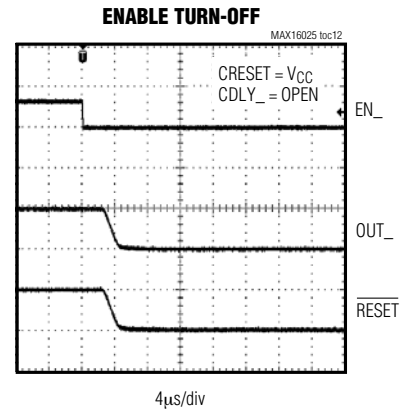
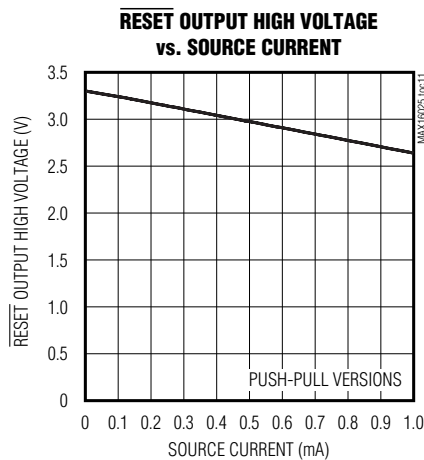
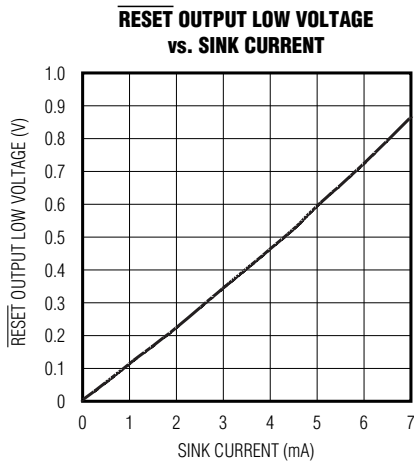

Dual-/Triple-/Quad-Voltage, Capacitor-Adjustable, Sequencing/Supervisory Circuits

Pin Description

| PIN | | | NAME | FUNCTION |
|-----------------------|-----------------------|-----------------------|-----------------|---|
| MAX16025/ MAX16026 | MAX16027/ MAX16028 | MAX16029/ MAX16030 | | |
| 1 | 1 | 1 | V _{CC} | Supply Voltage Input. Connect a 2.2V to 28V supply voltage to power the device. All outputs are low when V _{CC} is below the UVLO. For noisy systems, bypass V _{CC} to GND with a 0.1μF capacitor. |
| 2 | 2 | 2 | IN1 | Monitored Input 1. When the voltage at IN1 exceeds its threshold, OUT1 goes high after the capacitor-adjustable delay period. When the voltage at IN1 falls below its threshold, OUT1 goes low after a propagation delay. |
| 3 | 3 | 3 | IN2 | Monitored Input 2. When the voltage at IN2 exceeds its threshold, OUT2 goes high after the capacitor-adjustable delay period. When the voltage at IN2 falls below its threshold, OUT2 goes low after a propagation delay. |
| — | 4 | 4 | IN3 | Monitored Input 3. When the voltage at IN3 exceeds its threshold, OUT3 goes high after the capacitor-adjustable delay period. When the voltage at IN3 falls below its threshold, OUT3 goes low after a propagation delay. |
| — | — | 5 | IN4 | Monitored Input 4. When the voltage at IN4 exceeds its threshold, OUT4 goes high after the capacitor-adjustable delay period. When the voltage at IN4 falls below its threshold, OUT4 goes low after a propagation delay. |
| 4 | 5 | 6 | TOL | Threshold Tolerance Input. Connect TOL to GND to select thresholds 5% below nominal. Connect TOL to V _{CC} to select thresholds 10% below nominal. |
| 5 | 6 | 7 | GND | Ground |
| 6 | 7 | 8 | EN1 | Active-High Logic-Enable Input 1. Driving EN1 low causes OUT1 to go low regardless of the input voltage. Drive EN1 high to enable the monitoring comparator. |
| 7 | 8 | 9 | EN2 | Active-High Logic-Enable Input 2. Driving EN2 low causes OUT2 to go low regardless of the input voltage. Drive EN2 high to enable the monitoring comparator. |
| — | 9 | 10 | EN3 | Active-High Logic-Enable Input 3. Driving EN3 low causes OUT3 to go low regardless of the input voltage. Drive EN3 high to enable the monitoring comparator. |
| — | — | 11 | EN4 | Active-High Logic-Enable Input 4. Driving EN4 low causes OUT4 to go low regardless of the input voltage. Drive EN4 high to enable the monitoring comparator. |
| 8 | 10 | 12 | TH1 | Threshold Select Input 1. Connect TH1 to V _{CC} or GND, or leave it open to select the input-voltage threshold option in conjunction with TH0 (see Table 2). |
| 9 | 11 | 13 | TH0 | Threshold Select Input 0. Connect TH0 to V _{CC} or GND, or leave it open to select the input-voltage threshold option in conjunction with TH1 (see Table 2). |
| — | — | 14 | OUT4 | Output 4. When the voltage at IN4 is below its threshold or EN4 goes low, OUT4 goes low. |
| — | 12 | 15 | OUT3 | Output 3. When the voltage at IN3 is below its threshold or EN3 goes low, OUT3 goes low. |
| 10 | 13 | 16 | OUT2 | Output 2. When the voltage at IN2 is below its threshold or EN2 goes low, OUT2 goes low. |

Dual-/Triple-/Quad-Voltage, Capacitor-Adjustable, Sequencing/Supervisory Circuits

Pin Description (continued)

MAX16025-MAX16030

| PIN | | | NAME | FUNCTION |
|-----------------------|-----------------------|-----------------------|---------------------------|---|
| MAX16025/ MAX16026 | MAX16027/ MAX16028 | MAX16029/ MAX16030 | | |
| 11 | 14 | 17 | OUT1 | Output 1. When the voltage at IN1 is below its threshold or EN1 goes low, OUT1 goes low. |
| 12 | 15 | 18 | $\overline{\text{RESET}}$ | Active-Low Reset Output. $\overline{\text{RESET}}$ asserts low when any of the monitored voltages (IN _n) falls below its respective threshold, any EN _n goes low, or $\overline{\text{MR}}$ is asserted. $\overline{\text{RESET}}$ remains asserted for the reset timeout period after all of the monitored voltages exceed their respective threshold, all EN _n are high, all OUT _n are high, and $\overline{\text{MR}}$ is deasserted. |
| 13 | 16 | 19 | $\overline{\text{MR}}$ | Active-Low Manual Reset Input. Pull $\overline{\text{MR}}$ low to assert $\overline{\text{RESET}}$ low. $\overline{\text{RESET}}$ remains low for the reset timeout period after $\overline{\text{MR}}$ is deasserted (as long as all OUT _n are high). |
| 14 | 17 | 20 | CRESET | Capacitor-Adjustable Reset Delay Input. Connect an external capacitor from CRESET to GND to set the reset timeout period or connect to V _{CC} for the default 140ms minimum reset timeout period. Leave CRESET open for internal propagation delay. |
| — | — | 21 | CDLY4 | Capacitor-Adjustable Delay Input 4. Connect an external capacitor from CDLY4 to GND to set the IN4 to OUT4 (and EN4 to OUT4) delay period. Leave CDLY4 open for internal propagation delay. |
| — | 18 | 22 | CDLY3 | Capacitor-Adjustable Delay Input 3. Connect an external capacitor from CDLY3 to GND to set the IN3 to OUT3 (and EN3 to OUT3) delay period. Leave CDLY3 open for internal propagation delay. |
| 15 | 19 | 23 | CDLY2 | Capacitor-Adjustable Delay Input 2. Connect an external capacitor from CDLY2 to GND to set the IN2 to OUT2 (and EN2 to OUT2) delay period. Leave CDLY2 open for internal propagation delay. |
| 16 | 20 | 24 | CDLY1 | Capacitor-Adjustable Delay Input 1. Connect an external capacitor from CDLY1 to GND to set the IN1 to OUT1 (and EN1 to OUT1) delay period. Leave CDLY1 open for internal propagation delay. |
| — | — | — | EP | Exposed Pad. EP is internally connected to GND. Connect EP to the ground plane. |

Table 1. Output State*

| EN _n | IN _n | OUT _n |
|-----------------|---|---|
| Low | V _{IN_n} < V _{TH} | Low |
| High | V _{IN_n} < V _{TH} | Low |
| Low | V _{IN_n} > V _{TH} | Low |
| High | V _{IN_n} > V _{TH} | OUT _n = high (MAX16026/MAX16028/ MAX16030) |
| | | OUT _n = high impedance (MAX16025/MAX16027/ MAX16029) |

*When V_{CC} falls below the UVLO, all outputs go low regardless of the state of EN_n and V_{IN_n}. The outputs are guaranteed to be in the correct state for V_{CC} down to 1.2V.

Table 2. Input-Voltage Threshold Selector

| TH1/TH0 LOGIC | IN1 (ALL VERSIONS) (V) | IN2 (ALL VERSIONS) (V) | IN3 (MAX16027/MAX16028) (V) | IN4 (MAX16029/MAX16030) (V) |
|---------------|------------------------|------------------------|-----------------------------|-----------------------------|
| Low/Low | 3.3 | 2.5 | 1.8 | 1.5 |
| Low/High | 3.3 | 1.8 | Adj | Adj |
| Low/Open | 3.3 | 1.5 | Adj | Adj |
| High/Low | 3.3 | 1.2 | 1.8 | 2.5 |
| High/High | 2.5 | 1.8 | Adj | Adj |
| High/Open | 3.3 | Adj | 2.5 | Adj |
| Open/Low | 3.3 | Adj | Adj | Adj |
| Open/High | 2.5 | Adj | Adj | Adj |
| Open/Open | Adj | Adj | Adj | Adj |

Dual-/Triple-/Quad-Voltage, Capacitor-Adjustable, Sequencing/Supervisory Circuits

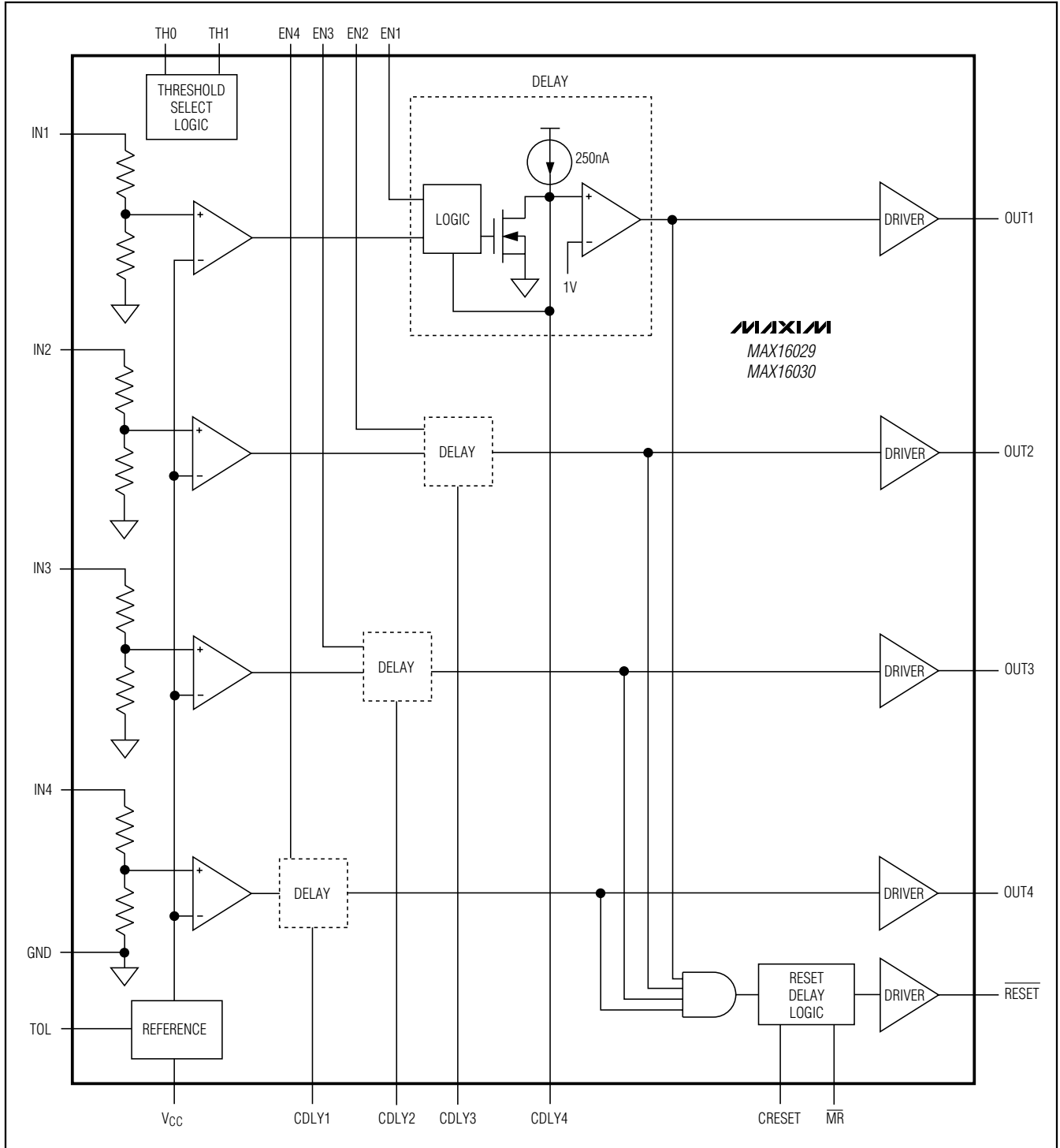

Figure 1. MAX16029/MAX16030 Simplified Functional Diagram

Dual-/Triple-/Quad-Voltage, Capacitor-Adjustable, Sequencing/Supervisory Circuits

MAX16025-MAX16030

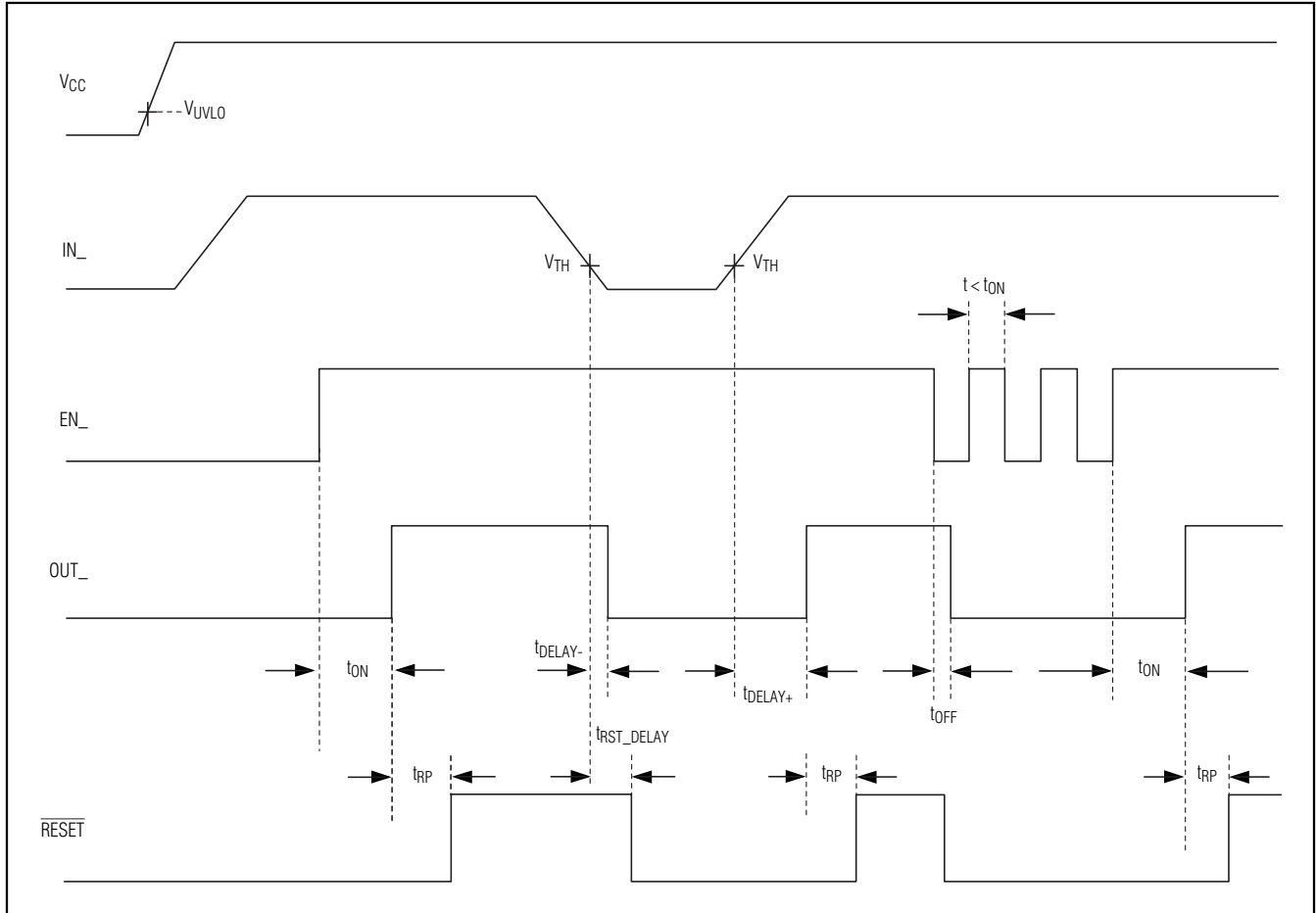

Figure 2. Timing Diagram (CDLY_Open)

Detailed Description

The MAX16025-MAX16030 are low-voltage, accurate, dual/triple-/quad-voltage microprocessor (μ P) supervisors in a small TQFN package. These devices provide supervisory and sequencing functions for complex multivoltage systems. The MAX16025/MAX16026 monitor two voltages, the MAX16027/MAX16028 monitor three voltages, and the MAX16029/MAX16030 monitor four voltages.

The MAX16025-MAX16030 offer independent outputs and enable functions for each monitored voltage. This configuration allows the device to operate as four separate supervisory circuits or be daisy-chained together to allow controlled sequencing of power supplies during

power-up initialization. When all of the monitored voltages exceed their respective thresholds, an independent reset output deasserts to allow the system processor to operate.

These devices offer enormous flexibility as there are nine threshold options that are selected through two threshold-select logic inputs. Each monitor circuit also offers an independent enable input to allow both digital and analog control of each monitor output. A tolerance select input allows these devices to be used in systems requiring 5% or 10% power-supply tolerances. In addition, the time delays and reset timeout can be adjusted using small capacitors. There is also a fixed 140ms minimum reset timeout feature.

Dual-/Triple-/Quad-Voltage, Capacitor-Adjustable, Sequencing/Supervisory Circuits

Applications Information

Tolerance

The MAX16025-MAX16030 feature a pin-selectable threshold tolerance. Connect TOL to GND to select the thresholds 5% below the nominal value. Connect TOL to V_{CC} to select the threshold tolerance 10% below the nominal voltage. Do not leave TOL unconnected.

Adjustable Input

These devices offer several monitoring options with both fixed and/or adjustable reset thresholds (see Table 2). For the adjustable threshold inputs, the threshold voltage (V_{TH}) at each adjustable IN₋ input is typically 0.5V (TOL = GND) or 0.472V (TOL = V_{CC}). To monitor a voltage V_{INTH}, connect a resistive divider network to the circuit as shown in Figure 3 and use the following equation to calculate the threshold voltage:

$$V_{INTH} = V_{TH} \times \left(1 + \frac{R1}{R2}\right)$$

Choosing the proper external resistors is a balance between accuracy and power use. The input to the voltage monitor is a high-impedance input with a small 100nA leakage current. This leakage current contributes to the overall error of the threshold voltage where the output is asserted. This induced error is proportional to the value of the resistors used to set the threshold. With lower value resistors, this error is reduced, but the amount of power consumed in the resistors increases.

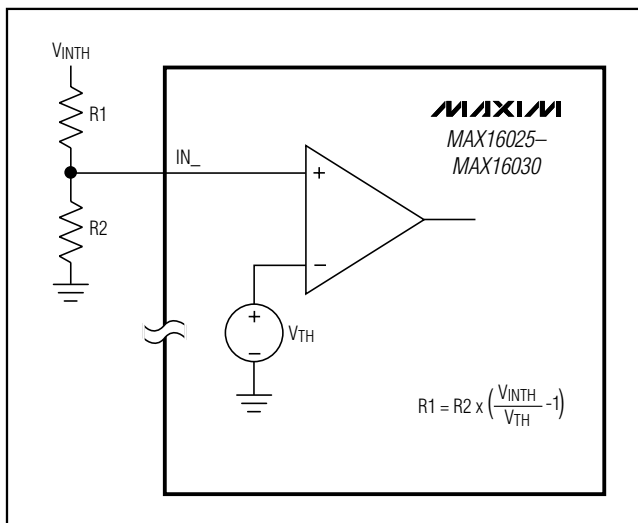

Figure 3. Setting the Adjustable Input

The following equation is provided to help estimate the value of the resistors based on the amount of acceptable error:

$$R1 = \frac{e_A \times V_{INTH}}{I_L}$$

where e_A is the fraction of the maximum acceptable absolute resistive divider error attributable to the input leakage current (use 0.01 for $\pm 1\%$), V_{INTH} is the voltage at which the output (OUT₋) should assert, and I_L is the worst-case IN₋ leakage current (see the *Electrical Characteristics*). Calculate R2 as follows:

$$R2 = \frac{V_{TH} \times R1}{V_{INTH} - V_{TH}}$$

Unused Inputs

Connect any unused IN₋ and EN₋ inputs to V_{CC}.

OUT₋ Output

An OUT₋ goes low when its respective IN₋ input voltage drops below its specified threshold or when its EN₋ goes low (see Table 1). OUT₋ goes high when EN₋ is high and V_{IN₋} is above its threshold after a time delay. The MAX16025/MAX16027/MAX16029 feature open-drain, outputs while the MAX16026/MAX16028/MAX16030 have push-pull outputs. Open-drain outputs require an external pullup resistor to any voltage from 0 to 28V.

RESET Output

$\overline{\text{RESET}}$ asserts low when any of the monitored voltages (IN₋) falls below its respective threshold, any EN₋ goes low, or $\overline{\text{MR}}$ is asserted. $\overline{\text{RESET}}$ remains asserted for the reset timeout period after all of the monitored voltages exceed their respective threshold, all EN₋ are high, all OUT₋ are high, and $\overline{\text{MR}}$ is deasserted. The MAX16025/MAX16027/MAX16029 have an open-drain, active-low reset output, while the MAX16026/MAX16028/MAX16030 have a push-pull, active-low reset output. Open-drain $\overline{\text{RESET}}$ requires an external pullup resistor to any voltage from 0 to 28V.

Adjustable Reset Timeout Period (CRESET)

All of these parts offer an internally fixed reset timeout (140ms min) by connecting CRESET to V_{CC}. The reset timeout can also be adjusted by connecting a capacitor from CRESET to GND. When the voltage at CRESET reaches 0.5V, $\overline{\text{RESET}}$ goes high. When $\overline{\text{RESET}}$ goes high, CRESET is immediately held low.

Dual-/Triple-/Quad-Voltage, Capacitor-Adjustable, Sequencing/Supervisory Circuits

Calculate the reset timeout period as follows:

$$t_{RP} = \frac{V_{TH-RESET}}{I_{CH-RESET}} \times C_{CRESET} + 35 \times 10^{-6}$$

where $V_{TH-RESET}$ is 0.5V, $I_{CH-RESET}$ is 0.5 μ A, t_{RP} is in seconds, and C_{CRESET} is in Farads. To ensure timing accuracy and proper operation, minimize leakage at C_{CRESET} .

Adjustable Delay (CDLY_)

When V_{IN} rises above V_{TH} with EN_+ high, the internal 250nA current source begins charging an external capacitor connected from $CDLY_+$ to GND. When the voltage at $CDLY_+$ reaches 1V, OUT_+ goes high. When OUT_+ goes high, $CDLY_+$ is immediately held low. Adjust the delay (t_{DELAY}) from when V_{IN} rises above V_{TH} (with EN_+ high) to OUT_+ going high according to the equation:

$$t_{DELAY} = \frac{V_{TH-CDLY}}{I_{CH-CDLY}} \times C_{CDLY} + 35 \times 10^{-6}$$

where $V_{TH-CDLY}$ is 1V, $I_{CH-CDLY}$ is 0.25 μ A, C_{CDLY} is in Farads, t_{DELAY} is in seconds, and t_{DELAY+} is the internal propagation delay of the device. To ensure timing accuracy and proper operation, minimize leakage at $CDLY_+$.

Manual-Reset Input (\overline{MR})

Many μ P-based products require manual-reset capability, allowing the operator, a test technician, or external logic circuitry to initiate a reset. A logic-low on \overline{MR} asserts \overline{RESET} low. \overline{RESET} remains asserted while \overline{MR} is low and during the reset timeout period (140ms fixed or capacitor adjustable) after \overline{MR} returns high. The \overline{MR} input has a 500nA internal pullup, so it can be left unconnected, if not used. \overline{MR} can be driven with TTL or CMOS logic levels, or with open-drain/collector outputs. Connect a normally open momentary switch from \overline{MR} to GND to create a manual-reset function. External

debounce circuitry is not required. If \overline{MR} is driven from long cables or if the device is used in a noisy environment, connect a 0.1 μ F capacitor from \overline{MR} to GND to provide additional noise immunity.

Pullup Resistor Values

The exact value of the pullup resistors for the open-drain outputs is not critical, but some consideration should be made to ensure the proper logic levels when the device is sinking current. For example, if $V_{CC} = 2.25V$ and the pullup voltage is 28V, keep the sink current less than 0.5mA as shown in the *Electrical Characteristics* table. As a result, the pullup resistor should be greater than 56k Ω . For a 12V pullup, the resistor should be larger than 24k Ω . Note that the ability to sink current is dependent on the V_{CC} supply voltage.

Power-Supply Bypassing

The device operates with a V_{CC} supply voltage from 2.2V to 28V. When V_{CC} falls below the UVLO threshold, all the outputs go low and stay low until V_{CC} falls below 1.2V. For noisy systems or fast rising transients on V_{CC} , connect a 0.1 μ F ceramic capacitor from V_{CC} to GND as close to the device as possible to provide better noise and transient immunity.

Ensuring Valid Output with V_{CC} Down to 0V (MAX16026/MAX16028/MAX16030 Only)

When V_{CC} falls below 1.2V, the ability for the output to sink current decreases. In order to ensure a valid output as V_{CC} falls to 0V, connect a 100k Ω resistor from OUT/\overline{RESET} to GND.

Typical Application Circuits

Figures 4 and 5 show typical applications for the MAX16025-MAX16030. In high-power applications, using an n-channel device reduces the loss across the MOSFETs as it offers a lower drain-to-source on-resistance. However, an n-channel MOSFET requires a sufficient V_{GS} voltage to fully enhance it for a low $R_{DS(on)}$. The application in Figure 4 shows the MAX16027 configured in a multiple-output sequencing application. Figure 5 shows the MAX16029 in a power-supply sequencing application using n-channel MOSFETs.

Dual-/Triple-/Quad-Voltage, Capacitor-Adjustable, Sequencing/Supervisory Circuits

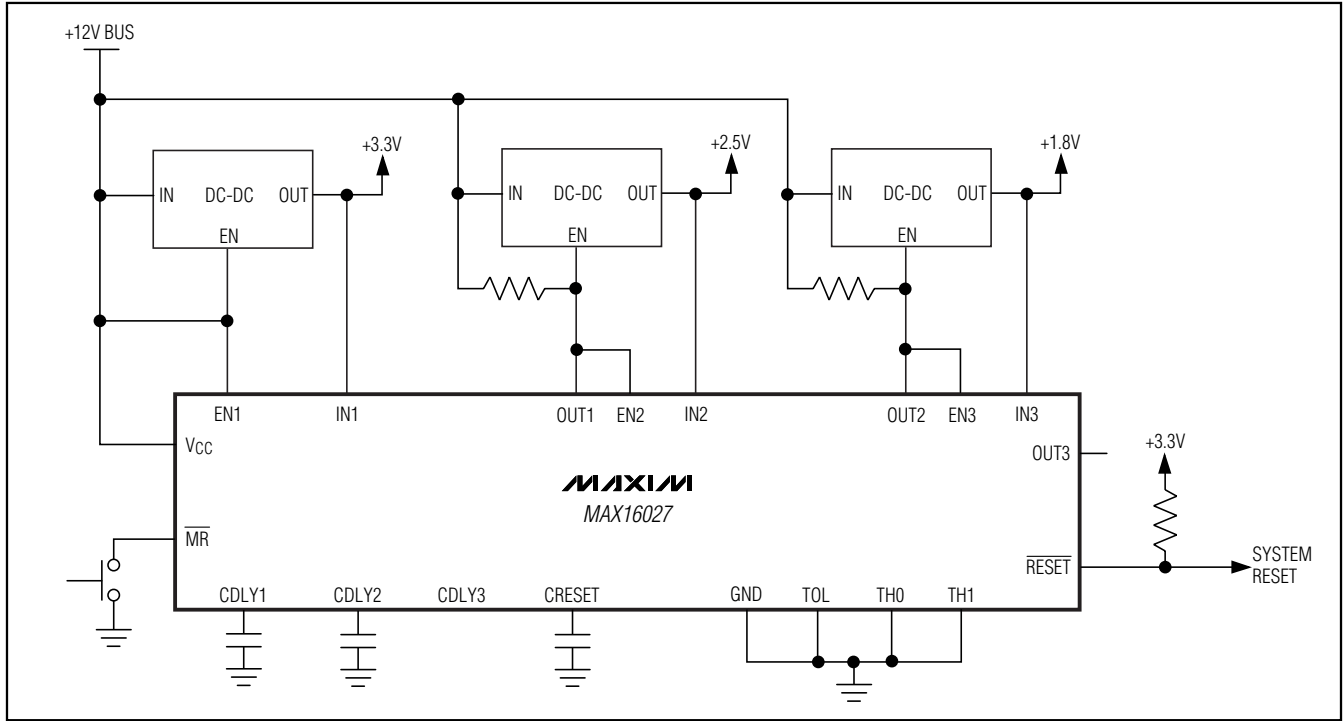

Figure 4. Sequencing Multiple-Voltage System

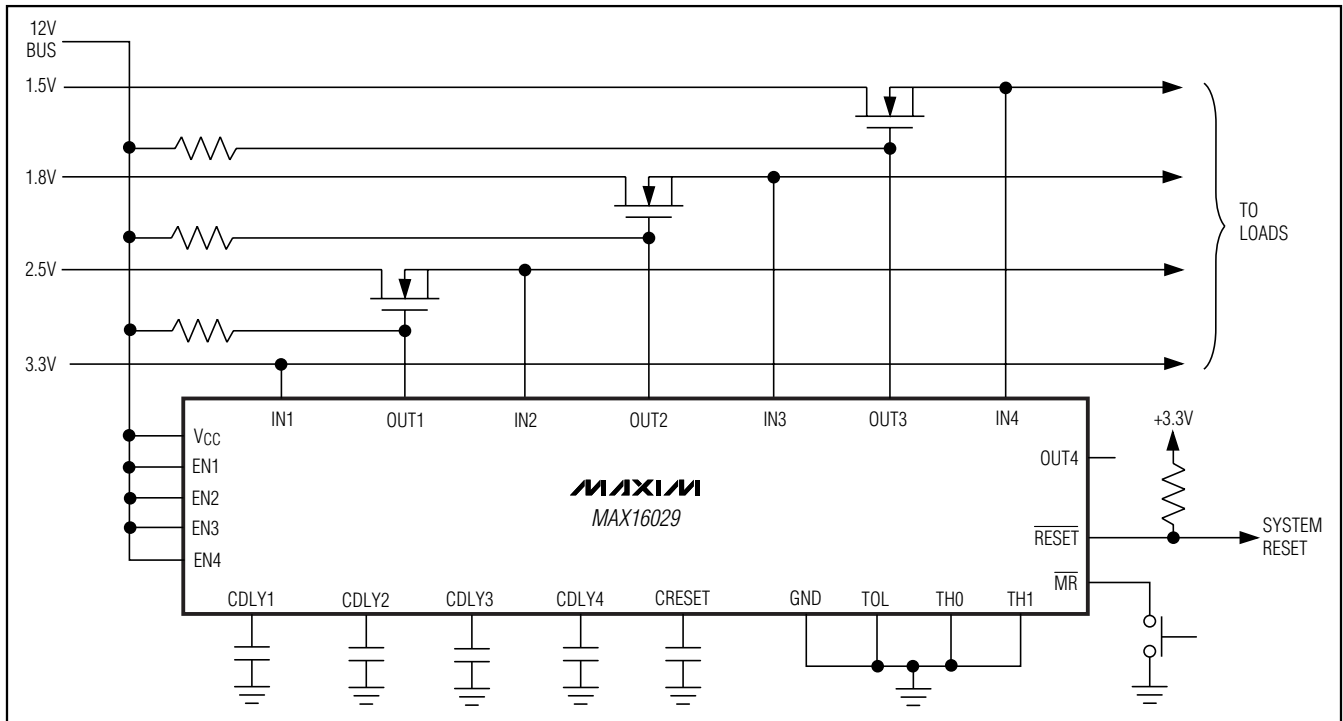
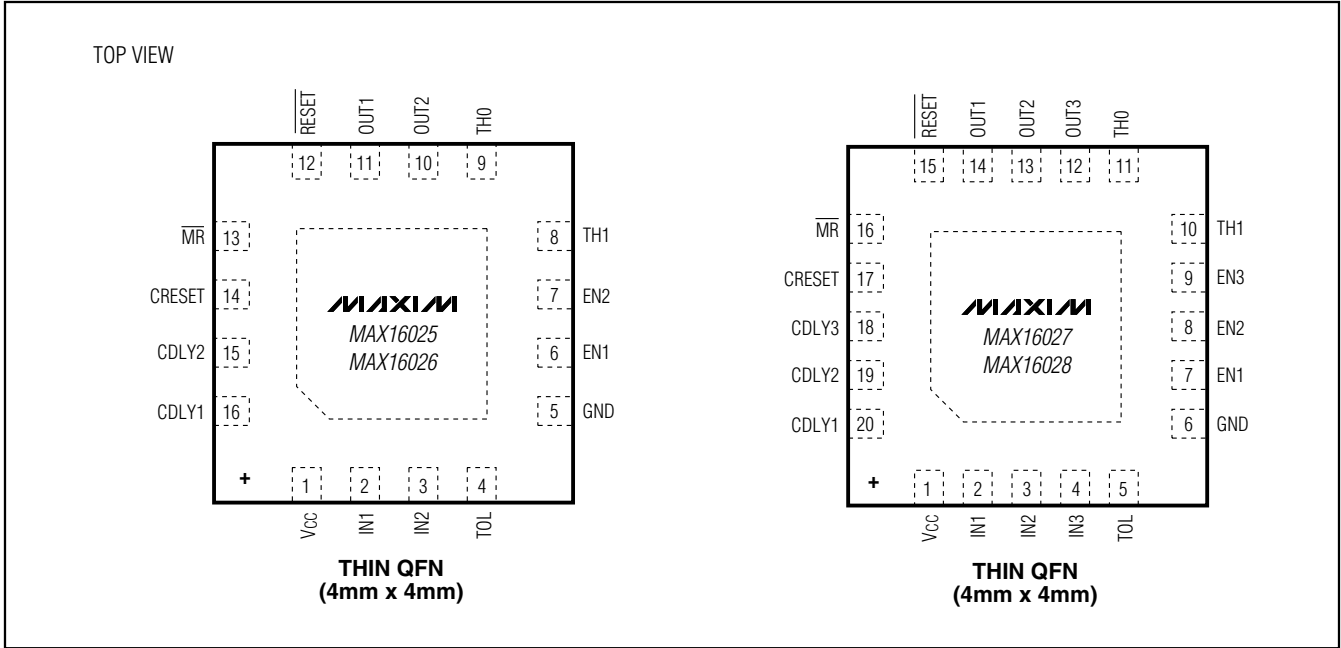

Figure 5. Multiple-Voltage Sequencing Using n-Channel FETs

Dual-/Triple-/Quad-Voltage, Capacitor-Adjustable, Sequencing/Supervisory Circuits

Pin Configurations (continued)

MAX16025-MAX16030



Chip Information

PROCESS: BICMOS

TRANSISTOR COUNT: 3642

Dual-/Triple-/Quad-Voltage, Capacitor-Adjustable, Sequencing/Supervisory Circuits

Package Information

(The package drawing(s) in this data sheet may not reflect the most current specifications. For the latest package outline information go to www.maxim-ic.com/packages.)

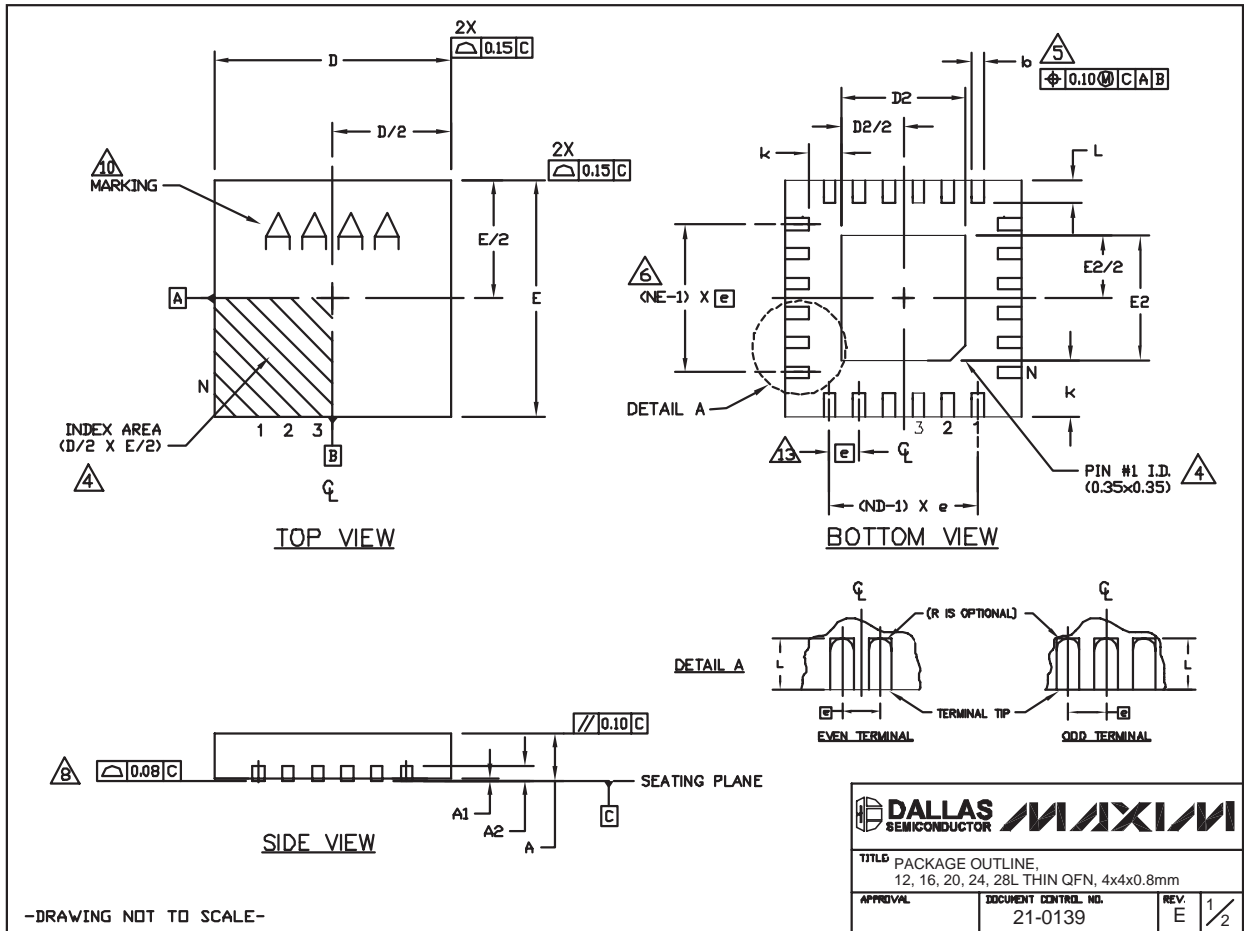

24L QFN THIN.EPS

Dual-/Triple-/Quad-Voltage, Capacitor-Adjustable, Sequencing/Supervisory Circuits

Package Information (continued)

(The package drawing(s) in this data sheet may not reflect the most current specifications. For the latest package outline information go to www.maxim-ic.com/packages.)

MAX16025-MAX16030

| COMMON DIMENSIONS | | | | | | | | | | | | | | | EXPOSED PAD VARIATIONS | | | | | | | | | |
|-------------------|-----------|------|------|-----------|------|------|-----------|------|------|-----------|------|------|-----------|------|------------------------|------------|------|------|------|------|------|------|--------------------|--|
| PKG | 12L 4x4 | | | 16L 4x4 | | | 20L 4x4 | | | 24L 4x4 | | | 28L 4x4 | | | PKG. CODES | D2 | | | E2 | | | DOWN BONDS ALLOWED | |
| REF. | MIN. | NOM. | MAX. | MIN. | NOM. | MAX. | MIN. | NOM. | MAX. | MIN. | NOM. | MAX. | MIN. | NOM. | MAX. | | MIN. | NOM. | MAX. | MIN. | NOM. | MAX. | | |
| A | 0.70 | 0.75 | 0.80 | 0.70 | 0.75 | 0.80 | 0.70 | 0.75 | 0.80 | 0.70 | 0.75 | 0.80 | 0.70 | 0.75 | 0.80 | T1244-3 | 1.95 | 2.10 | 2.25 | 1.95 | 2.10 | 2.25 | YES | |
| A1 | 0.0 | 0.02 | 0.05 | 0.0 | 0.02 | 0.05 | 0.0 | 0.02 | 0.05 | 0.0 | 0.02 | 0.05 | 0.0 | 0.02 | 0.05 | T1244-4 | 1.95 | 2.10 | 2.25 | 1.95 | 2.10 | 2.25 | NO | |
| A2 | 0.20 REF | | | 0.20 REF | | | 0.20 REF | | | 0.20 REF | | | 0.20 REF | | | T1644-3 | 1.95 | 2.10 | 2.25 | 1.95 | 2.10 | 2.25 | YES | |
| b | 0.25 | 0.30 | 0.35 | 0.25 | 0.30 | 0.35 | 0.20 | 0.25 | 0.30 | 0.18 | 0.23 | 0.30 | 0.15 | 0.20 | 0.25 | T1644-4 | 1.95 | 2.10 | 2.25 | 1.95 | 2.10 | 2.25 | NO | |
| D | 3.90 | 4.00 | 4.10 | 3.90 | 4.00 | 4.10 | 3.90 | 4.00 | 4.10 | 3.90 | 4.00 | 4.10 | 3.90 | 4.00 | 4.10 | T2044-2 | 1.95 | 2.10 | 2.25 | 1.95 | 2.10 | 2.25 | YES | |
| E | 3.90 | 4.00 | 4.10 | 3.90 | 4.00 | 4.10 | 3.90 | 4.00 | 4.10 | 3.90 | 4.00 | 4.10 | 3.90 | 4.00 | 4.10 | T2044-3 | 1.95 | 2.10 | 2.25 | 1.95 | 2.10 | 2.25 | NO | |
| e | 0.80 BSC. | | | 0.65 BSC. | | | 0.50 BSC. | | | 0.50 BSC. | | | 0.40 BSC. | | | T2444-2 | 1.95 | 2.10 | 2.25 | 1.95 | 2.10 | 2.25 | YES | |
| k | 0.25 | - | - | 0.25 | - | - | 0.25 | - | - | 0.25 | - | - | 0.25 | - | - | T2444-3 | 2.45 | 2.60 | 2.63 | 2.45 | 2.60 | 2.63 | YES | |
| L | 0.45 | 0.55 | 0.65 | 0.45 | 0.55 | 0.65 | 0.45 | 0.55 | 0.65 | 0.30 | 0.40 | 0.50 | 0.30 | 0.40 | 0.50 | T2444-4 | 2.45 | 2.60 | 2.63 | 2.45 | 2.60 | 2.63 | NO | |
| N | 12 | | | 16 | | | 20 | | | 24 | | | 28 | | | T2844-1 | 2.50 | 2.60 | 2.70 | 2.50 | 2.60 | 2.70 | NO | |
| ND | 3 | | | 4 | | | 5 | | | 6 | | | 7 | | | | | | | | | | | |
| NE | 3 | | | 4 | | | 5 | | | 6 | | | 7 | | | | | | | | | | | |
| JEDEC Ref. | VGG3 | | | VGGC | | | WGGD-1 | | | WGGD-2 | | | VGGE | | | | | | | | | | | |

NOTES:

- DIMENSIONING & TOLERANCING CONFORM TO ASME Y14.5M-1994.
- ALL DIMENSIONS ARE IN MILLIMETERS. ANGLES ARE IN DEGREES.
- N IS THE TOTAL NUMBER OF TERMINALS.
- THE TERMINAL #1 IDENTIFIER AND TERMINAL NUMBERING CONVENTION SHALL CONFORM TO JEDEC 95-1 SPP-012. DETAILS OF TERMINAL #1 IDENTIFIER ARE OPTIONAL, BUT MUST BE LOCATED WITHIN THE ZONE INDICATED. THE TERMINAL #1 IDENTIFIER MAY BE EITHER A MOLD OR MARKED FEATURE.
- DIMENSION b APPLIES TO METALLIZED TERMINAL AND IS MEASURED BETWEEN 0.25 mm AND 0.30 mm FROM TERMINAL TIP.
- ND AND NE REFER TO THE NUMBER OF TERMINALS ON EACH D AND E SIDE RESPECTIVELY.
- DEPOPULATION IS POSSIBLE IN A SYMMETRICAL FASHION.
- COPLANARITY APPLIES TO THE EXPOSED HEAT SINK SLUG AS WELL AS THE TERMINALS.
- DRAWING CONFORMS TO JEDEC MO220, EXCEPT FOR T2444-3, T2444-4 AND T2844-1.
- MARKING IS FOR PACKAGE ORIENTATION REFERENCE ONLY.
- COPLANARITY SHALL NOT EXCEED 0.08mm
- WARPAGE SHALL NOT EXCEED 0.10mm
- LEAD CENTERLINES TO BE AT TRUE POSITION AS DEFINED BY BASIC DIMENSION "e", ±0.05.
- NUMBER OF LEADS SHOWN ARE FOR REFERENCE ONLY

-DRAWING NOT TO SCALE-

| | |
|---|---------------------------------|
| | |
| TITLE PACKAGE OUTLINE, 12, 16, 20, 24, 28L THIN QFN, 4x4x0.8mm | |
| APPROVAL | DOCUMENT CONTROL NO. 21-0139 |
| REV. E | 2/2 |

Revision History

Pages changed at Rev 1: 1, 3, 15

Maxim cannot assume responsibility for use of any circuitry other than circuitry entirely embodied in a Maxim product. No circuit patent licenses are implied. Maxim reserves the right to change the circuitry and specifications without notice at any time.

Maxim Integrated Products, 120 San Gabriel Drive, Sunnyvale, CA 94086 408-737-7600 15

Looking for pricing, stock, or lifecycle information?

Click below to explore more details on WIN SOURCE:

 [View MAX16029TG+T on WIN SOURCE](#)

 [Maxim Integrated](#) Information

Optimize Your Supply Chain with WIN SOURCE Solutions

-  Global Sourcing Solution
-  Obsolete Management
-  Cost Control Management
-  Shortage Management
-  Alternative Solution
-  Excess Inventory Management