



**THE DATASHEET OF
MAX1562HESA+**

Programmable 4A USB Current-Limited Switches with Autoreset and Fault Blanking

General Description

The MAX1562/MAX1562H/MAX1563 single current-limited switches provide up to 4A to power up to eight USB ports. They operate from a 4V to 5.5V input supply and consume only 40 μ A of quiescent current when operating and only 3 μ A in shutdown.

The MAX1562/MAX1562H/MAX1563s' autoreset feature latches the switch off if the output is shorted, thereby saving system power. When the short is removed, the switch is reactivated. A fault-blanking feature enables the circuit to ignore momentary faults, such as those caused when hot swapping a capacitive load, preventing false alarms to the host system. Fault blanking also prevents fault signals from being issued when the device powers up the load.

The MAX1562/MAX1562H/MAX1563 provide several safety features to protect the USB port. Built-in thermal-overload protection turns off the switch when the die temperature exceeds +160°C. Accurate internal current-limiting circuitry protects the input supply against both overload and short-circuit conditions. An open-drain fault signal (FAULT) notifies the microprocessor when a thermal-overload, current-limit, undervoltage lockout (UVLO), or short-circuit fault occurs.

The MAX1562 has an active-low $\overline{\text{ON}}$, and the MAX1562H has an active-high ON enable input. The MAX1563 has a selectable active-high or active-low logic-controlled enable. The current limit is programmed from 1A to 4A using a resistor.

The MAX1562/MAX1562H are available in 8-pin SO packages and are pin-compatible upgrades to the MIC2545A/MIC2549A. The MAX1563 provides the same features and higher current performance in a smaller 12-pin (4mm x 4mm) Thin QFN package. These devices operate over an extended temperature range (-40°C to +85°C). An evaluation kit is available to speed designs.

Applications

- Notebook Computers
- Desktop Computers
- USB Ports and Hubs
- PDA's and Palmtop Computers
- Docking Stations

Pin Configurations appear at end of data sheet.

Features

- ◆ Programmable Current Limit (1A to 4A) with Resistor
- ◆ Autoreset Feature Saves System Power
- ◆ 20ms Fault-Blanking Circuitry
- ◆ Active-High/Low Control Logic
- ◆ Fault-Indicator Output
- ◆ Thermal-Overload Protection
- ◆ Smaller 4mm x 4mm Thin QFN Package (MAX1563)
- ◆ 3 μ A Shutdown Current

Ordering Information

| PART | TEMP RANGE | PIN-PACKAGE |
|--------------|----------------|-------------|
| MAX1562ESA+ | -40°C to +85°C | 8 SO |
| MAX1562HESA+ | -40°C to +85°C | 8 SO |
| MAX1563ETC+ | -40°C to +85°C | 12 TQFN-EP* |

+Denotes a lead(Pb)-free/RoHS-compliant package.

*EP = Exposed pad.

Typical Operating Circuit

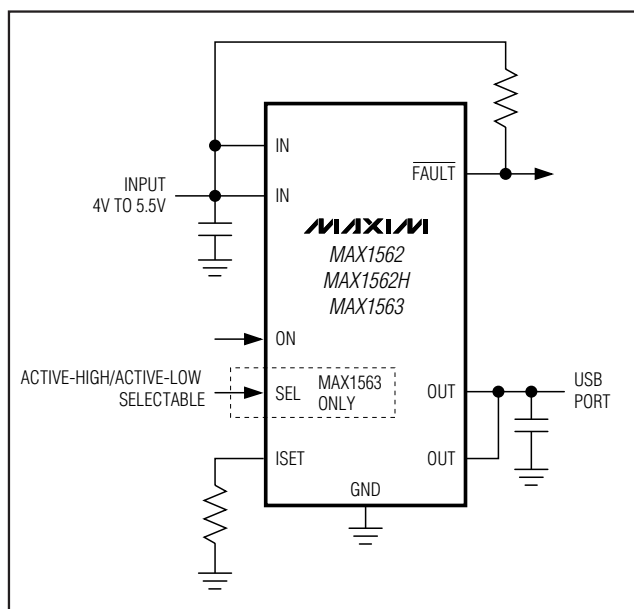

Programmable 4A USB Current-Limited Switches with Autoreset and Fault Blanking

ABSOLUTE MAXIMUM RATINGS

| | | |
|--|-----------------------------------|---|
| IN, ON, $\overline{\text{ON}}$, ISET, SEL, OUT to GND | -0.3V to +6V | 12-Pin Thin QFN (4mm x 4mm) |
| FAULT to GND | -0.3V to (V _{IN} + 0.3V) | (derate 16.9mW/°C above +70°C)..... |
| IN to OUT | -0.3V to +6V | 1350mW |
| OUT Maximum Continuous Switch Current | 5A | Operating Temperature Range |
| FAULT DC Current | 10mA | -40°C to +85°C |
| Continuous Power Dissipation | | Junction Temperature |
| 8-Pin SO (derate 5.9mW/°C above +70°C)..... | 471mW | +150°C |
| | | Storage Temperature Range |
| | | -65°C to +150°C |
| | | Lead Temperature (soldering, 10s) |
| | | +300°C |

Stresses beyond those listed under "Absolute Maximum Ratings" may cause permanent damage to the device. These are stress ratings only, and functional operation of the device at these or any other conditions beyond those indicated in the operational sections of the specifications is not implied. Exposure to absolute maximum rating conditions for extended periods may affect device reliability.

ELECTRICAL CHARACTERISTICS

(V_{IN} = +5V, C_{IN} = 1μF, C_{OUT} = 4.7μF, T_A = 0°C to +85°C, unless otherwise noted. Typical values are at T_A = +25°C.)

| PARAMETER | SYMBOL | CONDITIONS | MIN | TYP | MAX | UNITS | |
|--|-------------------|--|---|------|-----|-------|---------|
| Supply Voltage Range | V _{IN} | | 4.0 | | 5.5 | V | |
| Switch On-Resistance | R _{ON} | | | 26 | 50 | mΩ | |
| Standby Supply Current | | Switch disabled | | 3 | 10 | μA | |
| Quiescent Supply Current | I _{IN} | Switch enabled, I _{OUT} = 0A | | 40 | 80 | μA | |
| OUT Off-Leakage Current | I _{LKG} | Switch disabled, V _{OUT} = 0V | | 0.02 | 10 | μA | |
| Undervoltage-Lockout Threshold | V _{UVLO} | Rising edge, 3% hysteresis | 2.9 | 3.4 | 3.8 | V | |
| Continuous Current-Limit Adjust Range | | MAX1563 | 1 | | 4 | A | |
| | | MAX1562/MAX1562H | 1 | | 3 | | |
| Continuous Current Limit | I _{LIM} | V _{IN} - V _{OUT} = 0.5V | R _{ISET} = 4.22kΩ (MAX1563 only) | 3.2 | 4 | 4.8 | A |
| | | | R _{ISET} = 5.76kΩ | 2.4 | 3 | 3.6 | |
| | | | R _{ISET} = 8kΩ | 1.7 | 2.1 | 2.6 | |
| | | | R _{ISET} = 12kΩ | 1.1 | 1.4 | 1.7 | |
| Short-Circuit Current Limit | I _{LIM} | V _{OUT} = 0V, I _{OUT} pulsing | R _{ISET} = 4.22kΩ (MAX1563 only) | | 4.9 | | A(peak) |
| | | | | | | 1.6 | |
| | | | R _{ISET} = 5.76kΩ | 2.5 | 3.6 | 4.7 | A(peak) |
| | | | | | 1.4 | | A(RMS) |
| | | | R _{ISET} = 12kΩ | 1.2 | 1.7 | 2.3 | A(peak) |
| | | | | | 0.4 | | A(RMS) |
| Short-Circuit Detect Threshold | | (Note 1) | | 1 | | V | |
| Continuous Current-Limit Blanking Timeout Period | | From continuous current-limit condition to $\overline{\text{FAULT}}$ asserted | 10 | 20 | 35 | ms | |
| Short-Circuit Blanking Timeout Period | | From short-circuit current-limit condition to $\overline{\text{FAULT}}$ asserted | 7.5 | 18 | 35 | ms | |
| Turn-On Delay | t _{ON} | R _{OUT} = 2Ω, C _{OUT} = 4.7μF (from ON to 10% of V _{OUT}) | 0.5 | 1.2 | 4.0 | ms | |
| Output Rise Time | t _{RISE} | R _{OUT} = 2Ω, C _{OUT} = 4.7μF (from 10% to 90% of V _{OUT}) | | 2.5 | | ms | |
| Turn-Off Delay | t _{OFF} | R _{OUT} = 2Ω, C _{OUT} = 4.7μF (from ON to 90% of V _{OUT}) | | 0.1 | 3 | ms | |

Programmable 4A USB Current-Limited Switches with Autoreset and Fault Blanking

MAX1562/MAX1562H/MAX1563

ELECTRICAL CHARACTERISTICS (continued)

($V_{IN} = +5V$, $C_{IN} = 1\mu F$, $C_{OUT} = 4.7\mu F$, $T_A = 0^\circ C$ to $+85^\circ C$, unless otherwise noted. Typical values are at $T_A = +25^\circ C$.)

| PARAMETER | SYMBOL | CONDITIONS | MIN | TYP | MAX | UNITS |
|---|------------|---|------|------|------|---------|
| Output Fall Time | t_{FALL} | $R_{OUT} = 2\Omega$, $C_{OUT} = 4.7\mu F$ (from 90% to 10% of V_{OUT}) | | 0.8 | | ms |
| Thermal-Shutdown Threshold | | 15°C hysteresis | | +160 | | °C |
| ON, \overline{ON} , SEL Input High Level | V_{IH} | $V_{IN} = +4V$ to $+5.5V$ | 2 | | | V |
| ON, \overline{ON} , SEL Input Low Level | V_{IL} | $V_{IN} = +4V$ to $+5.5V$ | | | 0.8 | V |
| ON, \overline{ON} , SEL Input Leakage Current | | | -1 | | +1 | μA |
| \overline{FAULT} Output Low Voltage | V_{OL} | $I_{SINK} = 1mA$, $V_{IN} = +4V$ | | | 0.4 | V |
| \overline{FAULT} Output High Leakage Current | | $V_{IN} = V_{\overline{FAULT}} = +5.5V$ | | | 1 | μA |
| OUT Autoreset Current | | In latched-off state, $V_{OUT} = 0V$ | 10 | 25 | 45 | mA |
| OUT Autoreset Threshold | | In latched-off state, OUT rising | 0.35 | 0.5 | 0.65 | V |
| OUT Autoreset Blanking Time | | In latched-off state, $V_{OUT} > 0.5V$ | 10 | 20 | 35 | ms |

ELECTRICAL CHARACTERISTICS

($V_{IN} = +5V$, $C_{IN} = 1\mu F$, $C_{OUT} = 4.7\mu F$, $T_A = -40^\circ C$ to $+85^\circ C$, unless otherwise noted.) (Note 2)

| PARAMETER | SYMBOL | CONDITIONS | MIN | TYP | MAX | UNITS | |
|--|------------|---|---|-----|-----|-----------|---------|
| Supply Voltage Range | V_{IN} | | 4.0 | | 5.5 | V | |
| Switch On-Resistance | R_{ON} | | | | 50 | $m\Omega$ | |
| Standby Supply Current | | Switch disabled | | | 10 | μA | |
| Quiescent Supply Current | I_{IN} | Switch enabled, $I_{OUT} = 0A$ | | | 80 | μA | |
| OUT Off-Leakage Current | I_{LKG} | Switch disabled, $V_{OUT} = 0V$ | | | 10 | μA | |
| UVLO Threshold | V_{UVLO} | Rising edge, 3% hysteresis | 2.9 | | 3.8 | V | |
| Continuous Current-Limit Adjust Range | | MAX1563 | 1 | | 4 | A | |
| | | MAX1562/MAX1562H | 1 | | 3 | | |
| Continuous Current Limit | I_{LIM} | $V_{IN} - V_{OUT} = 0.5V$ | $R_{ISET} = 4.22k\Omega$ (MAX1563 only) | | | 4.9 | A |
| | | | $R_{ISET} = 5.76k\Omega$ | 2.3 | | 3.7 | |
| | | | $R_{ISET} = 8k\Omega$ | 1.6 | | 2.7 | |
| | | | $R_{ISET} = 12k\Omega$ | 1.0 | | 1.8 | |
| Short-Circuit Current Limit | I_{LIM} | $V_{OUT} = 0V$, I_{OUT} pulsing | $R_{ISET} = 5.76k\Omega$ | 2.4 | | 4.8 | A(peak) |
| | | | $R_{ISET} = 12k\Omega$ | 1.1 | | 2.4 | |
| Continuous Current-Limit Blanking Timeout Period | | From continuous current-limit condition to \overline{FAULT} asserted | 10 | | 35 | ms | |
| Short-Circuit Blanking Timeout Period | | From short-circuit current-limit condition to \overline{FAULT} asserted | 7.5 | | 35 | ms | |

Programmable 4A USB Current-Limited Switches with Autoreset and Fault Blanking

ELECTRICAL CHARACTERISTICS (continued)

($V_{IN} = +5V$, $C_{IN} = 1\mu F$, $C_{OUT} = 4.7\mu F$, $T_A = -40^\circ C$ to $+85^\circ C$, unless otherwise noted.) (Note 2)

| PARAMETER | SYMBOL | CONDITIONS | MIN | TYP | MAX | UNITS |
|---|-----------|--|------|-----|------|---------|
| Turn-On Delay | t_{ON} | $R_{OUT} = 2\Omega$, $C_{OUT} = 4.7\mu F$ (from ON to 10% of V_{OUT}) | 0.5 | | 4.0 | ms |
| Turn-Off Delay | t_{OFF} | $R_{OUT} = 2\Omega$, $C_{OUT} = 4.7\mu F$ (from ON to 90% of V_{OUT}) | | | 3 | ms |
| ON, \overline{ON} , SEL Input High Level | V_{IH} | $V_{IN} = +4V$ to $+5.5V$ | 2 | | | V |
| ON, \overline{ON} , SEL Input Low Level | V_{IL} | $V_{IN} = +4V$ to $+5.5V$ | | | 0.8 | V |
| ON, \overline{ON} , SEL Input Leakage Current | | | -1 | | +1 | μA |
| \overline{FAULT} Output Low Voltage | V_{OL} | $I_{SINK} = 1mA$, $V_{IN} = +4V$ | | | 0.4 | V |
| \overline{FAULT} Output High Leakage Current | | $V_{IN} = V_{\overline{FAULT}} = +5.5V$ | | | 1 | μA |
| OUT Autoreset Current | | In latched-off state, $V_{OUT} = 0V$ | 10 | | 45 | mA |
| OUT Autoreset Threshold | | In latched-off state, OUT rising | 0.35 | | 0.65 | V |
| OUT Autoreset Blanking Time | | In latched-off state, $V_{OUT} > 0.5V$ | 10 | | 35 | ms |

Note 1: Short-circuit detect threshold is the output voltage at which the device transitions from short-circuit current limit to continuous current limit.

Note 2: Specifications to $-40^\circ C$ are guaranteed by design, not production tested.

Typical Operating Characteristics

($V_{IN} = +5V$, $C_{IN} = 1\mu F$, $C_{OUT} = 4.7\mu F$, $T_A = +25^\circ C$, unless otherwise noted.)

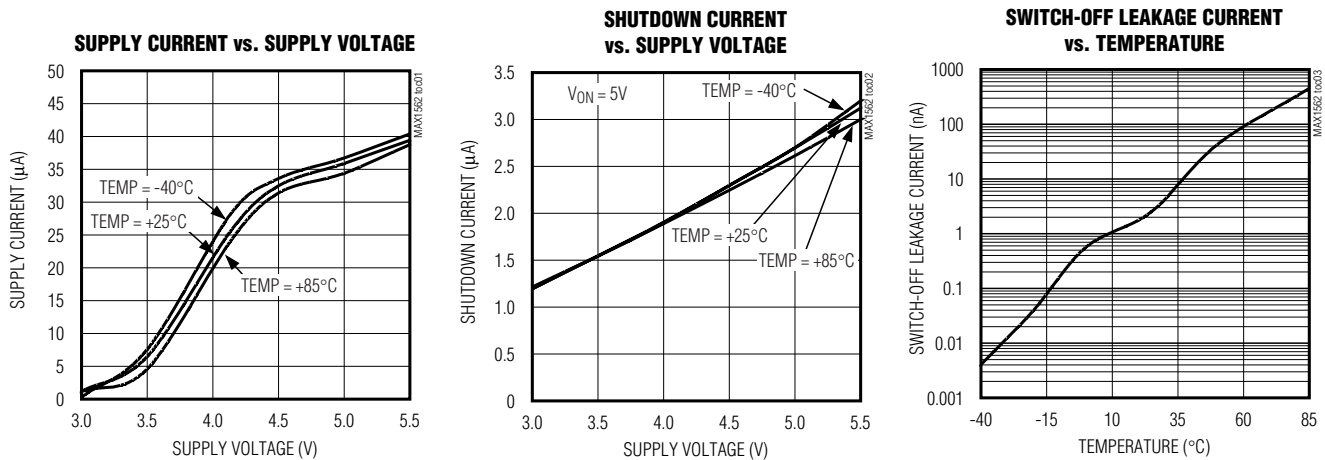

Programmable 4A USB Current-Limited Switches with Autoreset and Fault Blanking

Typical Operating Characteristics (continued)

($V_{IN} = +5V$, $C_{IN} = 1\mu F$, $C_{OUT} = 4.7\mu F$, $T_A = +25^\circ C$, unless otherwise noted.)

MAX1562/MAX1562H/MAX1563

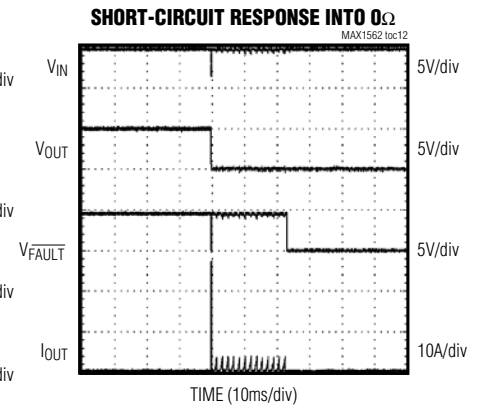
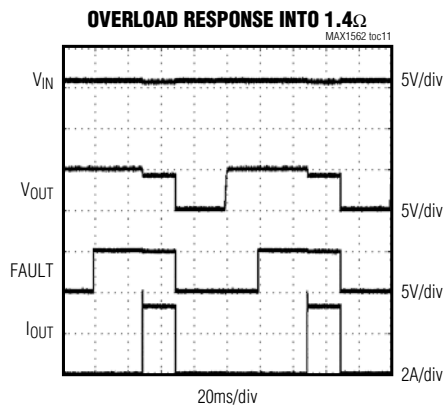
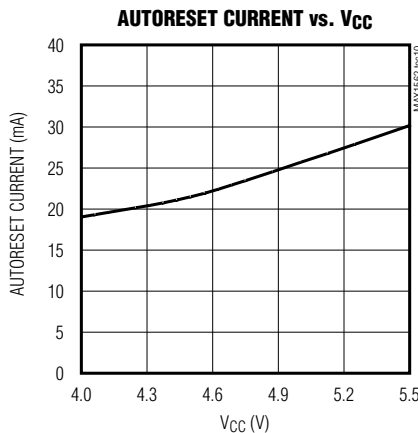
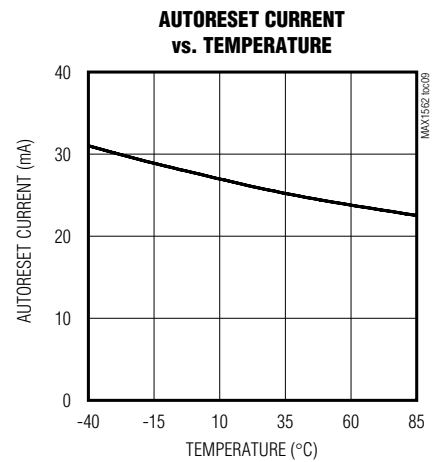
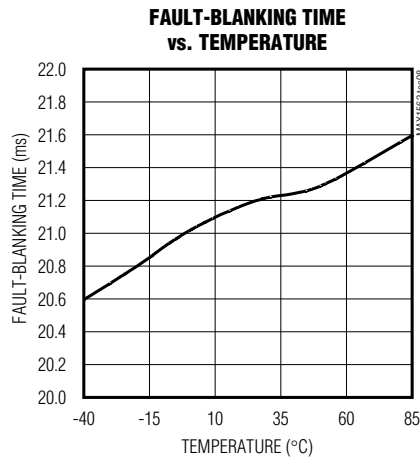
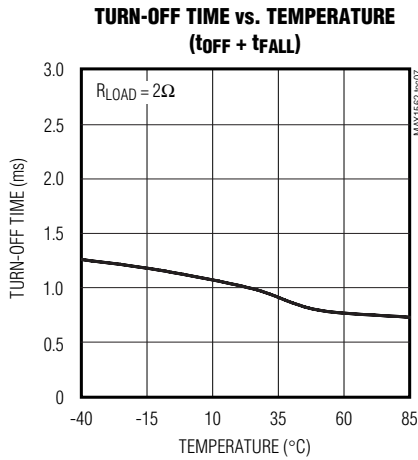
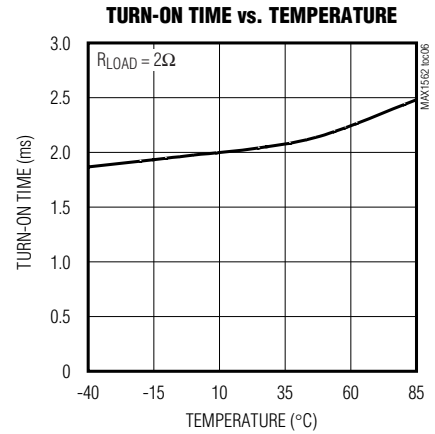
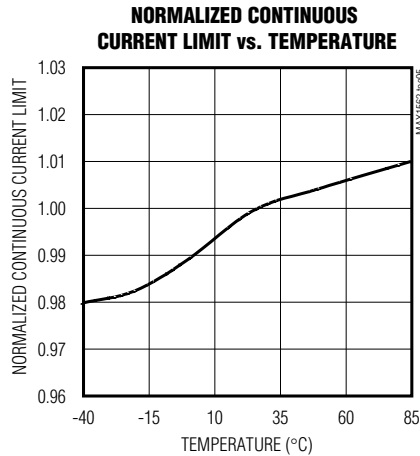
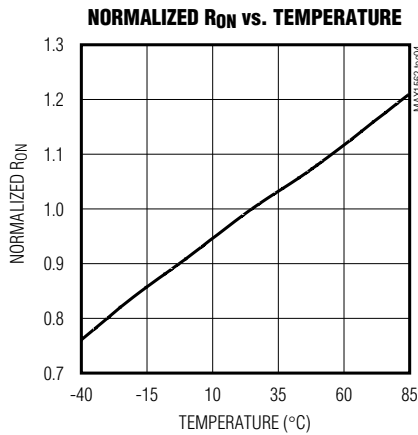

Programmable 4A USB Current-Limited Switches with Autoreset and Fault Blanking

Typical Operating Characteristics (continued)

($V_{IN} = +5V$, $C_{IN} = 1\mu F$, $C_{OUT} = 4.7\mu F$, $T_A = +25^\circ C$, unless otherwise noted.)

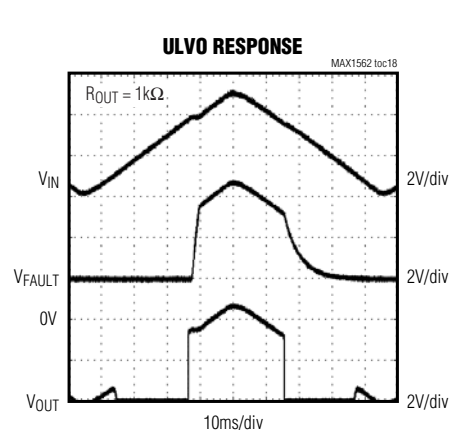
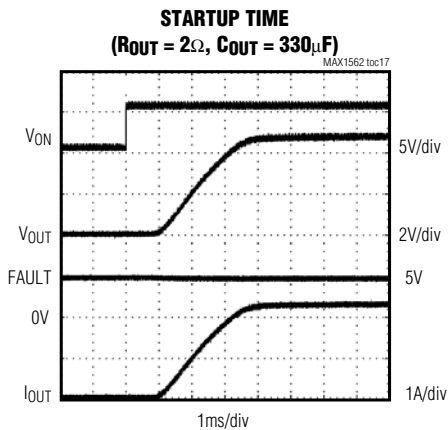
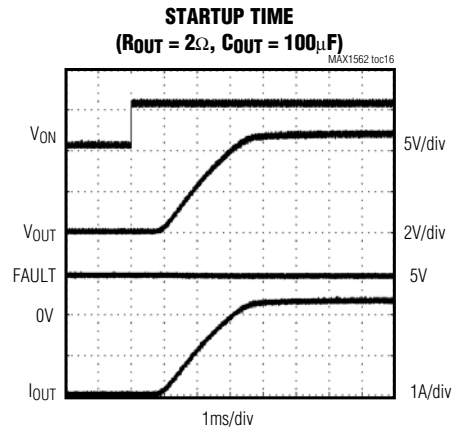
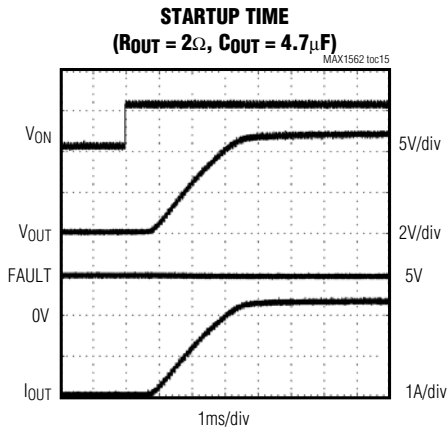
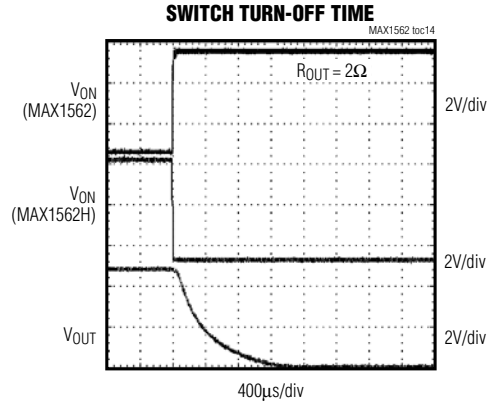
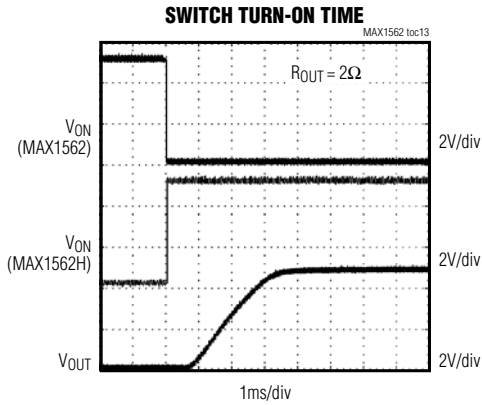

Programmable 4A USB Current-Limited Switches with Autoreset and Fault Blanking

Pin Description

| PIN | | NAME | FUNCTION |
|---------------------------|----------------------|-------------------------------|--|
| MAX1562 MAX1562H SO | MAX1563 (TQFN-EP) | | |
| 1 | 4 | ON ($\overline{\text{ON}}$) | Switch On/Off Control Input. The active polarity of ON is low for the MAX1562 and high for the MAX1562H. For the MAX1563, the active polarity of ON is set by SEL. |
| 2 | 5 | $\overline{\text{FAULT}}$ | Fault Indicator Output. $\overline{\text{FAULT}}$ is an open-drain output that asserts low when the switch enters a sustained (>20ms) current limit. FAULT goes low immediately during thermal shutdown or an undervoltage input. Note that during severe short conditions, $\overline{\text{FAULT}}$ goes low immediately since there is typically also a brief undervoltage transient. |
| 3 | 6 | GND | Ground |
| 4 | 7 | ISET | Current-Limit Input. Connect an external resistor from ISET to GND to set current limit, where $I_{\text{LIM}} = 17120 / R_{\text{ISET}}$. |
| 5, 7 | 9, 12 | IN | Power Input for Switch. Connect both IN inputs together and bypass with a 1 μ F ceramic capacitor to GND. Load conditions might require additional bulk capacitance to prevent fluctuation on the input source. |
| 6, 8 | 1, 10 | OUT | Power Output for Switch. Bypass OUT to GND with a 4.7 μ F ceramic capacitor. Load conditions might require additional bulk capacitance. When disabled, OUT goes into a high-impedance state. |
| — | 2, 8, 11 | N.C. | No Connection. Internally unconnected. Leave unconnected or use with other traces to simplify PC board layout. |
| — | 3 | SEL | Polarity Control Input for ON. Drive SEL high for active-high enable. Drive SEL low for active-low enable. |
| — | — | EP | Exposed Pad. Internally connected to GND. Connect to a large ground plane with multiple vias to manage thermal performance. Not intended as an electrical connection point. |

Detailed Description

The MAX1562/MAX1562H/MAX1563 family comprises a programmable current-limited switch designed for USB and hot-swap applications. The MAX1563 can be programmed for loads up to 4A, and the MAX1562/MAX1562H can be programmed for loads up to 3A. The current limit is programmed using a single resistor. A fault output notifies the host when the current-limit, short-circuit, UVLO, or thermal-shutdown threshold is exceeded.

A built-in current limit protects the load and the source in the event of an overload condition. In addition, a built-in short-circuit detection circuit pulses the output if the output is less than 1V (typ), resulting in a lower RMS output current and reduced power dissipation in the device. Thermal shutdown protects the device in the event of a prolonged overload or short-circuit condition.

An internal micropower charge pump generates the high-side supply needed for driving the gate of the internal low- R_{ON} NMOS switch.

Fault blanking allows the MAX1562/MAX1562H/MAX1563 family to handle USB loads that may not be fully compliant with USB specifications. USB loads with additional bypass capacitance or large startup currents can be successfully powered while protecting the upstream power source. If the switch brings up the load within the blanking period (20ms typ), FAULT is not asserted. In the event of a current-limit event, current through the switch is regulated at the current-limit target. Below approximately 1V, the short-circuit current limit is 30% higher than the programmed current limit.

Current-Limit Programming

The MAX1562/MAX1562H/MAX1563 continuous current limit is set by selecting the value of R_{ISET} based on the

MAX1562/MAX1562H/MAX1563

Programmable 4A USB Current-Limited Switches with Autoreset and Fault Blanking

following equation:

$$I_{LIM} = 17120 / R_{ISET}$$

Choose R_{ISET} with resistor values between 4.22k Ω to 16k Ω . Resistor values greater than 16k Ω significantly degrade current-limit accuracy. For the MAX1562/MAX1562H, the minimum R_{ISET} value is 5.76k Ω . This corresponds to a 3A current limit, which is limited by the 8-pin SO's maximum power dissipation. For the MAX1563, the minimum R_{ISET} value is 4.22k Ω , corresponding to a 4A current limit. Set the continuous current-limit value 20% to 30% higher than the expected load current to ensure that normal conditions do not trigger nuisance fault outputs. The short-circuit current limit is internally set to 1.3 times the continuous current-limit setting.

On/Off Control and UVLO

The MAX1562 has an active-low \overline{ON} polarity and the MAX1562H has an active-high ON polarity. SEL sets the active polarity of the MAX1563. Connect ON to the same voltage as SEL to enable OUT. Connect ON to the opposite voltage as SEL to disable OUT (see Table 1).

Table 1. On/Off Control

| SEL | ON | OUT BEHAVIOR |
|----------|----------|--------------|
| GND | GND | ON |
| | V_{IN} | OFF |
| V_{IN} | GND | OFF |
| | V_{IN} | ON |

The MAX1562/MAX1562H/MAX1563 include a UVLO circuit to prevent erroneous switch operation when the input voltage goes low during startup and brownout conditions. Input voltages of less than +3.4V inhibit operation of the device. \overline{FAULT} asserts low during a UVLO condition.

Output Fault Protection and Autoreset

The MAX1562/MAX1562H/MAX1563 sense the switch output voltage and select continuous current limiting for V_{OUT} greater than 1V or short-circuit current limiting for V_{OUT} less than 1V. When V_{OUT} is greater than 1V, the device operates in a continuous current-limit mode that limits output current to the programmed current limit (1A to 4A). When V_{OUT} is less than 1V, the device operates in short-circuit current-limit mode, sourcing a pulsed current to the load. The pulse current depends on the programmed current-limit value, typically 30% higher than the programmed current limit.

When either fault condition persists for 20ms, the output turns off and the fault flag asserts. The output automatically restarts when the short or overload is removed. Note

that during severe short conditions, \overline{FAULT} does not wait 20ms but goes low immediately since there is typically also an undervoltage transient during a severe short.

The MAX1562/MAX1562H/MAX1563 detect short-circuit removal by sourcing 25mA from the output and monitoring the output voltage. When the voltage at the output exceeds +0.5V for 20ms, the fault flag resets, the output turns back on, and the 25mA current source turns off.

Thermal Shutdown

When the MAX1562/MAX1562H/MAX1563 die temperature exceeds +160°C, the switch turns off and \overline{FAULT} goes low. Thermal shutdown does not utilize the 20ms fault-blanking timeout period. When the junction temperature cools by 15°C, the switch turns on again and \overline{FAULT} returns high. The switch cycles on and off if an overload condition persists, resulting in a pulsed output that reduces the average system load.

Fault Indicators

The MAX1562/MAX1562H/MAX1563 provide an open-drain fault output, \overline{FAULT} . Connect \overline{FAULT} to IN through a 100k Ω pullup resistor for most applications. \overline{FAULT} asserts low when any of the following conditions occur:

- The input voltage is below the UVLO threshold.
- The switch junction temperature exceeds the +160°C thermal-shutdown temperature limit.
- The switch is in current-limit or short-circuit current-limit mode for more than 20ms.

The \overline{FAULT} output deasserts after a 20ms delay once the fault condition is removed. Ensure that the MAX1562/MAX1562H/MAX1563 input bypass capacitance is sufficiently large to prevent load glitches from triggering the \overline{FAULT} output. Limit the input-voltage slew rate to 0.2V/ μ s to prevent erroneous \overline{FAULT} indications.

To differentiate large capacitive loads from short circuits or sustained overloads, the switches have a fault-blanking circuit. When a load transient causes the device to enter current limit, an internal counter monitors the duration of the fault. For load faults exceeding the 20ms fault-blanking time, the switch turns off, \overline{FAULT} asserts low, and the device enters autoreset mode (see the *Output Fault Protection and Autoreset* section). Only current-limit and short-circuit faults are blanked. If thermal-overload faults or the input voltage drops below the UVLO threshold, the switch turns off and asserts \overline{FAULT} low immediately. Note that during severe short conditions, \overline{FAULT} goes low immediately since there is typically also a brief undervoltage transient.

Fault blanking allows the MAX1562/MAX1562H/MAX1563 to handle USB loads that might not be fully compliant with the USB specifications. These switches

Programmable 4A USB Current-Limited Switches with Autoreset and Fault Blanking

MAX1562/MAX1562H/MAX1563

Table 2. Current Limiting and Fault Behavior

| CONDITION | MAX1562/MAX1562H/MAX1563 BEHAVIOR |
|--|---|
| Output Short-Circuit ($V_{OUT} < +1V$) | <ul style="list-style-type: none"> If a short is detected at the output, the channel turns off, and the blanking timer begins. \overline{FAULT} remains high during the blanking timeout period. If the short persists during the fault-blanking period, the output pulses at $0.30 \times I_{LIM}$ RMS. If the short is removed before the 20ms short-circuit blanking timeout period, the next ramped current pulse soft-starts the output. \overline{FAULT} remains high. If the short-circuit persists after the fault-blanking period, \overline{FAULT} goes low, autoreset mode begins, and the output sources 25mA. If the output voltage rises above 0.5V for 20ms, the channel resets, the output turns on, and \overline{FAULT} goes high. |
| Output Overload Current ($V_{OUT} > +1V$) | <ul style="list-style-type: none"> If an overload occurs, output current regulates at I_{LIM} and the blanking timer turns on. \overline{FAULT} remains high during the blanking timeout period. Continuous current at I_{LIM} persists until either the 20ms blanking period expires or a thermal fault occurs. If overcurrent persists after 20ms, \overline{FAULT} goes low, autoreset mode is enabled, and the output sources 25mA. If the output voltage rises above 0.5V for 20ms, the channel resets, the output turns on, and \overline{FAULT} goes high (see the Overload Response into 1.4Ω graph in the <i>Typical Operating Characteristics</i> section). |
| Thermal Fault ($T_J > +160^\circ C$) | <ul style="list-style-type: none"> A junction temperature of $+160^\circ C$ immediately asserts \overline{FAULT} low (the blanking timeout period does not apply for thermal faults) and turns off the switch. When the junction cools by $15^\circ C$, the thermal fault is cleared and \overline{FAULT} goes high. Note that if other fault conditions are present when a thermal fault clears, those fault states take effect. |

successfully power USB loads with additional bypass capacitance and/or large startup currents while protecting the upstream power source. No fault is reported if the switch brings up the load within the 20ms blanking period. See Table 2 for a summary of current-limit and fault behavior.

Applications Information

Input Power Supply and Capacitance

Connect both IN inputs together externally. IN powers the internal control circuitry and charge pump for the switch, allowing a decreased R_{ON} . Bypass IN to GND with a $1\mu F$ ceramic capacitor. When driving inductive loads or operating from inductive sources, which may occur when the device is powered by long leads or PC traces, larger input bypass capacitance is required to prevent voltage spikes from exceeding the absolute maximum ratings during short-circuit events.

Output Capacitor

Bypass OUT to GND with a $4.7\mu F$ ceramic capacitor for local decoupling. Additional bulk capacitance (up to $470\mu F$) reduces output-voltage transients under dynamic load conditions. Using output capacitors greater than $470\mu F$ might assert \overline{FAULT} if the current limit cannot

charge the output capacitor within the 20ms fault-blanking period. In addition to bulk capacitance, small-value ($0.1\mu F$ or greater) ceramic capacitors improve the output's resilience to electrostatic discharge (ESD).

Driving Inductive Loads

A wide variety of devices (mice, keyboards, cameras, and printers) typically connect to the USB port with cables, which might add an inductive component to the load. This inductance causes the output voltage at the USB port to oscillate during a load step. The MAX1562/MAX1562H/MAX1563 drive inductive loads, but avoid exceeding the device's absolute maximum ratings. The load inductance is usually relatively small, and the MAX1562/MAX1562H/MAX1563s' input includes a substantial bulk capacitance from an upstream regulator, as well as local bypass capacitors, limiting overshoot. If severe ringing occurs because of large-load inductance, clamp the MAX1562/MAX1562H/MAX1563 outputs below +6V and above -0.3V.

Turn-On and Turn-Off Behavior

When turned on, the MAX1562/MAX1562H/MAX1563 output ramps up over 2.5ms to eliminate load transients on the upstream power source. When turned off, the output

Programmable 4A USB Current-Limited Switches with Autoreset and Fault Blanking

ramps down for 800µs. Under fault conditions, the output of the switches turns off rapidly to provide maximum safety for the upstream power source and downstream devices. Internal blocks shut down to minimize supply current when the switch is off.

Layout and Thermal Dissipation

Keep all traces as short as possible to reduce the effect of undesirable parasitic inductance and optimize the switch response time to output short-circuit conditions. Place the input and output capacitors no more than 5mm from the device leads. Connect IN and OUT to the power bus with short traces. Wide power bus planes at IN and OUT provide superior heat dissipation.

Calculate the power dissipation for a normal loaded condition as follows:

$$P = (I_{OUT})^2 \times R_{ON}$$

At a 3A operating current and the maximum on-resistance of the switch (50mΩ), the power dissipation is:

$$P = (3A)^2 \times 0.05\Omega = 450mW$$

The worst-case power dissipation occurs when the output current is just below the current-limit threshold (set to 3A in this example) with an output voltage greater than +1V. In this case, the power dissipated in the switch is the voltage drop across the switch multiplied by the current limit:

$$P = I_{LIM} \times (V_{IN} - V_{OUT})$$

For a +5V input and +1V output, the maximum power dissipation is:

$$P = 3A \times (5V - 1V) = 12W$$

Because the package power dissipation is 471mW for

MAX1563 Functional Diagram

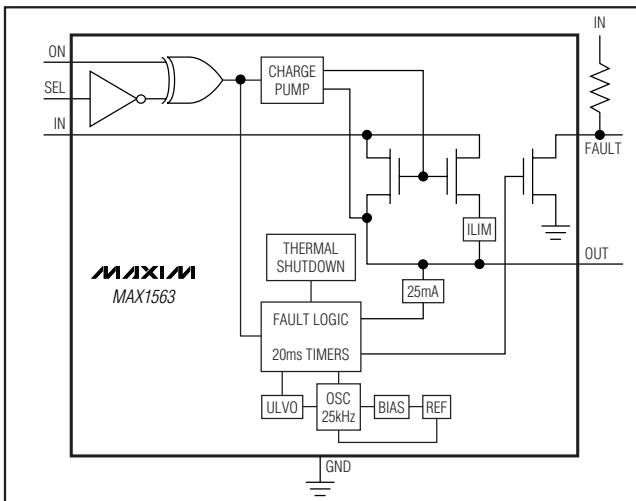

the MAX1562/MAX1562H and 1.35W for the MAX1563, the devices' die temperature exceeds the +160°C thermal-shutdown threshold, and the switch output shuts down until the junction temperature cools by 15°C. The duty cycle and period are strong functions of the ambient temperature and the PC board layout.

If the output current exceeds the current-limit threshold, or the output voltage is pulled below the short-circuit detect threshold, the MAX1562/MAX1562H/MAX1563 enter a fault state for 20ms, after which autoreset mode is enabled and 25mA is sourced by the output. For a +5V input, OUT short-circuited to GND, and autoreset mode active, the power dissipation is as follows:

$$P = 0.025A \times 5V = 0.125W$$

Typical Application Circuit

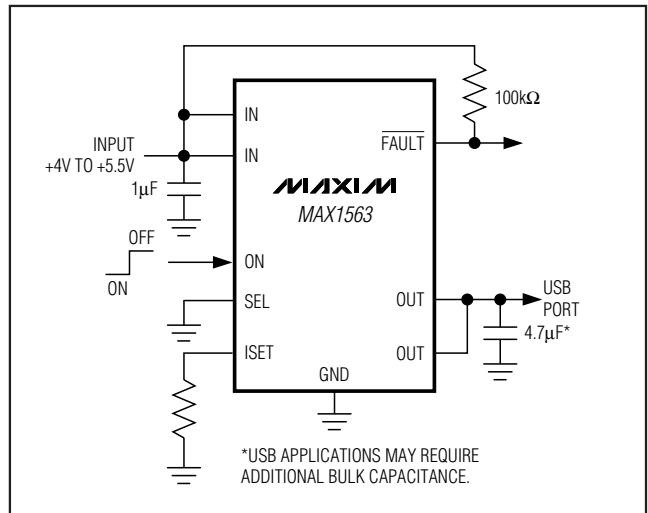

Pin Configurations

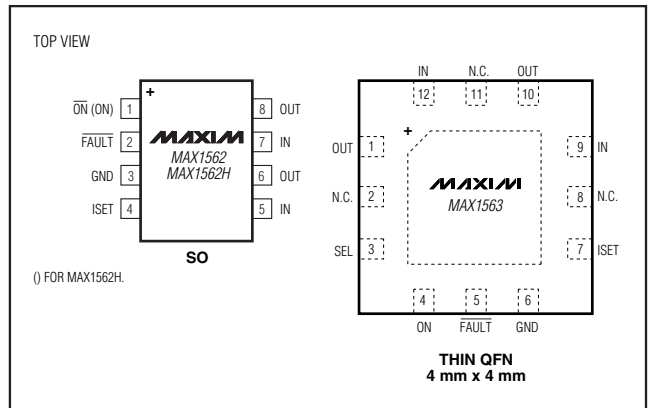

Programmable 4A USB Current-Limited Switches with Autoreset and Fault Blanking

Chip Information

TRANSISTOR COUNT: 1833

PROCESS: BiCMOS

Package Information

For the latest package outline information and land patterns, go to www.maxim-ic.com/packages. Note that a "+", "#", or "-" in the package code indicates RoHS status only. Package drawings may show a different suffix character, but the drawing pertains to the package regardless of RoHS status.

| PACKAGE TYPE | PACKAGE CODE | DOCUMENT NO. |
|--------------|--------------|-------------------------|
| 8 SO | S8-2 | 21-0041 |
| 12 TQFN-EP | T1244-4 | 21-0139 |

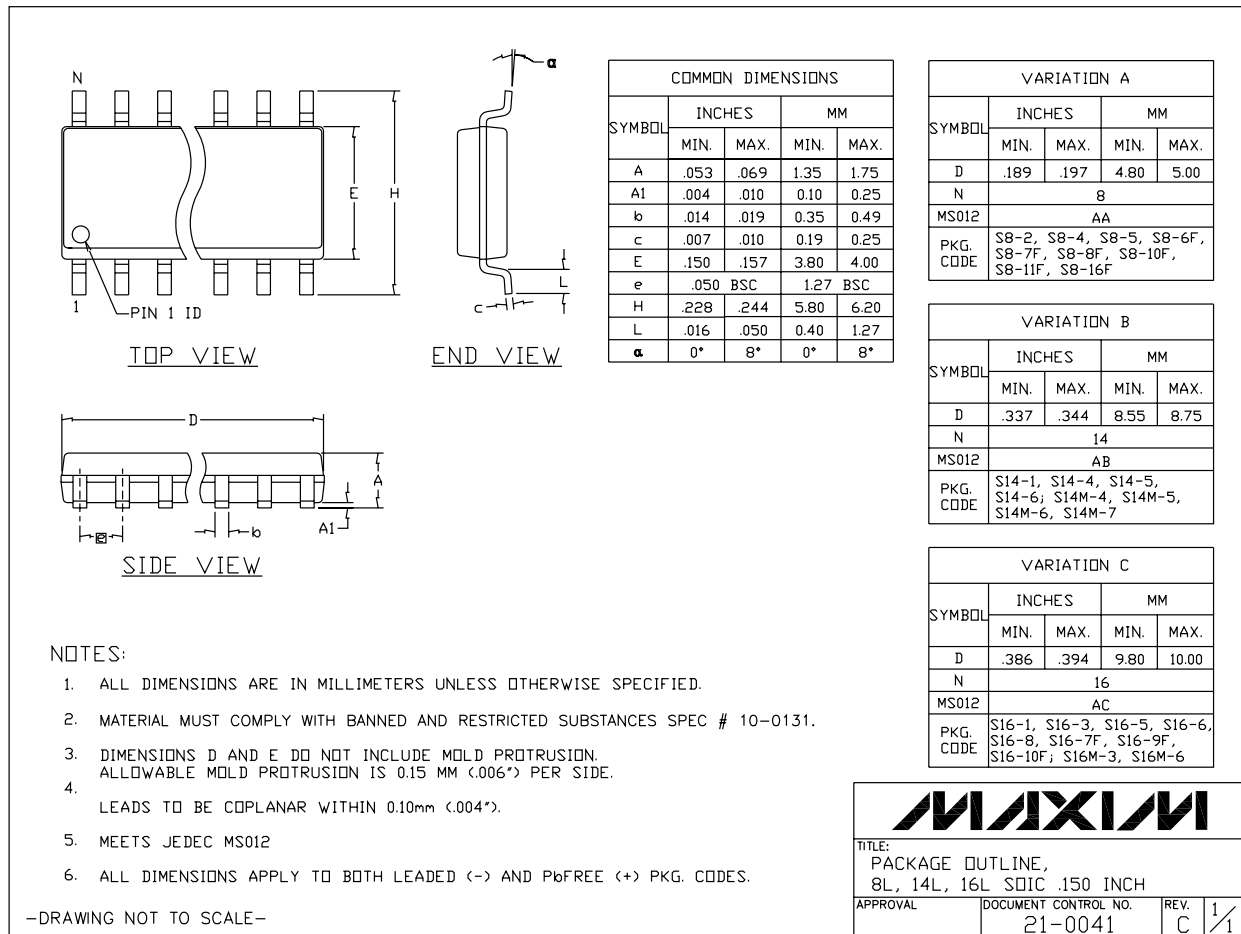

MAX1562/MAX1562H/MAX1563

Programmable 4A USB Current-Limited Switches with Autoreset and Fault Blanking

Package Information (continued)

For the latest package outline information and land patterns, go to www.maxim-ic.com/packages. Note that a "+", "#", or "-" in the package code indicates RoHS status only. Package drawings may show a different suffix character, but the drawing pertains to the package regardless of RoHS status.

MAX1562/MAX1562H/MAX1563

| COMMON DIMENSIONS | | | | | | | | | | | | | | | |
|-------------------|-----------|------|------|-----------|------|------|-----------|------|------|-----------|------|------|-----------|------|------|
| PKG | 12L 4x4 | | | 16L 4x4 | | | 20L 4x4 | | | 24L 4x4 | | | 28L 4x4 | | |
| REF. | MIN. | NDM. | MAX. | MIN. | NDM. | MAX. | MIN. | NDM. | MAX. | MIN. | NDM. | MAX. | MIN. | NDM. | MAX. |
| A | 0.70 | 0.75 | 0.80 | 0.70 | 0.75 | 0.80 | 0.70 | 0.75 | 0.80 | 0.70 | 0.75 | 0.80 | 0.70 | 0.75 | 0.80 |
| A1 | 0.0 | 0.02 | 0.05 | 0.0 | 0.02 | 0.05 | 0.0 | 0.02 | 0.05 | 0.0 | 0.02 | 0.05 | 0.0 | 0.02 | 0.05 |
| A2 | 0.20 REF | | | 0.20 REF | | | 0.20 REF | | | 0.20 REF | | | 0.20 REF | | |
| b | 0.25 | 0.30 | 0.35 | 0.25 | 0.30 | 0.35 | 0.20 | 0.25 | 0.30 | 0.18 | 0.23 | 0.30 | 0.15 | 0.20 | 0.25 |
| D | 3.90 | 4.00 | 4.10 | 3.90 | 4.00 | 4.10 | 3.90 | 4.00 | 4.10 | 3.90 | 4.00 | 4.10 | 3.90 | 4.00 | 4.10 |
| E | 3.90 | 4.00 | 4.10 | 3.90 | 4.00 | 4.10 | 3.90 | 4.00 | 4.10 | 3.90 | 4.00 | 4.10 | 3.90 | 4.00 | 4.10 |
| e | 0.80 BSC. | | | 0.65 BSC. | | | 0.50 BSC. | | | 0.50 BSC. | | | 0.40 BSC. | | |
| k | 0.25 | - | - | 0.25 | - | - | 0.25 | - | - | 0.25 | - | - | 0.25 | - | - |
| L | 0.45 | 0.55 | 0.65 | 0.45 | 0.55 | 0.65 | 0.45 | 0.55 | 0.65 | 0.30 | 0.40 | 0.50 | 0.30 | 0.40 | 0.50 |
| N | 12 | | | 16 | | | 20 | | | 24 | | | 28 | | |
| ND | 3 | | | 4 | | | 5 | | | 6 | | | 7 | | |
| NE | 3 | | | 4 | | | 5 | | | 6 | | | 7 | | |
| JeDEC Var. | VGGB | | | VGGC | | | VGGD-1 | | | VGGD-2 | | | VGGE | | |

| EXPOSED PAD VARIATIONS | | | | | | |
|------------------------|------|------|------|------|------|------|
| PKG. CODES | D2 | | | E2 | | |
| | MIN. | NDM. | MAX. | MIN. | NDM. | MAX. |
| T1244-3 | 1.95 | 2.10 | 2.25 | 1.95 | 2.10 | 2.25 |
| T1244-4 | 1.95 | 2.10 | 2.25 | 1.95 | 2.10 | 2.25 |
| T1644-3 | 1.95 | 2.10 | 2.25 | 1.95 | 2.10 | 2.25 |
| T1644-4 | 1.95 | 2.10 | 2.25 | 1.95 | 2.10 | 2.25 |
| T2044-2 | 1.95 | 2.10 | 2.25 | 1.95 | 2.10 | 2.25 |
| T2044-3 | 1.95 | 2.10 | 2.25 | 1.95 | 2.10 | 2.25 |
| T2444-2 | 1.95 | 2.10 | 2.25 | 1.95 | 2.10 | 2.25 |
| T2444-3 | 2.45 | 2.60 | 2.63 | 2.45 | 2.60 | 2.63 |
| T2444-4 | 2.45 | 2.60 | 2.63 | 2.45 | 2.60 | 2.63 |
| T2444N-4 | 2.45 | 2.60 | 2.63 | 2.45 | 2.60 | 2.63 |
| T2444M-1 | 2.45 | 2.60 | 2.63 | 2.45 | 2.60 | 2.63 |
| T2844-1 | 2.50 | 2.60 | 2.70 | 2.50 | 2.60 | 2.70 |

NOTES:

- DIMENSIONING & TOLERANCING CONFORM TO ASME Y14.5M-1994.
- ALL DIMENSIONS ARE IN MILLIMETERS. ANGLES ARE IN DEGREES.
- N IS THE TOTAL NUMBER OF TERMINALS.
- THE TERMINAL #1 IDENTIFIER AND TERMINAL NUMBERING CONVENTION SHALL CONFORM TO JEDEC 95-1 SPP-012. DETAILS OF TERMINAL #1 IDENTIFIER ARE OPTIONAL, BUT MUST BE LOCATED WITHIN THE ZONE INDICATED. THE TERMINAL #1 IDENTIFIER MAY BE EITHER A MOLD OR MARKED FEATURE.
- DIMENSION b APPLIES TO METALLIZED TERMINAL AND IS MEASURED BETWEEN 0.25mm AND 0.30mm FROM TERMINAL TIP.
- ND AND NE REFER TO THE NUMBER OF TERMINALS ON EACH D AND E SIDE RESPECTIVELY.
- DEPOPULATION IS POSSIBLE IN A SYMMETRICAL FASHION.
- COPLANARITY APPLIES TO THE EXPOSED HEAT SINK SLUG AS WELL AS THE TERMINALS.
- DRAWING CONFORMS TO JEDEC MO220, EXCEPT FOR T2444-3, T2444-4 AND T2844-1.
- MARKING IS FOR PACKAGE ORIENTATION REFERENCE ONLY.
- COPLANARITY SHALL NOT EXCEED 0.08mm.
- WARPAGE SHALL NOT EXCEED 0.10mm.
- LEAD CENTERLINES TO BE AT TRUE POSITION AS DEFINED BY BASIC DIMENSION 'e', ±0.05.
- NUMBER OF LEADS SHOWN ARE FOR REFERENCE ONLY.
- ALL DIMENSIONS ARE THE SAME FOR LEADED (-) & PbFREE (+) PACKAGE CODES.

-DRAWING NOT TO SCALE-

| | | |
|---|---------------------------------|------------|
|  | | |
| TITLE: PACKAGE OUTLINE 12,16,20,24,28L THIN QFN, 4x4x0.75mm | | |
| APPROVAL | DOCUMENT CONTROL NO. 21-0139 | REV. I 2/2 |

Programmable 4A USB Current-Limited Switches with Autoreset and Fault Blanking

Revision History

| REVISION NUMBER | REVISION DATE | DESCRIPTION | PAGES CHANGED |
|-----------------|---------------|---|---------------|
| 0 | 7/03 | Initial release | — |
| 1 | 7/09 | Changed package reference, package drawing, added lead-free designation, corrected <i>Pin Description</i> | 1, 2, 10, 11 |
| 2 | 2/10 | Removed UL Certification Pending bullet from the <i>Features</i> section | 1 |

Maxim cannot assume responsibility for use of any circuitry other than circuitry entirely embodied in a Maxim product. No circuit patent licenses are implied. Maxim reserves the right to change the circuitry and specifications without notice at any time.

14 **Maxim Integrated Products, 120 San Gabriel Drive, Sunnyvale, CA 94086 408-737-7600**

Looking for pricing, stock, or lifecycle information?

Click below to explore more details on WIN SOURCE:

- ⊖ [View MAX1562HESA+ on WIN SOURCE](#)
- ⊖ [Maxim Integrated Information](#)

Optimize Your Supply Chain with WIN SOURCE Solutions

- ✓ Global Sourcing Solution
- ✓ Obsolete Management
- ✓ Cost Control Management
- ✓ Shortage Management
- ✓ Alternative Solution
- ✓ Excess Inventory Management