



**THE DATASHEET OF
MABACT0062**



1:1 Transformer 3 - 200 MHz

Rev. V6

Features

- 1:1 Impedance Ratio
- Surface Mount Package
- Excellent Temperature Stability
- Can be used in both 50 Ω & 75 Ω Systems
- 260°C Reflow Compatible
- RoHS Compliant Version of ETC1-1T & MABACT0012
- Available on Tape & Reel

Schematic

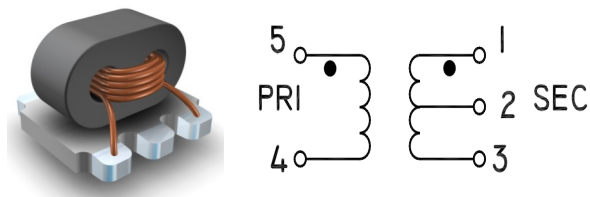

Pin Configuration

Pin #	Function
1	Secondary Dot
2	Secondary CT
3	Secondary
4	Primary
5	Primary Dot

Description

MABACT0062 is a 1:1 RF flux coupled transformer in a surface mount package.

Ideally suited for high volume CATV/Broadband applications.

Electrical Specifications: $T_A = 25^\circ\text{C}$, $Z_0 = 50 \Omega$ $P_{IN} = 0 \text{ dBm}$

Parameter	Frequency Test Conditions (MHz)	Units	Min.	Typ.	Max.
Insertion Loss	3 - 50	dB	—	0.2	0.5
	50 - 160			0.5	1.0
	160 - 200			0.8	1.2
Amplitude Balance (Nominal 0 dB)	3 - 50	dB	—	0.02	± 0.1
	50 - 200			0.06	± 0.5
Phase Balance (Nominal 180°)	3 - 50	°	—	0.2	± 1.5
	50 - 200			0.5	± 5.0
Input Return Loss	3 - 200	dB	10	20	—
	5 - 100		15	25	

Electrical Specifications: $T_A = 25^\circ\text{C}$, $Z_0 = 75 \Omega$ $P_{IN} = 0 \text{ dBm}$

Parameter	Frequency Test Conditions (MHz)	Units	Min.	Typ.	Max.
Insertion Loss	3 - 5	dB	—	0.5	1.0
	5 - 65			0.4	0.6
	65 - 200			0.6	1.0
Amplitude Balance (Nominal 0 dB)	3 - 65	dB	—	0.02	± 0.2
	65 - 200			0.04	± 0.3
Phase Balance (Nominal 180°)	3 - 65	°	—	0.4	± 2.0
	65 - 200			1.2	± 5.0
Input Return Loss	3 - 5	dB	18	24	—
	5 - 65		21	29	
	65 - 100		19	25	
	100 - 200		14	20	

1

MACOM Technology Solutions Inc. (MACOM) and its affiliates reserve the right to make changes to the product(s) or information contained herein without notice. Visit www.macom.com for additional data sheets and product information.

For further information and support please visit:
<https://www.macom.com/support>

DS-MABACT0062

Ordering information

Part #	Description
MABACT0062	2000 piece reel
MABA-008115-CT62TB	Customer Test Board

Reference Application Note **M513** for reel size information.

Recommended Maximum Ratings

Parameter	Value
Input Power	250 mW
DC Current	200 mA
Operating Temperature	-40°C to +85°C
Storage Temperature	-55°C to +125°C

Typical Performance Curves: $T_A = 25^\circ\text{C}$, $Z_0 = 50 \Omega$, $P_{IN} = 0 \text{ dBm}$

Insertion Loss

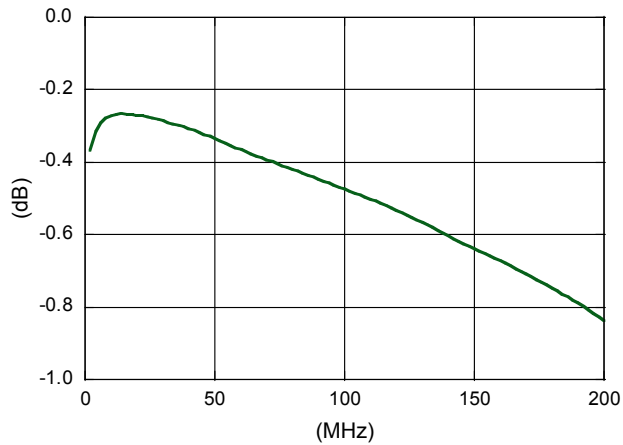

Input Return Loss

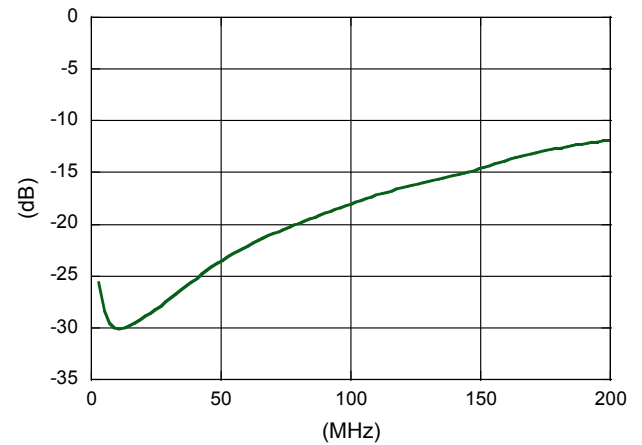

Amplitude Balance

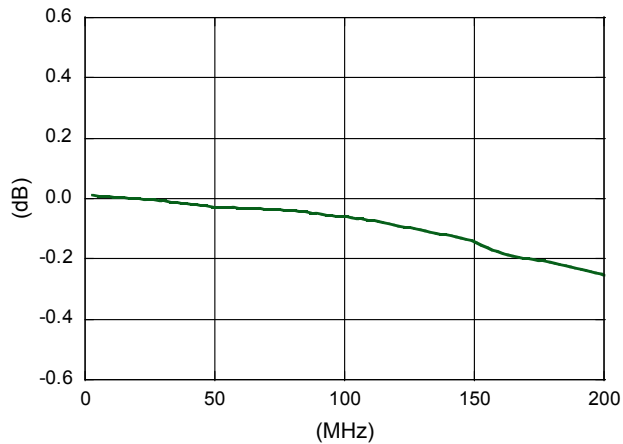

Phase Balance

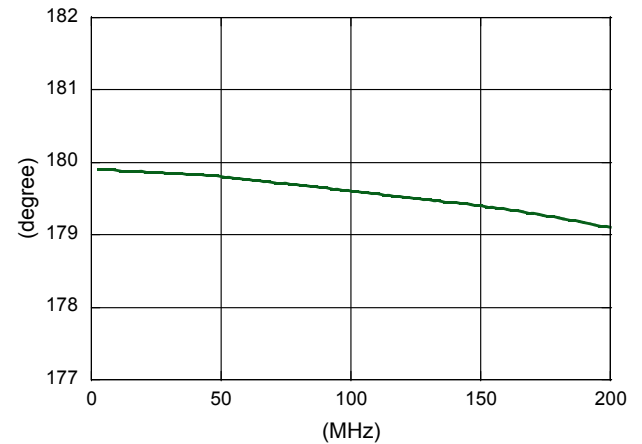

Outline Drawing

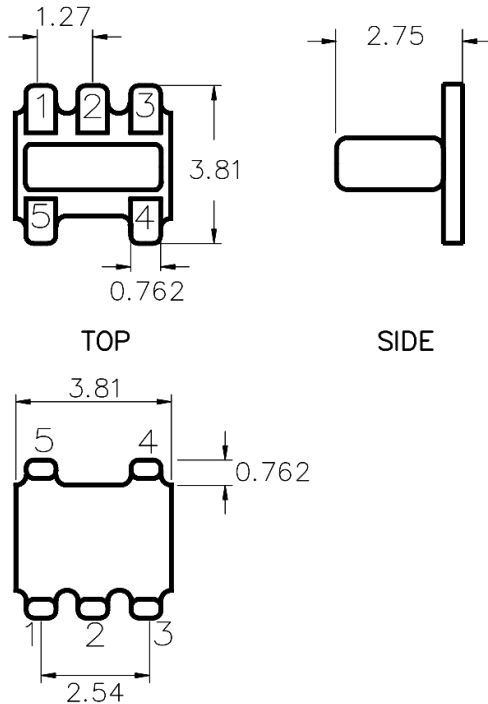

1. Dimensions in mm.
2. Tolerance: ± 0.2 mm unless otherwise noted.
3. Model number and lot code are printed on the reel.

Recommended Footprint

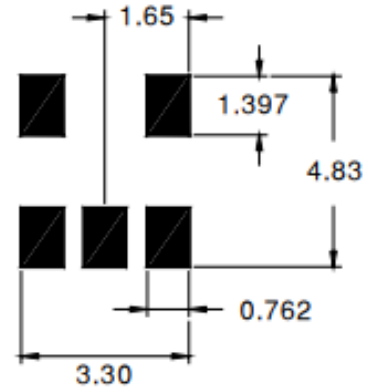

Tape & Reel Information

Parameter	Units	Value
Qty per reel	-	2000
Reel Size	mm	330
Tape Width	mm	12.00
Pitch	mm	8.00
Ao	mm	4.00
Bo	mm	4.00
Ko	mm	2.90
Orientation	-	F5
Reference Application Note ANI-019 for orientation		

MACOM Technology Solutions Inc. All rights reserved.

Information in this document is provided in connection with MACOM Technology Solutions Inc ("MACOM") products. These materials are provided by MACOM as a service to its customers and may be used for informational purposes only. Except as provided in MACOM's Terms and Conditions of Sale for such products or in any separate agreement related to this document, MACOM assumes no liability whatsoever. MACOM assumes no responsibility for errors or omissions in these materials. MACOM may make changes to specifications and product descriptions at any time, without notice. MACOM makes no commitment to update the information and shall have no responsibility whatsoever for conflicts or incompatibilities arising from future changes to its specifications and product descriptions. No license, express or implied, by estoppel or otherwise, to any intellectual property rights is granted by this document.

THESE MATERIALS ARE PROVIDED "AS IS" WITHOUT WARRANTY OF ANY KIND, EITHER EXPRESS OR IMPLIED, RELATING TO SALE AND/OR USE OF MACOM PRODUCTS INCLUDING LIABILITY OR WARRANTIES RELATING TO FITNESS FOR A PARTICULAR PURPOSE, CONSEQUENTIAL OR INCIDENTAL DAMAGES, MERCHANTABILITY, OR INFRINGEMENT OF ANY PATENT, COPYRIGHT OR OTHER INTELLECTUAL PROPERTY RIGHT. MACOM FURTHER DOES NOT WARRANT THE ACCURACY OR COMPLETENESS OF THE INFORMATION, TEXT, GRAPHICS OR OTHER ITEMS CONTAINED WITHIN THESE MATERIALS. MACOM SHALL NOT BE LIABLE FOR ANY SPECIAL, INDIRECT, INCIDENTAL, OR CONSEQUENTIAL DAMAGES, INCLUDING WITHOUT LIMITATION, LOST REVENUES OR LOST PROFITS, WHICH MAY RESULT FROM THE USE OF THESE MATERIALS.

MACOM products are not intended for use in medical, lifesaving or life sustaining applications. MACOM customers using or selling MACOM products for use in such applications do so at their own risk and agree to fully indemnify MACOM for any damages resulting from such improper use or sale.

Looking for pricing, stock, or lifecycle information?

Click below to explore more details on WIN SOURCE:

- ⊖ [View MABACT0062 on WIN SOURCE](#)
- ⊖ [M/A-Com Technology Solutions Information](#)

Optimize Your Supply Chain with WIN SOURCE Solutions

- ✓ Global Sourcing Solution
- ✓ Obsolete Management
- ✓ Cost Control Management
- ✓ Shortage Management
- ✓ Alternative Solution
- ✓ Excess Inventory Management