



**THE DATASHEET OF  
MAAMSS0060TR**



### Features

- 75  $\Omega$  Input / Output Match
- CTB: -75 dBc
- Noise Figure: 1.8 dB
- Gain: 17 dB, 20 dB
- Lead Free SOT-89 Package
- Halogen-Free “Green” Mold Compound
- RoHS\* Compliant and 260°C Reflow Compatible

### Description

M/A-COM's MAAMSS0060 CATV amplifier is a GaAs MMIC which exhibits low distortion in a lead free miniature surface mount plastic package. The MAAMSS0060 employs a monolithic single stage design featuring a convenient 75  $\Omega$  input/output impedance that minimizes the number of external components required.

The MAAMSS0060 provides low noise and high linearity. It is ideally suited for set top boxes, home gateways, FTTX, Drop Amplifiers, and other broadband internet based applications.

The MAAMSS0060 is fabricated using M/A-COM's PHEMT process to realize low noise and low distortion. The process features full passivation for robust performance and reliability.

### Functional Schematic

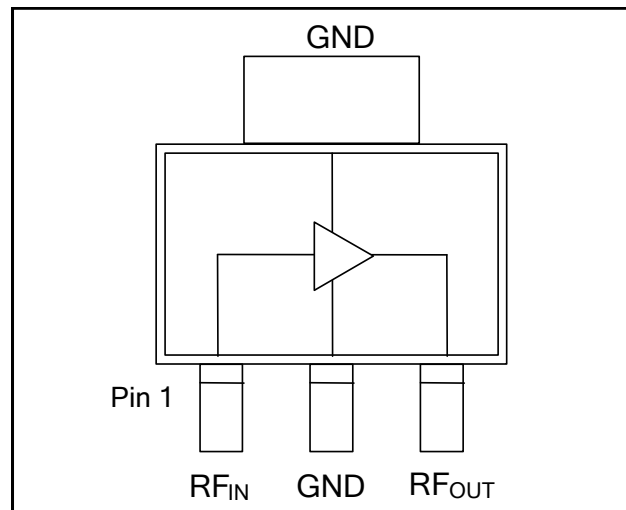

### Pin Configuration

Pin No.	Pin Name	Description
1	RF <sub>IN</sub>	RF Input
2	GND	Ground
3	RF <sub>OUT</sub>	RF Output / Drain Supply

### Ordering Information <sup>1,2</sup>

Part Number	Package
MAAMSS0060	Bulk Packaging
MAAMSS0060TR	1000 piece reel
MAAMSS0060TR-3000	3000 piece reel
MAAM-000060-001SMB <sup>2</sup>	17 dB Gain Configuration
MAAM-000060-002SMB <sup>2</sup>	20 dB Gain Configuration

1. Reference Application Note M513 for reel size information.
2. All sample boards include 5 loose parts.

### Absolute Maximum Ratings <sup>3,4,5</sup>

Parameter	Absolute Maximum
RF Input Power	6 dBm
Voltage	10.0 volts
Operating Temperature	-40°C to +85°C
Junction Temperature <sup>6</sup>	+150°C
Storage Temperature	-65°C to +150°C

3. Exceeding any one or combination of these limits may cause permanent damage to this device.
4. M/A-COM does not recommend sustained operation near these survivability limits.
5. These operating conditions will ensure MTTF > 1 x 10<sup>6</sup> hours.
6. Junction Temperature ( $T_J$ ) =  $T_C + \Theta_{jc} * (V * I)$   
 Typical thermal resistance ( $\Theta_{jc}$ ) = 58° C/W.
  - a) For  $T_C = 25^\circ\text{C}$ ,  
 $T_J = 81^\circ\text{C} @ 8 \text{ V}, 120 \text{ mA}$
  - b) For  $T_C = 85^\circ\text{C}$ ,  
 $T_J = 136^\circ\text{C} @ 8 \text{ V}, 110 \text{ mA}$

\* Restrictions on Hazardous Substances, European Union Directive 2002/95/EC.

## 17 dB Gain Configuration

**Electrical Specifications:  $T_A = 25^\circ\text{C}$ , Freq: 50 - 1000 MHz,  $V_{DD} = 8$  Volts,  $Z_0 = 75 \Omega$**

Parameter	Test Conditions	Units	Min.	Typ.	Max.
Gain		dB	15.8	17	17.8
Gain Flatness		dB	—	0.5	1.0
Noise Figure		dB	—	1.8	3.5
Input Return Loss		dB	—	20	—
Output Return Loss		dB	—	20	—
Output IP3	6 MHz Spacing, -10 dBm output per tone	dBm	—	37	—
Composite Triple Beat, CTB	132 channels, +30 dBmV / channel at the output.	dBc	—	-75	—
Composite Second Order, CSO	132 channels, +30 dBmV / channel at the output.	dBc	—	-60	—
P1dB		dBm	—	23	—
$I_{DD}$	8 Volts	mA	—	120	140

## 20 dB Gain Configuration

**Typical Performance:  $T_A = 25^\circ\text{C}$ , Freq: 50 - 1000 MHz,  $V_{DD} = 8$  Volts,  $Z_0 = 75 \Omega$**

Parameter	Test Conditions	Units	Min.	Typ.	Max.
Gain		dB	—	20	—
Gain Flatness		dB	—	1	—
Noise Figure		dB	—	1.6	—
Input Return Loss		dB	—	12	—
Output Return Loss		dB	—	12	—
Output IP3	6 MHz Spacing, -10 dBm output per tone	dBm	—	35	—
Composite Triple Beat, CTB	132 channels, +33 dBmV / channel at the output.	dBc	—	-66	—
Composite Second Order, CSO	132 channels, +33 dBmV / channel at the output.	dBc	—	-55	—
P1dB		dBm	—	21	—
$I_{DD}$	8 Volts	mA	—	120	—

## 17 & 20 dB Gain Configuration Schematic Including Off-Chip Components

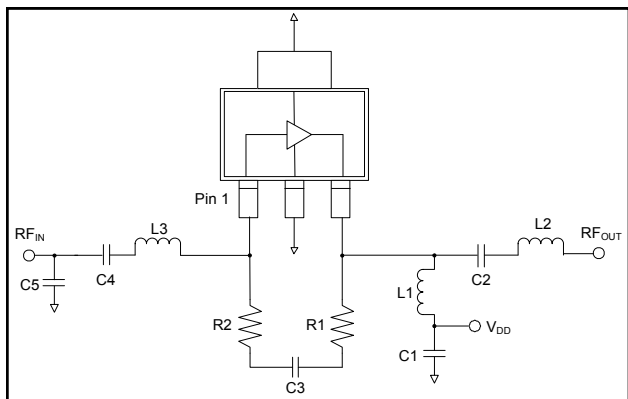

## 17 dB Gain Configuration Off-Chip Component Values

Component	Value	Package
C1,C3,C4	0.01 $\mu$ F	0402
C2	470 pF	0402
C5	0.7 pF	0402
L1 <sup>7</sup>	1 $\mu$ H	1210
L2	4.7 nH	0402
L3	8.2 nH	0402
R1	560 $\Omega$	0402
R2	91 $\Omega$	0402

7. L1 supplied from EPCOS, part number B82422A1102K100

## 17 & 20 dB Gain Configuration Recommended Board Layout

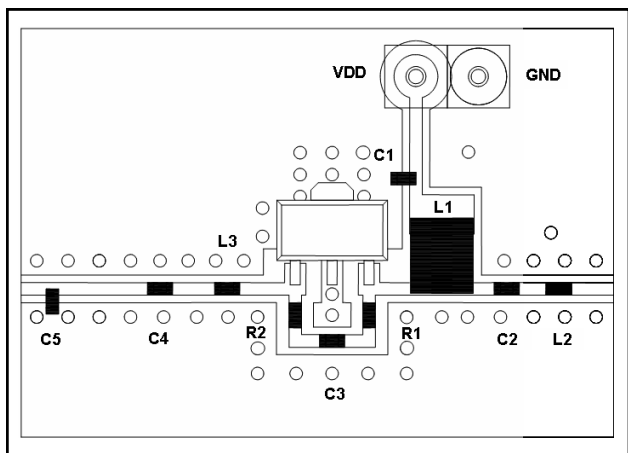

## 20 dB Gain Configuration Off-Chip Component Values

Component	Value	Package
C1,C2,C3,C4	0.01 $\mu$ F	0402
C5	0.75 pF	0402
L1 <sup>8</sup>	1.5 $\mu$ H	1210
L2	10 nH	0402
L3	12 nH	0402
R1	750 $\Omega$	0402
R2	360 $\Omega$	0402

8. L1 supplied from EPCOS, part number B82422A1152K100

## Typical Performance Curves: 17dB Gain Configuration

**Gain to 1 GHz over Temperature**

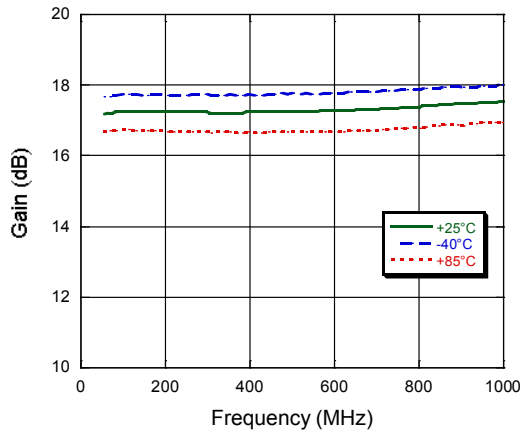

**Gain to 3 GHz over Temperature**

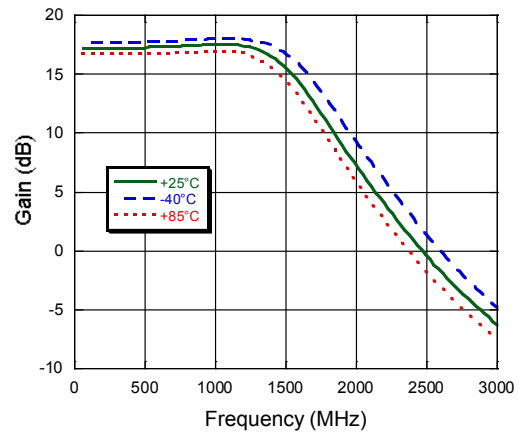

**Input Return Loss over Temperature**

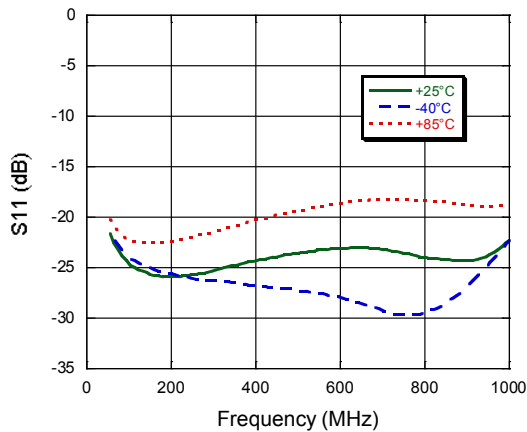

**Output Return Loss over Temperature**

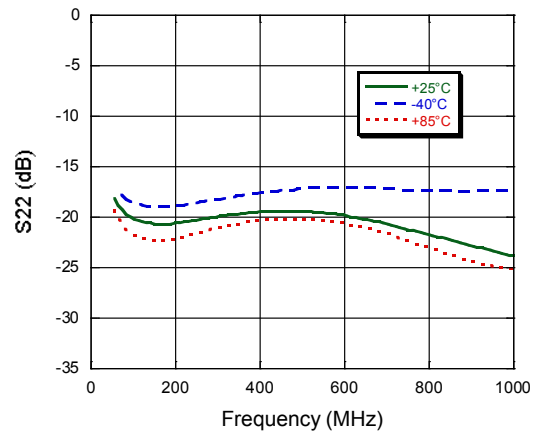

**Noise Figure**

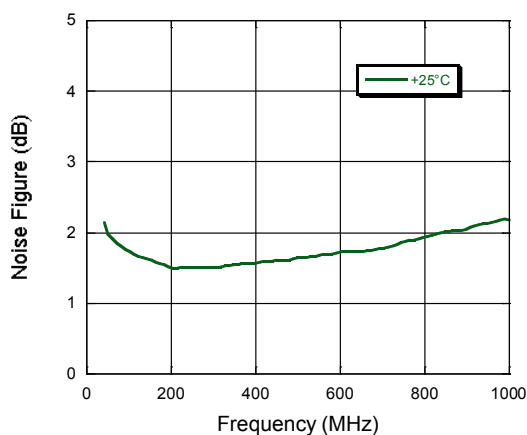

## Typical Performance Curves: 20 dB Gain Configuration

**Gain to 1 GHz**

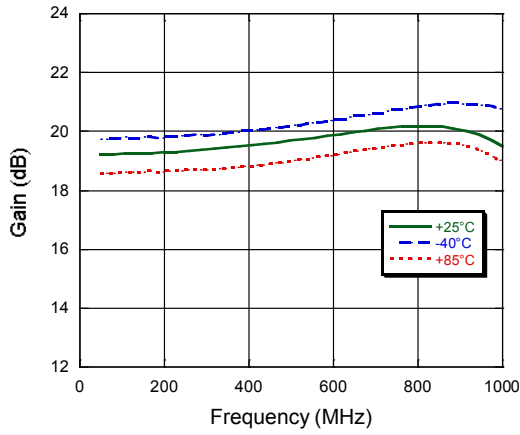

**Gain to 3 GHz**

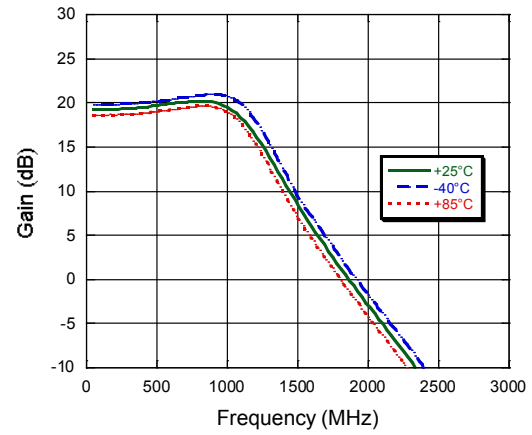

**Input Return Loss**

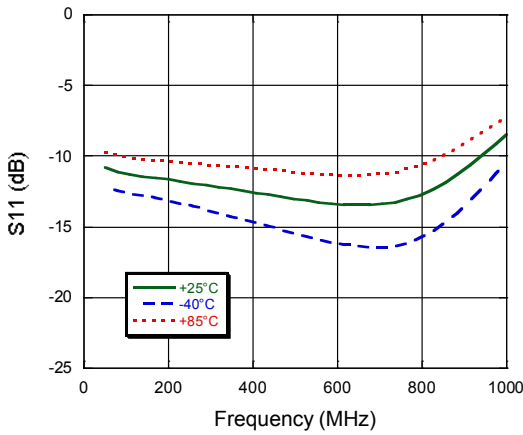

**Output Return Loss**

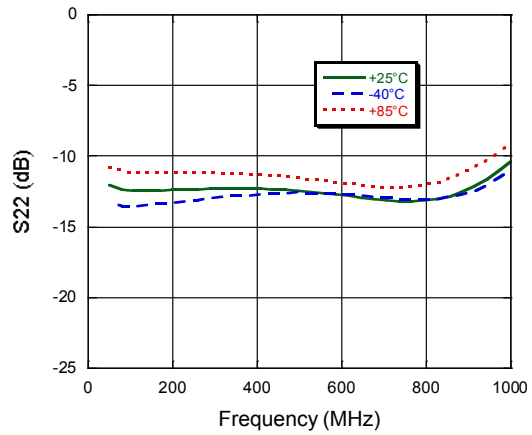

**Noise Figure**

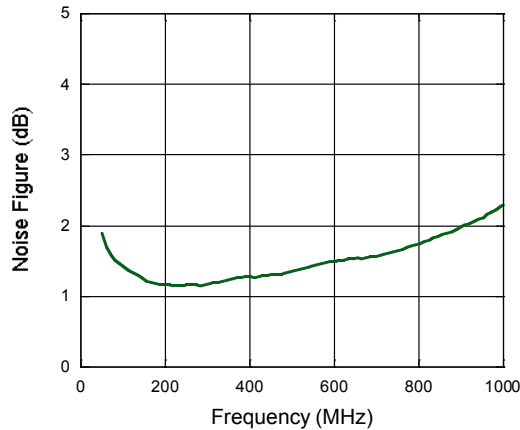

## Lead-Free SOT-89 Plastic Package<sup>†</sup>

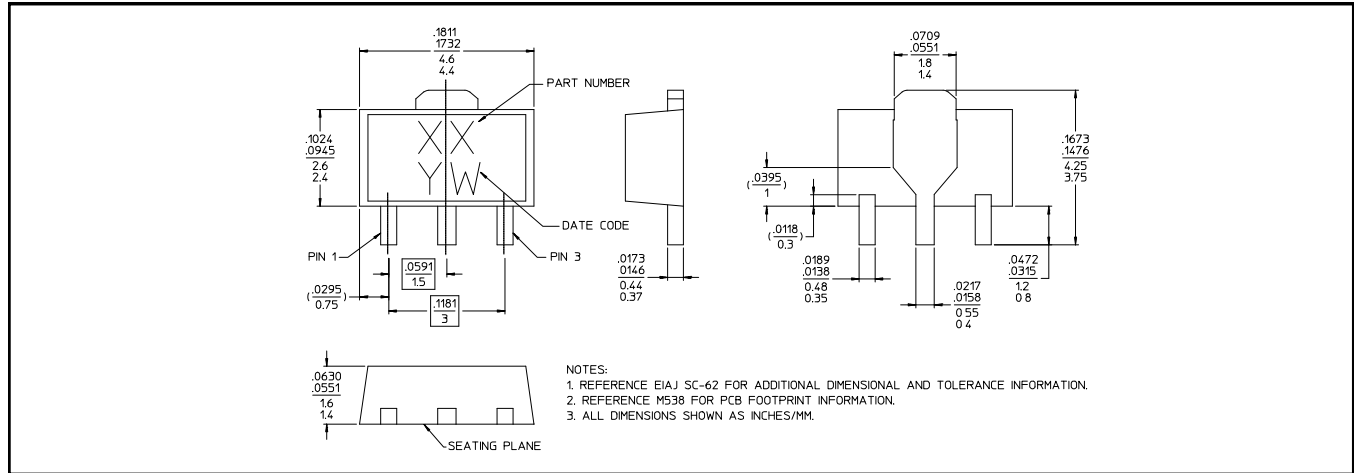

<sup>†</sup> Reference Application Note M538 for lead-free solder reflow recommendations.  
 Meets JEDEC moisture sensitivity level 1 requirements.  
 Plating is 100% matte tin over copper.

## Handling Procedures

Please observe the following precautions to avoid damage:

## Static Sensitivity

Gallium Arsenide Integrated Circuits are sensitive to electrostatic discharge (ESD) and can be damaged by static electricity. Proper ESD control techniques should be used when handling these devices.

M/A-COM Technology Solutions Inc. All rights reserved.

Information in this document is provided in connection with M/A-COM Technology Solutions Inc ("MACOM") products. These materials are provided by MACOM as a service to its customers and may be used for informational purposes only. Except as provided in MACOM's Terms and Conditions of Sale for such products or in any separate agreement related to this document, MACOM assumes no liability whatsoever. MACOM assumes no responsibility for errors or omissions in these materials. MACOM may make changes to specifications and product descriptions at any time, without notice. MACOM makes no commitment to update the information and shall have no responsibility whatsoever for conflicts or incompatibilities arising from future changes to its specifications and product descriptions. No license, express or implied, by estoppels or otherwise, to any intellectual property rights is granted by this document.

THESE MATERIALS ARE PROVIDED "AS IS" WITHOUT WARRANTY OF ANY KIND, EITHER EXPRESS OR IMPLIED, RELATING TO SALE AND/OR USE OF MACOM PRODUCTS INCLUDING LIABILITY OR WARRANTIES RELATING TO FITNESS FOR A PARTICULAR PURPOSE, CONSEQUENTIAL OR INCIDENTAL DAMAGES, MERCHANTABILITY, OR INFRINGEMENT OF ANY PATENT, COPYRIGHT OR OTHER INTELLECTUAL PROPERTY RIGHT. MACOM FURTHER DOES NOT WARRANT THE ACCURACY OR COMPLETENESS OF THE INFORMATION, TEXT, GRAPHICS OR OTHER ITEMS CONTAINED WITHIN THESE MATERIALS. MACOM SHALL NOT BE LIABLE FOR ANY SPECIAL, INDIRECT, INCIDENTAL, OR CONSEQUENTIAL DAMAGES, INCLUDING WITHOUT LIMITATION, LOST REVENUES OR LOST PROFITS, WHICH MAY RESULT FROM THE USE OF THESE MATERIALS.

MACOM products are not intended for use in medical, lifesaving or life sustaining applications. MACOM customers using or selling MACOM products for use in such applications do so at their own risk and agree to fully indemnify MACOM for any damages resulting from such improper use or sale.

## Looking for pricing, stock, or lifecycle information?

Click below to explore more details on WIN SOURCE:

- ⊖ [View MAAMSS0060TR on WIN SOURCE](#)
- ⊖ [M/A-Com Technology Solutions Information](#)

## Optimize Your Supply Chain with WIN SOURCE Solutions

- ✓ Global Sourcing Solution
- ✓ Obsolete Management
- ✓ Cost Control Management
- ✓ Shortage Management
- ✓ Alternative Solution
- ✓ Excess Inventory Management