

MA4X726 (MA726)

Silicon epitaxial planar type

For super high speed switching

For small current rectification

■ Features

- Two isolated elements are contained in one package, allowing high-density mounting
- Two MA3X721 (MA721) is contained in one package (two diodes in a different direction)
- Forward current (Average) $I_{F(AV)} = 200$ mA rectification is possible

■ Absolute Maximum Ratings $T_a = 25^\circ\text{C}$

Parameter	Symbol	Rating	Unit
Reverse voltage	V_R	30	V
Repetitive peak reverse voltage	V_{RRM}	30	V
Peak forward current	Single	I_{FM}	300
	Series *1		225
Forward current (Average)	Single	$I_{F(AV)}$	200
	Series *1		150
Non-repetitive peak forward surge current *2	Single	I_{FSM}	1.00
	Series *1		0.75
Junction temperature	T_j	150	$^\circ\text{C}$
Storage temperature	T_{stg}	-55 to +150	$^\circ\text{C}$

Note) *1: Value of each diode in series diodes used.

*2: The peak-to-peak value in one cycle of 50 Hz sine wave (non-repetitive)

■ Electrical Characteristics $T_a = 25^\circ\text{C} \pm 3^\circ\text{C}$

Parameter	Symbol	Conditions	Min	Typ	Max	Unit
Forward voltage	V_F	$I_F = 200$ mA			0.55	V
Reverse current	I_R	$V_R = 30$ V			50	μA
Terminal capacitance	C_t	$V_R = 0$ V, $f = 1$ MHz		30		pF
Reverse recovery time *	t_{rr}	$I_F = I_R = 100$ mA $I_{tr} = 10$ mA, $R_L = 100 \Omega$		3.0		ns

Note) 1. Measuring methods are based on JAPANESE INDUSTRIAL STANDARD JIS C 7031 measuring methods for diodes.

2. This product is sensitive to electric shock (static electricity, etc.). Due attention must be paid on the charge of a human body and the leakage of current from the operating equipment.

3. Absolute frequency of input and output is 1 GHz.

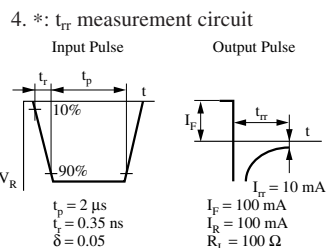
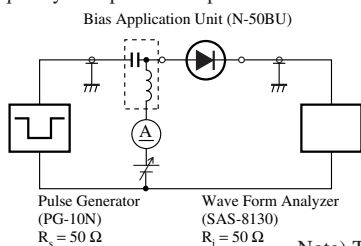

Note) The part number in the parenthesis shows conventional part number.

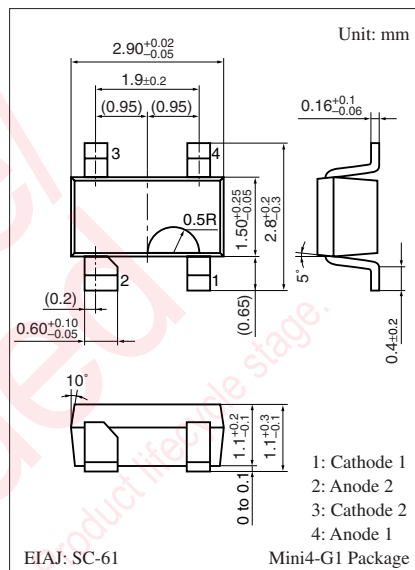

Marking Symbol: M10

Internal Connection

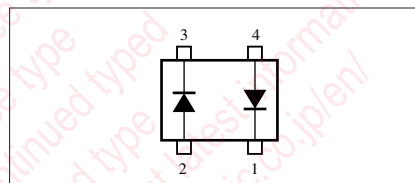

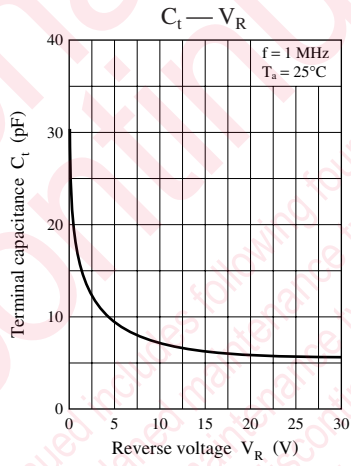
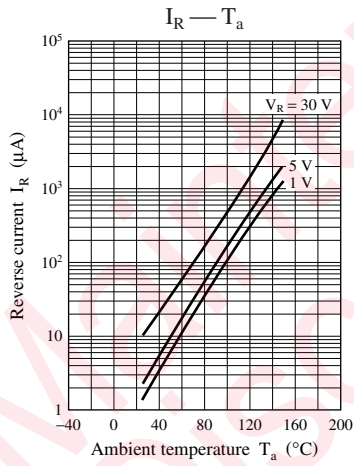
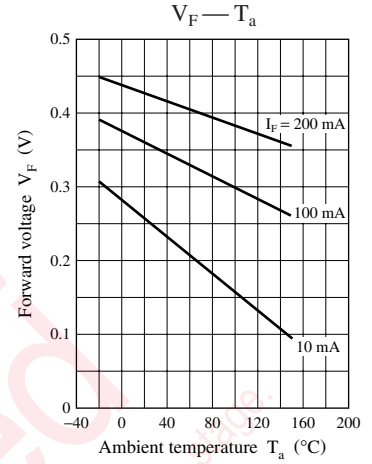
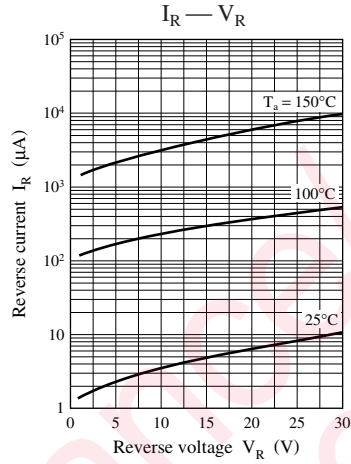
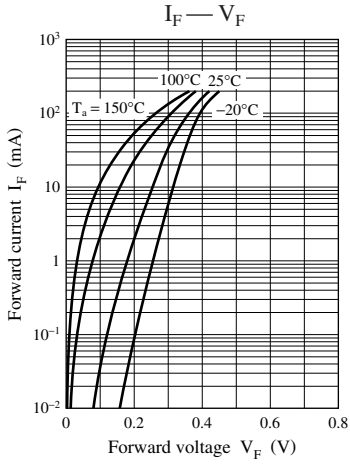

utions in using the technical information and scribed in this book

s book is to be exported or provided to non-residents, the laws and
rd to security export control, must be observed.

ly to show the main characteristics and application circuit examples
l property right or other right owned by our company or any other
any as to the infringement upon any such right owned by any other
rmation described in this book.

standard applications or general electronic equipment (such as office
and household appliances).

ng applications:

biles, traffic control equipment, combustion equipment, life support
reliability are required, or if the failure or malfunction of the prod-

ck are subject to change without notice for modification and/or im-
use of the products, therefore, ask for the most up-to-date Product
atisfy your requirements.

bsolute maximum rating and the guaranteed operating conditions
(.). Especially, please be careful not to exceed the range of absolute
er-off and mode-switching. Otherwise, we will not be liable for any

take into the consideration of incidence of break down and failure
n the systems such as redundant design, arresting the spread of fire
al injury, fire, social damages, for example, by using the products.

own and characteristics change due to external factors (ESD, EOS,
mounting or at customer's process. When using products for which
shelf life and the elapsed time since first opening the packages.

ly or partially, without the prior written permission of Matsushita

Looking for pricing, stock, or lifecycle information?

Click below to explore more details on WIN SOURCE:

 [View MA726-\(TX\) on WIN SOURCE](#)

 [Panasonic Information](#)

Optimize Your Supply Chain with WIN SOURCE Solutions

-  Global Sourcing Solution
-  Obsolete Management
-  Cost Control Management
-  Shortage Management
-  Alternative Solution
-  Excess Inventory Management