

MA3S132DG, MA3S132EG

Silicon epitaxial planar type

For switching circuits

■ Features

- Short reverse recovery time t_{rr}
- Small terminal capacitance C_t
- Two isolated elements contained in one package, allowing high-density mounting

■ Package

- Code
SSMini3-F3
- Pin Name
MA3S132DG MA3S132EG
1: Cathode 1 1: Anode 1
2: Cathode 2 2: Anode 2
3: Anode 3: Cathode

■ Absolute Maximum Ratings $T_a = 25^\circ\text{C}$

Parameter	Symbol	Rating	Unit
Reverse voltage	V_R	80	V
Maximum peak reverse voltage	V_{RM}	80	V
Forward current	Single	I_F	100
	Double		150
Peak forward current	Single	I_{FM}	225
	Double		340
Non-repetitive peak forward surge current *	Single	I_{FSM}	500
	Double		750
Junction temperature	T_j	150	$^\circ\text{C}$
Storage temperature	T_{stg}	-55 to +150	$^\circ\text{C}$

■ Marking Symbol

MA3S132DG: MO
MA3S132EG: MU

■ Internal Connection

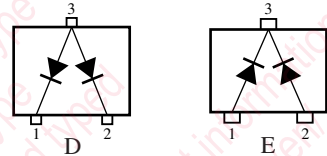

Note) *: $t = 1\text{ s}$

■ Electrical Characteristics $T_a = 25^\circ\text{C} \pm 3^\circ\text{C}$

Parameter	Symbol	Conditions	Min	Typ	Max	Unit
Forward voltage	V_F	$I_F = 100\text{ mA}$			1.2	V
Reverse voltage	V_R	$I_R = 100\ \mu\text{A}$	80			V
Reverse current	I_R	$V_R = 75\text{ V}$			100	nA
Terminal capacitance	MA3S132DG	$V_R = 0\text{ V}, f = 1\text{ MHz}$			15	pF
	MA3S132EG				2	
Reverse recovery time *	MA3S132DG	$I_F = 10\text{ mA}, V_R = 6\text{ V}$ $I_{rr} = 0.1 I_R, R_L = 100\ \Omega$			10	ns
	MA3S132EG				3	

Note) 1. Measuring methods are based on JAPANESE INDUSTRIAL STANDARD JIS C 7031 measuring methods for diodes.

2. Absolute frequency of input and output is 100 MHz.

3. *: t_{rr} measurement circuit

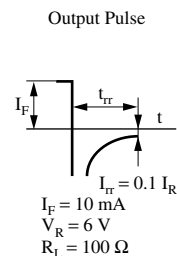
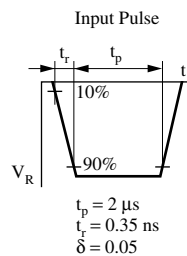
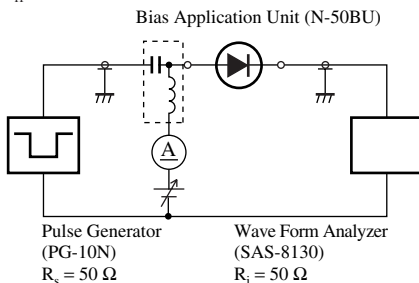

Characteristics charts of MA3S132DG

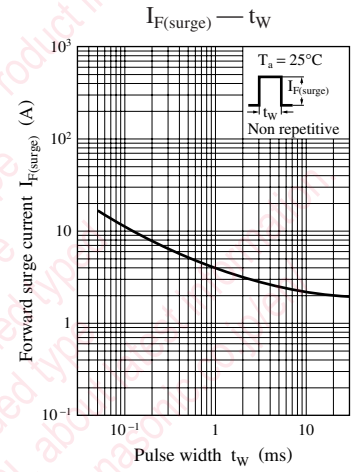
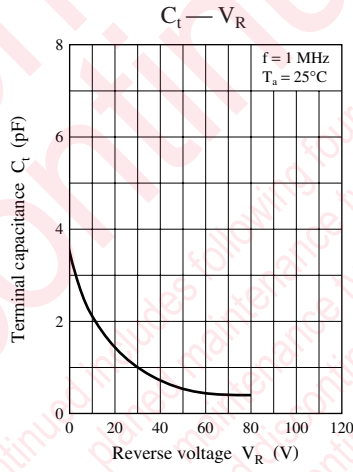
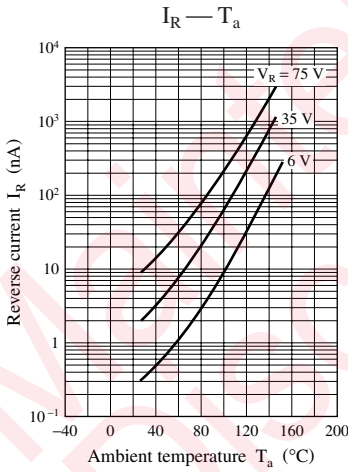
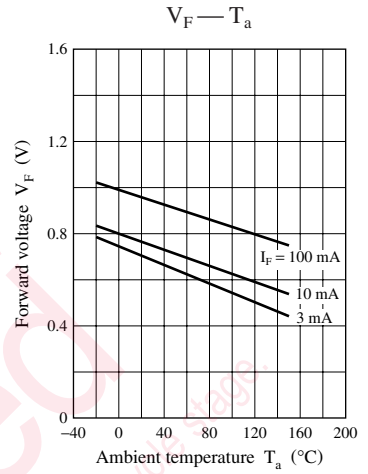
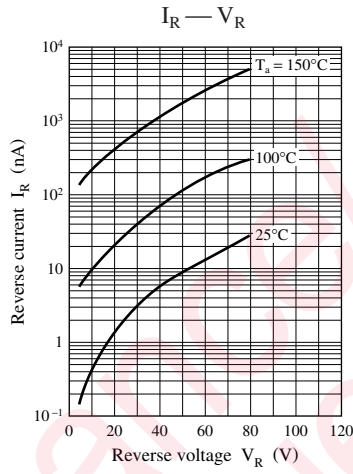
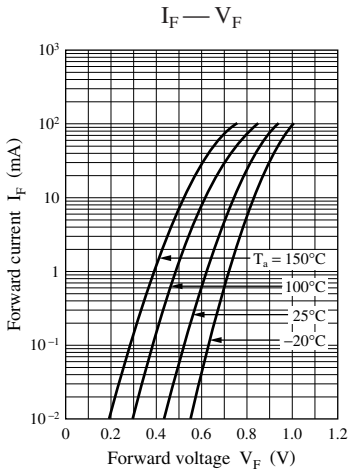

Characteristics charts of MA3S132EG

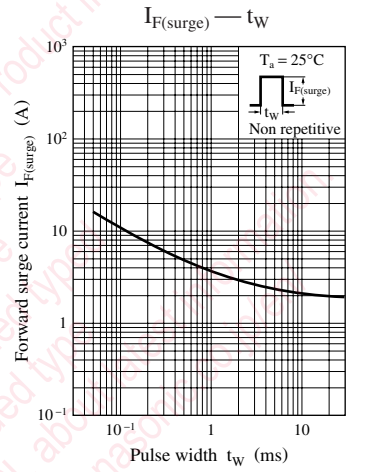
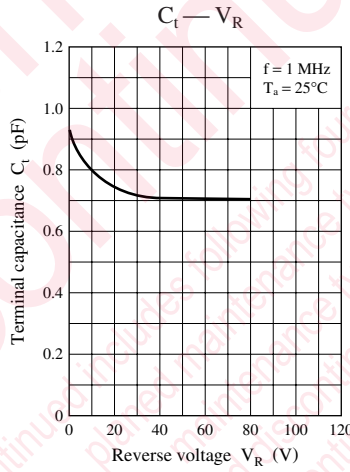
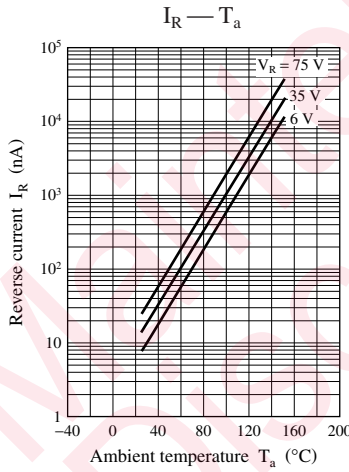
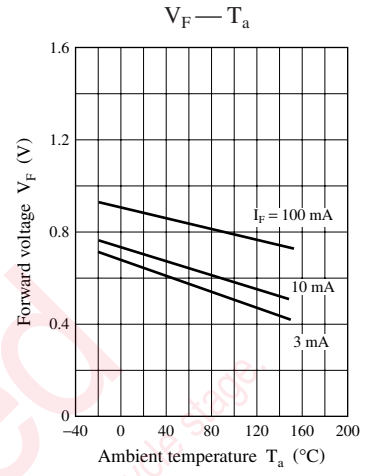
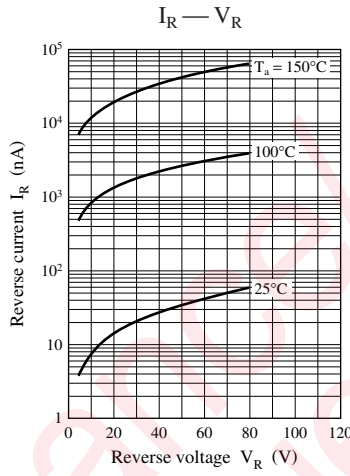
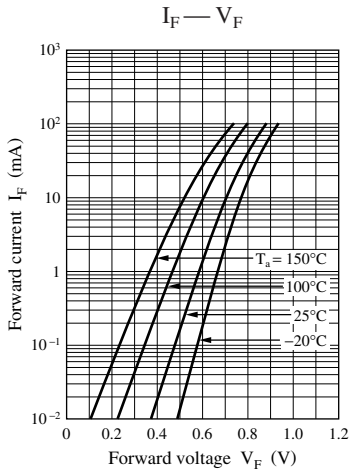

SSMini3-F3

Unit: mm

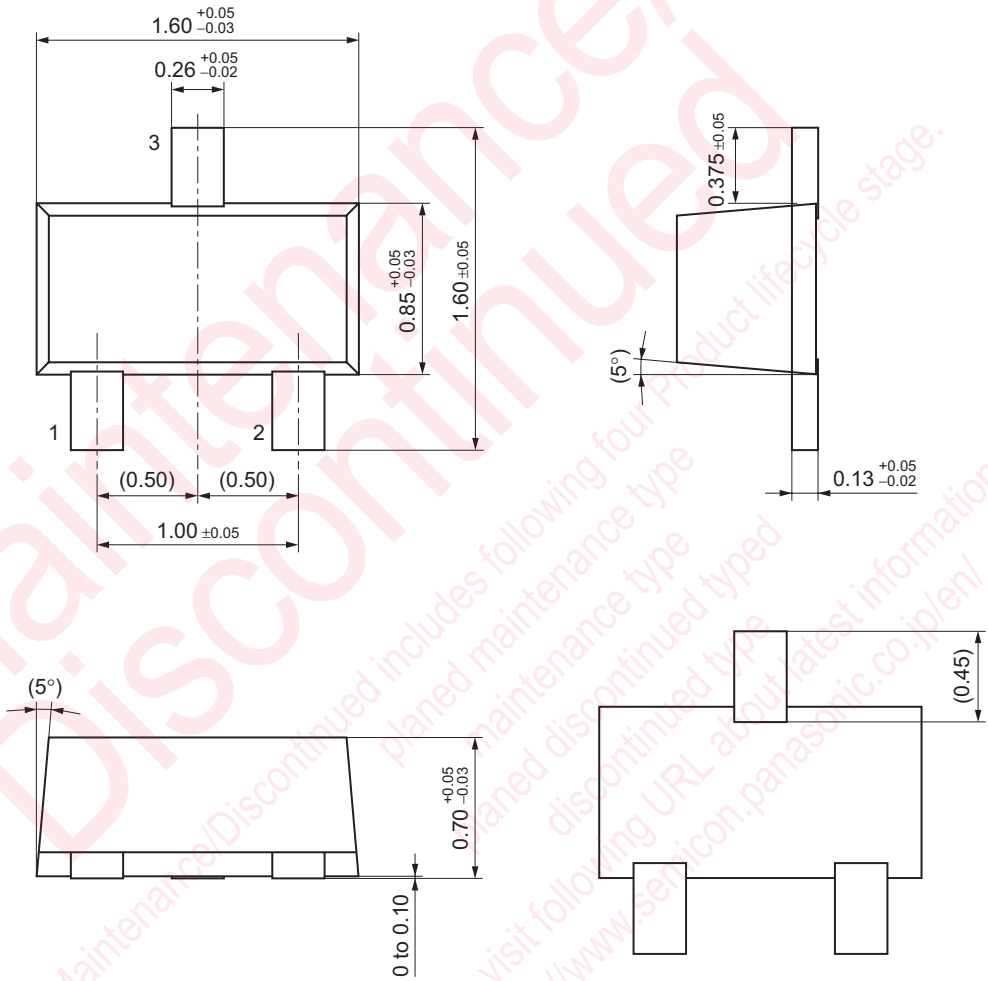

utions in using the technical information and scribed in this book

s book is to be exported or provided to non-residents, the laws and
rd to security export control, must be observed.

ly to show the main characteristics and application circuit examples
l property right or other right owned by our company or any other
any as to the infringement upon any such right owned by any other
rmation described in this book.

standard applications or general electronic equipment (such as office
and household appliances).

ng applications:

biles, traffic control equipment, combustion equipment, life support
reliability are required, or if the failure or malfunction of the prod-

ck are subject to change without notice for modification and/or im-
use of the products, therefore, ask for the most up-to-date Product
atisfy your requirements.

bsolute maximum rating and the guaranteed operating conditions
(.). Especially, please be careful not to exceed the range of absolute
er-off and mode-switching. Otherwise, we will not be liable for any

take into the consideration of incidence of break down and failure
n the systems such as redundant design, arresting the spread of fire
al injury, fire, social damages, for example, by using the products.

own and characteristics change due to external factors (ESD, EOS,
mounting or at customer's process. When using products for which
shelf life and the elapsed time since first opening the packages.

ly or partially, without the prior written permission of Matsushita







Looking for pricing, stock, or lifecycle information?

Click below to explore more details on WIN SOURCE:

 [View MA3S132DGL on WIN SOURCE](#)

 [Panasonic Information](#)

Optimize Your Supply Chain with WIN SOURCE Solutions

-  Global Sourcing Solution
-  Obsolete Management
-  Cost Control Management
-  Shortage Management
-  Alternative Solution
-  Excess Inventory Management