

MA3J143 (MA143), MA3J143A (MA143A)

Silicon epitaxial planar type

For switching circuits

■ Features

- Two isolated elements contained in one package, allowing high-density mounting
- Two diodes are connected in series in the package

■ Absolute Maximum Ratings $T_a = 25^\circ\text{C}$

Parameter	Symbol	Rating	Unit	
Reverse voltage	MA3J143	V_R	40	V
	MA3J143A		80	
Maximum peak reverse voltage	MA3J143	V_{RM}	40	V
	MA3J143A		80	
Forward current	Single	I_F	100	mA
	Series		65	
Peak forward current	Single	I_{FM}	200	mA
	Series		130	
Junction temperature	T_j	150	$^\circ\text{C}$	
Storage temperature	T_{stg}	-55 to +150	$^\circ\text{C}$	

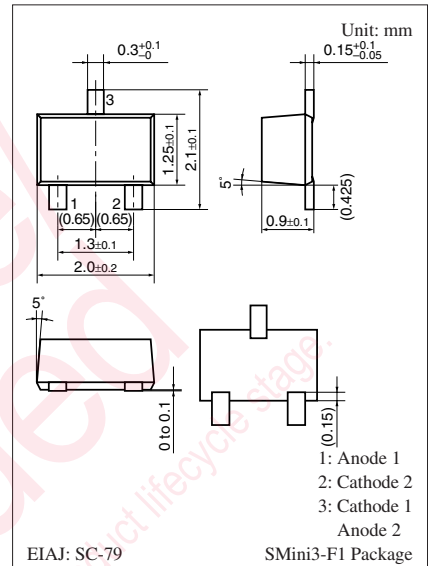

Marking Symbol:

- MA3J143: MC
- MA3J143A: MP

Internal Connection

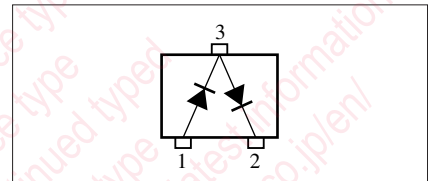

■ Electrical Characteristics $T_a = 25^\circ\text{C} \pm 3^\circ\text{C}$

Parameter	Symbol	Conditions	Min	Typ	Max	Unit
Forward voltage	V_F	$I_F = 100 \text{ mA}$			1.2	V
Reverse voltage	MA3J143	$I_R = 100 \mu\text{A}$	40			V
	MA3J143A		80			
Reverse current	MA3J143	$V_R = 40 \text{ V}$			100	nA
	MA3J143A	$V_R = 75 \text{ V}$			100	
Terminal capacitance	C_{t1}^{*1}	$V_R = 0 \text{ V}, f = 1 \text{ MHz}$			5.5	pF
	C_{t2}^{*2}				3.0	
Reverse recovery time *3	t_{rr1}^{*1}	$I_F = 10 \text{ mA}, V_R = 6 \text{ V}$		150		ns
	t_{rr2}^{*2}	$I_{rr} = 0.1 I_R, R_L = 100 \Omega$		9		

Note) 1. Measuring methods are based on JAPANESE INDUSTRIAL STANDARD JIS C 7031 measuring methods for diodes.

2. Absolute frequency of input and output is 100 MHz.

3. *1: Between pins 2 and 3

*2: Between pins 1 and 3

*3: t_{rr} measurement circuit

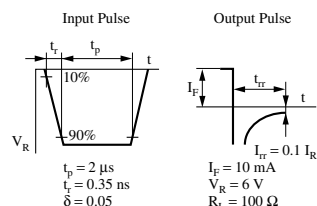
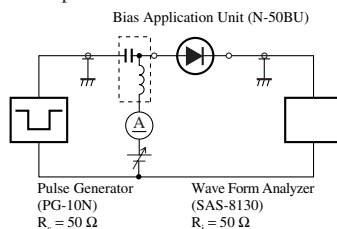

Note) The part numbers in the parenthesis show conventional part number.

Characteristics charts of MA3J143

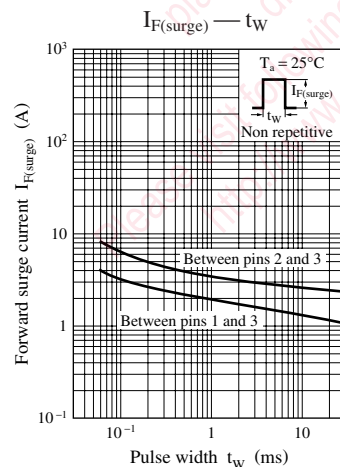
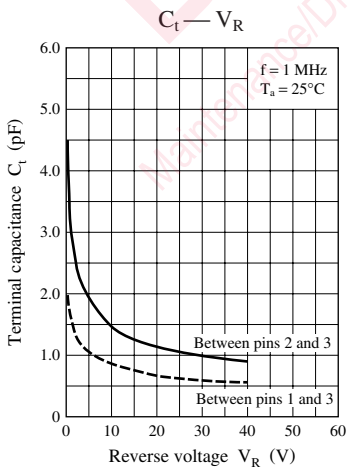
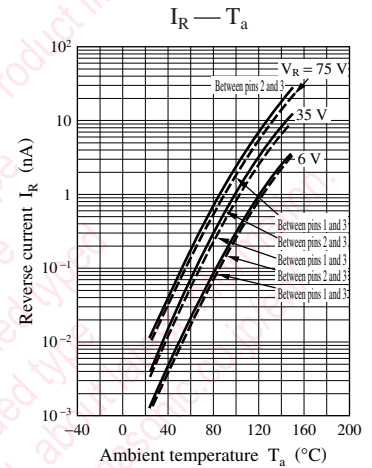
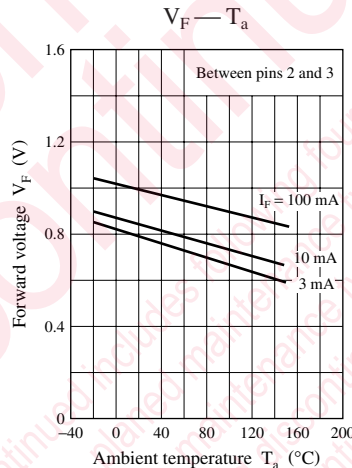
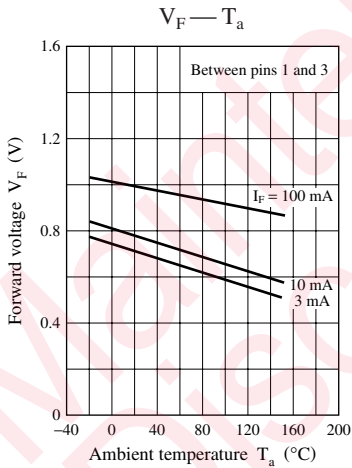
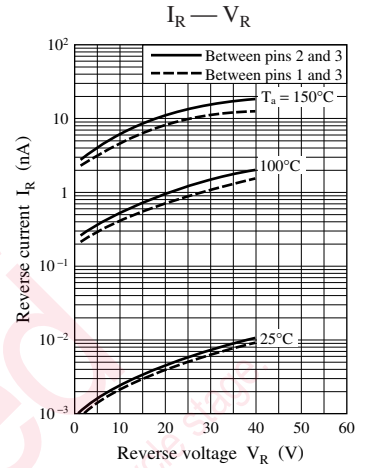
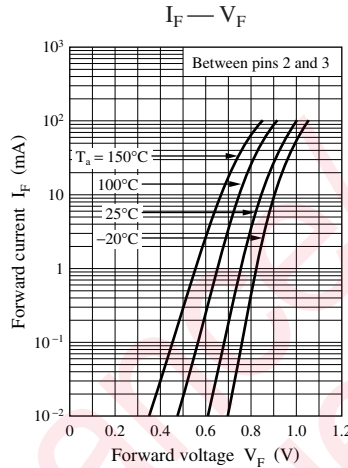
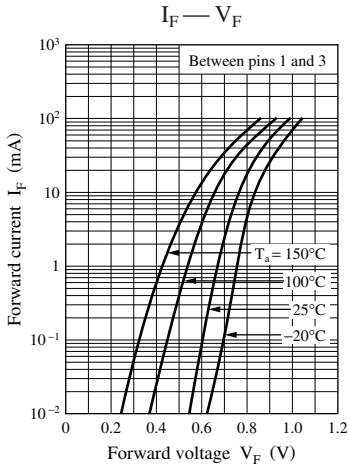

Characteristics charts of MA3J143A

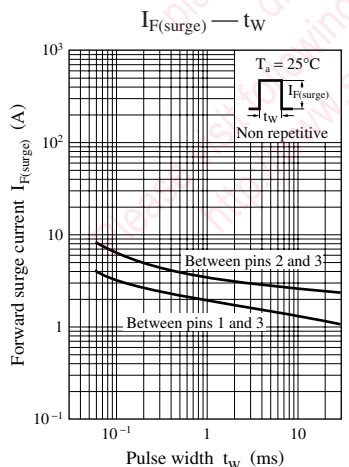
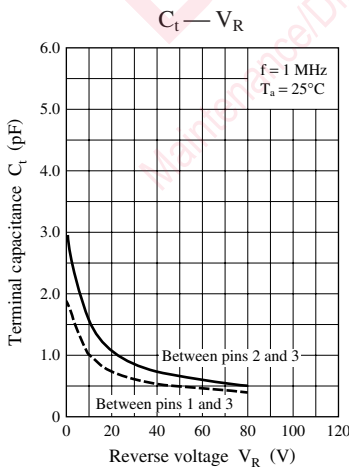
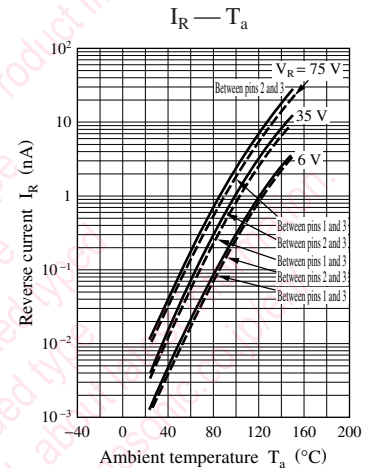
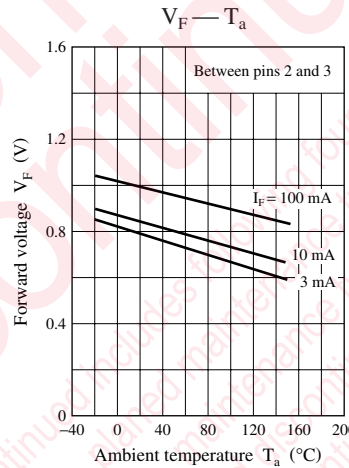
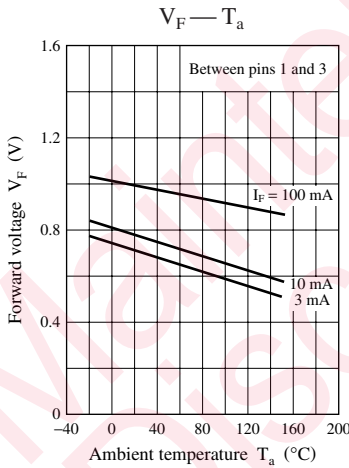
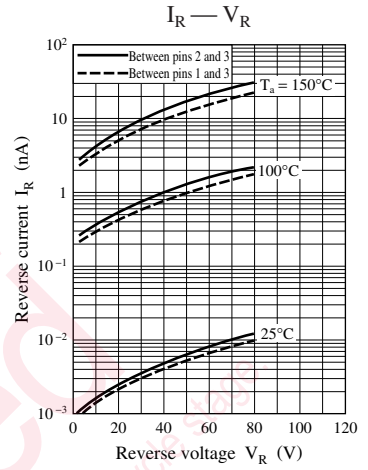
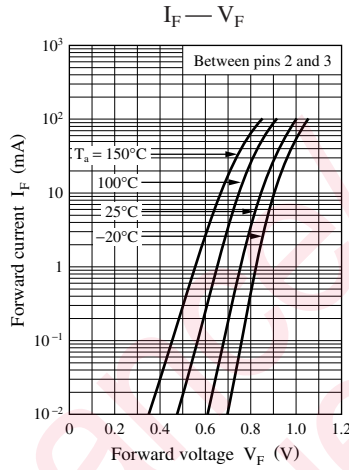
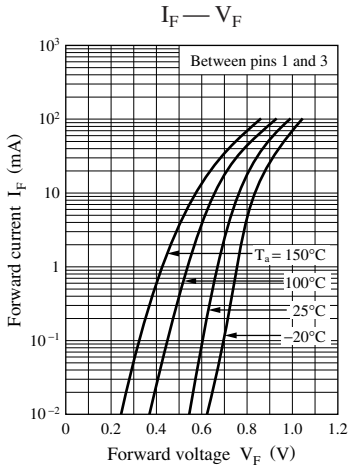

utions in using the technical information and scribed in this book

s book is to be exported or provided to non-residents, the laws and
rd to security export control, must be observed.

ly to show the main characteristics and application circuit examples
l property right or other right owned by our company or any other
any as to the infringement upon any such right owned by any other
rmation described in this book.

standard applications or general electronic equipment (such as office
and household appliances).

ng applications:

biles, traffic control equipment, combustion equipment, life support
reliability are required, or if the failure or malfunction of the prod-

ck are subject to change without notice for modification and/or im-
use of the products, therefore, ask for the most up-to-date Product
atisfy your requirements.

bsolute maximum rating and the guaranteed operating conditions
(.). Especially, please be careful not to exceed the range of absolute
er-off and mode-switching. Otherwise, we will not be liable for any

take into the consideration of incidence of break down and failure
n the systems such as redundant design, arresting the spread of fire
al injury, fire, social damages, for example, by using the products.

own and characteristics change due to external factors (ESD, EOS,
mounting or at customer's process. When using products for which
shelf life and the elapsed time since first opening the packages.

ly or partially, without the prior written permission of Matsushita

Looking for pricing, stock, or lifecycle information?

Click below to explore more details on WIN SOURCE:

 [View MA3J14300L on WIN SOURCE](#)

 [Panasonic Information](#)

Optimize Your Supply Chain with WIN SOURCE Solutions

-  Global Sourcing Solution
-  Obsolete Management
-  Cost Control Management
-  Shortage Management
-  Alternative Solution
-  Excess Inventory Management