

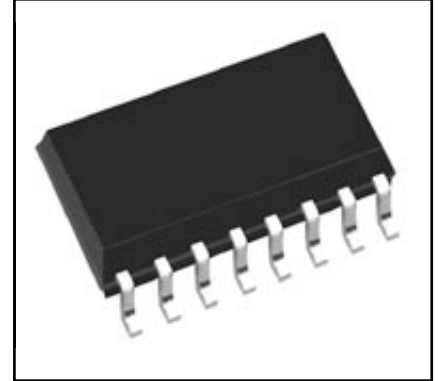

THE DATASHEET OF M81709FP

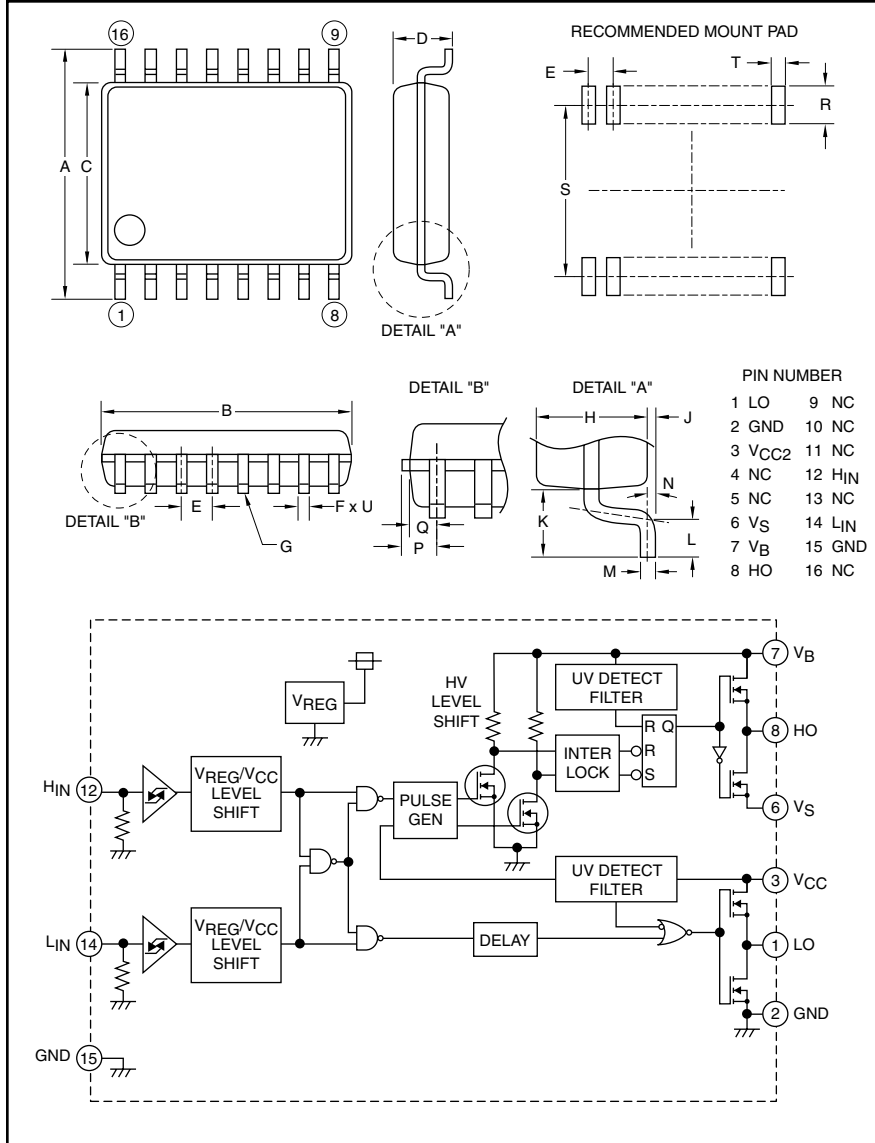

HVIC High Voltage Half-Bridge Driver 600 Volts/±2A



Description:
M81709FP is a high voltage Power MOSFET and IGBT module driver for half-bridge applications.

- Features:**
- Shoot Through Interlock
 - Output Current ±2A
 - Half-Bridge Driver
 - SOP-16 Package

- Applications:**
- HID Ballast
 - PDP
 - MOSFET Driver
 - IGBT Driver
 - Inverter Module Control

Ordering Information:
M81709FP is a ±2A, 600 Volt HVIC, High Voltage Half-Bridge Driver

Outline Drawing and Circuit Diagram

Dimensions	Inches	Millimeters
A	0.31±0.01	7.8±0.3
B	0.41±0.004	10.1±0.1
C	0.21±0.004	5.3±0.1
D	0.12	2.10
E	0.05	1.27
F	0.02±0.002	0.4±0.05
G	0.004	0.1
H	0.07	1.8
J	0.01±0.004	0.1±0.1
K	0.05	1.25

Dimensions	Inches	Millimeters
L	0.024±0.008	0.6±0.2
M	0.1±0.002	0.2±0.05
N	8°	8°
P	0.03	0.755
Q	0.023	0.605
R	0.05 Min.	1.27 Min.
S	0.30	7.62
T	0.029	0.76
U	0.098 Dia.	0.25 Dia.



Powerex, Inc., 200 E. Hillis Street, Youngwood, Pennsylvania 15697-1800 (724) 925-7272

M81709FP

HVIC, High Voltage Half-Bridge Driver

600 Volts/±2A

Absolute Maximum Ratings, $T_a = 25^\circ\text{C}$ unless otherwise specified

Characteristics	Symbol	M81709FP	Units
High Side Floating Supply Absolute Voltage	V_B	-0.5 ~ 624	Volts
High Side Floating Supply Offset Voltage	V_S	$V_B - 24 \sim V_B + 0.5$	Volts
High Side Floating Supply Voltage ($V_{BS} = V_B - V_S$)	V_{BS}	-0.5 ~ 24	Volts
High Side Output Voltage	V_{HO}	$V_S - 0.5 \sim V_B + 0.5$	Volts
Low Side Fixed Supply Voltage	V_{CC}	-0.5 ~ 24	Volts
Low Side Output Voltage	V_{LO}	-0.5 ~ $V_{CC} + 0.5$	Volts
Logic Input Voltage (H_{IN}, L_{IN})	V_{IN}	-0.5 ~ $V_{CC} + 0.5$	Volts
Allowable Offset Voltage Transient	dVs/dt	±50	V/ns
Package Power Dissipation ($T_a = 25^\circ\text{C}$, On Board)	P_d	0.9	Watts
Linear Derating Factor ($T_a > 25^\circ\text{C}$, On Board)	K_θ	9.0	mW/°C
Junction to Case Thermal Resistance	$R_{th(j-c)}$	50	°C/W
Junction Temperature	T_j	-20 ~ 125	°C
Operation Temperature	T_{opr}	-20 ~ 100	°C
Storage Temperature	T_{stg}	-40 ~ 125	°C

Recommended Operating Conditions

Characteristics	Symbol	Test Conditions	Min.	Typ.	Max.	Units
High Side Floating Supply Absolute Voltage	V_B		$V_S + 10$	—	$V_S + 20$	Volts
High Side Floating Supply Offset Voltage	V_S	$V_B > 10V$	-5	—	500	Volts
High Side Floating Supply Voltage	V_{BS}	$V_B = V_B - V_S$	10	—	20	Volts
High Side Output Voltage	V_{HO}		V_S	—	V_B	Volts
Low Side Fixed Supply Voltage	V_{CC}		10	—	20	Volts
Logic Supply Voltage	V_{LO}		0	—	V_{CC}	Volts
Logic Input Voltage	V_{IN}	H_{IN}, L_{IN}	0	—	V_{CC}	Volts

Electrical Characteristics

$T_a = 25^\circ\text{C}$, $V_{CC} = V_{BS} (= V_B - V_S) = 15V$ unless otherwise specified

Characteristics	Symbol	Test Conditions	Min.	Typ.	Max.	Units
Floating Supply Leakage Current	I_{FS}	$V_B = V_S = 600V$	—	—	1.0	µA
V_{BS} Standby Current	I_{BS}	$H_{IN} = L_{IN} = 0V$	—	0.2	0.5	mA
V_{CC} Standby Current	I_{CC}	$H_{IN} = L_{IN} = 0V$	0.2	0.5	1.0	mA
High Level Output Voltage	V_{OH}	$I_O = 0A, L_O, H_O$	13.8	14.4	—	Volts
Low Level Output Voltage	V_{OL}	$I_O = 0A, L_O, H_O$	—	—	0.1	Volts
High Level Input Threshold Voltage	V_{IH}	H_{IN}, L_{IN}	2.1	3.0	4.0	Volts
Low Level Input Threshold Voltage	V_{IL}	H_{IN}, L_{IN}	0.6	1.5	2.0	Volts
High Level Input Bias Current	I_{IH}	$V_{IN} = 5V$	—	25	75	µA
Low Level Input Bias Current	I_{IL}	$V_{IN} = 0V$	—	—	1.0	µA
V_{BS} Supply UV Reset Voltage	V_{BSuvr}		8.0	8.9	9.8	Volts
V_{BS} Supply UV Hysteresis Voltage	V_{BSuvh}		0.3	0.7	—	Volts
V_{BS} Supply UV Filter Time	t_{VBSuv}		—	7.5	—	µs
V_{CC} Supply UV Reset Voltage	V_{CCuvr}		8.0	8.9	9.8	Volts

M81709FP

HVIC, High Voltage Half-Bridge Driver

600 Volts/±2A

Electrical Characteristics

T_a = 25°C, V_{CC} = V_{BS} (= V_B - V_S) = 15V unless otherwise specified

Characteristics	Symbol	Test Conditions	Min.	Typ.	Max.	Units
V _{CC} Supply UV Hysteresis Voltage	V _{CCuvh}		0.3	0.7	—	Volts
V _{CC} Supply UV Filter Time	t _{VCCuv}		—	7.5	—	µs
Output High Level Short Circuit Pulsed Current	I _{OH}	V _O = 0V, V _{IN} = 5V, P _W < 10µs	—	2.5	—	A
Output Low Level Short Circuit Pulsed Current	I _{OL}	V _O = 15V, V _{IN} = 0V, P _W < 10µs	—	2.5	—	A
Output High Level ON Resistance	R _{OH}	I _O = -200mA, R _{OH} = (V _{OH} - V _O)/I _O	—	10	13	Ω
Output Low Level ON Resistance	R _{OL}	I _O = 200mA, R _{OL} = V _O /I _O	—	2.5	3.0	Ω
High Side Turn-On Propagation Delay	t _{dLH(HO)}	C _L = 1000pF between HO - V _S	100	135	170	ns
High Side Turn-Off Propagation Delay	t _{dHL(HO)}	C _L = 1000pF between HO - V _S	100	135	170	ns
High Side Turn-On Rise Time	t _{rH}	C _L = 1000pF between HO - V _S	—	20	35	ns
High Side Turn-Off Fall Time	t _{fH}	C _L = 1000pF between HO - V _S	—	15	25	ns
LowSide Turn-On Propagation Delay	t _{dLH(LO)}	C _L = 1000pF between LO - GND	100	135	170	ns
Low Side Turn-Off Propagation Delay	t _{dHL(LO)}	C _L = 1000pF between LO - GND	100	135	170	ns
Low Side Turn-On Rise Time	t _{rL}	C _L = 1000pF between LO - GND	—	20	35	ns
Low Side Turn-Off Fall Time	t _{fL}	C _L = 1000pF between LO - GND	—	15	25	ns
Delay Matching, High Side and Low Side Turn-On	Δt _{dLH}	t _{dLH(HO)} - t _{dLH(LO)}	—	—	30	ns
Delay Matching, High Side and Low Side Turn-Off	Δt _{dHL}	t _{dHL(HO)} - t _{dHL(LO)}	—	—	30	ns

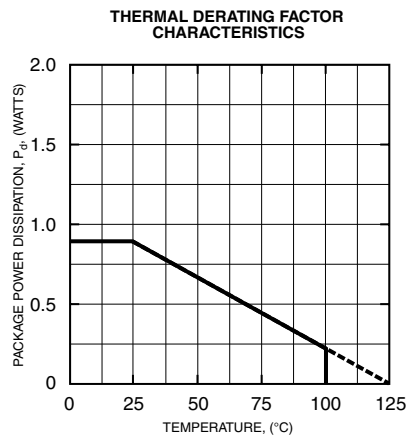

FUNCTION TABLE (X : HORL)

H _{IN}	L _{IN}	V _{BS} U _v	V _{CC} U _v	HO	LO	Behavioral State
L	L	H	H	L	L	LO = HO = Low
L	H	H	H	L	H	LO = High
H	L	H	H	H	L	HO = High
H	H	H	H	L	L	LO = HO = Low
X	L	L	H	L	L	HO = Low, V _{BS} U _v Tripped
X	H	L	H	L	H	LO = High, V _{BS} U _v Tripped
L	X	H	L	L	L	LO = Low, V _{CC} U _v Tripped
H	X	H	L	L	L	HO = LO = Low, V _{CC} U _v Tripped

NOTE: "L" state of V_{BS} U_v, V_{CC} U_v means that U_v trip voltage.
In the case of both input signals (H_{IN} and L_{IN}) are "H", output signals (HO and LO) become "L".

M81709FP

HVIC, High Voltage Half-Bridge Driver

600 Volts/±2A

TIMING DIAGRAM

1. Input/Output Timing Diagram

HIGH ACTIVE – When input signal (H_{IN} or L_{IN}) is “H”, then output signal (HO or LO) is “H”. In the case of both input signals (H_{IN} and L_{IN}) are “H”, then output signals (HO and LO) become “L”.

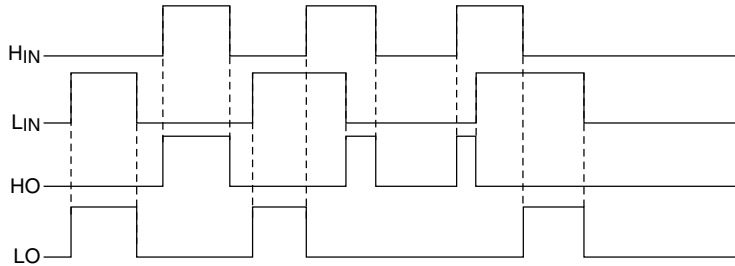

2. VCC(VBS) Supply Under Voltage Lockout Timing Diagram

When V_{CC} supply voltage keeps lower UV trip voltage ($V_{CCuvt} = V_{CCuvr} - V_{CCuvh}$) for V_{CC} supply UV filter time, output signal becomes “L”. And then, when V_{CC} supply voltage is higher than UV reset voltage, output signal LO becomes “H”.

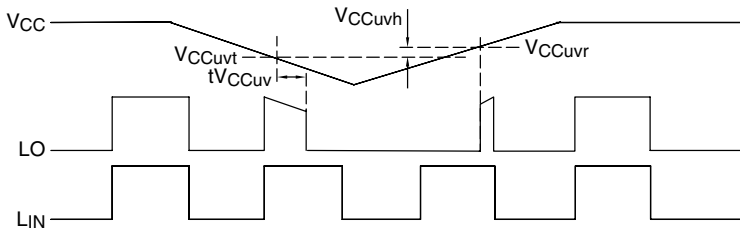

When V_{CC} supply voltage keeps lower UV trip voltage ($V_{CCuvt} = V_{CCuvr} - V_{CCuvh}$) for V_{CC} supply UV filter time, output signal becomes “L”. And then, when V_{CC} supply voltage is higher than UV reset voltage, input signal (L_{IN}) is “L”; output signal HO becomes “H”.

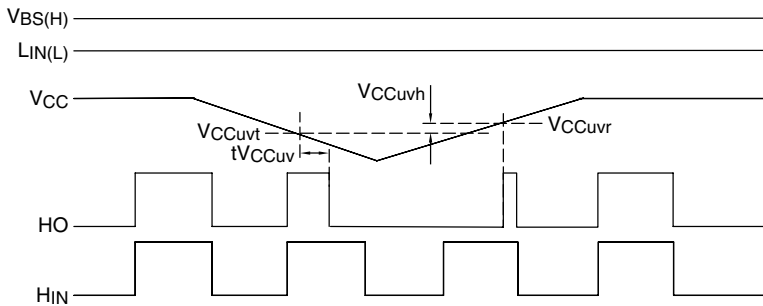

When V_{BS} supply voltage keeps lower UV trip voltage ($V_{BSuvt} = V_{BSuvr} - V_{BSuvh}$) for V_{BS} supply UV filter time, output signal becomes “L”. And then, V_{BS} supply voltage is higher than UV reset voltage, output signal HO keeps “L” until next input signal H_{IN} is “H”.

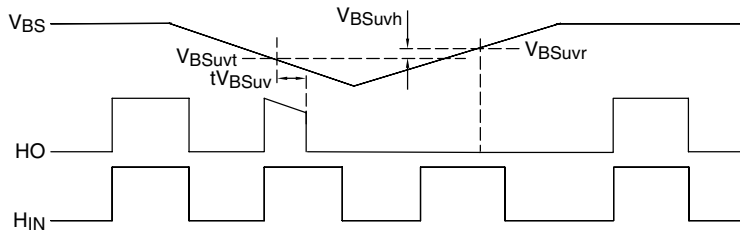

3. Allowable Supply Voltage Transient

It is recommended supplying V_{CC} first and supplying V_{BS} second. In the case of shutting off supply voltage, shut off V_{BS} firstly and shut off V_{CC} second. At the time of starting V_{CC} and V_{BS} , power supply should be increased slowly. If it is increased rapidly, output signal (HO or LO) may be “H”.

Looking for pricing, stock, or lifecycle information?

Click below to explore more details on WIN SOURCE:

 [View M81709FP on WIN SOURCE](#)

 [Powerex Inc. Information](#)

Optimize Your Supply Chain with WIN SOURCE Solutions

-  Global Sourcing Solution
-  Obsolete Management
-  Cost Control Management
-  Shortage Management
-  Alternative Solution
-  Excess Inventory Management