



**THE DATASHEET OF
M27C4002-10F1**



4 Mbit (256Kb x16) UV EPROM and OTP EPROM

Feature summary

- $5V \pm 10\%$ Supply voltage for Read operations
- Access time: 45ns
- Low Power consumption
 - Active Current 70mA at 10MHz
 - Standby current 100 μ A
- Programming Voltage: $12.75V \pm 0.25V$
- Programming Time: 100 μ s/word
- Electronic Signature
 - Manufacturer Code: 20h
 - Device Code: 44h
- ECOPACK[®] packages available

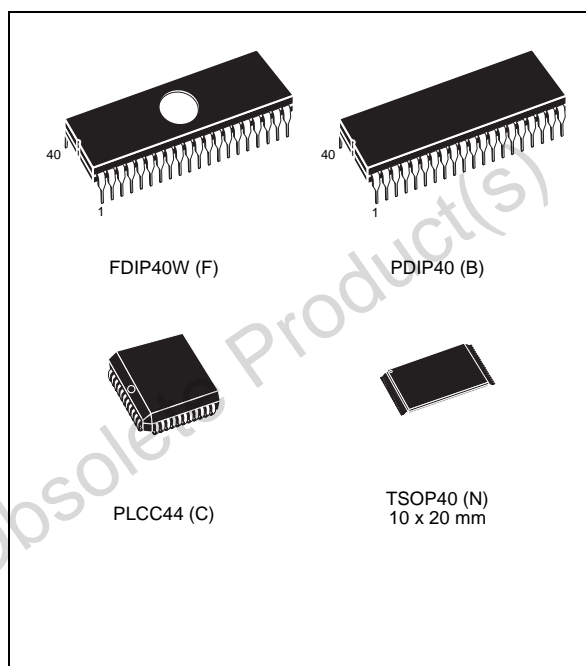

Contents

1	Summary description	5
2	Device operation	8
2.1	Read mode	8
2.2	Standby mode	8
2.3	Two line output control	8
2.4	System considerations	9
2.5	Programming	9
2.6	PRESTO II programming algorithm	9
2.7	Program Inhibit	10
2.8	Program Verify	10
2.9	Electronic Signature	10
2.10	Erase operation (applies to UV EPROM)	11
3	Maximum rating	12
4	DC and AC parameters	13
5	Package mechanical data	18
6	Part numbering	22
7	Revision history	23

List of tables

Table 1.	Signal Names	6
Table 2.	Operating modes	11
Table 3.	Electronic Signature	11
Table 4.	Absolute Maximum Ratings	12
Table 5.	AC Measurement Conditions	13
Table 6.	Capacitance	14
Table 7.	Read Mode DC Characteristics	14
Table 8.	Programming Mode DC Characteristics	14
Table 9.	Read Mode AC Characteristics 1	15
Table 10.	Read Mode AC Characteristics 2	15
Table 11.	Read Mode AC Characteristics 3	16
Table 12.	Programming Mode AC Characteristics	17
Table 13.	FDIP40W - 40 pin Ceramic Frit-seal DIP with window, Package Mechanical Data	18
Table 14.	PDIP40 - 40 pin Plastic DIP, 600 mils width, Package Mechanical Data	19
Table 15.	PLCC44 - 44 lead Plastic Leaded Chip Carrier, Package Mechanical Data.	20
Table 16.	TSOP40 - 40 lead Plastic Thin Small Outline, 10 x 20 mm, mechanical data	21
Table 17.	Ordering Information Scheme.	22
Table 18.	Document revision history	23

List of figures

Figure 1.	Logic Diagram	5
Figure 2.	DIP Connections	6
Figure 3.	LCC Connections	7
Figure 4.	TSOP Connections	7
Figure 5.	Programming Flowchart	10
Figure 6.	AC Testing Input Output Waveform	13
Figure 7.	AC Testing Load Circuit	13
Figure 8.	Read Mode AC Waveforms	16
Figure 9.	Programming and Verify Modes AC Waveforms	17
Figure 10.	FDIP40W - 40 pin Ceramic Frit-seal DIP with window, Package Outline	18
Figure 11.	PDIP40 - 40 lead Plastic DIP, 600 mils width, Package Outline	19
Figure 12.	PLCC44 - 44 lead Plastic Leaded Chip Carrier, Package Outline	20
Figure 13.	TSOP40 - 40 lead Plastic Thin Small Outline, 10 x 20 mm, Package Outline	21

1 Summary description

The M27C4002 is a 4 Mbit EPROM offered in the two ranges UV (ultra violet erase) and OTP (one time programmable). It is ideally suited for microprocessor systems requiring large programs and is organized as 262,144 words of 16 bits.

The FDIP40W (window ceramic frit-seal package) has transparent lids which allow the user to expose the chip to ultraviolet light to erase the bit pattern. A new pattern can then be written to the device by following the programming procedure.

For applications where the content is programmed only one time and erasure is not required, the M27C4002 is offered in PDIP40, PLCC44 and TSOP40 (10 x 20 mm) packages.

In order to meet environmental requirements, ST offers the M27C4002 in ECOPACK® packages.

ECOPACK packages are Lead-free. The category of second Level Interconnect is marked on the package and on the inner box label, in compliance with JEDEC Standard JESD97. The maximum ratings related to soldering conditions are also marked on the inner box label.

ECOPACK is an ST trademark. ECOPACK specifications are available at: www.st.com.

Figure 1. Logic Diagram

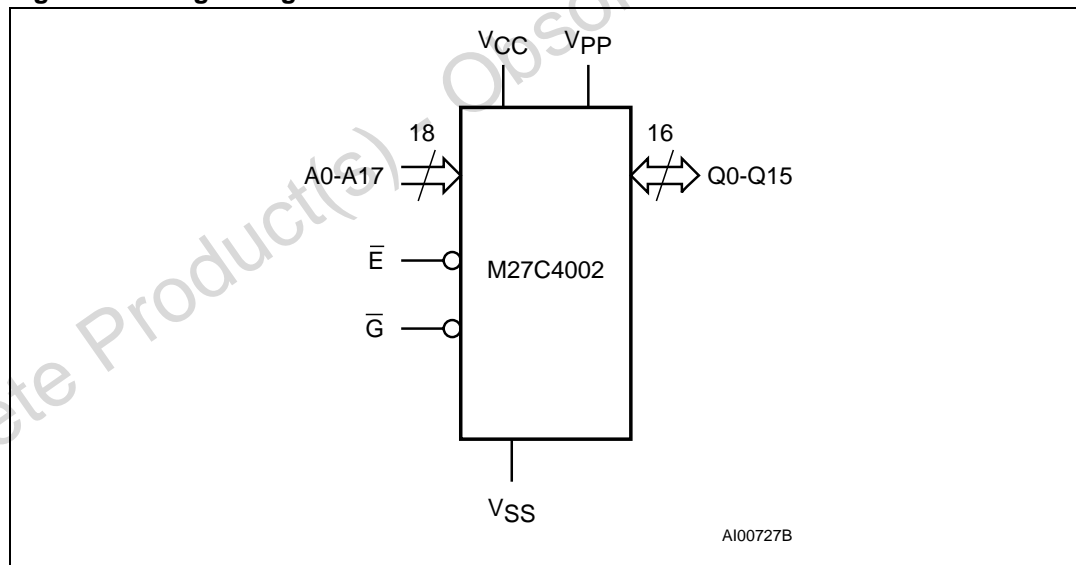

Table 1. Signal Names

A0-A17	Address Inputs
Q0-Q15	Data Outputs
\bar{E}	Chip Enable
\bar{G}	Output Enable
V _{PP}	Program Supply
V _{CC}	Supply Voltage
V _{SS}	Ground
NC	Not Connected Internally

Figure 2. DIP Connections

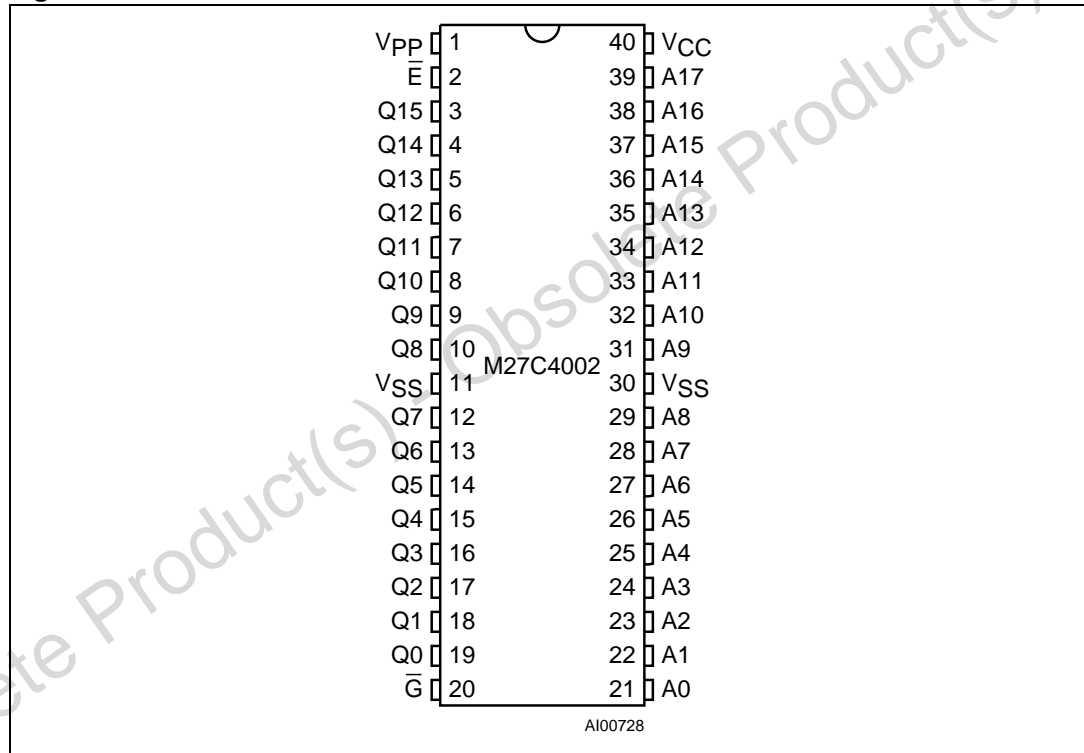

Figure 3. LCC Connections

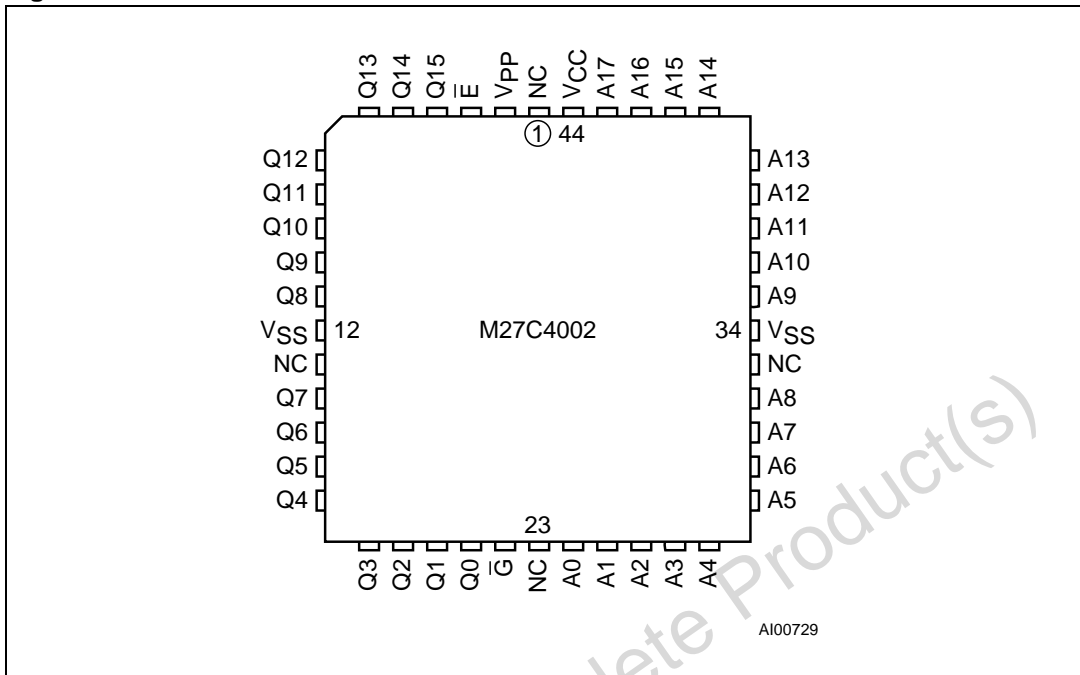
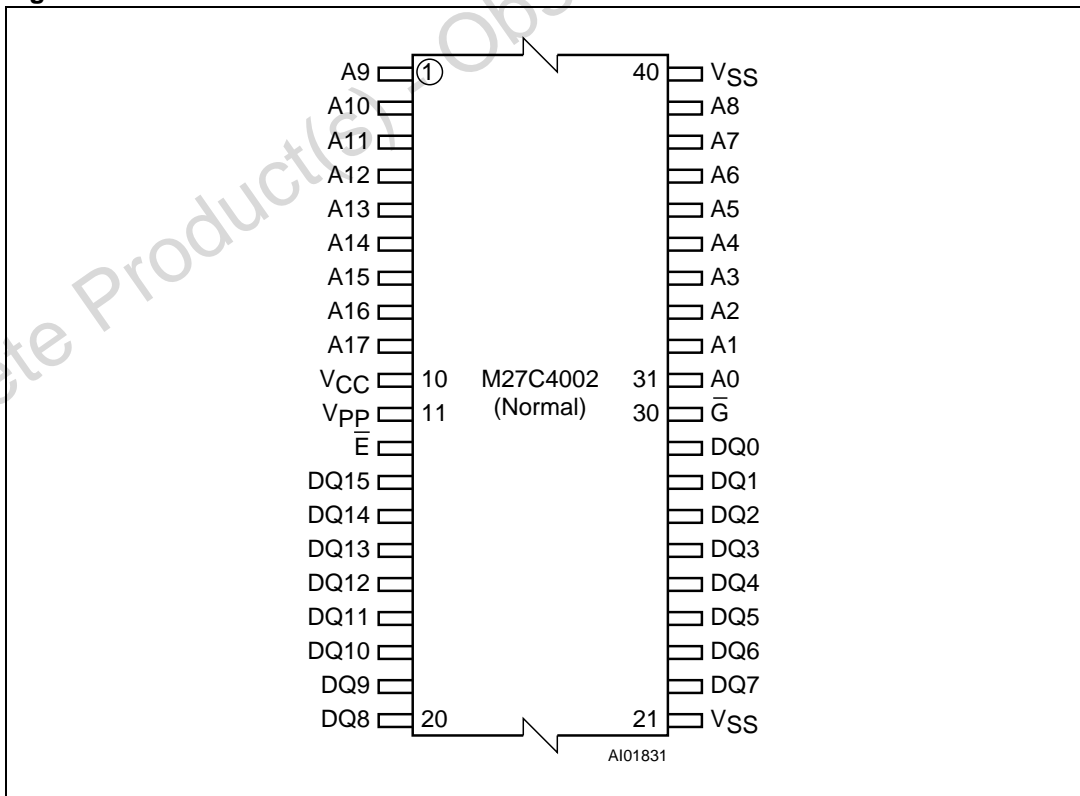

Figure 4. TSOP Connections



2 Device operation

The operating modes of the M27C4002 are listed in the Operating Modes table. A single power supply is required in the read mode. All inputs are TTL levels except for V_{PP} and 12V on A9 for Electronic Signature.

2.1 Read mode

The M27C4002 has two control functions, both of which must be logically active in order to obtain data at the outputs. Chip Enable (\bar{E}) is the power control and should be used for device selection. Output Enable (\bar{G}) is the output control and should be used to gate data to the output pins, independent of device selection. Assuming that the addresses are stable, the address access time (t_{AVQV}) is equal to the delay from \bar{E} to output (t_{ELQV}). Data is available at the output after a delay of t_{GLQV} from the falling edge of \bar{G} , assuming that \bar{E} has been low and the addresses have been stable for at least $t_{AVQV} - t_{GLQV}$.

2.2 Standby mode

The M27C4002 has a standby mode which reduces the supply current from 50mA to 100 μ A. The M27C4002 is placed in the standby mode by applying a CMOS high signal to the \bar{E} input. When in the standby mode, the outputs are in a high impedance state, independent of the \bar{G} input.

2.3 Two line output control

Because EPROMs are usually used in larger memory arrays, the product features a 2 line control function which accommodates the use of multiple memory connection. The two line control function allows:

- The lowest possible memory power dissipation
- Complete assurance that output bus contention will not occur.

For the most efficient use of these two control lines, \bar{E} should be decoded and used as the primary device selecting function, while \bar{G} should be made a common connection to all devices in the array and connected to the \overline{READ} line from the system control bus. This ensures that all deselected memory devices are in their low power standby mode and that the output pins are only active when data is required from a particular memory device.

2.4 System considerations

The power switching characteristics of Advanced CMOS EPROMs require careful decoupling of the devices. The supply current, I_{CC} , has three segments that are of interest to the system designer: the standby current level, the active current level, and transient current peaks that are produced by the falling and rising edges of \bar{E} . The magnitude of the transient current peaks is dependent on the output capacitive and inductive loading of the device. The associated transient voltage peaks can be suppressed by complying with the two line output control and by properly selected decoupling capacitors. It is recommended that a 0.1 μ F ceramic capacitor be used on every device between V_{CC} and V_{SS} . This should be a high frequency capacitor of low inherent inductance and should be placed as close to the device as possible. In addition, a 4.7 μ F bulk electrolytic capacitor should be used between V_{CC} and V_{SS} for every eight devices. The bulk capacitor should be located near the power supply connection point. The purpose of the bulk capacitor is to overcome the voltage drop caused by the inductive effects of PCB traces.

2.5 Programming

When delivered (and after each erasure for UV EPROM), all bits of the M27C4002 are in the '1' state. Data is introduced by selectively programming '0's into the desired bit locations. Although only '0's will be programmed, both '1's and '0's can be present in the data word. The only way to change a '0' to a '1' is by die exposure to ultraviolet light (UV EPROM). The M27C4002 is in the programming mode when V_{PP} input is at 12.75V, \bar{G} is at V_{IH} and \bar{E} is pulsed to V_{IL} . The data to be programmed is applied to 16 bits in parallel to the data output pins. The levels required for the address and data inputs are TTL. V_{CC} is specified to be $6.25V \pm 0.25V$.

2.6 PRESTO II programming algorithm

PRESTO II Programming Algorithm allows the whole array to be programmed with a guaranteed margin, in a typical time of 26.5 seconds. Programming with PRESTO II consists of applying a sequence of 100 μ s program pulses to each byte until a correct verify occurs (see [Figure 5](#)). During programming and verify operation, a MARGIN MODE circuit is automatically activated in order to guarantee that each cell is programmed with enough margin. No overprogram pulse is applied since the verify in MARGIN MODE provides necessary margin to each programmed cell.

Figure 5. Programming Flowchart

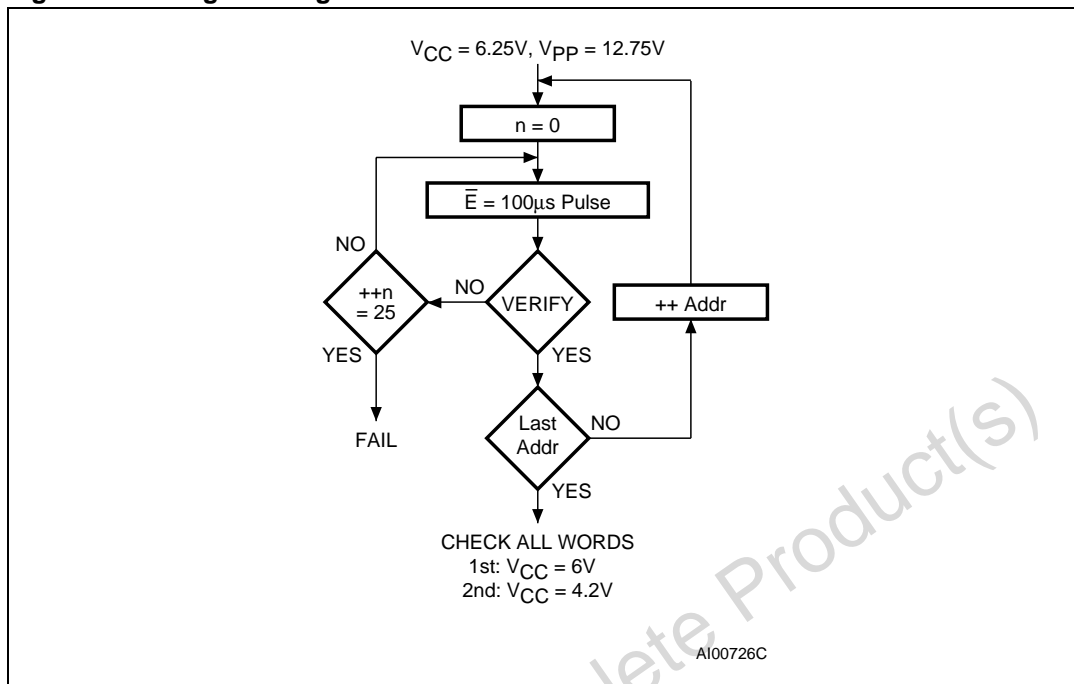

2.7 Program Inhibit

Programming of multiple M27C4002 devices in parallel with different data is also easily accomplished. Except for \bar{E} , all like inputs including \bar{G} of the parallel M27C4002 may be common. A TTL low level pulse applied to a M27C4002 \bar{E} input, with V_{PP} at 12.75V, will program that M27C4002. A high level \bar{E} input inhibits the other M27C4002 devices from being programmed.

2.8 Program Verify

A verify (read) should be performed on the programmed bits to determine that they were correctly programmed. The verify is accomplished with \bar{G} at V_{IL} , \bar{E} at V_{IH} , V_{PP} at 12.75V and V_{CC} at 6.25V.

2.9 Electronic Signature

The Electronic Signature (ES) mode allows the reading out of a binary code from an EPROM that will identify its manufacturer and type. This mode is intended for use by programming equipment to automatically match the device to be programmed with its corresponding programming algorithm. The ES mode is functional in the $25^{\circ}\text{C} \pm 5^{\circ}\text{C}$ ambient temperature range that is required when programming the M27C4002. To activate the ES mode, the programming equipment must force 11.5V to 12.5V on address line A9 of the M27C4002 with $V_{PP} = V_{CC} = 5\text{V}$. Two identifier bytes may then be sequenced from the device outputs by toggling address line A0 from V_{IL} to V_{IH} . All other address lines must be held at V_{IL} during Electronic Signature mode. Byte 0 ($A0 = V_{IL}$) represents the manufacturer code and byte 1 ($A0 = V_{IH}$) the device identifier code. For the STMicroelectronics

M27C4002, these two identifier bytes are given in [Table 3: Electronic Signature](#) and can be read-out on outputs Q7 to Q0.

2.10 Erasure operation (applies to UV EPROM)

The erasure characteristics of the M27C4002 are such that erasure begins when the cells are exposed to light with wavelengths shorter than approximately 4000 Å. It should be noted that sunlight and some type of fluorescent lamps have wavelengths in the 3000-4000 Å range. Research shows that constant exposure to room level fluorescent lighting could erase a typical M27C4002 in about 3 years, while it would take approximately 1 week to cause erasure when exposed to direct sunlight. If the M27C4002 is to be exposed to these types of lighting conditions for extended periods of time, it is suggested that opaque labels be put over the M27C4002 window to prevent unintentional erasure. The recommended erasure procedure for the M27C4002 is exposure to short wave ultraviolet light which has wavelength 2537 Å. The integrated dose (i.e. UV intensity x exposure time) for erasure should be a minimum of 15 W-sec/cm². The erasure time with this dosage is approximately 15 to 20 minutes using an ultraviolet lamp with 12000 µW/cm² power rating. The M27C4002 should be placed within 2.5cm (1 inch) of the lamp tubes during the erasure. Some lamps have a filter on their tubes which should be removed before erasure.

Table 2. Operating modes⁽¹⁾

Mode	\bar{E}	\bar{G}	A9	V _{PP}	Q15-Q0
Read	V _{IL}	V _{IL}	X	V _{CC} or V _{SS}	Data Out
Output Disable	V _{IL}	V _{IH}	X	V _{CC} or V _{SS}	Hi-Z
Program	V _{IL} Pulse	V _{IH}	X	V _{PP}	Data In
Verify	V _{IH}	V _{IL}	X	V _{PP}	Data Out
Program Inhibit	V _{IH}	V _{IH}	X	V _{PP}	Hi-Z
Standby	V _{IH}	X	X	V _{CC} or V _{SS}	Hi-Z
Electronic Signature	V _{IL}	V _{IL}	V _{ID}	V _{CC}	Codes

1. X = V_{IH} or V_{IL}, V_{ID} = 12V ± 0.5V.

Table 3. Electronic Signature⁽¹⁾

Identifier	A0	Q7	Q6	Q5	Q4	Q3	Q2	Q1	Q0	Hex Data
Manufacturer's Code	V _{IL}	0	0	1	0	0	0	0	0	20h
Device Code	V _{IH}	0	1	0	0	0	1	0	0	44h

1. Outputs Q15-Q8 are set to '0'.

3 Maximum rating

Stressing the device above the rating listed in the Absolute Maximum Ratings table may cause permanent damage to the device. These are stress ratings only and operation of the device at these or any other conditions above those indicated in the Operating sections of this specification is not implied. Exposure to Absolute Maximum Rating conditions for extended periods may affect device reliability. Refer also to the STMicroelectronics SURE Program and other relevant quality documents.

Table 4. Absolute Maximum Ratings

Symbol	Parameter	Value	Unit
T_A	Ambient Operating Temperature ⁽¹⁾	-40 to 125	°C
T_{BIAS}	Temperature Under Bias	-50 to 125	°C
T_{STG}	Storage Temperature	-65 to 150	°C
$V_{IO}^{(2)}$	Input or Output Voltage (except A9)	-2 to 7	V
V_{CC}	Supply Voltage	-2 to 7	V
$V_{A9}^{(2)}$	A9 Voltage	-2 to 13.5	V
V_{PP}	Program Supply Voltage	-2 to 14	V

1. Depends on range.
2. Minimum DC voltage on Input or Output is -0.5V with possible undershoot to -2.0V for a period less than 20ns. Maximum DC voltage on Output is $V_{CC} + 0.5V$ with possible overshoot to $V_{CC} + 2V$ for a period less than 20ns.

4 DC and AC parameters

This section summarizes the operating and measurement conditions, and the DC and AC characteristics of the device. The parameters in the DC and AC Characteristic tables that follow are derived from tests performed under the Measurement Conditions summarized in the relevant tables. Designers should check that the operating conditions in their circuit match the measurement conditions when relying on the quoted parameters.

Table 5. AC Measurement Conditions

Parameter	High Speed	Standard
Input Rise and Fall Times	$\leq 10\text{ns}$	$\leq 20\text{ns}$
Input Pulse Voltages	0 to 3V	0.4V to 2.4V
Input and Output Timing Ref. Voltages	1.5V	0.8V and 2V

Figure 6. AC Testing Input Output Waveform

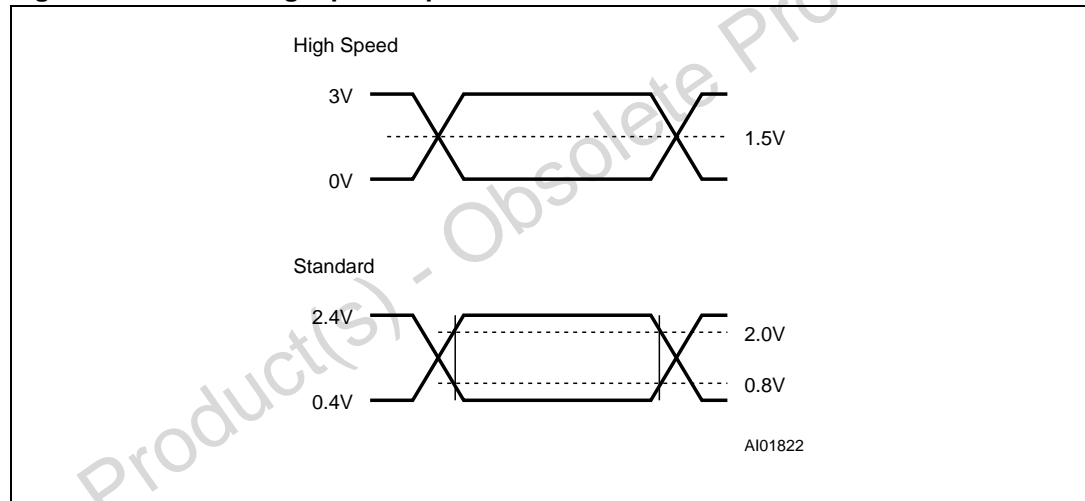

Figure 7. AC Testing Load Circuit

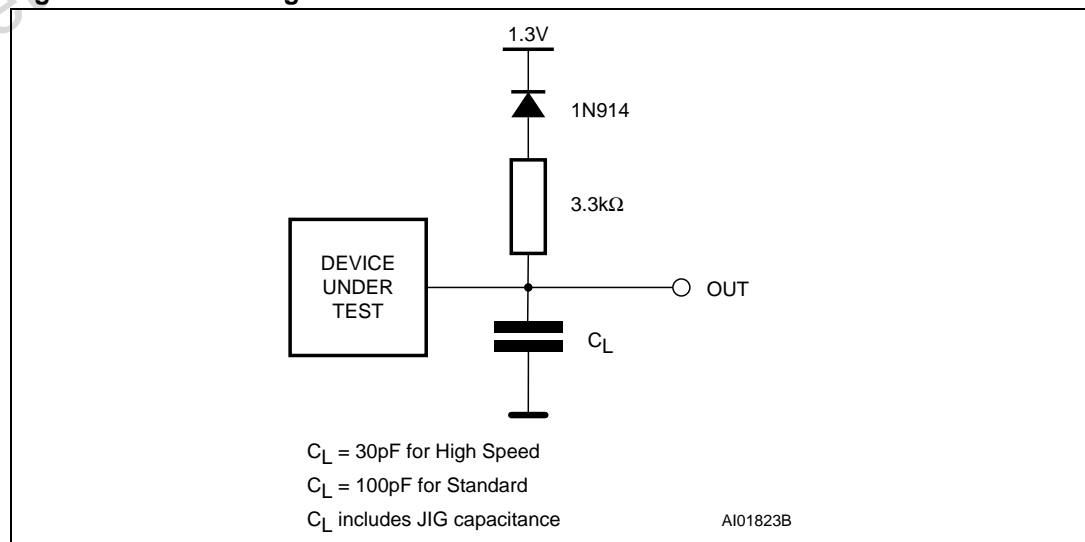

Table 6. Capacitance⁽¹⁾⁽²⁾

Symbol	Parameter	Test Condition	Min	Max	Unit
C _{IN}	Input Capacitance	V _{IN} = 0V		6	pF
C _{OUT}	Output Capacitance	V _{OUT} = 0V		12	pF

1. T_A = 25 °C, f = 1 MHz.
2. Sampled only, not 100% tested.

Table 7. Read Mode DC Characteristics⁽¹⁾⁽²⁾

Symbol	Parameter	Test Condition	Min	Max	Unit
I _{LI}	Input Leakage Current	0V ≤ V _{IN} ≤ V _{CC}		±10	µA
I _{LO}	Output Leakage Current	0V ≤ V _{OUT} ≤ V _{CC}		±10	µA
I _{CC}	Supply Current	$\bar{E} = V_{IL}, \bar{G} = V_{IL}, I_{OUT} = 0mA, f = 10MHz$		70	mA
		$\bar{E} = V_{IL}, \bar{G} = V_{IL}, I_{OUT} = 0mA, f = 5MHz$		50	mA
I _{CC1}	Supply Current (Standby) TTL	$\bar{E} = V_{IH}$		1	mA
I _{CC2}	Supply Current (Standby) CMOS	$\bar{E} > V_{CC} - 0.2V$		100	µA
I _{PP}	Program Current	V _{PP} = V _{CC}		10	µA
V _{IL}	Input Low Voltage		-0.3	0.8	V
V _{IH} ⁽³⁾	Input High Voltage		2	V _{CC} + 1	V
V _{OL}	Output Low Voltage	I _{OL} = 2.1mA		0.4	V
V _{OH}	Output High Voltage TTL	I _{OH} = -400µA	2.4		V
	Output High Voltage CMOS	I _{OH} = -100µA	V _{CC} - 0.7V		V

1. T_A = 0 to 70°C or -40 to 85°C; V_{CC} = 5V ± 5% or 5V ± 10%; V_{PP} = V_{CC}.
2. V_{CC} must be applied simultaneously with or before V_{PP} and removed simultaneously or after V_{PP}.
3. Maximum DC voltage on Output is V_{CC} + 0.5V.

Table 8. Programming Mode DC Characteristics⁽¹⁾⁽²⁾

Symbol	Parameter	Test Condition	Min	Max	Unit
I _{LI}	Input Leakage Current	V _{IL} ≤ V _{IN} ≤ V _{IH}		±10	µA
I _{CC}	Supply Current			50	mA
I _{PP}	Program Current	$\bar{E} = V_{IL}$		50	mA
V _{IL}	Input Low Voltage		-0.3	0.8	V
V _{IH}	Input High Voltage		2	V _{CC} + 0.5	V
V _{OL}	Output Low Voltage	I _{OL} = 2.1mA		0.4	V
V _{OH}	Output High Voltage TTL	I _{OH} = -400µA	2.4		V
V _{ID}	A9 Voltage		11.5	12.5	V

1. T_A = 25 °C; V_{CC} = 6.25V ± 0.25V; V_{PP} = 12.75V ± 0.25V.
2. V_{CC} must be applied simultaneously with or before V_{PP} and removed simultaneously or after V_{PP}.

Table 9. Read Mode AC Characteristics 1⁽¹⁾⁽²⁾

Symbol	Alt	Parameter	Test Condition	M27C4002						Unit
				- 45 ⁽³⁾		-60 ⁽³⁾		-70		
				Min	Max	Min	Max	Min	Max	
t _{AVQV}	t _{ACC}	Address Valid to Output Valid	$\bar{E} = V_{IL}, \bar{G} = V_{IL}$		45		60		70	ns
t _{ELQV}	t _{CE}	Chip Enable Low to Output Valid	$\bar{G} = V_{IL}$		45		60		70	ns
t _{GLQV}	t _{OE}	Output Enable Low to Output Valid	$\bar{E} = V_{IL}$		25		30		35	ns
t _{EHQZ} ⁽⁴⁾	t _{DF}	Chip Enable High to Output Hi-Z	$\bar{G} = V_{IL}$	0	30	0	30	0	30	ns
t _{GHQZ} ⁽⁴⁾	t _{DF}	Output Enable High to Output Hi-Z	$\bar{E} = V_{IL}$	0	30	0	30	0	30	ns
t _{AXQX}	t _{OH}	Address Transition to Output Transition	$\bar{E} = V_{IL}, \bar{G} = V_{IL}$	0		0		0		ns

1. T_A = 0 to 70°C or -40 to 85°C; V_{CC} = 5V ± 5% or 5V ± 10%; V_{PP} = V_{CC}.
2. V_{CC} must be applied simultaneously with or before V_{PP} and removed simultaneously or after V_{PP}.
3. Speed obtained with High Speed AC measurement conditions.
4. Sampled only, not 100% tested.

Table 10. Read Mode AC Characteristics 2⁽¹⁾⁽²⁾

Symbol	Alt	Parameter	Test Condition	M27C4002						Unit
				-80		-90		-10		
				Min	Max	Min	Max	Min	Max	
t _{AVQV}	t _{ACC}	Address Valid to Output Valid	$\bar{E} = V_{IL}, \bar{G} = V_{IL}$		80		90		100	ns
t _{ELQV}	t _{CE}	Chip Enable Low to Output Valid	$\bar{G} = V_{IL}$		80		90		100	ns
t _{GLQV}	t _{OE}	Output Enable Low to Output Valid	$\bar{E} = V_{IL}$		40		40		50	ns
t _{EHQZ} ⁽³⁾	t _{DF}	Chip Enable High to Output Hi-Z	$\bar{G} = V_{IL}$	0	30	0	30	0	30	ns
t _{GHQZ} ⁽³⁾	t _{DF}	Output Enable High to Output Hi-Z	$\bar{E} = V_{IL}$	0	30	0	30	0	30	ns
t _{AXQX}	t _{OH}	Address Transition to Output Transition	$\bar{E} = V_{IL}, \bar{G} = V_{IL}$	0		0		0		ns

1. T_A = 0 to 70°C or -40 to 85°C; V_{CC} = 5V ± 5% or 5V ± 10%; V_{PP} = V_{CC}.
2. V_{CC} must be applied simultaneously with or before V_{PP} and removed simultaneously or after V_{PP}.
3. Sampled only, not 100% tested.

Table 11. Read Mode AC Characteristics 3⁽¹⁾⁽²⁾

Symbol	Alt	Parameter	Test Condition	M27C4002						Unit
				-12		-15		-20		
				Min	Max	Min	Max	Min	Max	
t _{AVQV}	t _{ACC}	Address Valid to Output Valid	$\bar{E} = V_{IL}, \bar{G} = V_{IL}$		120		150		200	ns
t _{ELQV}	t _{CE}	Chip Enable Low to Output Valid	$\bar{G} = V_{IL}$		120		150		200	ns
t _{GLQV}	t _{OE}	Output Enable Low to Output Valid	$\bar{E} = V_{IL}$		60		60		70	ns
t _{EHQZ} ⁽³⁾	t _{DF}	Chip Enable High to Output Hi-Z	$\bar{G} = V_{IL}$	0	40	0	50	0	80	ns
t _{GHQZ} ⁽³⁾	t _{DF}	Output Enable High to Output Hi-Z	$\bar{E} = V_{IL}$	0	40	0	50	0	80	ns
t _{AXQX}	t _{OH}	Address Transition to Output Transition	$\bar{E} = V_{IL}, \bar{G} = V_{IL}$	0		0		0		ns

1. T_A = 0 to 70°C or -40 to 85°C; V_{CC} = 5V ± 5% or 5V ± 10%; V_{PP} = V_{CC}.
2. V_{CC} must be applied simultaneously with or before V_{PP} and removed simultaneously or after V_{PP}.
3. Sampled only, not 100% tested.

Figure 8. Read Mode AC Waveforms

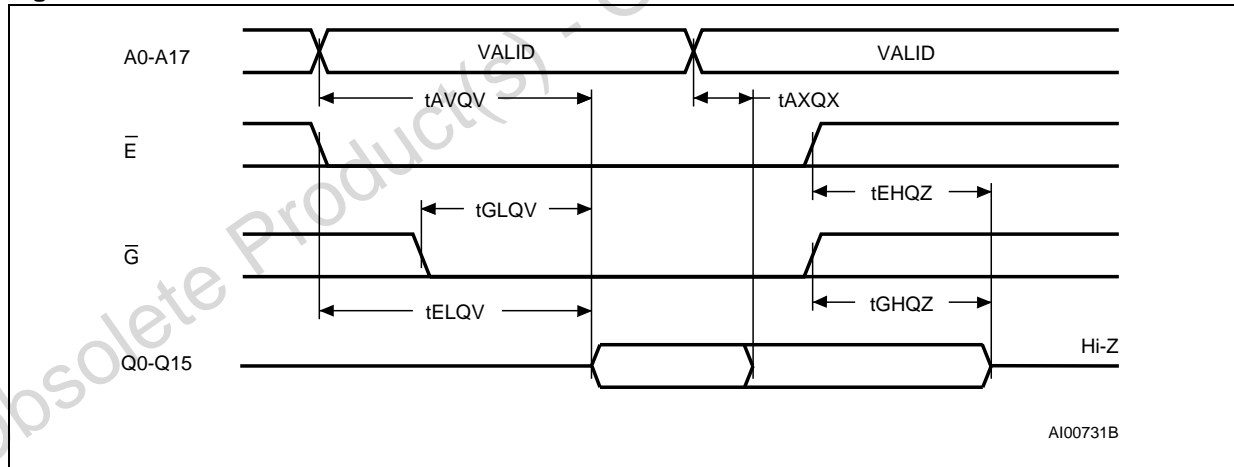
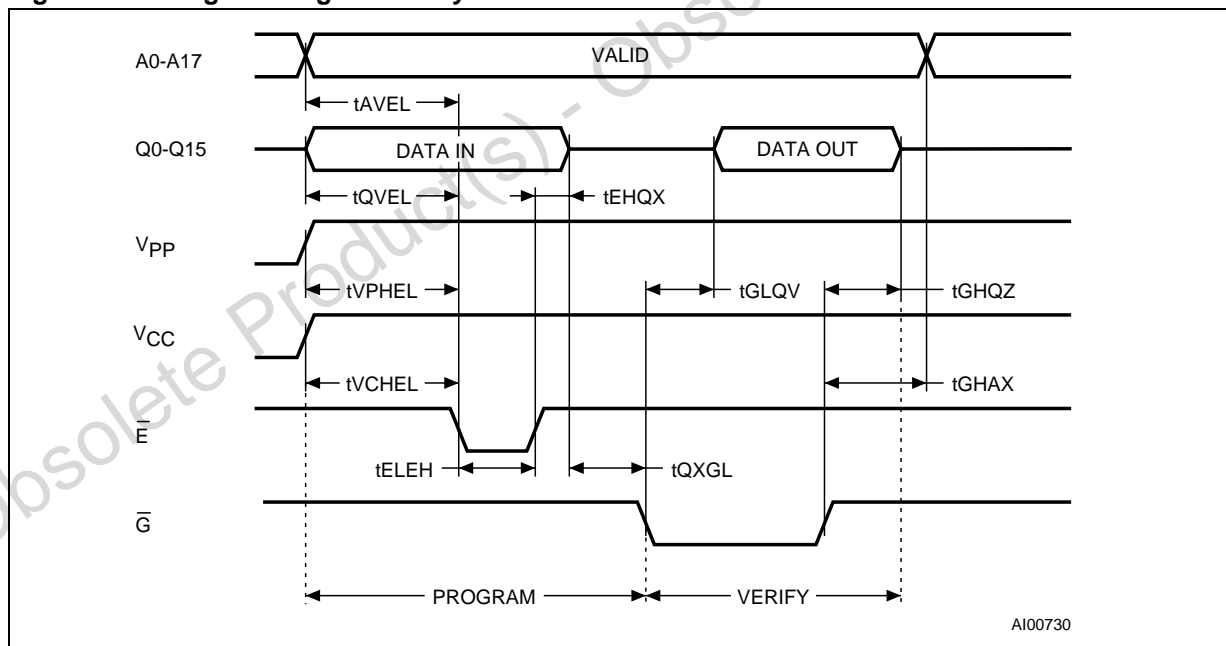

Table 12. Programming Mode AC Characteristics⁽¹⁾⁽²⁾⁽³⁾

Symbol	Alt	Parameter	Test Condition	Min	Max	Unit
t_{AVEL}	t_{AS}	Address Valid to Chip Enable Low		2		μs
t_{QVEL}	t_{DS}	Input Valid to Chip Enable Low		2		μs
t_{VPHEL}	t_{VPS}	V_{PP} High to Chip Enable Low		2		μs
t_{VCHEL}	t_{VCS}	V_{CC} High to Chip Enable Low		2		μs
t_{ELEH}	t_{PW}	Chip Enable Program Pulse Width		95	105	μs
t_{EHQX}	t_{DH}	Chip Enable High to Input Transition		2		μs
t_{QXGL}	t_{OES}	Input Transition to Output Enable Low		2		μs
t_{GLQV}	t_{OE}	Output Enable Low to Output Valid			100	ns
t_{GHQZ}	t_{DFP}	Output Enable High to Output Hi-Z		0	130	ns
t_{GHAX}	t_{AH}	Output Enable High to Address Transition		0		ns

- $T_A = 25\text{ }^\circ\text{C}$; $V_{CC} = 6.25\text{V} \pm 0.25\text{V}$; $V_{PP} = 12.75\text{V} \pm 0.25\text{V}$.
- V_{CC} must be applied simultaneously with or before V_{PP} and removed simultaneously or after V_{PP} .
- Sampled only, not 100% tested.

Figure 9. Programming and Verify Modes AC Waveforms



5 Package mechanical data

Figure 10. FDIP40W - 40 pin Ceramic Frit-seal DIP with window, Package Outline

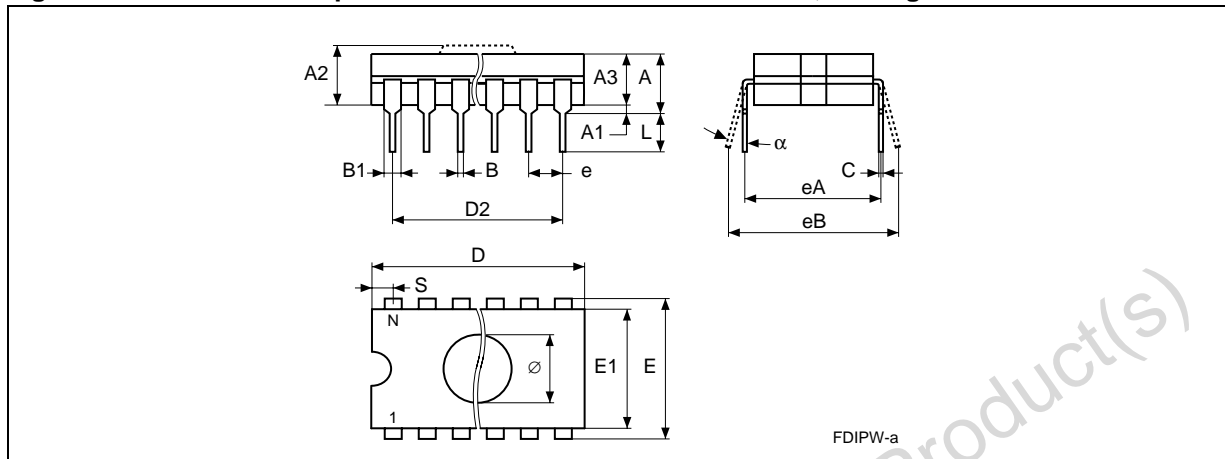

1. Drawing is not to scale.

Table 13. FDIP40W - 40 pin Ceramic Frit-seal DIP with window, Package Mechanical Data

Symbol	millimeters			inches			
	Typ	Min	Max	Typ	Min	Max	
A			5.72			0.225	
A1		0.51	1.40		0.020	0.055	
A2		3.91	4.57		0.154	0.180	
A3		3.89	4.50		0.153	0.177	
B		0.41	0.56		0.016	0.022	
B1	1.45	–	–	0.057	–	–	
C		0.23	0.30		0.009	0.012	
D		51.79	52.60		2.039	2.071	
D2	48.26	–	–	1.900	–	–	
E	15.24	–	–	0.600	–	–	
E1		13.06	13.36		0.514	0.526	
e	2.54	–	–	0.100	–	–	
eA	14.99	–	–	0.590	–	–	
eB		16.18	18.03		0.637	0.710	
L		3.18			0.125		
S		1.52	2.49		0.060	0.098	
∅	7.62	–	–	0.300	–	–	
α		4°	11°		4°	11°	
N		40				40	

Figure 11. PDIP40 - 40 lead Plastic DIP, 600 mils width, Package Outline

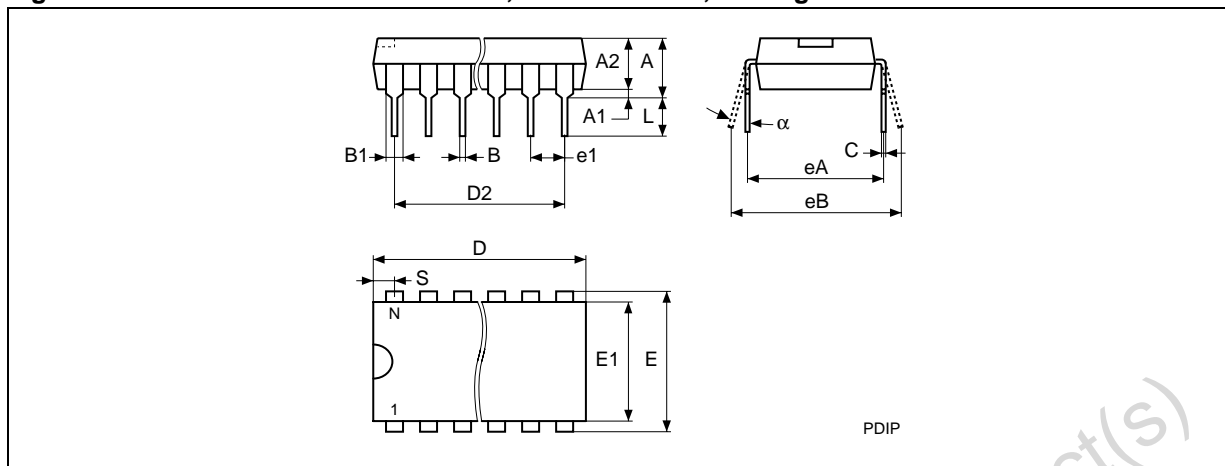

1. Drawing is not to scale.

Table 14. PDIP40 - 40 pin Plastic DIP, 600 mils width, Package Mechanical Data

Symbol	millimeters			inches			
	Typ	Min	Max	Typ	Min	Max	
A	4.45	–	–	0.175	–	–	
A1	0.64	0.38	–	0.025	0.015	–	
A2		3.56	3.91		0.140	0.154	
B		0.38	0.53		0.015	0.021	
B1		1.14	1.78		0.045	0.070	
C		0.20	0.31		0.008	0.012	
D		51.78	52.58		2.039	2.070	
D2	48.26	–	–	1.900	–	–	
E		14.80	16.26		0.583	0.640	
E1		13.46	13.99		0.530	0.551	
e1	2.54	–	–	0.100	–	–	
eA	15.24	–	–	0.600	–	–	
eB		15.24	17.78		0.600	0.700	
L		3.05	3.81		0.120	0.150	
S		1.52	2.29		0.060	0.090	
α		0°	15°		0°	15°	
N		40				40	

Figure 12. PLCC44 - 44 lead Plastic Leaded Chip Carrier, Package Outline

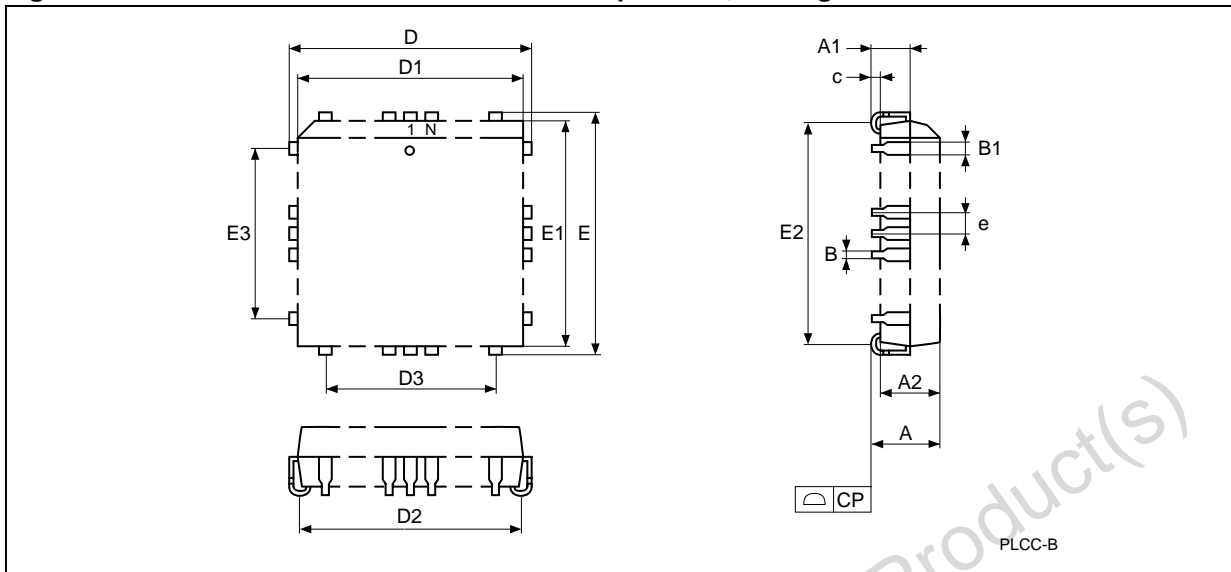

1. Drawing is not to scale.

Table 15. PLCC44 - 44 lead Plastic Leaded Chip Carrier, Package Mechanical Data

Symbol	millimeters			inches		
	Typ	Min	Max	Typ	Min	Max
A		4.200	4.570		0.1654	0.1799
A1		2.290	3.040		0.0902	0.1197
A2		3.650	3.700		0.1437	0.1457
B		0.331	0.533		0.0130	0.0210
B1		0.661	0.812		0.0260	0.0320
CP			0.101			0.0040
c	0.510			0.0201		
D		17.400	17.650		0.6850	0.6949
D1		16.510	16.662		0.6500	0.6560
D2		14.990	16.000		0.5902	0.6299
D3	12.700	–	–	0.5000	–	–
E		17.400	17.650		0.6850	0.6949
E1		16.510	16.660		0.6500	0.6559
E2		14.990	16.000		0.5902	0.6299
E3	12.700	–	–	0.5000	–	–
e	1.270	–	–	0.0500	–	–
N	44			44		

Figure 13. TSOP40 - 40 lead Plastic Thin Small Outline, 10 x 20 mm, Package Outline

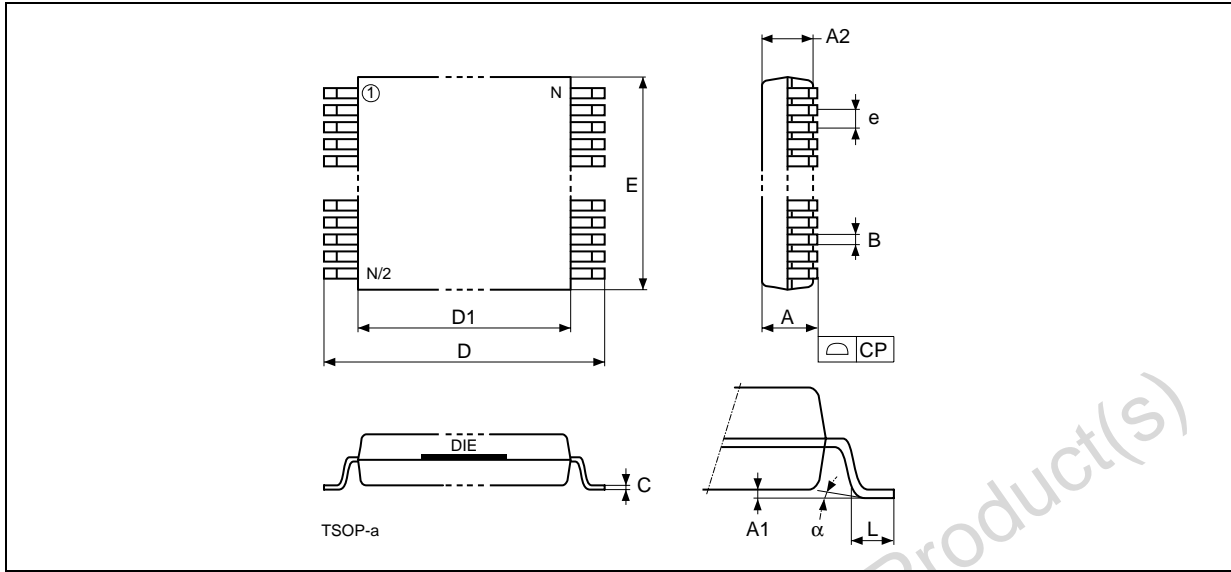

1. Drawing is not to scale.

Table 16. TSOP40 - 40 lead Plastic Thin Small Outline, 10 x 20 mm, mechanical data

Symbol	millimeters			inches		
	Typ	Min	Max	Typ	Min	Max
A			1.200			0.0472
A1		0.050	0.150		0.0020	0.0059
A2		0.950	1.050		0.0374	0.0413
B		0.170	0.270		0.0067	0.0106
C		0.100	0.210		0.0039	0.0083
CP			0.100			0.0039
D		19.800	20.200		0.7795	0.7953
D1		18.300	18.500		0.7205	0.7283
e	0.500	—	—	0.0197	—	—
E		9.900	10.100		0.3898	0.3976
L		0.500	0.700		0.0197	0.0276
alpha		0	5		0	5
N	40			40		

6 Part numbering

Table 17. Ordering Information Scheme

Example:	M27C4002	-80	X	C	1	TR
Device Type	M27					
Supply Voltage	C = 5V					
Device Function	4002 = 4 Mbit (256Kb x16)					
Speed	-45 = 45 ns ⁽¹⁾ -60 ⁽¹⁾ = 60 ns -70 = 70 ns -80 = 80 ns -90 = 90 ns -10 = 100 ns -12 = 120 ns -15 = 150 ns -20 = 200 ns					
V_{CC} Tolerance	blank = ± 10% X = ± 5%					
Package	F = FDIP40W B = PDIP40 C = PLCC44 N = TSOP40: 10 x 20 mm					
Temperature Range	1 = 0 to 70 °C 6 = -40 to 85 °C					
Options	TR = Tape & Reel Packing					

1. High Speed, see [Section 4: DC and AC parameters](#) for further information.

For a list of available options (Speed, Package, etc...) or for further information on any aspect of this device, please contact the STMicroelectronics Sales Office nearest to you.

7 Revision history

Table 18. Document revision history

Date	Revision	Changes
September 1998	1	First Issue
25-Sep-2000	2	AN620 Reference removed
30-Aug-2001	3	70ns speed class added
06-Apr-2006	4	Datasheet converted to new corporate template. Packages are ECOPACK® compliant. JLCCC32W package removed. PLCC44 outline and mechanical data. TSOP40 10x20mm mechanical data updated. Additional Burn-in options removed from Table 17: Ordering Information Scheme .

Please Read Carefully:

Information in this document is provided solely in connection with ST products. STMicroelectronics NV and its subsidiaries ("ST") reserve the right to make changes, corrections, modifications or improvements, to this document, and the products and services described herein at any time, without notice.

All ST products are sold pursuant to ST's terms and conditions of sale.

Purchasers are solely responsible for the choice, selection and use of the ST products and services described herein, and ST assumes no liability whatsoever relating to the choice, selection or use of the ST products and services described herein.

No license, express or implied, by estoppel or otherwise, to any intellectual property rights is granted under this document. If any part of this document refers to any third party products or services it shall not be deemed a license grant by ST for the use of such third party products or services, or any intellectual property contained therein or considered as a warranty covering the use in any manner whatsoever of such third party products or services or any intellectual property contained therein.

UNLESS OTHERWISE SET FORTH IN ST'S TERMS AND CONDITIONS OF SALE ST DISCLAIMS ANY EXPRESS OR IMPLIED WARRANTY WITH RESPECT TO THE USE AND/OR SALE OF ST PRODUCTS INCLUDING WITHOUT LIMITATION IMPLIED WARRANTIES OF MERCHANTABILITY, FITNESS FOR A PARTICULAR PURPOSE (AND THEIR EQUIVALENTS UNDER THE LAWS OF ANY JURISDICTION), OR INFRINGEMENT OF ANY PATENT, COPYRIGHT OR OTHER INTELLECTUAL PROPERTY RIGHT.

UNLESS EXPRESSLY APPROVED IN WRITING BY AN AUTHORIZED REPRESENTATIVE OF ST, ST PRODUCTS ARE NOT DESIGNED, AUTHORIZED OR WARRANTED FOR USE IN MILITARY, AIR CRAFT, SPACE, LIFE SAVING, OR LIFE SUSTAINING APPLICATIONS, NOR IN PRODUCTS OR SYSTEMS, WHERE FAILURE OR MALFUNCTION MAY RESULT IN PERSONAL INJURY, DEATH, OR SEVERE PROPERTY OR ENVIRONMENTAL DAMAGE.

Resale of ST products with provisions different from the statements and/or technical features set forth in this document shall immediately void any warranty granted by ST for the ST product or service described herein and shall not create or extend in any manner whatsoever, any liability of ST.

ST and the ST logo are trademarks or registered trademarks of ST in various countries.

Information in this document supersedes and replaces all information previously supplied.

The ST logo is a registered trademark of STMicroelectronics. All other names are the property of their respective owners.

© 2006 STMicroelectronics - All rights reserved



STMicroelectronics group of companies

Australia - Belgium - Brazil - Canada - China - Czech Republic - Finland - France - Germany - Hong Kong - India - Israel - Italy - Japan - Malaysia - Malta - Morocco - Singapore - Spain - Sweden - Switzerland - United Kingdom - United States of America







www.st.com

Looking for pricing, stock, or lifecycle information?

Click below to explore more details on WIN SOURCE:

-  [View M27C4002-10F1](#) on WIN SOURCE
-  [STMicroelectronics](#) Information

Optimize Your Supply Chain with WIN SOURCE Solutions

-  Global Sourcing Solution
-  Obsolete Management
-  Cost Control Management
-  Shortage Management
-  Alternative Solution
-  Excess Inventory Management