



ON Semiconductor®

<http://onsemi.com>

LV8136V

Bi-CMOS IC

For Brushless Motor Drive

Direct PWM Drive, Quiet Predriver IC

Overview

The LV8136V is a PWM system predriver IC designed for three-phase brushless motors.

This IC reduces motor driving noise by using a high-efficiency, quiet PWM drive (150-degree drive system).

It incorporates a full complement of protection circuits and, by combining it with a hybrid IC in the STK611 or STK5C4 series, the number of components used can be reduced and a high level of reliability can be achieved. Furthermore, its power-saving mode enables the power consumption in the standby mode to be reduced to zero. This IC is optimally suited for driving various large-size motors such as those used in air conditioners and hot-water heaters.

Features

- Three-phase bipolar drive
- Quiet PWM drive (150-degree current-carrying)
- Supports drive phase control (15-degree lead angle for 150-degree current-carrying drive. From this state, a lead angle from 0 to 28 degrees can be set in 16 steps)
- Supports power saving mode(power saving mode at CTL pin voltage of 1.0V (typ) or less; $I_{CC} = 0\text{mA}$, HB pin turned off)
- Supports bootstrap (maximum duty limit)
- Automatic recovery type constraint protection circuit
- Forward/reverse switching circuit, Hall bias pin
- Current limiter circuit, low-voltage protection circuit, and thermal shutdown protection circuit
- FG1 and FG3 output (360-degree electrical angle/1 pulse and 3 pulses)

LV8136V

Specifications

Absolute Maximum Ratings at $T_a = 25^\circ\text{C}$

Parameter	Symbol	Conditions	Ratings	Unit
Supply voltage	V_{CC} max	V_{CC} pin	18	V
Output current	I_O max		15	mA
Allowable power dissipation	P_d max1	Independent IC	0.45	W
	P_d max2	Mounted on a specified circuit board.*	1.05	W
CTL pin applied voltage	V_{CTL} max		18	V
FG1,FG3 pin applied voltage	V_{FG1} max V_{FG3} max		18	V
Junction temperature	T_j max		150	$^\circ\text{C}$
Operating temperature	T_{opr}		-40 to +105	$^\circ\text{C}$
Storage temperature	T_{stg}		-55 to +150	$^\circ\text{C}$

* Specified circuit board : 114.3mm × 76.1mm × 1.6mm, glass epoxy

Note 1) Absolute maximum ratings represent the values that cannot be exceeded for any length of time.

Note 2) Even when the device is used within the range of absolute maximum ratings, as a result of continuous usage under high temperature, high current, high voltage, or drastic temperature change, the reliability of the IC may be degraded. Please contact us for further details.

Stresses exceeding Maximum Ratings may damage the device. Maximum Ratings are stress ratings only. Functional operation above the Recommended Operating Conditions is not implied. Extended exposure to stresses above the Recommended Operating Conditions may affect device reliability.

Allowable Operating range at $T_a = 25^\circ\text{C}$

Parameter	Symbol	Conditions	Ratings	Unit
Supply voltage range	V_{CC}		9.5 to 16.5	V
5V constant voltage output current	I_{REG}		10	mA
HB pin output current	I_{HB}		30	mA
FG1,FG3 pin output current	I_{FG1} , I_{FG3}		10	mA

Electrical Characteristics at $T_a = 25^\circ\text{C}$, $V_{CC} = 15\text{V}$

Parameter	Symbol	Conditions	Ratings			Unit
			min	typ	max	
Supply current 1	I_{CC1}			5.0	8.0	mA
Supply current 2	I_{CC2}	At stop CTL ≤ 1.0V typ		0	20	μA
Output Block						
High level output voltage	V_{HO}	$I_O = -10\text{mA}$	VREG-0.35	VREG-0.15		V
Low level output voltage	V_{LO}	$I_O = 10\text{mA}$		0.15	0.3	V
Lower output ON resistance	R_{ONL}	$I_O = 10\text{mA}$		15	30	Ω
Upper output ON resistance	R_{ONH}	$I_O = -10\text{mA}$		15	35	Ω
Output leakage current	I_{Oleak}				10	μA
Minimum output pulse width	T_{min}			2.0	4.0	μs
Output minimum dead time	T_{dt}			2.0	4.0	μs
5V Constant Voltage Output						
Output voltage	VREG	$I_O = -5\text{mA}$	4.7	5.0	5.3	V
Voltage fluctuation	ΔV (REG1)	$V_{CC} = 9.5$ to 16.5V , $I_O = -5\text{mA}$			100	mV
Load fluctuation	ΔV (REG2)	$I_O = -5$ to -10mA			100	mV
Hall Amplifier						
Input bias current	I_B (HA)		-2		0	μA
Common-mode input voltage range 1	VICM1	When a Hall element is used	0.3		VREG-1.7	V
Common-mode input voltage range 2	VICM2	Single-sided input bias mode (when a Hall IC is used)	0		VREG	V
Hall input sensitivity	VHIN	Sine wave, Hall element offset = 0V	80			mVp-p
Hysteresis width	ΔV_{IN} (HA)		9	20	40	mV
Input voltage Low → High	VSLH		5	11	19	mV
Input voltage High → Low	VSHL		-19	-11	-5	mV

Continued on next page.

LV8136V

Continued from preceding page.

Parameter	Symbol	Conditions	Ratings			Unit
			min	typ	max	
CSD Oscillator Circuit						
High level output voltage	V_{OH} (CSD)		2.7	3.0	3.3	V
Low level output voltage	V_{OL} (CSD)		0.8	1.0	1.2	V
Amplitude	V (CSD)		1.75	2.0	2.25	Vp-p
External capacitor charging current	ICHG1 (CSD)	VCHG1 = 2.0V	-17	-10	-4	μ A
External capacitor discharging current	ICHG2 (CSD)	VCHG2 = 2.0V	4	10	17	μ A
Oscillation frequency	f (CSD)	C = 0.22 μ F (design target value)		113.6		Hz
PWM Oscillator (PWM pin)						
High level output voltage	V_{OH} (PWM)		3.3	3.5	3.8	V
Low level output voltage	V_{OL} (PWM)		1.3	1.5	1.7	V
Amplitude	V (PWM)		1.78	2.0	2.22	Vp-p
Oscillation frequency	f (PWM)	C = 2200pF, R = 15k Ω (design target value)		17		kHz
Current Limiter Operation						
Limiter voltage	VRF		0.225	0.25	0.275	V
Thermal Shutdown Protection Operation						
Thermal shutdown protection operating temperature	TSD	* Design target value (junction temperature)	150	175		$^{\circ}$ C
Hysteresis width	Δ TSD	* Design target value (junction temperature)		35		$^{\circ}$ C
TH pin						
Protection start voltage	VTH		0.25	0.6	1.05	V
Hysteresis width	Δ VTH		0.2	0.4	0.6	V
HB pin						
Output ON resistance	R_{ON} (HB)	IHB = 10mA		15	30	Ω
Output leakage current	I_L (HB)	Power saving mode $V_{CC} = 15V$			10	μ A
Low Voltage Protection Circuit (detecting V_{CC} voltage)						
Operation voltage	VSD		7.0	8.0	9.0	V
Hysteresis width	Δ VSD		0.25	0.5	0.75	V
FG1 FG3 Pin						
Output ON resistance	R_{ON} (FG)	IFG = 5mA		40	60	Ω
Output leakage current	I_L (FG)	VFG = 18V			10	μ A
CTL Amplifier (drive mode)						
Input voltage range	V_{IN} (CTL)		0		VCC	V
High level input voltage	V_{IH} (CTL)	PWM ON duty 90%	5.1	5.4	5.7	V
Middle level input voltage	V_{IM} (CTL)	PWM ON duty 0%	1.8	2.1	2.4	V
CTL Amplifier (power saving mode)						
Low level input voltage	V_{IL1} (CTL)	Power saving mode		1.0	1.5	V
Hysteresis width	Δ CTL		0.15	0.5	0.85	V
Input current	I_{IH} (CTL)	CTL = 3.5V	10	18	26	μ A
F/R Pin						
High level input voltage	V_{IH} (FR)		3.0		VREG	V
Low level input voltage	V_{IL} (FR)		0		0.7	V
Input open voltage	V_{IO} (FR)			0	0.3	V
Hysteresis width	V_{IS} (FR)		0.21	0.31	0.41	V
High level input current	I_{IH} (FR)	VF/R = VREG	10	50	100	μ A
Low level input current	I_{IL} (FR)	VF/R = 0V	-10	0	+10	μ A

Continued on next page.

LV8136V

Continued from preceding page.

Parameter	Symbol	Conditions	Ratings			Unit
			min	typ	max	
FAULT Pin						
Drive stop voltage	VFOF		0		0.35	V
Drive start voltage	VFON		3.0		VREG	V
Input open voltage	V _{IO} (FLT)		4.6	VREG		V
High level input current	I _{IH} (FLT)	VFLT=VREG		0	10	μA
Low level input current	I _{IL} (FLT)	VFLT=0V	-250	-160	-70	μA
ADP1 Pin (drive phase adjustment)						
Minimum lead angle	Vadp01	ADP1 pin = 0V		0	2	Deg
Maximum lead angle	Vadp16	ADP1 pin = VREG	26	28		Deg
Current ratio with the ADP2 pin current	ADP	CTL = 3.75V, IADP1/IADP2	1.45	2	2.55	A/A
ADP2 Pin (drive phase adjustment)						
High level output voltage	VADP2H	CTL = 5.4V	1.95	2.5	3.05	V
Low level output voltage	VADP2L	CTL = 0V	0		0.51	V
DPL Pin (drive-phase-adjustment limit setting pin)						
Lead angle limit high level voltage	VDPLH		3.3	3.5	3.8	V
Lead angle limit low level voltage	VDPLL		1.3	1.5	1.7	V

* These are design target values and no measurements are made.

LV8136V

Package Dimensions

unit : mm (typ)
3191C

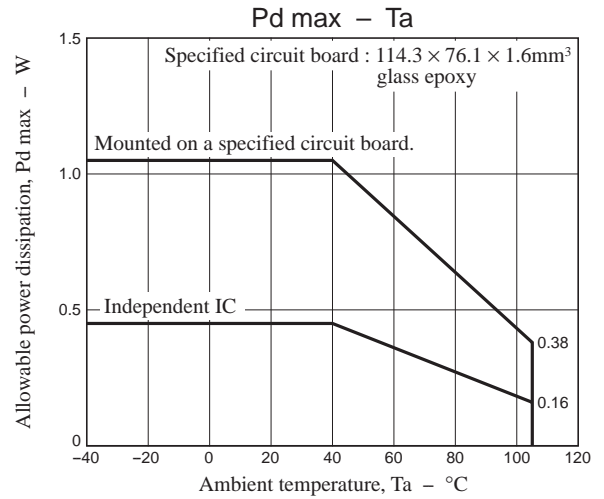
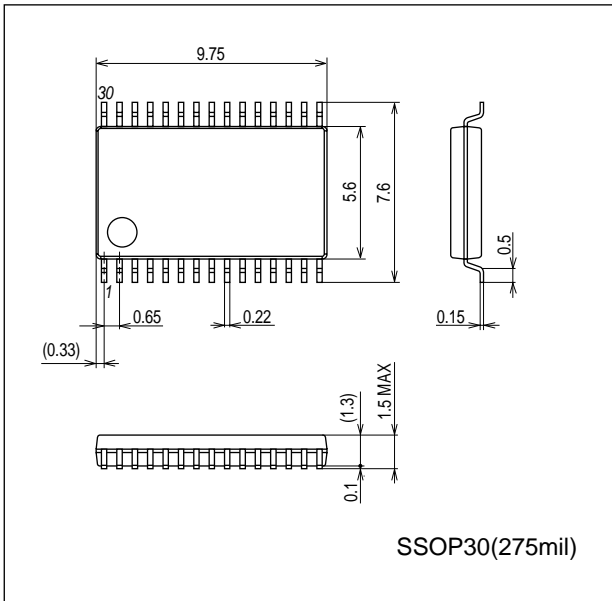

Pin Assignment

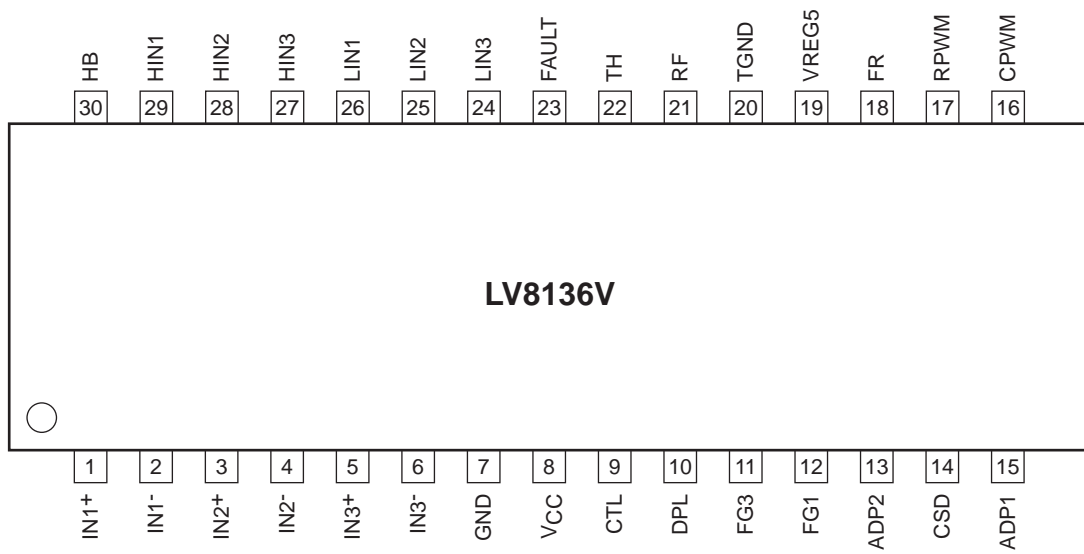

Top view

LV8136V

Sample Application Circuit 4 (Hall IC, FET)

Note: The Hall IC to be used must be of open collector or open drain type (no internal pull-up resistor connected to the output).

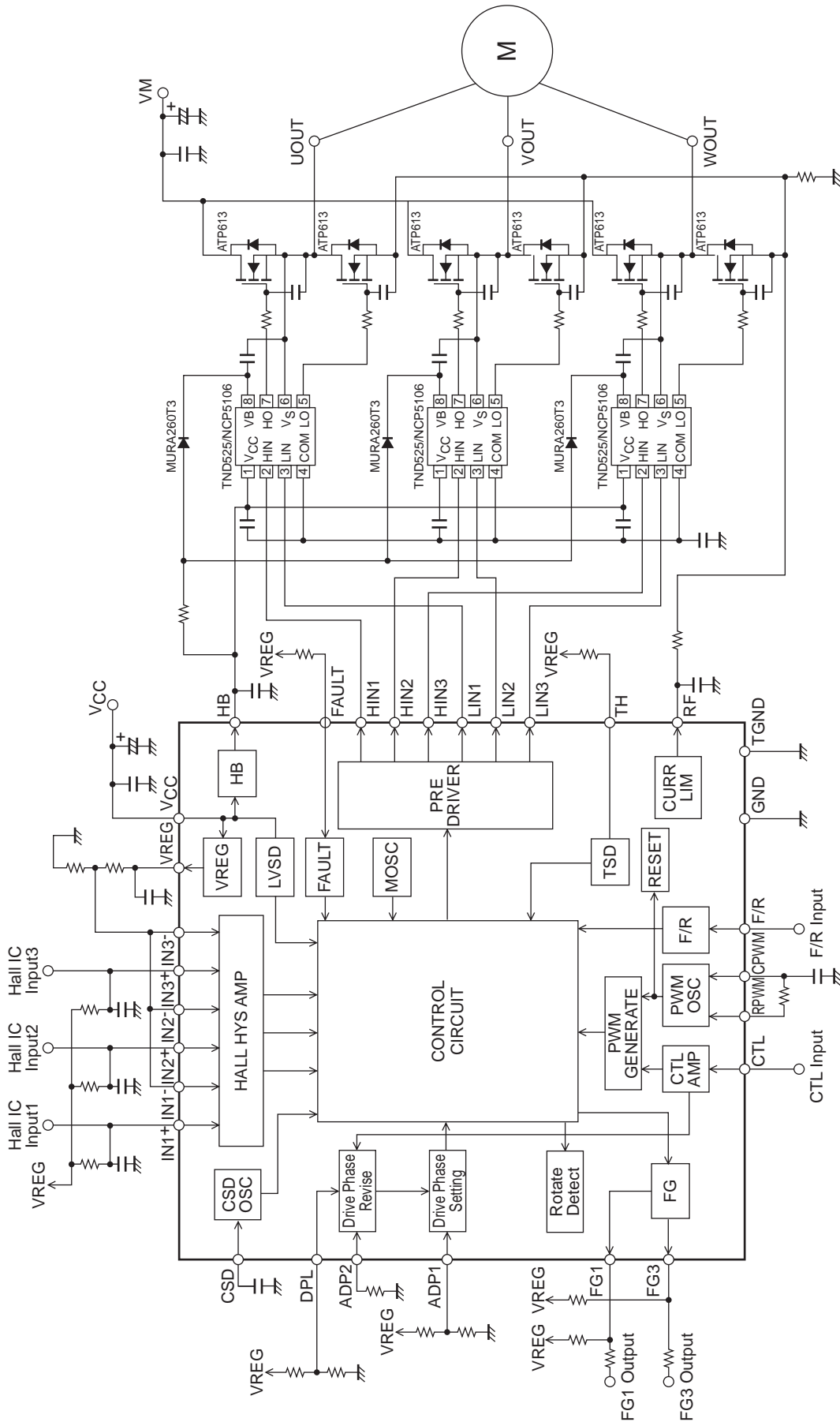

LV8136V

Pin Functions

Pin No.	Pin Name	Pin function	Equivalent Circuit
1 2 3 4 5 6	IN1 ⁺ IN1 ⁻ IN2 ⁺ IN2 ⁻ IN3 ⁺ IN3 ⁻	Hall signal input pins. The high state is when IN ⁺ is greater than IN ⁻ , and the low state is the reverse. An amplitude of at least 100mVp-p (differential) is desirable for the Hall signal inputs. If noise on the Hall signals is a problem, insert capacitors between IN ⁺ and IN ⁻ pins. If input is provided from a Hall IC, the common-mode input range can be expanded by biasing either + or -.	
7	GND	Ground pin of the control circuit block.	
8	VCC	Power supply pin for control. Insert a capacitor between this pin and ground to prevent the influence of noise, etc.	
9	CTL	Control input pin. When CTL pin voltage rises, the IC changes the output signal PWM duty to increase the torque output.	
10	DPL	Setting pin for drive phase adjustment limit. This pin is used to limit the lead angle of the drive phase. The lead angle is limited to zero degrees when the voltage is 1.5V or lower and the limit is released when the voltage is 3.5V or higher.	
11 12	FG3 FG1	FG3 : 3-Hall FG signal output pin. 8-pole motor outputs 12 FG pulses per one rotation. In power saving mode, high-level is output. FG1 : 1-Hall FG signal output pin. 8-pole motor outputs 4 pulses per one rotation. In power saving mode, high-level is output.	

Continued on next page.

LV8136V

Continued from preceding page.

Pin No.	Pin Name	Pin function	Equivalent Circuit
13	ADP2	Setting pin for phase drive correction. This pin sets the amount of correction made to the lead angle according to the CTL input. Insert a resistor between this pin and ground to adjust the amount of correction.	
14	CSD	Pin to set the operating time of the motor constraint protection circuit. Insert a capacitor between this pin and ground. This pin must be connected to ground if the constraint protection circuit is not used.	
15	ADP1	Drive phase adjustment pin. The drive phase can be advanced from 0 to 28 degrees during 150-degree current carrying drive. The lead angle becomes 0 degrees when 0V is input and 28 degrees when 5V is input.	
16	CPWM	Triangle wave oscillation pin for PWM generation. Insert a capacitor between this pin and ground and a resistor between this pin and RPWM for triangle wave oscillation.	
17	RPWM	Oscillation pin for PWM generation. Insert a resistor between this pin and CPWM.	

Continued on next page.

LV8136V

Continued from preceding page.

Pin No.	Pin Name	Pin function	Equivalent Circuit
18 20	FR TGND	FR Forward/reverse rotation setting pin. A low-level specifies forward rotation and a high-level specifies reverse rotation. This pin is held low when open. TGND Test pin. Connect this pin to ground.	
19	VREG5	5V regulator output pin (control circuit power supply). Insert a capacitor between this pin and ground for power stabilization. 0.1μF or so is desirable.	
21	RF	Output current detection pin. This pin is used to detect the voltage across the current detection resistor (Rf). The maximum output current is determined by the equation $I_{OUT} = 0.25V/R_f$.	
22	TH	Thermistor connection pin. The thermistor detects heat generated from HIC and turns off the drive output when an overheat condition occurs. If the pin voltage is 0.6V or lower, the drive output is turned off.	

Continued on next page.

LV8136V

Continued from preceding page.

Pin No.	Pin Name	Pin function	Equivalent Circuit
23	FAULT	HIC protection signal input pin. This pin accepts an error mode detection signal generated by the HIC side. A low-level indicates that an error mode is detected and turns off the drive output.	
24 25 26 27 28 29	LIN3 LIN2 LIN1 HIN3 HIN2 HIN1	LIN1, LIN2, and LIN3 : L-side output pins. Generate 0 to VREG5 push-pull outputs. HIN1, HIN2, and HIN3 : H-side output pins. Generate 0 to VREG5 push-pull outputs.	
30	HB	Hall bias HIC power supply pin. Insert a capacitor between this pin and ground. This pin is set to high-impedance state in power saving mode. By supplying Hall bias and HIC power using this pin, the power consumption by Hall bias and HIC in power saving mode can be reduced to zero.	

LV8136V

Timing Chart (IN = "H" indicates the state in which IN+ is greater than IN-.)

(1) F/R pin = L

Normal hall input LA=0

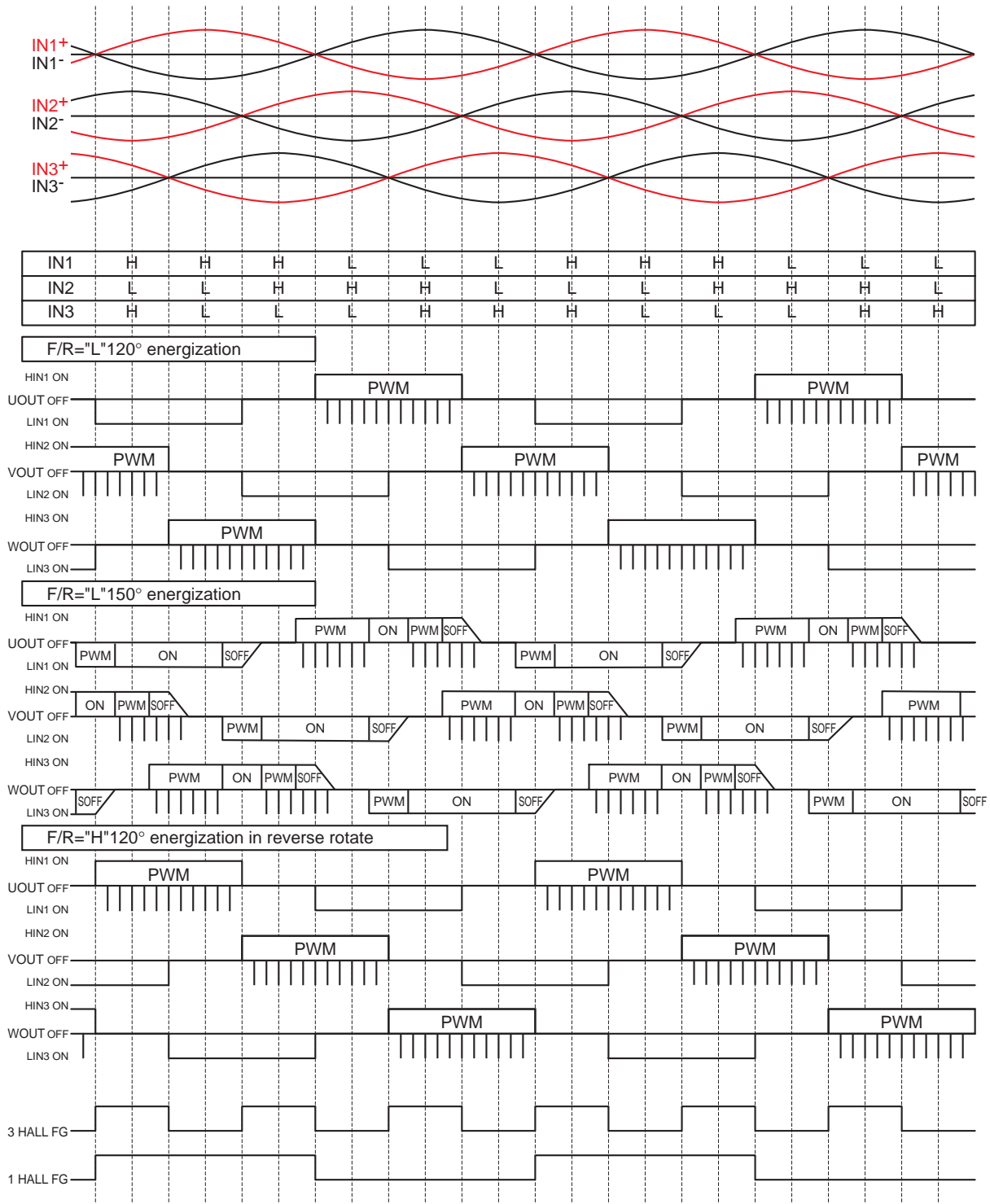

The energization is switched to 120° when 3 Hall FG frequency is 6.1Hz (TYP) or lower
 A direction of rotation is detected from Hall signal according to F/R pin input
 If the motor rotates in reverse against F/R pin input, 120° energization is maintained forcibly.

LV8136V

(2) F/R pin = H

Reverse hall input LA=0

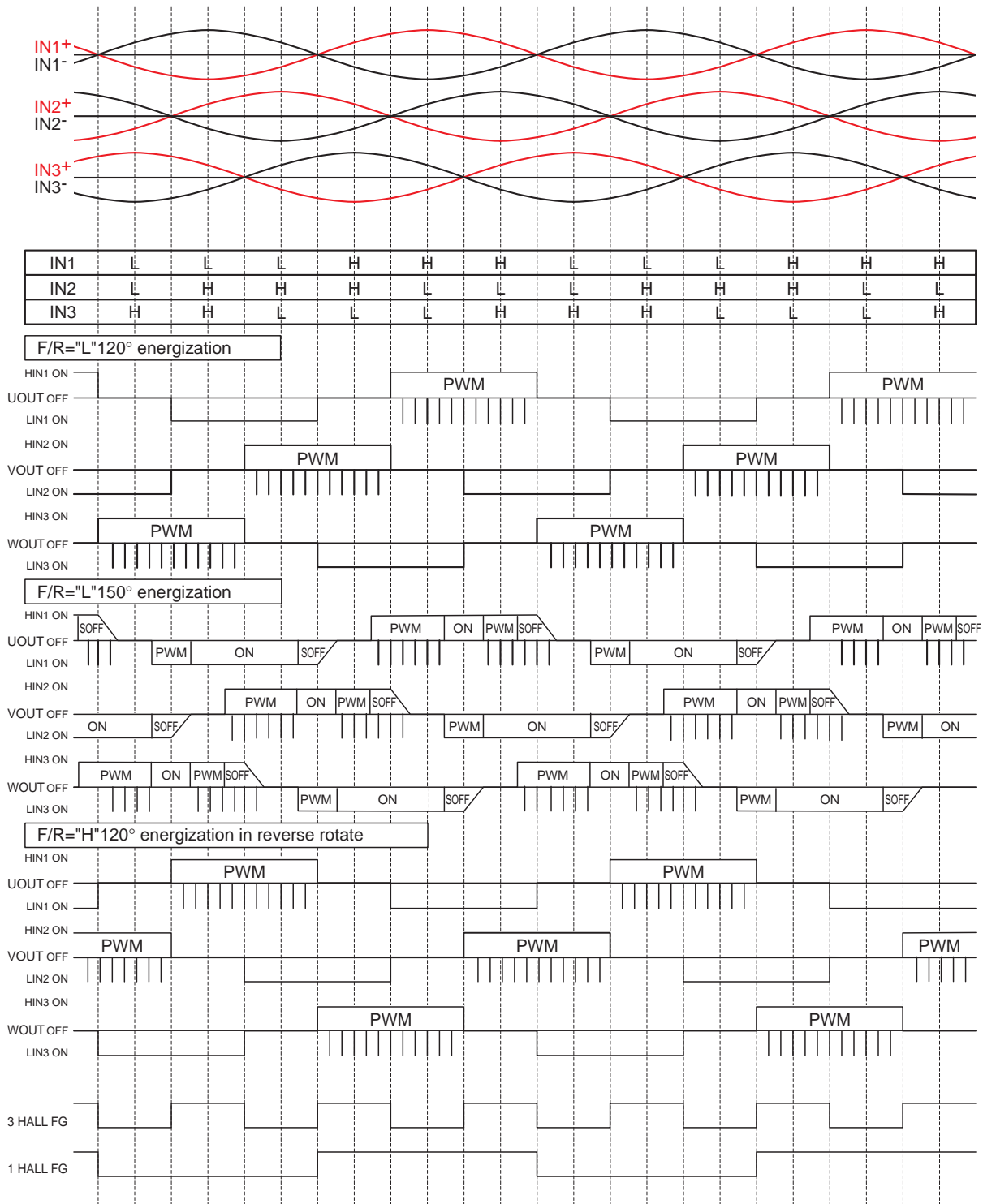

The energization is switched to 120° when 3 Hall FG frequency is 6.1Hz (TYP) or lower
 A direction of rotation is detected from Hall signal according to F/R pin input
 If the motor rotates in reverse against F/R pin input, 120° energization is maintained forcibly.

Functional Description

- Basic operation of 120-degree \leftrightarrow 150-degree current-carrying switching
 At startup, this IC starts at 120-degree current-carrying. The current-carrying is switched to 150 degrees when the 3-Hall FG frequency is 6.1Hz (typ) or above and the rising edge of the IN2 signal has been detected twice in succession.
- Concerning the Hall signal input sequence
 This IC controls the motor rotation direction commands and Hall signal input sequence in order to set the lead angle. If the motor rotation direction commands and Hall signal input sequence do not conform to what is shown on the timing chart, the motor is driven by 120-degree current-carrying.

Example 1 : When the Hall signal has been input with the following logic

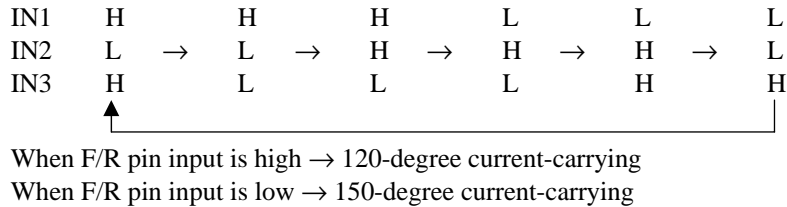

Example 2 : When the Hall signal has been input with the following logic

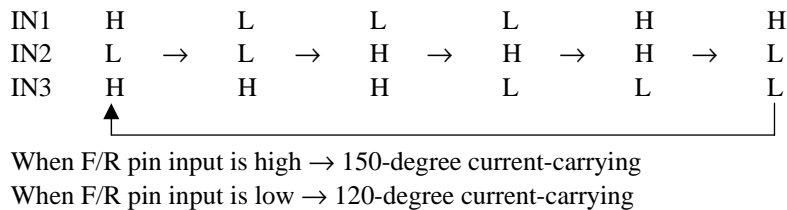

- CTL pin input

a) Power-saving mode $V_{CTL} < V_{IL}$ (1.0V : typ)

When the CTL pin voltage is lower than V_{IL} (1.0V : typ), the IC enters the power-saving mode, and the following are set :

- L_{IN1} to L_{IN3} and H_{IN1} to H_{IN3} outputs all set to low
- $I_{CC} = 0$, HB pin = OFF

The power consumption of the IC can now be set to 0, and the power consumption of the Hall element connected to the HB pin and the output block can also be set to 0.

b) Standby mode $V_{IL} < V_{CTL} < V_{IM}$ (2.1V : typ)

When the CTL pin voltage is $V_{IL} < V_{CTL} < V_{IM}$, the IC enters the standby mode. Low is output for the U_{IN1} to U_{IN3} outputs and bootstrap charge pulses (2 μ s pulse width: design target) are output to the L_{IN1} to L_{IN3} outputs to prepare for drive start.

c) Drive mode $V_{IM} < V_{CTL} < V_{IH}$ (5.4V : typ)

When the CTL pin voltage is $V_{IM} < V_{CTL} < V_{IH}$, the IC enters the drive mode, and the motor is driven at the PWM duty ratio corresponding to V_{CTL} . When V_{CTL} is increased, the PWM duty ratio increases, and the maximum duty ratio (*90% : typ) is reached at V_{IH} .

* When the PWM oscillation frequency setting is 17kHz.

d) Test mode $8V < V_{CTL} < V_{CTL\ max}$ (design target)

When the CTL pin voltage is 8V or higher, the IC enters the test mode, and the motor is driven at the 120-degree current-carrying and maximum duty ratio.

- The CTL pin is pulled down by 190k Ω : typ inside the IC. Caution is required when the control input voltage input is subjected to resistance division, for example.

- Bootstrap capacitor initial charging mode

When the mode is switched from the power-saving mode to the standby mode and then to the drive mode, the IC enters the bootstrap capacitor charging mode (UH, VH, WH pins = L UL, VL, WL pins = H 3.84ms typ) in order to charge the bootstrap capacitor.

• Drive phase adjustment

During 150-degree current-carrying drive, current-carrying is started from the phase that is 15 degrees ahead of the 120-degree current-carrying. From this state, any lead angle from 0 to 28 degrees can be set using the ADP1 pin voltage (lead angle control). This setting can be adjusted in 16 steps (in 1.875-degree increments) from 0 to 28 degrees using the ADP1 pin voltage, and it is updated every Hall signal cycle (it is sampled at the rising edge of the IN3 input and updated at its falling edge).

A number of lead angle adjustments proportionate to the CTL pin voltage can be undertaken by adjusting the resistance levels of resistors connected to the ADP1 pin, ADP2 pin and DPL pin. When these pins are not going to be used, reference must be made to section 4.5, and the pins must not be used in the open status. Furthermore, a resistance of 47kΩ or more must be used for the resistor (RADP2) that is connected to the ADP2 pin.

1. The slopes of V_{CTL} and V_{ADP1} can be adjusted by setting the resistance level of the resistor (RADP1) connected to ADP1 (pin 15).

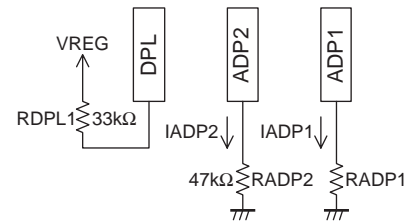
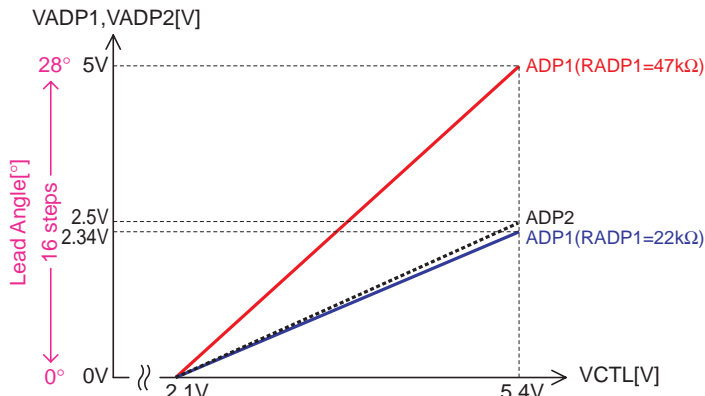

$$\begin{aligned} V_{ADP2} &= (V_{CTL} - 2.1) \times (2.5/3.3) \\ I_{ADP2} &= V_{ADP2} / RADP2 \\ I_{ADP1} &= 2 \times I_{ADP2} \\ V_{ADP1} &= I_{ADP1} \times RADP1 \end{aligned}$$

2. The ADP2 pin rise can be halted (a limit on the lead angle adjustment can be set by means of the CTL voltage) by setting DPL (pin 10).

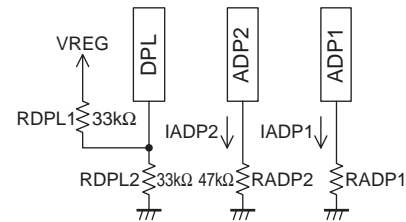
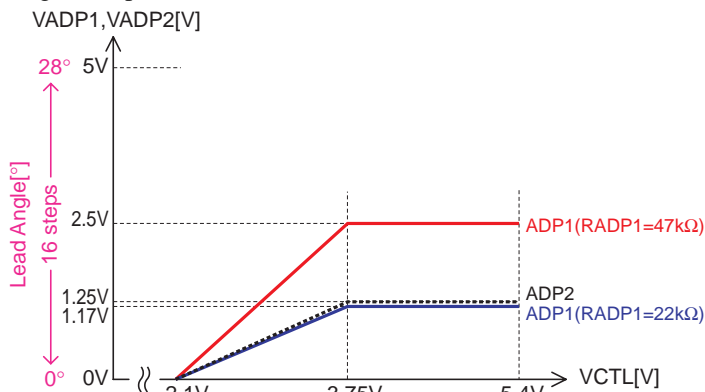

$$\begin{aligned} V_{ADP2} &= (V_{CTL} - 2.1) \times (2.5/3.3) \\ I_{ADP2} &= V_{ADP2} / RADP2 \\ I_{ADP1} &= 2 \times I_{ADP2} \\ V_{ADP1} &= I_{ADP1} \times RADP1 \\ DPL_{LIM} &= V_{DPL} \times 1.5 \end{aligned}$$

3. The offset and slope can be adjusted as desired by setting RADP1 and RADP12 of ADP1 (pin 15). (It is also possible to set a limit on the lead angle adjustment by means of the CTL voltage by setting DPL.)

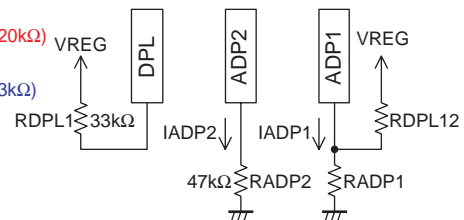
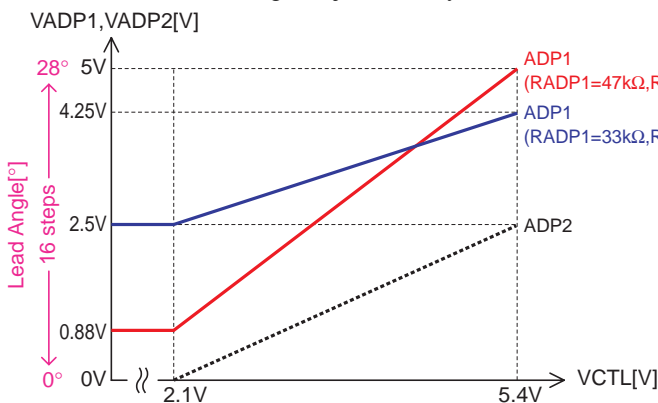

$$\begin{aligned} V_{ADP2} &= (V_{CTL} - 2.1) \times (2.5/3.3) \\ I_{ADP2} &= V_{ADP2} / RADP2 \\ I_{ADP1} &= 2 \times I_{ADP2} \\ V_{ADP1} &= ((RADP1 \times RADP12) / (RADP1 + RADP12)) \times I_{ADP1} \\ &\quad + (RADP1 / (RADP1 + RADP12)) \times V_{REG} \end{aligned}$$

4. When the lead angle is not adjusted

ADP1 pin: shorted to ground; ADP2 pin and DPL pin: pulled down to ground using the resistors

5. When the lead angle is not adjusted by means of the CTL pin voltage (for use with a fixed lead angle)

ADP1 pin: lead angle setting by resistance division from VREG; ADP2 pin and DPL pin: pulled down to ground by the resistors

Description of LV8136V

1. Current Limiter Circuit

The current limiter circuit limits the output current peak value to a level determined by the equation $I = V_{RF}/R_f$ (where $V_{RF} = 0.25V$ typ, R_f is the value of the current detection resistor). The current limiter operates by reducing the output on duty to suppress the current.

The current limiter circuit detects the reverse recovery current of the diode due to PWM operation. To assure that the current limiting function does not malfunction, its operation has a delay of approx. $1\mu s$. If the motor coils have a low resistance or a low inductance, current fluctuation at startup (when there is no back electromotive force in the motor) will be rapid. The delay in this circuit means that at such times the current limiter circuit may operate at a point well above the set current. Application must take this increase in the current due to the delay into account when the current limiter value is set.

2. Power Saving Circuit (CTL pin)

This IC goes into the power saving mode that stops operation of all the circuits to reduce the power consumption. If the HB pin is used for the Hall element bias and the output block, the current consumption in the power-saving mode is zero.

3. Hall Input Signal

Signals with an amplitude in excess of the hysteresis is required for the Hall inputs. However, considering the influence of noise and phase displacement, an amplitude of over 100mV is desirable.

If noise disrupts the output waveform (at phase change), this must be prevented by inserting capacitors or other devices across the Hall inputs. The constraint protection circuit uses the Hall inputs to discriminate the motor constraint state. Although the circuit is designed to tolerate a certain amount of noise, care is required.

If all three phases of the Hall input signal go to the same input state (HHH or LLL), the outputs are all set to the off state.

If the outputs from a Hall IC are used, fixing one side of the inputs (either the + or -side) at a voltage within the common-mode input voltage range (0.3V to VREG-1.7V) allows the other input side to be used as an input over the 0V to VREG range.

4. Constraint Protection Circuit

This IC goes into the power saving mode that stops operation of all the circuits to reduce the power consumption. If the HB pin is used for the Hall element bias and the output block, the current consumption in the power-saving mode is zero.

This IC provides an on-chip constraint protection circuit to protect the IC itself and the motor when the motor is constrained.

If the Hall input signals do not change for over a fixed period when the motor is in operation, this circuit operates. Also, the upper-side output transistor is turned off while the constraint protection circuit is operating. This time is determined by the capacitance of the capacitor connected to the CSD pin.

$$\text{Set time (in seconds)} \approx 90 \times C (\mu F)$$

If a $0.022\mu F$ capacitor is used, the protection time will be about 2.0 seconds.

The set time must be selected to have an adequate margin with respect to the motor startup time

Conditions to clear the constraint protection state :

- CTL pin when a low-level voltage is input → Release protection and reset count
- When TSD protection is detected → Stop count

5. Power Supply Stabilization

Since this IC adopts a switching drive technique, the power-supply line level can be disrupted easily. Thus capacitors large enough to stabilize the power supply voltage must be inserted between the V_{CC} pins and ground. If the electrolytic capacitors cannot be connected close to their corresponding pins, ceramic capacitors of about $0.1\mu F$ must be connected near these pins.

If diodes are inserted in the power-supply line to prevent destruction of the device when the power supply is connected with reverse polarity, the power supply line levels will be even more easily disrupted, and even larger capacitors must be used.

6. VREG Stabilization

A capacitor of at least 0.1 μ F must be used to stabilize the VREG voltage, which is the control circuit power supply. The ground lead of that capacitor must be located as close as possible to the control system ground (SGND) of the IC.

7. Forward/Reverse Switching (F/R pin)

Switching between forward rotation and reverse rotation must not be undertaken while the motor is running.

8. TH Pin

The TH pin must normally be pulled up to the 5V regulator for use. When it has been set to low, the outputs of L_{IN}1, L_{IN}2 and L_{IN}3 as well as H_{IN}1, H_{IN}2 and H_{IN}3 are low.

9. FAULT Pin

The FAULT pin must normally be pulled up to the 5V regulator for use. When it has been set to low, the outputs of L_{IN}1, L_{IN}2 and L_{IN}3 as well as H_{IN}1, H_{IN}2 and H_{IN}3 are low.

10. PWM Frequency Setting

$$f_{CPWM} \approx 1 / (1.78CR)$$



Components with good temperature characteristics must be used.

An oscillation frequency of about 17kHz is obtained when a 2200pF capacitor and 15k Ω resistor are used. If the PWM frequency is too low, switching noise will be heard from the motor; conversely, if it is too high, the output power loss will increase. For this reason, a frequency between 15kHz and 30kHz or so is desirable. The capacitor ground must be connected as close as possible to the control system ground (SGND pin) of the IC to minimize the effects of the outputs.

ON Semiconductor and the ON logo are registered trademarks of Semiconductor Components Industries, LLC (SCILLC). SCILLC owns the rights to a number of patents, trademarks, copyrights, trade secrets, and other intellectual property. A listing of SCILLC's product/patent coverage may be accessed at www.onsemi.com/site/pdf/Patent-Marking.pdf. SCILLC reserves the right to make changes without further notice to any products herein. SCILLC makes no warranty, representation or guarantee regarding the suitability of its products for any particular purpose, nor does SCILLC assume any liability arising out of the application or use of any product or circuit, and specifically disclaims any and all liability, including without limitation special, consequential or incidental damages. "Typical" parameters which may be provided in SCILLC data sheets and/or specifications can and do vary in different applications and actual performance may vary over time. All operating parameters, including "Typicals" must be validated for each customer application by customer's technical experts. SCILLC does not convey any license under its patent rights nor the rights of others. SCILLC products are not designed, intended, or authorized for use as components in systems intended for surgical implant into the body, or other applications intended to support or sustain life, or for any other application in which the failure of the SCILLC product could create a situation where personal injury or death may occur. Should Buyer purchase or use SCILLC products for any such unintended or unauthorized application, Buyer shall indemnify and hold SCILLC and its officers, employees, subsidiaries, affiliates, and distributors harmless against all claims, costs, damages, and expenses, and reasonable attorney fees arising out of, directly or indirectly, any claim of personal injury or death associated with such unintended or unauthorized use, even if such claim alleges that SCILLC was negligent regarding the design or manufacture of the part. SCILLC is an Equal Opportunity/Affirmative Action Employer. This literature is subject to all applicable copyright laws and is not for resale in any manner.

Looking for pricing, stock, or lifecycle information?

Click below to explore more details on WIN SOURCE:

-  [View LV8136V-TLM-H on WIN SOURCE](#)
-  [ON Semiconductor](#) Information

Optimize Your Supply Chain with WIN SOURCE Solutions

-  Global Sourcing Solution
-  Obsolete Management
-  Cost Control Management
-  Shortage Management
-  Alternative Solution
-  Excess Inventory Management