



ON Semiconductor®

<http://onsemi.com>

# LV8019LP

## Bi-CMOS IC Forward/Reverse Motor Driver

### Overview

The LV8019LP is a forward/reverse motor driver.

### Features

- One H-bridge driver channel
- Provides a constant current output
- Built-in thermal shutdown circuit

### Specifications

**Maximum Ratings** at  $T_a = 25^\circ\text{C}$  and  $SGND = PGND = 0V$

Parameter	Symbol	Conditions	Ratings	Unit
Output block supply voltage	$V_M$ max		-0.5 to 8.4	V
Control block supply voltage	$V_{CC}$ max		-0.5 to 7.0	V
Constant current output block supply voltage	$V_{RG}$ max		-0.5 to 6.0	V
Maximum output current	$I_O$ max		1.2	A
	$I_O$ peak1	$t \leq 200\text{ms}$ , $f = 2\text{Hz}$	3	A
	$I_O$ peak2	$t \leq 10\text{ms}$ , $f = 2\text{Hz}$	5	A
Input signal voltage	$V_{IN}$ max		-0.5 to $V_{CC}+0.5$	A
Allowable power dissipation	$P_d$ max1	Independent IC	0.2	W
	$P_d$ max2	When mounted on a circuit board *1	1.05	W
Operating temperature	$T_{opr}$		-30 to +85	$^\circ\text{C}$
Storage temperature	$T_{stg}$		-55 to +150	$^\circ\text{C}$

\* : Specified substrate :  $40 \times 50 \times 0.8\text{mm}^3$ , glass epoxy four-layer (2S2P) board

Stresses exceeding Maximum Ratings may damage the device. Maximum Ratings are stress ratings only. Functional operation above the Recommended Operating Conditions is not implied. Extended exposure to stresses above the Recommended Operating Conditions may affect device reliability.

# LV8019LP

## Recommended Operating Conditions at $T_a = 25^\circ\text{C}$ and $\text{SGND} = \text{PGND} = 0\text{V}$

Parameter	Symbol	Conditions	Ratings	Unit
Output block supply voltage	$V_M$		3.0 to 7.4	V
Control block supply voltage	$V_{CC}$		2.7 to 6.0	V
Constant current output block supply voltage	$V_{RGIN}$		1.5 to $V_{CC}$	V
Input signal voltage	$V_{IN}$		0 to $V_{CC}$	V
Maximum input signal frequency	$f_{max}$	Duty = 50%	100	kHz

## Electrical Characteristics $T_a = 25^\circ\text{C}$ , $V_{CC} = V_M = 5\text{V}$ , and $\text{SGND} = \text{PGND} = 0\text{V}$ unless otherwise specified.

Parameter	Symbol	Conditions	Ratings			Unit
			min	typ	max	
Standby mode output block current consumption	$I_{MO}$	$\text{EN} = 0\text{V}$ , $\text{IN1} = \text{IN2} = \text{ICTRL} = 0\text{V}$			1.0	$\mu\text{A}$
Control block current consumption	Standby mode	$\text{EN} = 0\text{V}$ , $\text{IN1} = \text{IN2} = \text{ICTRL} = 0\text{V}$		0	1.0	$\mu\text{A}$
	Operation mode	$\text{EN} = 5\text{V}$		0.8	1.3	mA
High-level input voltage	$V_{INH}$	$\text{IN}^*$	2.5		$V_{CC}$	V
Low-level input voltage	$V_{INL}$	$\text{IN}^*$	0		0.8	V
High-level input current	$I_{INH}$	$\text{IN}^*$			1.0	$\mu\text{A}$
Low-level input current	$I_{INL}$	$\text{IN}^*$	-1.0			$\mu\text{A}$
High-level EN pin current	$I_{ENH}$	EN	15	25	35	$\mu\text{A}$
Low-level EN pin current	$I_{ENL}$	EN			1.0	$\mu\text{A}$
Output on resistance	1	$R_{ON1}$		0.30	0.40	$\Omega$
	2	$R_{ON2}$		0.45	0.60	$\Omega$
ISET setting resistance	RSET	Between ISET pin and SGND	80			$\Omega$
ISET pin voltage	$V_{ISET}$	$R_{SET} > 80\Omega$	0.90	1.05	1.20	V
CC pin output saturation voltage	$V_{CSAT}$	$R_{SET} = 150\Omega$ *1			1.5	V
CC pin output leakage current	$I_{CONL}$	$\text{CTRL} = 0\text{V}$			1.0	$\mu\text{A}$
Low voltage shutdown operation voltage	$V_{LVD}$	$V_{CC}$ pin voltage detection	2.10	2.35	2.60	V
High-level output turn-on time	TOH	The transition from 10% to 90% of the output amplitude *2		0.1	1.0	$\mu\text{s}$
Low-level output turn-on time	TOL	The transition from 90% to 10% of the output amplitude *2		0.2	2.0	$\mu\text{s}$
Thermal shutdown temperature	TSD	*2	150	180		$^\circ\text{C}$
Thermal shutdown hysteresis	$\Delta\text{TSD}$	*2		40		$^\circ\text{C}$

\*1 : Voltage between CC pin and ISET pin

\*2 : Design guarantee: These characteristics are not measured.

# LV8019LP

## Package Dimensions

unit : mm (typ)

3321

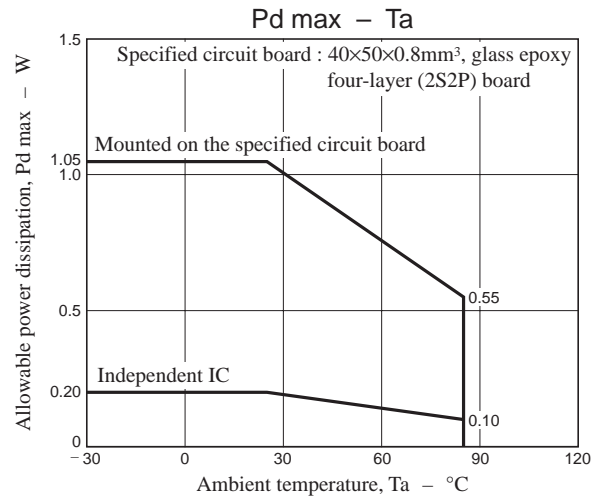
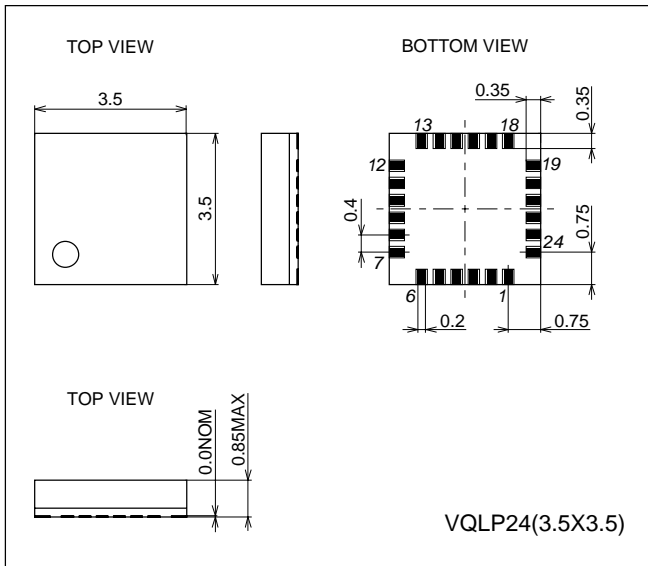

## Pin Assignment

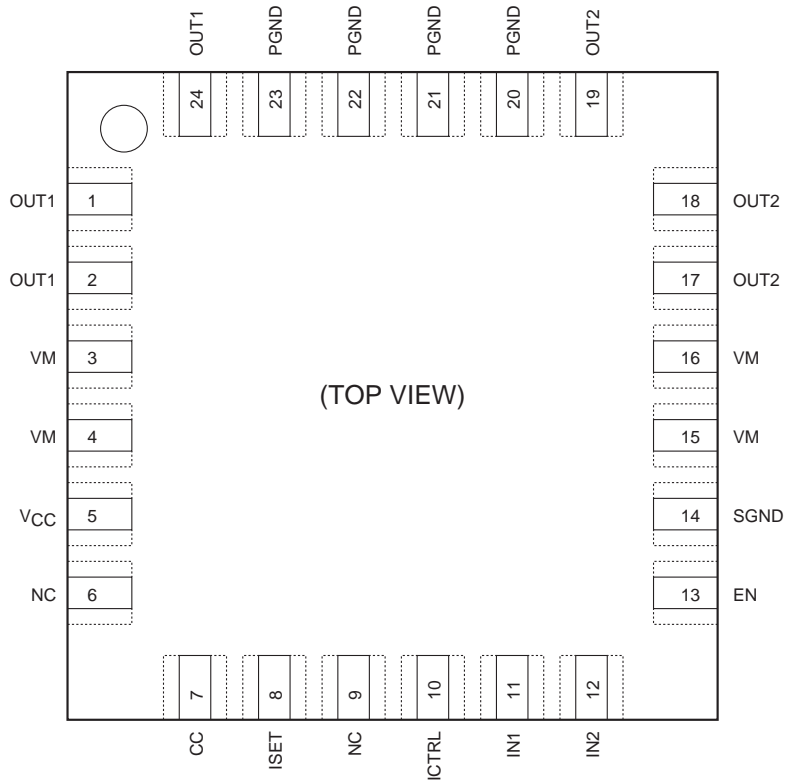

## Constant current output

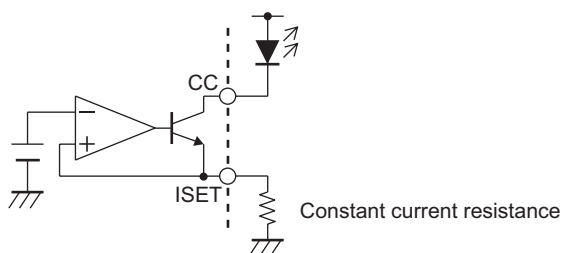

# LV8019LP

## Block Diagram

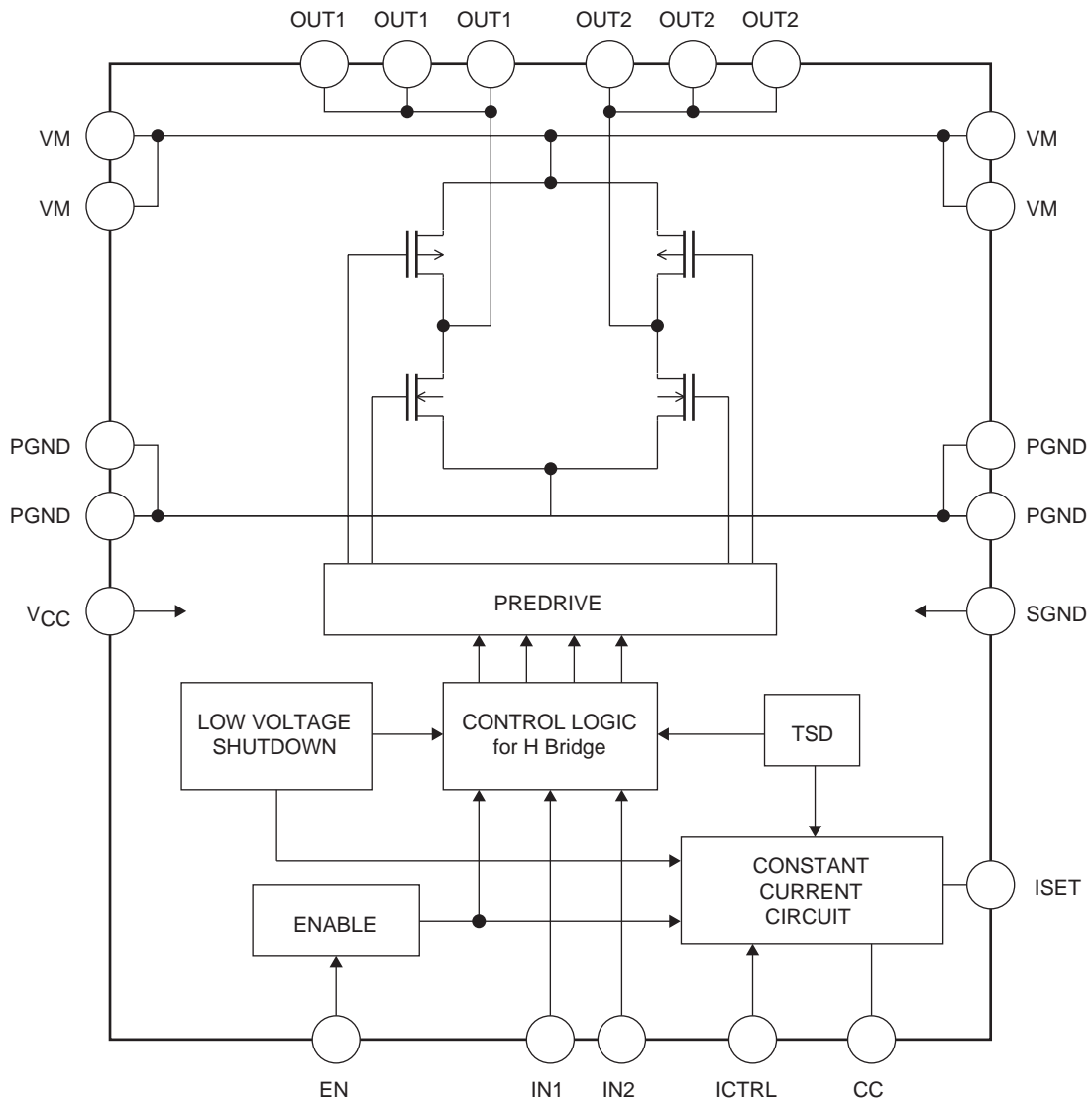

## Truth Table

EN	IN1	IN2	CTRL	OUT1	OUT2	CC	Mode
H	H	H	X	L	L	X	Break
H	H	L	X	H	L	X	Forward
H	L	H	X	L	H	X	Reverse
H	L	L	X	Z	Z	X	Standby
L	X	X	X	L	L	L	Standby
H	X	X	L	X	X	Z	Constant current output off
H	X	X	H	X	X	ON	Constant current output on

H : High level  
 L : Low level  
 Z : Hi-impedance  
 X : Don't care

# LV8019LP

## Pin Functions

Pin No.	Pin	Description	Equivalent circuit
11 12	IN1 IN2	Logic input 1 Logic input 2 The output is set by the combination of the input 1 and 2 states. See the truth table for details.	
10	ICTRL	Controls the output on/off state of the constant current block.	
13	EN	EN pin Controls the on/off state of the H-bridge output (OUT1 and OUT2) and the constant current output. See the truth table for details.	
1, 2, 24, 17, 18, 19	OUT1 OUT2	Output 1 Output 2 The source side is a p-channel transistor and sink side is an n-channel transistor.	
7 8	CC ISET	Constant current output Constant current setting The output current (CC) is set by connecting a resistor between the ISET pin and ground.	
5	VCC	Signal system power supply	
3, 4, 15, 16	VM	Power system power supply	
14	SGND	Signal system ground	
21, 22, 23	PGND	Power system ground	

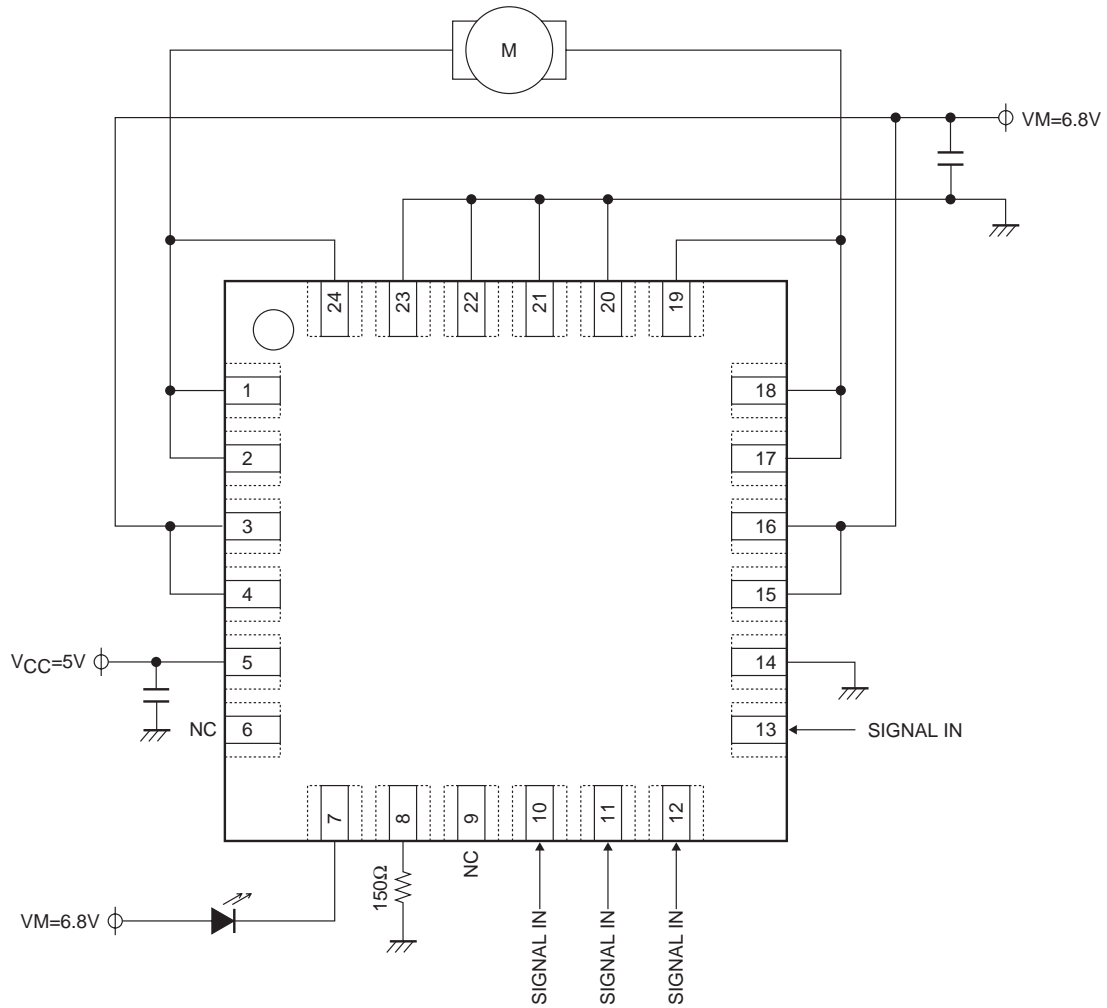

## Application Example



ON Semiconductor and the ON logo are registered trademarks of Semiconductor Components Industries, LLC (SCILLC). SCILLC owns the rights to a number of patents, trademarks, copyrights, trade secrets, and other intellectual property. A listing of SCILLC's product/patent coverage may be accessed at [www.onsemi.com/site/pdf/Patent-Marking.pdf](http://www.onsemi.com/site/pdf/Patent-Marking.pdf). SCILLC reserves the right to make changes without further notice to any products herein. SCILLC makes no warranty, representation or guarantee regarding the suitability of its products for any particular purpose, nor does SCILLC assume any liability arising out of the application or use of any product or circuit, and specifically disclaims any and all liability, including without limitation special, consequential or incidental damages. "Typical" parameters which may be provided in SCILLC data sheets and/or specifications can and do vary in different applications and actual performance may vary over time. All operating parameters, including "Typicals" must be validated for each customer application by customer's technical experts. SCILLC does not convey any license under its patent rights nor the rights of others. SCILLC products are not designed, intended, or authorized for use as components in systems intended for surgical implant into the body, or other applications intended to support or sustain life, or for any other application in which the failure of the SCILLC product could create a situation where personal injury or death may occur. Should Buyer purchase or use SCILLC products for any such unintended or unauthorized application, Buyer shall indemnify and hold SCILLC and its officers, employees, subsidiaries, affiliates, and distributors harmless against all claims, costs, damages, and expenses, and reasonable attorney fees arising out of, directly or indirectly, any claim of personal injury or death associated with such unintended or unauthorized use, even if such claim alleges that SCILLC was negligent regarding the design or manufacture of the part. SCILLC is an Equal Opportunity/Affirmative Action Employer. This literature is subject to all applicable copyright laws and is not for resale in any manner.

## Looking for pricing, stock, or lifecycle information?

Click below to explore more details on WIN SOURCE:

-  [View LV8019LP-MPB-E on WIN SOURCE](#)
-  [ON Semiconductor](#) Information

## Optimize Your Supply Chain with WIN SOURCE Solutions

-  Global Sourcing Solution
-  Obsolete Management
-  Cost Control Management
-  Shortage Management
-  Alternative Solution
-  Excess Inventory Management