

LV5012MD

Specifications

Maximum Ratings at Ta = 25°C

Parameter	Symbol	Conditions	Ratings	unit
High Voltage Input	HV_abs		-0.3 to 500	V
VIN pin	VINmax		-0.3 to 40	V
ENB, CS, ACS, REF_OUT, ALC_C, REF_IN			-0.3 to 7	V
OUT Pin	Vout_abs		-0.3 to 40	V
DML Pin OFF	VDL_OFF_abs	ACS=2.0V	500	V
DML Pin ON	VDL_ON_abs	ACS=0.7V, TRC=1.0V	55	V
Allowable power dissipation	Pd max	With specified board *1	0.95	W
Junction temperature	Tj		150	°C
Operating Junction temperature	Topj		-30 to +125	°C
Storage temperature	Tstg		-40 to +150	°C

*1: Specified board = 64mm×24mm×1.2mm, glass epoxy board

Caution 1) Absolute maximum ratings represent the values which cannot be exceeded for any length of time.

Caution 2) Even when the device is used within the range of absolute maximum ratings, as a result of continuous usage under high temperature, high current, high voltage, or drastic temperature change, the reliability of the IC may be degraded. Please contact us for the further details.

Stresses exceeding Maximum Ratings may damage the device. Maximum Ratings are stress ratings only. Functional operation above the Recommended Operating Conditions is not implied. Extended exposure to stresses above the Recommended Operating Conditions may affect device reliability.

Recommended Operating Conditions at Ta = 25°C

Parameter	Symbol	Conditions	Ratings	unit
Input voltage	VIN		8.5 to 24	V

Electrical Characteristics at Ta = 25°C, VIN = 12V, unless otherwise specified.

Parameter	Symbol	Conditions	Ratings			unit
			min	typ	max	
◀ Reference Voltage block ▶						
Built-in Reference Voltage	VREF			0.45		V
FET Turn-Off CS Voltage	VCS	ACS=2.0V REF_IN=3V, ALC_C=0V		0.45		V
VIN Regulation of CS Voltage	VCS_LN	VIN=8.5 to 24V, REF_IN=3V ACS=2.0V, ALC_C=0V		±0.5		%
REF_IN Input Range	REFIN_RNG		0		3.2	V
Minimum ALC_C Voltage	MIN_ALC_C			0.5		V
TRC pin voltage of operation start	TRC_STR			0.1		V
TRC pin voltage of operation stop	TRC_STP			0.05		V
◀ Under Voltage Lockout ▶						
Operation Start Input Voltage	UVLOON		8	9	10	V
Operation Stop Input Voltage	UVLOFF		6.3	7.3	8.3	V
Hysteresis Voltage	UVLOH			1.7		V
◀ Oscillation ▶						
Frequency	FOSC		61	70	79	kHz
Maximum Duty	MAXDuty			70		%
◀ Comparator ▶						
Input current	IIOCS	CS=0V		160		nA
Duty ON detection voltage	VDTYON	CS=0V, REF_IN=3V		1.7		V
Duty OFF detection voltage	VDTYOFF	CS=0V, REF_IN=3V		1.3		V

LV5012MD

◀ Thermal protection Circuit ▶						
1 st stage thermal protection	OTP	*Design guarantee		140		°C
1 st stage hysteresis [1 st stage to normal operation]	ΔOTP	*Design guarantee		12		°C
Reference voltage at 1 st stage	REFOTP	*Design guarantee		0.1		V
Thermal shutdown Temperature	TSD	*Design guarantee		155		°C
Thermal shutdown hysteresis	ΔTSD	*Design guarantee		12		°C
◀ Drive Circuit ▶						
OUT sink current	IOI	VIN=12V,CS=3V, OUT=2V	500	1000		mA
OUT source current1 (First step driving current)	IOO1	VIN=12V,CS=0V, OUT=6V		50		mA
OUT source current2 (Second step driving current)	IOO2	VIN=12V,CS=0V, OUT=6V		200		mA
◀ Switching Stop Function ▶						
Switching stop ENB Voltage	ENBSP		1.9	2.0	2.1	V
Switching start ENB Voltage	ENBST		1.7	1.8	1.9	V
ENB Hysteresis Voltage	ENBHYS			0.2		V
◀ TRIAC Stabilization Circuit ▶						
Threshold of DML Load (Threshold of Bleeder)	VACS	Load Operation of the DML pin is started, when ACS pin is less than this value.		0.85		V
DML Load current	IDML	DML=40V, ACS=0.7V	20			mA
◀ Reference Out Circuit ▶						
REF_OUT Voltage	REF_OUT	VIN=12V, IREF_OUT=0.5mA	2.8	3.0	3.2	V
REF_OUT Load	IREF_OUT	VIN=12V			1	mA
◀ Startup circuit ▶						
Startup OUTPUT Voltage	VIN_OUT	ACS=2.0V,	11	12	13	V
Static startup current	IHV	ACS=2.0V, OUT=OPEN, CS=0.6V		1		mA
Leak current of Startup circuit	IHV2	HV=100V, VIN=15V		20		μA
◀ VIN current ▶						
UVLO mode VIN current	ICCOFF	VIN=7V		100		μA
LOW TRIAC Duty Current	ICCLTR	TRC=0V		250		μA
Normal mode VIN current	IVIN	ACS=2.0V, REF_IN=3V, ALC_C=0V, CS=0.6V, OUT=OPEN		1		mA
◀ VIN Over Voltage protection (OVP) Circuit ▶						
VIN Over Voltage protection Voltage	VINOVP		24	27	30	V
VIN Current at OVP	IINOVP	VIN=30V		10		mA
◀ CS pin abnormal sensing Circuit ▶						
Abnormal sensing Voltage	CSOCP		1.7	1.9	2.1	V

LV5012MD

Block Diagram

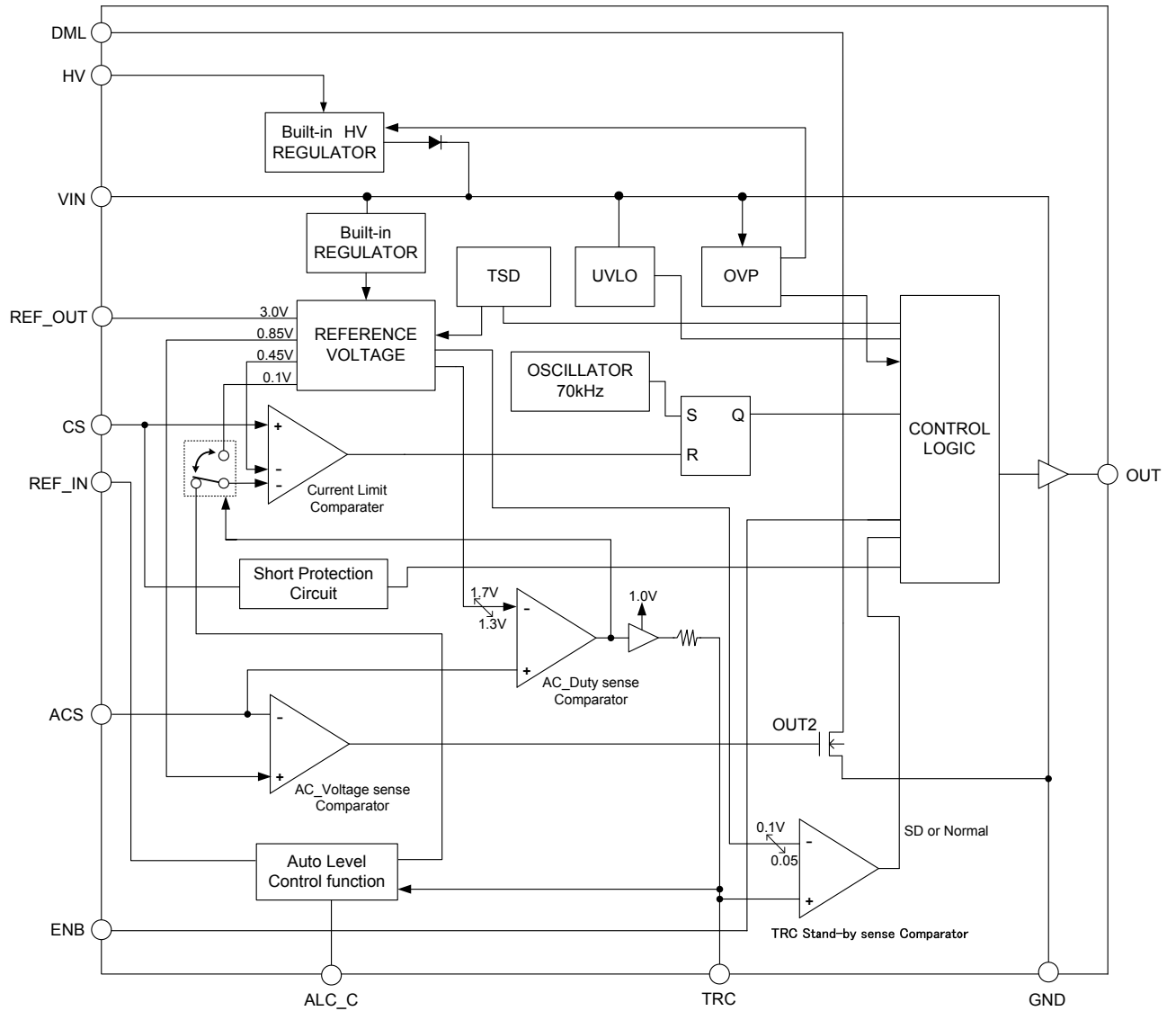

Pin Assignment

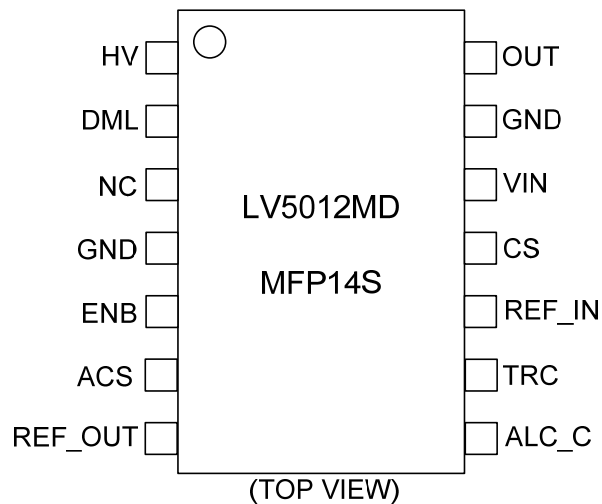

LV5012MD

Pin Function

No	Pin Symbol	Pin description
1	HV	Please connect about 10kΩ between this pin and the rectified AC voltage. Thereby HV regulator for IC startups operates.
2	DML	This pin is Drain of internal bleeder MOSFET. This pin is used in TRIAC dimming applications for TRIAC stabilization. Please connect the resistor "Rbl" between this pin and the rectified AC voltage. If ACS pin is below 0.85V, the internal bleeder MOS is turned on and bleeder current flows. Please set "Rbl" so that the voltage of DML pin does not exceed 55V when the bleeder MOS is turned on. [If this function not used, do not connect.]
3	NC	No connect pin
4	GND	GND pin.
5	ENB	Switching Operation ON/OFF pin. If the input of this pin is above 2V, OUT pin is fixed Low. If the input of this pin is below 1.8V, normal operation is started. Connect it to GND when unused.
6	ACS	This pin senses the rectified AC voltage for TRIAC dimming. If the voltage of this pin is below 0.85V, the internal bleeder MOS is turned on and bleeder current flows. If the voltage of this pin is above 1.7V, LV5012MD recognizes "TRIAC ON". If the voltage of this pin is below 1.3V, LV5012MD recognizes "TRIAC OFF". [If this function not used, please connect to REF_OUT pin.]
7	REF_OUT	Reference Voltage (3.0V) output pin.
8	ALC_C	This pin is used for Auto Level Control (ALC) function. Please connect a capacitor of about 0.1μF to GND. Thereby ALC_C pin can output the smoothing value of REF_IN pin voltage.
9	TRC	Please connect a capacitor about 1μF to GND, and a resistor about 4.7MΩ to VIN. If this pin is below 0.05V, the operation is stopped and VIN current is less than 250μA (typ). If this pin is above 0.1V, the operation is started.
10	REF_IN	This pin senses the rectified AC voltage for the ALC function.
11	CS	Current sense pin. When CS pin voltage exceeds the reference, the power MOSFET is turned off. (The details of the reference are described in following "Functional description".) If this pin voltage exceeds 1.9V, LV5012MD stops switching.
12	VIN	Power supply pin. Operation : VIN > UVLOON(9V) Stop : VIN < UVLOOFF(7.3V) Switching Stop : VIN > VINOVP(27V) Pull down to GND : VIN > 28V
13	GND	GND pin.
14	OUT	The external power MOSFET is driven by this pin. Please connect to MOSFET gate.

LV5012MD

Sample Application Circuit

Non-Isolation dimmable configuration

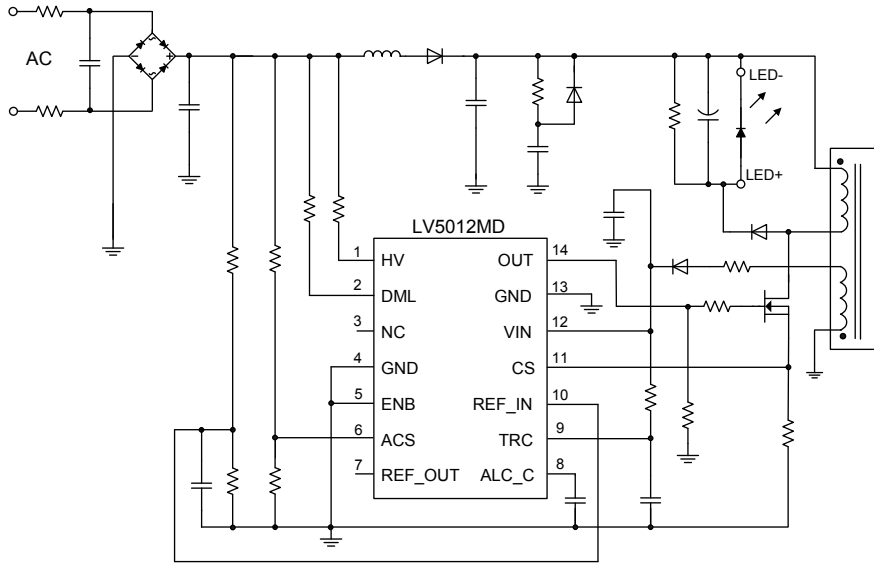

Isolation dimmable configuration

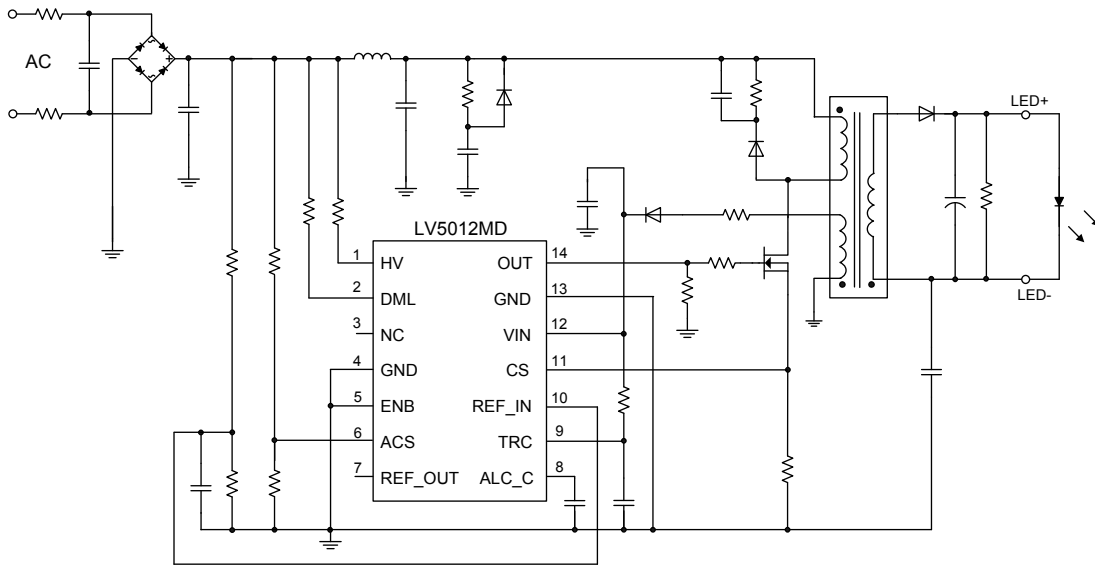

LV5012MD

Package Dimensions

unit : mm

SOIC14 W / MFP14S (225 mil)
CASE 751CB
ISSUE O

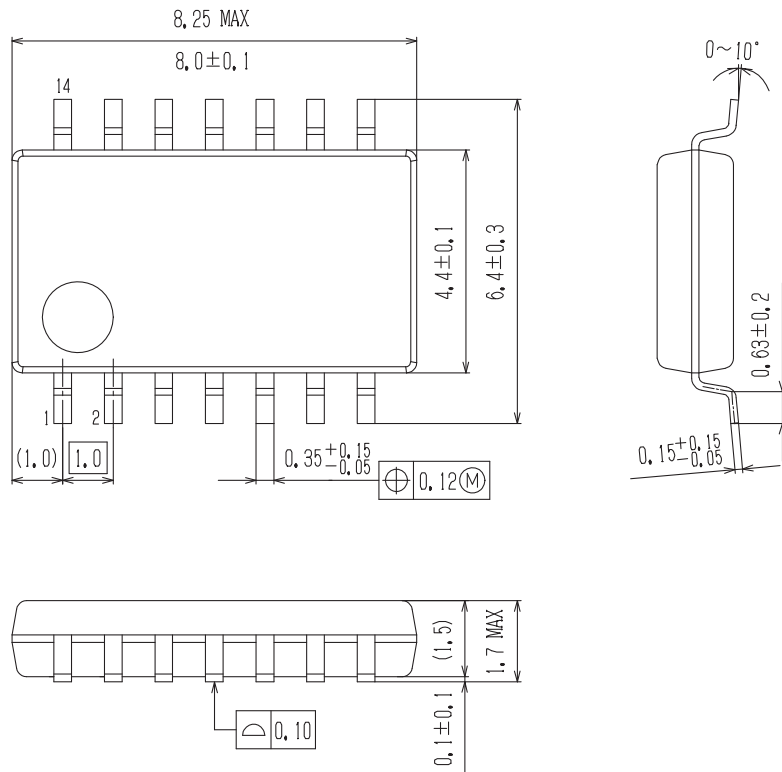

Pd max - Ta

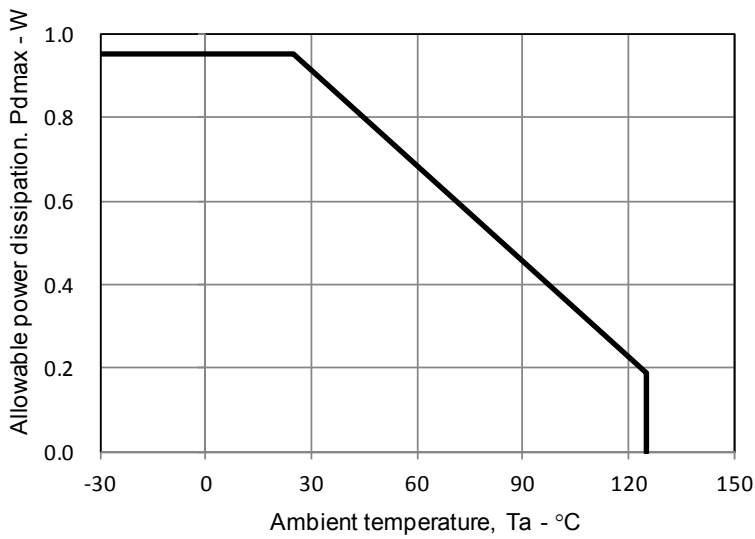

Specified board:
64mm×24mm×1.2mm,
glass epoxy board

LV5012MD

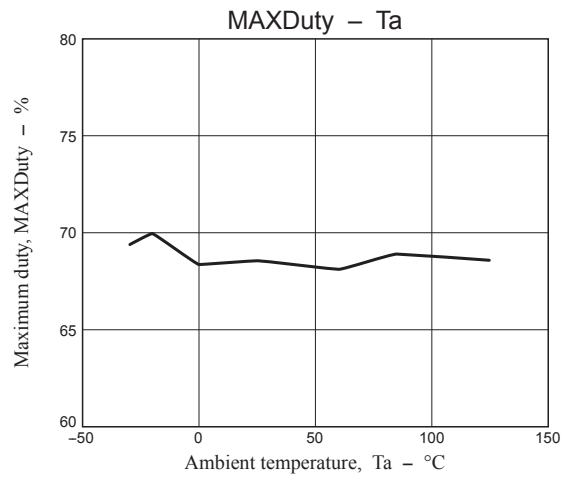
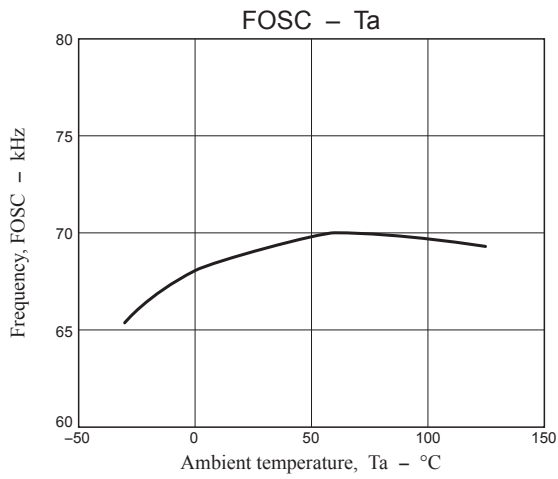
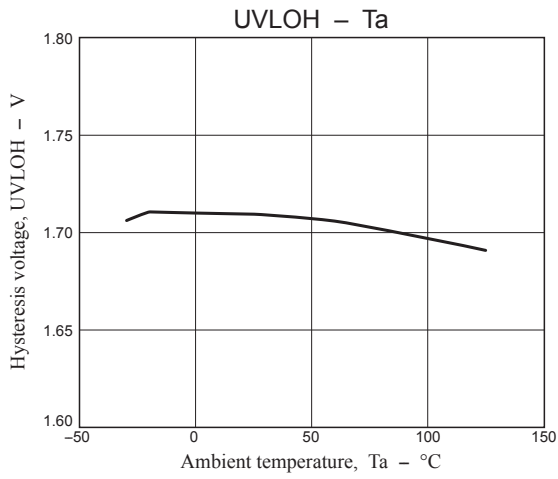
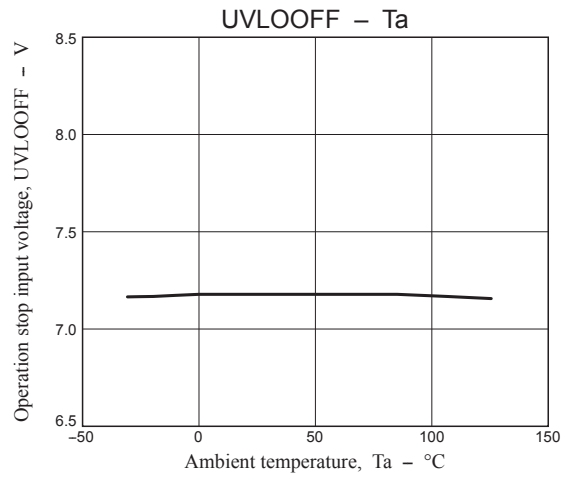
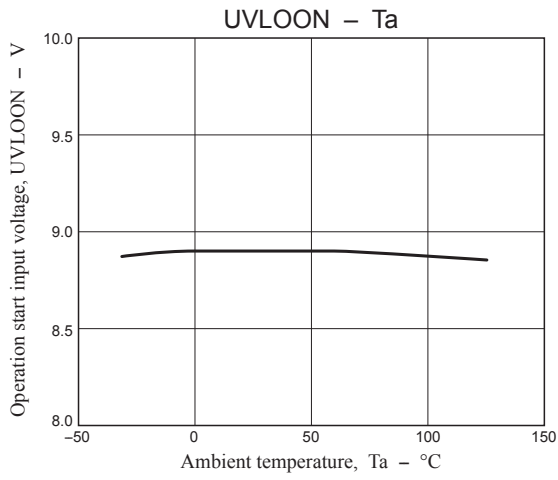
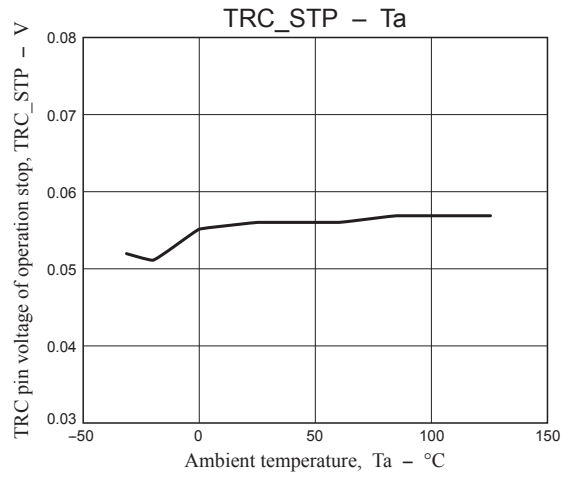
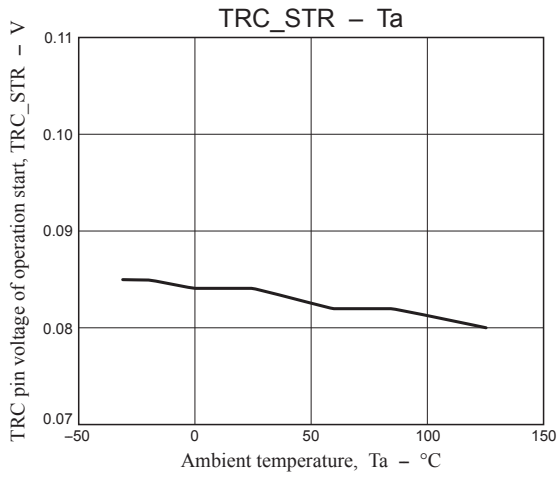

LV5012MD

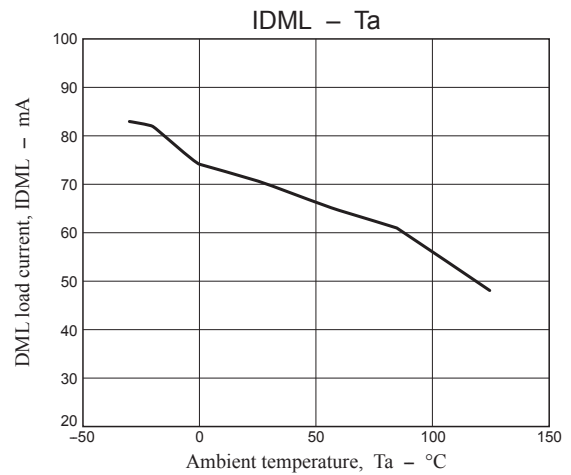
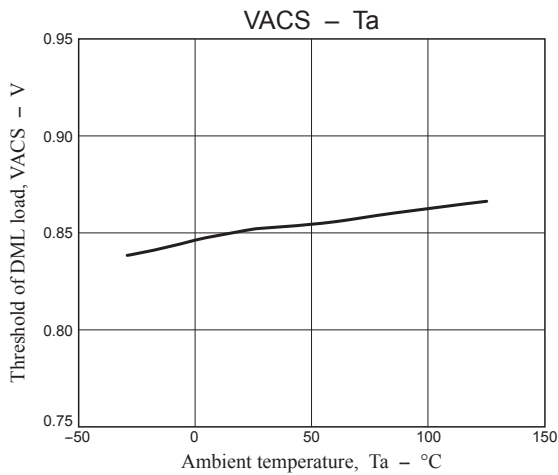
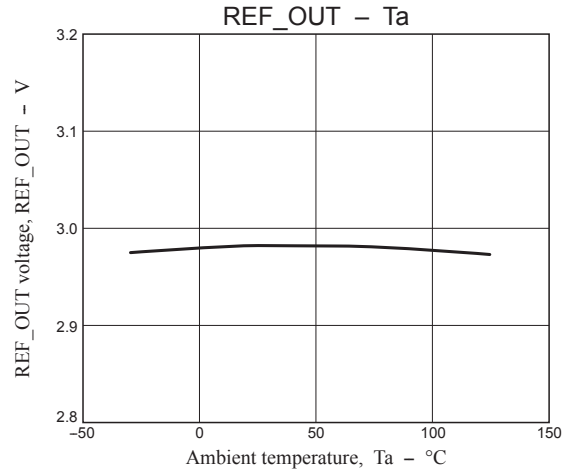
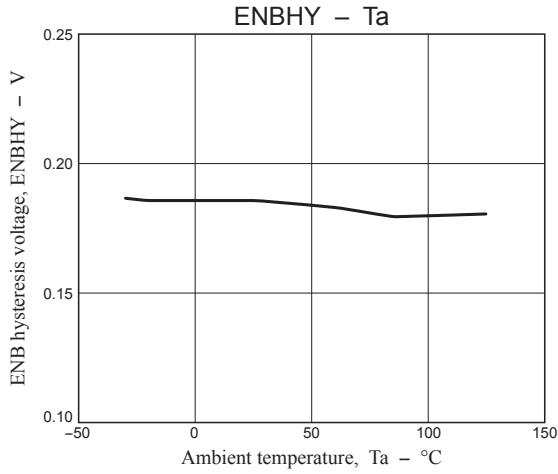
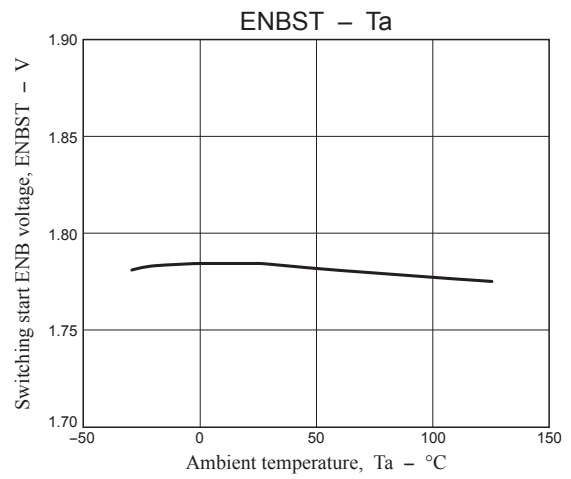
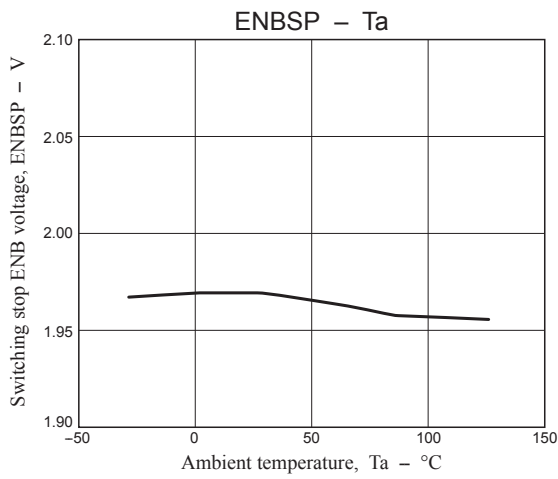
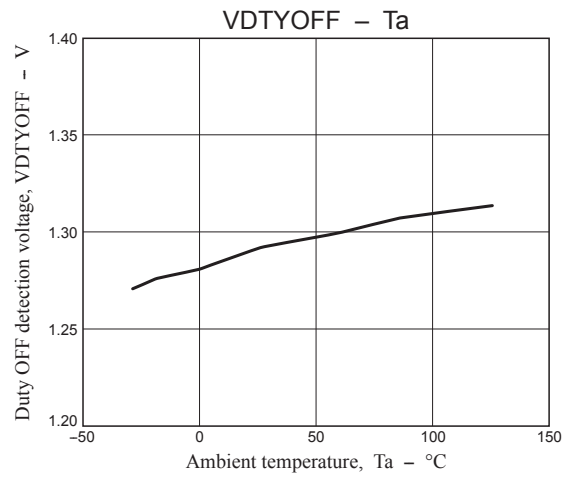
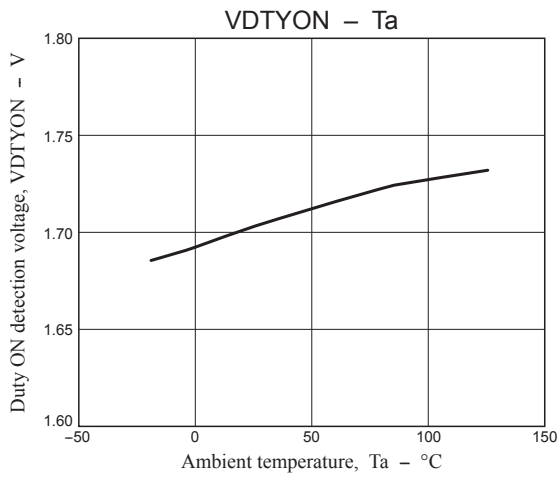

LV5012MD

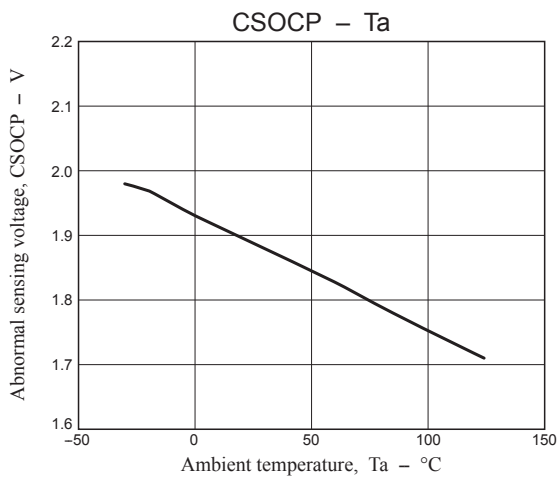
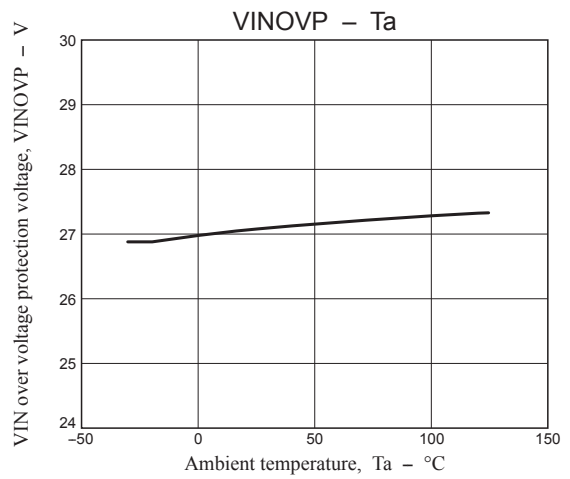
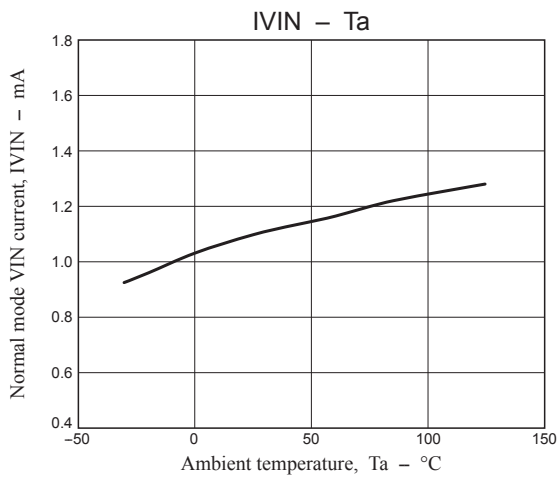
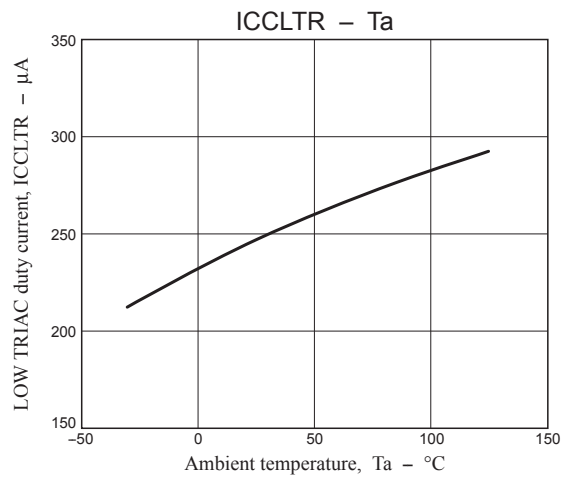
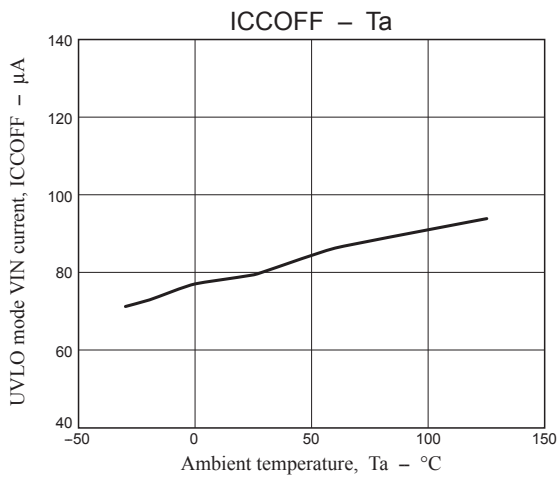
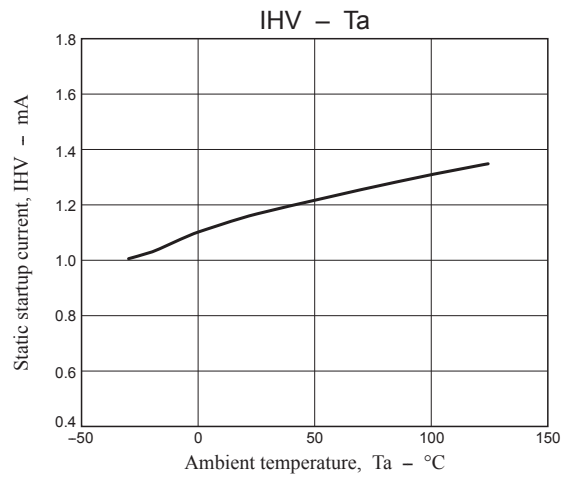
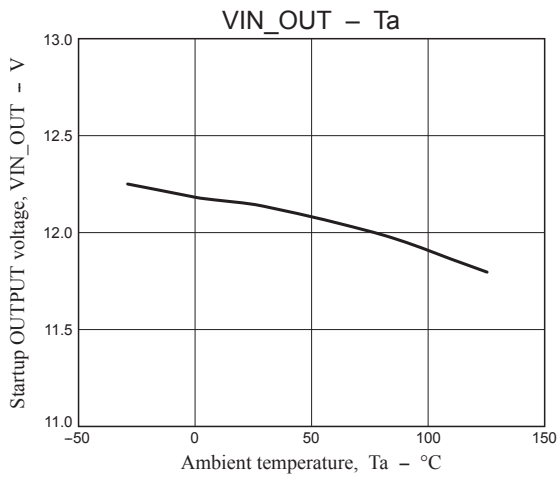

Functional description

LV5012MD is an LED driver IC that operates directly from the rectified AC voltage. LV5012MD controls brightness of the LED by controlling a peak current of the MOSFET.

1. Start up function

LV5012MD has a high voltage regulator built-in for self-supplying from the rectified AC voltage. It outputs 12V, and thereby the circuit in the IC starts. Please connect about 10kΩ between HV pin and the rectified AC voltage to operate HV regulator normally.

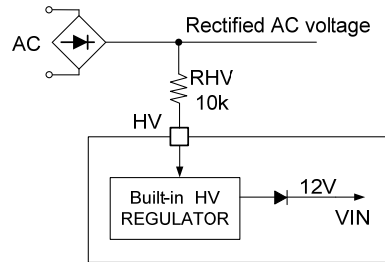

2. Peak current control

LV5012MD detects the current of external MOSFET as shown in the following diagram. The current that flows into MOSFET is a triangular wave shown in the diagram. The current peak value is determined by the relationship between the internal reference level and CS voltage. This relationship makes Power Factor Correction (PFC). CS voltage is used by internal comparator to compare to the reference level. And OUT pin outputs the signal for MOSFET control. LV5012MD controls the peak value of MOSFET current.

Here, the reference level is lower value of either "ALC_out" or "VREF(0.45V)". ("ALC_out" is described in "3. Auto Level Control function".)

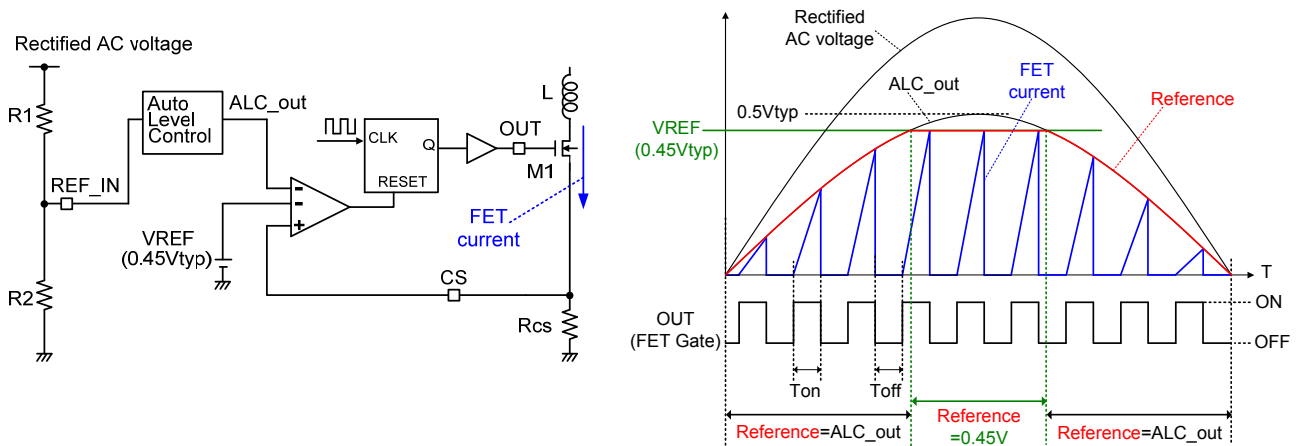

R1,R2 : External resistor for REF_IN pin setting
 Rcs : External resistor for current sense
 M1 : External Power MOSFET

The peak value of MOSFET current (I_{pk}) is determined by :

$$\text{In the case of "ALC_out < VREF(0.45V)" } \rightarrow I_{pk} = \frac{ALC_out}{Rcs}$$

$$\text{In the case of "ALC_out > VREF(0.45V)" } \rightarrow I_{pk} = \frac{0.45V}{Rcs}$$

3. Auto Level Control (ALC) function

Auto Level Control (ALC) function makes the sine wave reference voltage which doesn't depend on AC voltage. This function realizes both lower total harmonic distortion and good line regulation. ALC function is realized by calculation shown in the following diagram.

Sine wave is inputted into REF_IN pin. And ALC_C pin is the smoothing value of REF_IN pin voltage. The ALC_C pin voltage is compared with internal reference 0.5V by the "Larger Selection". If the value of ALC_C pin voltage is more than 0.5V, the "Larger Selection" outputs ALC_C voltage, otherwise outputs 0.5V. And the "Divider" divides the value of REF_IN pin voltage by the "Larger Selection" output. If the "Larger Selection" output is ALC_C voltage, the output of "Divider" is AC voltage-independent sine wave. The "Multiplier" adjusts amplitude to 0.5V peak sine wave.

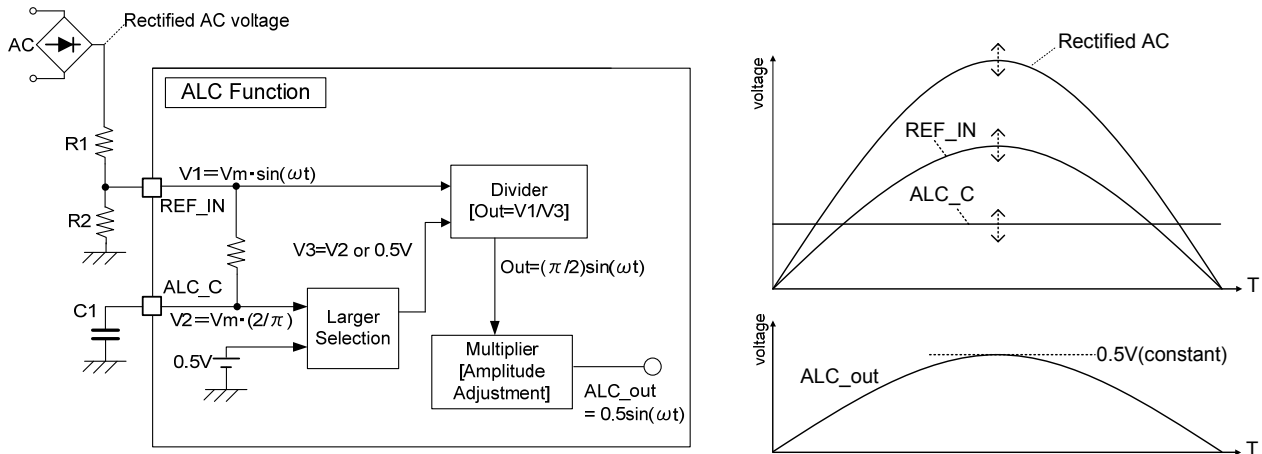

- R1, R2 setting

Please set R1, R2 so that the voltage peak of the REF_IN pin is around 1.1V to 1.9V.

e.g. Vac=230V → R1=680kΩ, R2=2.7kΩ

$$\text{REF_IN peak} = (230\text{V} \times \sqrt{2}) \times 2.7\text{k} / (680\text{k} + 2.7\text{k}) = 1.286\text{V}$$

- C1 setting

Please connect capacitor of about 0.1μF to an ALC_C pin.

4. Function for TRIAC dimming applications

LV5012MD contains the function for TRIAC dimming. This function is operated by setting ACS pin and DML pin.

4-1. TRIAC ON/OFF detection function

If ACS pin voltage is above 1.7V (internal fixed voltage), LV5012MD recognize "TRIAC ON". If ACS pin voltage is below 1.3V (internal fixed voltage), LV5012MD recognize "TRIAC OFF".

The peak value of MOSFET current is controlled by the following reference voltage level.

- During TRIAC ON (ACS > 1.7V)
The reference voltage level is lower value of either "ALC_out" or "VREF(0.45V)".
- During TRIAC OFF (ACS < 1.3V)
The reference voltage level is internal fixed 0.1V.

4-2. Bleeder current circuit

When ACS pin voltage is below 0.85V (internal fixed voltage), the built-in MOSFET for bleeder current is turned on and the bleeder current flows.

LV5012MD

The following shows a diagram of TRIAC Dimming.

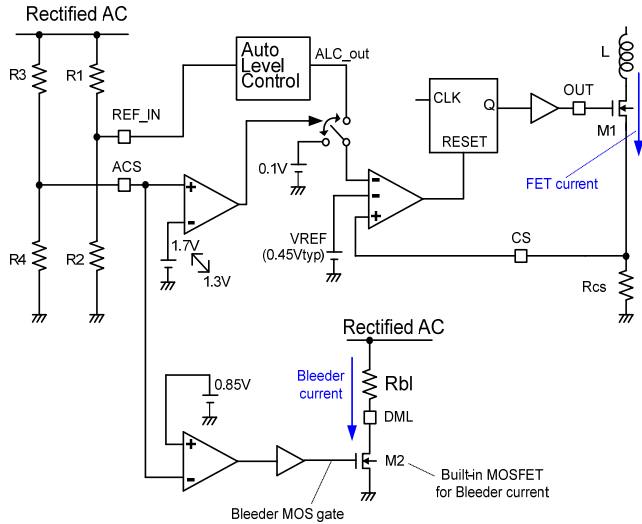

- R1,R2 : External resistor for REF_IN pin setting
- R3,R4 : External resistor for ACS pin setting
- Rbl : External resistor for bleeder current
- Rcs : External resistor for current sense
- Rbl : External resistor for bleeder current
- M1 : External Power MOSFET
- M2 : Internal MOSFET for bleeder current

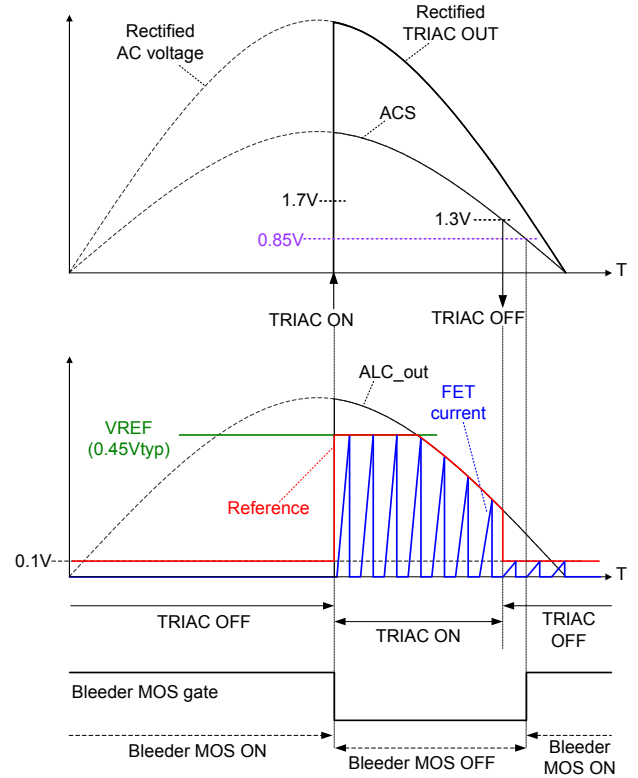

The peak value of MOSFET current (I_{pk}) is determined below

- During TRIAC ON ($ACS > 1.7V$)

$$\text{In the case of "ALC_out} < \text{VREF(0.45V)" } \rightarrow I_{pk} = \frac{ALC_out}{R_{cs}}$$

$$\text{In the case of "ALC_out} > \text{VREF(0.45V)" } \rightarrow I_{pk} = \frac{0.45V}{R_{cs}}$$

- During TRIAC OFF ($ACS < 1.3V$)

$$I_{pk} = \frac{0.1V}{R_{cs}}$$

The TRIAC ON threshold of the rectified AC is determined below.

$$Vac_{triac\ on} = \frac{R3 + R4}{R4} \times 1.7V$$

The TRIAC OFF threshold of the rectified AC is determined below.

$$Vac_{triac\ off} = \frac{R3 + R4}{R4} \times 1.3V$$

The Bleeder operation threshold of the rectified AC is determined below.

$$Vac_{bleeder} = \frac{R3 + R4}{R4} \times 0.85V$$

Please set R3, R4 on the basis of these expressions according to TRIAC dimmer.

In addition, please set Rbl between the rectified AC voltage and DML pin to satisfy the following expression.

$$\left(\frac{R3 + R4}{R4} \times 0.85V \right) - (Rbl \times 0.02) < 50V$$

5. Protection function

	tilte	Outline	monitor point
1	UVLO	Under Voltage Lock Out	VIN voltage
2	OC	Over Current Protection	CS voltage
3	OVP	Over Voltage Protection	VIN voltage
4	OTP	Over Temperature Protection	PN Junction temperature

5-1. UVLO(Under Voltage Lock Out)

If VIN voltage is 7.3V or lower, then UVLO operates and the IC stops. When UVLO operates, the power supply current of the IC is about 80uA or lower. If VIN voltage is 9V or higher, then the IC starts switching operation.

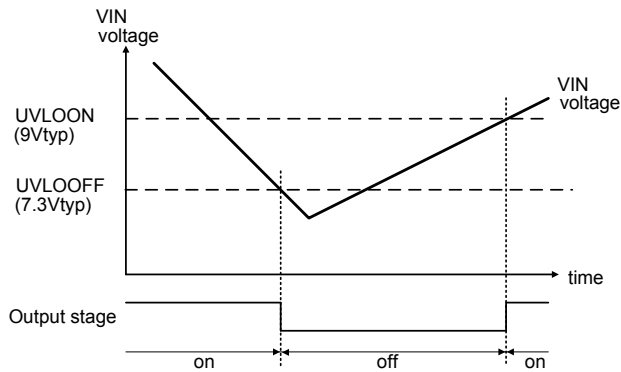

5-2. OCP(Over Current Protection)

CS pin is used to sense current in primary winding of transformer via external MOSFET. This provides an additional level of protection in the event of a fault. If the voltage of the CS pin exceeds VCSOCP(1.9V typ.)(A), the internal comparator will detect the event and turn off the MOSFET. The peak switch current is calculated

$$I_{ocp(peak)} [A] = V_{CSOCP}[V] / R_{cs}[\Omega]$$

The VIN pin is pulled down to fixed level, keeping the controller latched off. The latch reset occurs when the user disconnects LED from VAC and lets the VIN falls below the VIN reset voltage, UVLOFF(7.3V typ.)(B). Switching restarts when VIN rises UVLOON(9V typ.)(C).

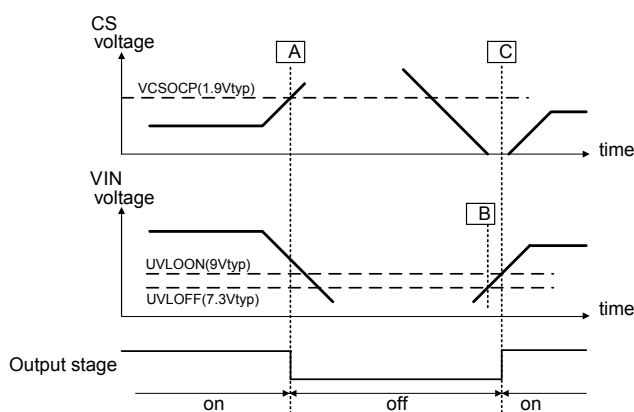

5-3. OVP(Over Voltage Protection)

If the voltage of VIN is higher than the internal reference voltage VINOVP(27V typ.), switching operation is stopped. The stopping operation is kept until the voltage of VIN is lower than VINOVP(27V typ.). If the voltage of VIN pin is lower than VINOVP(27V typ.), the switching operation is restated. Please see OVP waveform chart.

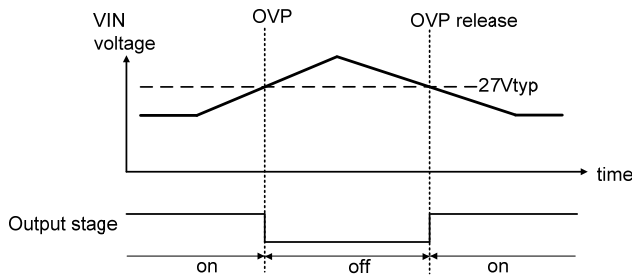

5-4. OTP(Over thermal protection)

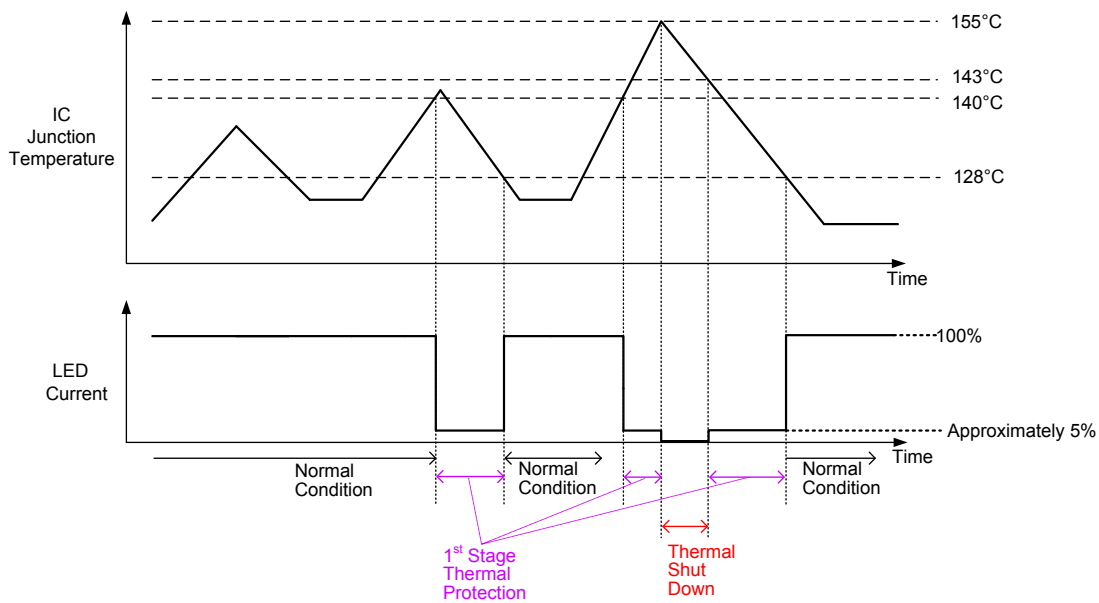

LV5012MD has the gradually thermal protection system. If the junction temperature exceeds 140 degrees Celsius, 1st stage protection mode is started. At 1st stage protection mode, the internal reference level compared with CS pin voltage is set to 0.1V. And the LED current is restricted to low values (approximately 5%).

If the junction temperature exceeds 155 degrees Celsius, the switching operation and startup circuit are stopped. Please see OTP waveform chart.



Looking for pricing, stock, or lifecycle information?

Click below to explore more details on WIN SOURCE:

-  [View LV5012MD-AH on WIN SOURCE](#)
-  [ON Semiconductor](#) Information

Optimize Your Supply Chain with WIN SOURCE Solutions

-  Global Sourcing Solution
-  Obsolete Management
-  Cost Control Management
-  Shortage Management
-  Alternative Solution
-  Excess Inventory Management