



# IR Emitter and Detector Product Data Sheet

LTR-4206E

Spec No.: DS-50-92-0073

Effective Date: 05/03/2000

Revision: C

**LITE-ON DCC**

**RELEASE**

BNS-OD-FC001/A4

**FEATURES**

- \* WIDE RANGE OF COLLECTOR CURRENT
- \* LENSED FOR HIGH SENSITIVITY
- \* LOW COST PLASTIC PACKAGE
- \* E-SPECIAL DARK PLASTIC PACKAGE THAT CUT THE VISIBLE LIGHT AND SUITABLE FOR THE DETECTORS OF INFRARED APPLICATIONS

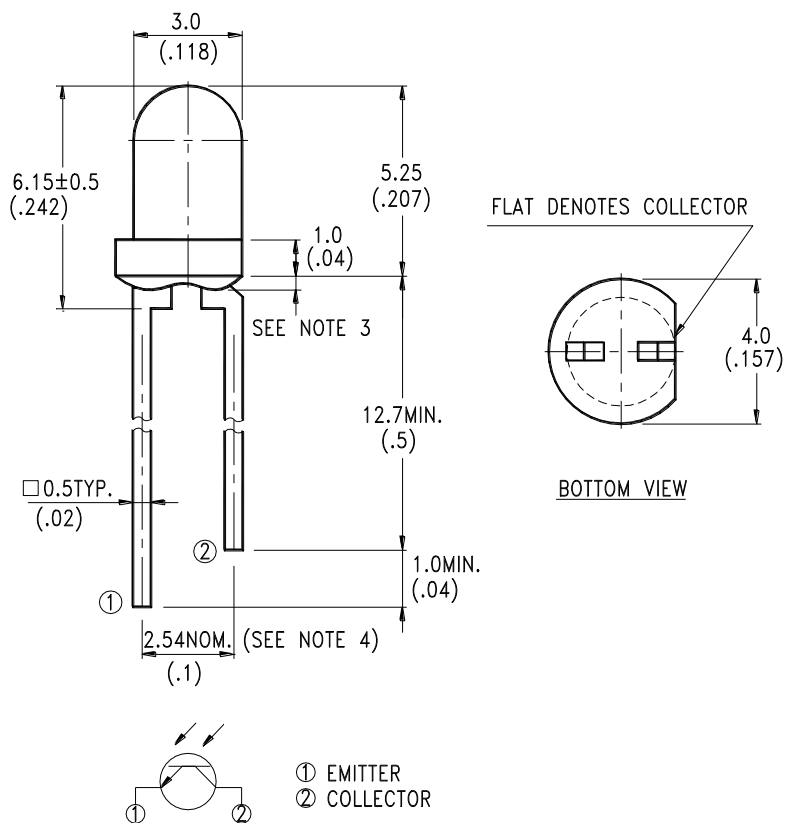
**PACKAGE DIMENSIONS****NOTES:**

1. All dimensions are in millimeters (inches).
2. Tolerance is  $\pm 0.25\text{mm}(.010\text{'})$  unless otherwise noted.
3. Protruded resin under flange is  $1.5\text{mm}(.059\text{'})$  max.
4. Lead spacing is measured where the leads emerge from the package.
5. Specifications are subject to change without notice for performance improvement.



## ABSOLUTE MAXIMUM RATINGS AT T<sub>A</sub>=25°C

PARAMETER	MAXIMUM RATING	UNIT
Power Dissipation	100	mW
Collector-Emitter Voltage	30	V
Emitter-Collector Voltage	5	V
Operating Temperature Range	-40°C to + 85°C	
Storage Temperature Range	-55°C to + 100°C	
Lead Soldering Temperature [1.6mm(.063") From Body]	260°C for 5 Seconds	



# LITE-ON ELECTRONICS, INC.

Property of Lite-On Only

## ELECTRICAL / OPTICAL CHARACTERISTICS AT T<sub>A</sub>=25°C

PARAMETER	SYMBOL	MIN.	TYP.	MAX.	UNIT	TEST CONDITION	BIN NO.
Collector-Emitter Breakdown Voltage	V <sub>(BR)CEO</sub>	30			V	I <sub>C</sub> = 1mA Ee = 0mW/cm <sup>2</sup>	
Emitter-Collector Breakdown Voltage	V <sub>(BR)ECO</sub>	5			V	I <sub>E</sub> = 100 μA Ee = 0mW/cm <sup>2</sup>	
Collector Emitter Saturation Voltage	V <sub>CE(SAT)</sub>			0.4	V	I <sub>C</sub> = 0.5mA Ee = 1mW/cm <sup>2</sup>	
Rise Time	Tr		10		μs	V <sub>CC</sub> = 5V I <sub>C</sub> = 1mA R <sub>L</sub> = 1KΩ	
Fall Time	Tf		10		μs		
Collector Dark Current	I <sub>CEO</sub>			100	nA	V <sub>CE</sub> = 10V Ee = 0mW/cm <sup>2</sup>	
On State Collector Current	I <sub>C(ON)</sub>	0.4		1.2	mA	V <sub>CE</sub> = 5V Ee = 1mW/cm <sup>2</sup> λ = 940nm	BIN B
		0.8		2.4			BIN C
		1.6		4.8			BIN D
		3.2		9.6			BIN E
		6.4					BIN F

## TYPICAL ELECTRICAL / OPTICAL CHARACTERISTICS CURVES

(25°C Ambient Temperature Unless Otherwise Noted)

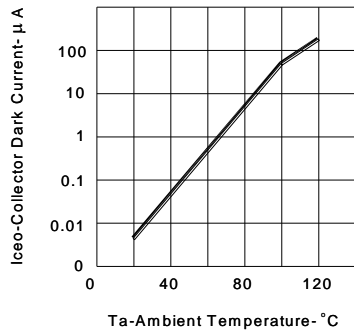

FIG.1 COLLECTOR DARK CURRENT VS AMBIENT TEMPERATURE

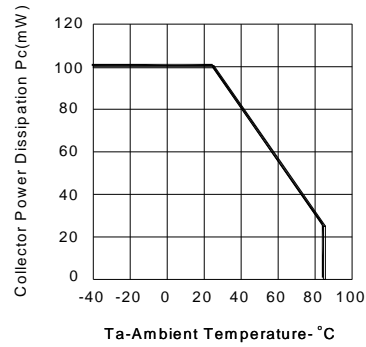

FIG.2 COLLECTOR POWER DISSIPATION VS AMBIENT TEMPERATURE

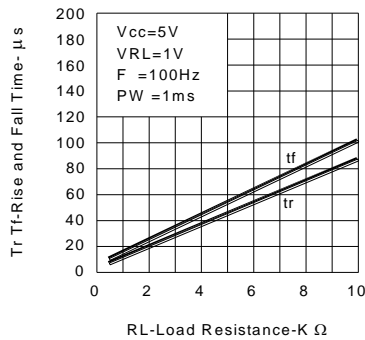

FIG.3 RISE AND FALL TIME VS LOAD RESISTANCE

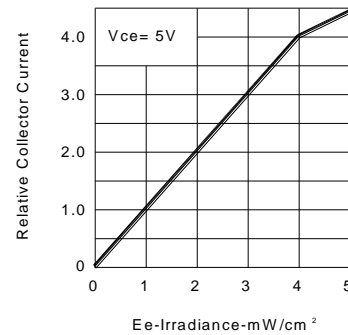

FIG.4 RELATIVE COLLECTOR CURRENT VS IRRADIANCE

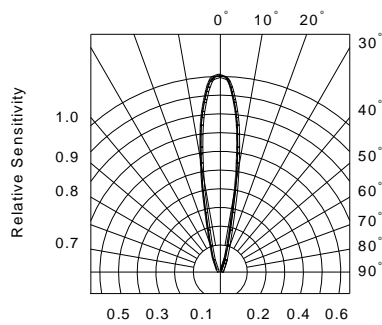









FIG.5 SENSITIVITY DIAGRAM

## Looking for pricing, stock, or lifecycle information?

Click below to explore more details on WIN SOURCE:

-  [View LTR-4206E on WIN SOURCE](#)
-  [Lite-On Inc. Information](#)

## Optimize Your Supply Chain with WIN SOURCE Solutions

-  Global Sourcing Solution
-  Obsolete Management
-  Cost Control Management
-  Shortage Management
-  Alternative Solution
-  Excess Inventory Management