



**THE DATASHEET OF
LTC6930CMS8-8.19#PBF**



FEATURES

- Frequency Error <0.09% Max at 25°C
- Start-Up Time <110 μ s at All Frequencies
- 1.7V to 5.5V Single Supply Operation
- 105 μ A Typical Supply Current at 32kHz, $V^+ = 3V$
- 490 μ A Typical Supply Current at 8MHz, $V^+ = 3V$
- Typical RMS Period Jitter <0.15% at $V^+ = 3V$
- No External Components to Set Frequency
- 5 Options Cover 32.768kHz to 8.192MHz:
 - LTC6930-4.19: 4.194304MHz \div N
 - LTC6930-5.00: 5.000000MHz \div N
 - LTC6930-7.37: 7.372800MHz \div N
 - LTC6930-8.00: 8.000000MHz \div N
 - LTC6930-8.19: 8.192000MHz \div N
 Where N = 1, 2, 4, 8, 16, 32, 64, 128
 (N Determined by State of DIVA, DIVB, DIVC Pins)
- -55°C to 125°C Operating Temperature Range
- Tiny 2mm \times 3mm DFN or MS8 Package

APPLICATIONS

- Digitally Controlled Oscillator
- Microprocessor Clock
- Power Supply Clock
- Portable and Battery Operated Devices

DESCRIPTION

The LTC[®]6930 series is a family of very low power precision silicon oscillators with a frequency error less than 0.09%. For each oscillator, the user can select one of 8 frequencies between 32.768kHz and 8.192MHz. Based on a fixed master oscillator frequency, internal frequency dividers between 1 and 128 provide the 8 different frequencies. The LTC6930 requires no external components other than power supply bypass capacitors. Requiring only a single 1.7V to 5.5V supply enables operation from a single Li-Ion cell or 2 AA alkaline cells.

The LTC6930 features a proprietary control architecture that allows for ultralow power operation while maintaining industry leading accuracy and jitter specifications. The exceptionally fast start-up time, combined with the low power consumption, is ideal for battery operated applications with frequent power-up cycles.

Any frequency from 32.768kHz to 8.192MHz can be provided by the factory. Minimum order sizes apply for custom frequencies. Please consult LTC Marketing for details.

LT, LT, LTC, LTM, Linear Technology and the Linear logo are registered trademarks and ThinSOT is a trademark of Linear Technology Corporation. All other trademarks are the property of their respective owners. Protected by U.S. Patents, including 6342817, 6614313.

TYPICAL APPLICATION

4MHz Micropower Clock Generator

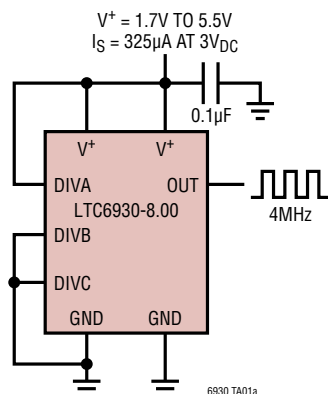

Typical Frequency Error Distribution



LTC6930-X.XX

ABSOLUTE MAXIMUM RATINGS

(Note 1)

Total Supply Voltage (V ⁺ to GND)	-0.3V to 6V
Any Input Pin to GND (DIV Pins)	-0.3V to V ⁺ + 0.3V
Operating Temperature Range (Note 2)	
LTC6930C	-40°C to 85°C
LTC6930I	-40°C to 85°C
LTC6930H	-40°C to 125°C
LT6930MP	-55°C to 125°C

Specified Temperature Range (Note 3)

LTC6930C	0°C to 70°C
LTC6930I	-40°C to 85°C
LTC6930H	-40°C to 125°C
LT6930MP	-55°C to 125°C
Storage Temperature Range	-65°C to 150°C
Lead Temperature (Soldering, 10 sec)	300°C

PIN CONFIGURATION

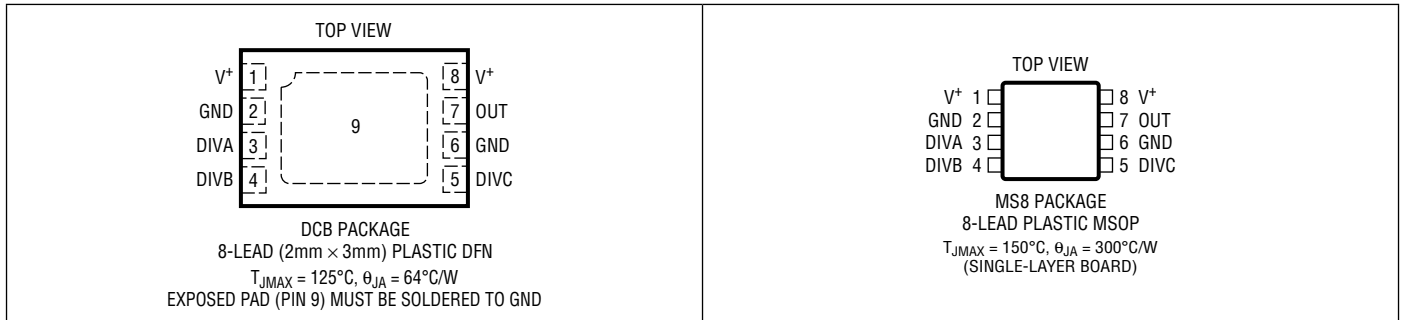

ORDER INFORMATION

Lead Free Finish

TAPE AND REEL (MINI)	TAPE AND REEL	PART MARKING*	PACKAGE DESCRIPTION	TEMPERATURE RANGE
LTC6930CDCB-4.19#TRMPBF	LTC6930CDCB-4.19#TRPBF	LCKT	8-Lead (2mm × 3mm) Plastic DFN	0°C to 70°C
LTC6930IDCB-4.19#TRMPBF	LTC6930IDCB-4.19#TRPBF	LCKT	8-Lead (2mm × 3mm) Plastic DFN	-40°C to 85°C
LTC6930HDCB-4.19#TRMPBF	LTC6930HDCB-4.19#TRPBF	LCKT	8-Lead (2mm × 3mm) Plastic DFN	-40°C to 125°C
LTC6930CDCB-5.00#TRMPBF	LTC6930CDCB-5.00#TRPBF	LCKV	8-Lead (2mm × 3mm) Plastic DFN	0°C to 70°C
LTC6930IDCB-5.00#TRMPBF	LTC6930IDCB-5.00#TRPBF	LCKV	8-Lead (2mm × 3mm) Plastic DFN	-40°C to 85°C
LTC6930HDCB-5.00#TRMPBF	LTC6930HDCB-5.00#TRPBF	LCKV	8-Lead (2mm × 3mm) Plastic DFN	-40°C to 125°C
LTC6930CDCB-7.37#TRMPBF	LTC6930CDCB-7.37#TRPBF	LCKW	8-Lead (2mm × 3mm) Plastic DFN	0°C to 70°C
LTC6930IDCB-7.37#TRMPBF	LTC6930IDCB-7.37#TRPBF	LCKW	8-Lead (2mm × 3mm) Plastic DFN	-40°C to 85°C
LTC6930HDCB-7.37#TRMPBF	LTC6930HDCB-7.37#TRPBF	LCKW	8-Lead (2mm × 3mm) Plastic DFN	-40°C to 125°C
LTC6930CDCB-8.00#TRMPBF	LTC6930CDCB-8.00#TRPBF	LCKX	8-Lead (2mm × 3mm) Plastic DFN	0°C to 70°C
LTC6930IDCB-8.00#TRMPBF	LTC6930IDCB-8.00#TRPBF	LCKX	8-Lead (2mm × 3mm) Plastic DFN	-40°C to 85°C
LTC6930HDCB-8.00#TRMPBF	LTC6930HDCB-8.00#TRPBF	LCKX	8-Lead (2mm × 3mm) Plastic DFN	-40°C to 125°C
LTC6930CDCB-8.19#TRMPBF	LTC6930CDCB-8.19#TRPBF	LCKY	8-Lead (2mm × 3mm) Plastic DFN	0°C to 70°C
LTC6930IDCB-8.19#TRMPBF	LTC6930IDCB-8.19#TRPBF	LCKY	8-Lead (2mm × 3mm) Plastic DFN	-40°C to 85°C
LTC6930HDCB-8.19#TRMPBF	LTC6930HDCB-8.19#TRPBF	LCKY	8-Lead (2mm × 3mm) Plastic DFN	-40°C to 125°C

TRM = 500 pieces.

6930fe

ORDER INFORMATION

LEAD FREE FINISH	TAPE AND REEL	PART MARKING*	PACKAGE DESCRIPTION	TEMPERATURE RANGE
LTC6930CMS8-4.19#PBF	LTC6930CMS8-4.19#TRPBF	LTCKZ	8-Lead Plastic MSOP	0°C to 70°C
LTC6930IMS8-4.19#PBF	LTC6930IMS8-4.19#TRPBF	LTCKZ	8-Lead Plastic MSOP	-40°C to 85°C
LTC6930HMS8-4.19#PBF	LTC6930HMS8-4.19#TRPBF	LTCKZ	8-Lead Plastic MSOP	-40°C to 125°C
LTC6930MPMS8-4.19#PBF	LTC6930MPMS8-4.19#TRPBF	LTCKZ	8-Lead Plastic MSOP	-55°C to 125°C
LTC6930CMS8-5.00#PBF	LTC6930CMS8-5.00#TRPBF	LTCLB	8-Lead Plastic MSOP	0°C to 70°C
LTC6930IMS8-5.00#PBF	LTC6930IMS8-5.00#TRPBF	LTCLB	8-Lead Plastic MSOP	-40°C to 85°C
LTC6930HMS8-5.00#PBF	LTC6930HMS8-5.00#TRPBF	LTCLB	8-Lead Plastic MSOP	-40°C to 125°C
LTC6930MPMS8-5.00#PBF	LTC6930MPMS8-5.00#TRPBF	LTCLB	8-Lead Plastic MSOP	-55°C to 125°C
LTC6930CMS8-7.37#PBF	LTC6930CMS8-7.37#TRPBF	LTCLC	8-Lead Plastic MSOP	0°C to 70°C
LTC6930IMS8-7.37#PBF	LTC6930IMS8-7.37#TRPBF	LTCLC	8-Lead Plastic MSOP	-40°C to 85°C
LTC6930HMS8-7.37#PBF	LTC6930HMS8-7.37#TRPBF	LTCLC	8-Lead Plastic MSOP	-40°C to 125°C
LTC6930MPMS8-7.37#PBF	LTC6930MPMS8-7.37#TRPBF	LTCLC	8-Lead Plastic MSOP	-55°C to 125°C
LTC6930CMS8-8.00#PBF	LTC6930CMS8-8.00#TRPBF	LTCLD	8-Lead Plastic MSOP	0°C to 70°C
LTC6930IMS8-8.00#PBF	LTC6930IMS8-8.00#TRPBF	LTCLD	8-Lead Plastic MSOP	-40°C to 85°C
LTC6930HMS8-8.00#PBF	LTC6930HMS8-8.00#TRPBF	LTCLD	8-Lead Plastic MSOP	-40°C to 125°C
LTC6930MPMS8-8.00#PBF	LTC6930MPMS8-8.00#TRPBF	LTCLD	8-Lead Plastic MSOP	-55°C to 125°C
LTC6930CMS8-8.19#PBF	LTC6930CMS8-8.19#TRPBF	LTCLF	8-Lead Plastic MSOP	0°C to 70°C
LTC6930IMS8-8.19#PBF	LTC6930IMS8-8.19#TRPBF	LTCLF	8-Lead Plastic MSOP	-40°C to 85°C
LTC6930HMS8-8.19#PBF	LTC6930HMS8-8.19#TRPBF	LTCLF	8-Lead Plastic MSOP	-40°C to 125°C
LTC6930MPMS8-8.19#PBF	LTC6930MPMS8-8.19#TRPBF	LTCLF	8-Lead Plastic MSOP	-55°C to 125°C

Consult LTC Marketing for parts specified with wider operating temperature ranges. *Temperature grades are identified by a label on the shipping container. Consult LTC Marketing for information on lead based finish parts.

For more information on lead free part marking, go to: <http://www.linear.com/leadfree/>

For more information on tape and reel specifications, go to: <http://www.linear.com/tapeandree/>

AC ELECTRICAL CHARACTERISTICS The ● denotes the specifications which apply over the full operating temperature range, otherwise specifications are at $T_A = 25^\circ\text{C}$. Unless otherwise noted, specifications apply over the full range of operating supply voltage and frequency output: $V^+ = 1.7\text{V to }5.5\text{V}$ and all DIV settings with $C_{\text{LOAD}} = 5\text{pF}$, $R_{\text{LOAD}} = \infty$.

SYMBOL	PARAMETER	CONDITIONS	MIN	TYP	MAX	UNITS
Δf_i	Initial Frequency Accuracy	$\text{DIVA} = \text{DIVB} = \text{DIVC} = 0$, $T_A = 25^\circ\text{C}$, $V^+ = 3\text{V}$		0.08	0.09	%
Δf	Frequency Accuracy (Note 4)	$V^+ = 3\text{V} - 3.6\text{V}$				
		LTC6930C ●	± 0.1	± 0.45	%	
		LTC6930I ●	± 0.1	± 0.65	%	
		LTC6930H/LTC6930MP ●	± 0.1	± 1	%	
		$V^+ = 2\text{V} - 3.6\text{V}$				
		LTC6930C ●	± 0.1	± 0.52	%	
		LTC6930I ●	± 0.1	± 0.65	%	
		LTC6930H/LTC6930MP ●	± 0.1	± 1.1	%	
		$V^+ = 1.7\text{V} - 5.5\text{V}$				
LTC6930C ●	± 0.1	± 0.8	%			
LTC6930I ●	± 0.1	± 0.95	%			
LTC6930H/LTC6930MP ●	± 0.1	± 1.3	%			
$\Delta f/\Delta T$	Frequency Drift Over Temperature	MS8 Package ●		0.0001		%/°C
		DCB Package ●		0.001		%/°C
$\Delta f/\Delta V$	Frequency Drift Over Supply	●		0.07		%/V
	Long-Term Frequency Stability	(Note 5) ●		30		ppm/ $\sqrt{\text{kHr}}$

6930fe

AC ELECTRICAL CHARACTERISTICS The ● denotes the specifications which apply over the full operating temperature range, otherwise specifications are at $T_A = 25^\circ\text{C}$. Unless otherwise noted, specifications apply over the full range of operating supply voltage and frequency output: $V^+ = 1.7\text{V}$ to 5.5V and all DIV settings with $C_{\text{LOAD}} = 5\text{pF}$, $R_{\text{LOAD}} = \infty$.

SYMBOL	PARAMETER	CONDITIONS	MIN	TYP	MAX	UNITS
	RMS Period Jitter	DIVA = DIVB = DIVC = 0, $V^+ = 3\text{V}$ LTC6930-4.19 (4.194304MHz)		320		ps RMS
		LTC6930-5.00 (5.000000MHz)		1.7		ns _{p-p}
		LTC6930-7.37 (7.372800MHz)		225		ps RMS
		LTC6930-8.00 (8.000000MHz)		1.2		ns _{p-p}
		LTC6930-8.19 (8.192000MHz)		180		ps RMS
					0.97	
			130		ps RMS	
			0.8		ns _{p-p}	
			130		ps RMS	
			0.8		ns _{p-p}	

DC ELECTRICAL CHARACTERISTICS The ● denotes the specifications which apply over the full operating temperature range, otherwise specifications are at $T_A = 25^\circ\text{C}$. Unless otherwise noted, specifications apply over the full range of operating supply voltage and frequency output: $V^+ = 1.7\text{V}$ to 5.5V and all DIV settings with $C_{\text{LOAD}} = 5\text{pF}$, $R_{\text{LOAD}} = \infty$.

SYMBOL	PARAMETER	CONDITIONS	MIN	TYP	MAX	UNITS		
V_S	Supply Voltage Applied Between V^+ and GND		●	1.7	5.5	V		
$I_{S,DC}$	V^+ Combined Supply Current	LTC6930-4.19						
		DIVA = DIVB = DIVC = 0, $V^+ = 1.7\text{V}$	●	170	290	μA		
		DIVA = DIVB = DIVC = 0, $V^+ = 3\text{V}$	●	260	420	μA		
		DIVA = DIVB = DIVC = 0, $V^+ = 5.5\text{V}$	●	490	750	μA		
		DIVA = DIVB = DIVC = 1, $V^+ = 1.7\text{V}$	●	80	160	μA		
		DIVA = DIVB = DIVC = 1, $V^+ = 3\text{V}$	●	105	190	μA		
		DIVA = DIVB = DIVC = 1, $V^+ = 5.5\text{V}$	●	130	355	μA		
		LTC6930-5.00						
		DIVA = DIVB = DIVC = 0, $V^+ = 1.7\text{V}$	●	201	430	μA		
		DIVA = DIVB = DIVC = 0, $V^+ = 3\text{V}$	●	307	570	μA		
		DIVA = DIVB = DIVC = 0, $V^+ = 5.5\text{V}$	●	579	960	μA		
		DIVA = DIVB = DIVC = 1, $V^+ = 1.7\text{V}$	●	95	176	μA		
		DIVA = DIVB = DIVC = 1, $V^+ = 3\text{V}$	●	124	212	μA		
		DIVA = DIVB = DIVC = 1, $V^+ = 5.5\text{V}$	●	154	375	μA		
$I_{S,DC}$	V^+ Combined Supply Current	LTC6930-7.37						
		DIVA = DIVB = DIVC = 0, $V^+ = 1.7\text{V}$	●	296	480	μA		
		DIVA = DIVB = DIVC = 0, $V^+ = 3\text{V}$	●	453	660	μA		
		DIVA = DIVB = DIVC = 0, $V^+ = 5.5\text{V}$	●	853	1310	μA		
		DIVA = DIVB = DIVC = 1, $V^+ = 1.7\text{V}$	●	139	220	μA		
		DIVA = DIVB = DIVC = 1, $V^+ = 3\text{V}$	●	183	273	μA		
		DIVA = DIVB = DIVC = 1, $V^+ = 5.5\text{V}$	●	226	440	μA		
		LTC6930-8.00						
		DIVA = DIVB = DIVC = 0, $V^+ = 1.7\text{V}$	●	321	520	μA		
		DIVA = DIVB = DIVC = 0, $V^+ = 3\text{V}$	●	491	740	μA		
		DIVA = DIVB = DIVC = 0, $V^+ = 5.5\text{V}$	●	926	1380	μA		
		DIVA = DIVB = DIVC = 1, $V^+ = 1.7\text{V}$	●	151	240	μA		
		DIVA = DIVB = DIVC = 1, $V^+ = 3\text{V}$	●	198	295	μA		
		DIVA = DIVB = DIVC = 1, $V^+ = 5.5\text{V}$	●	246	475	μA		
		LTC6930-8.19						
		DIVA = DIVB = DIVC = 0, $V^+ = 1.7\text{V}$	●	310	490	μA		
		DIVA = DIVB = DIVC = 0, $V^+ = 3\text{V}$	●	500	760	μA		
		DIVA = DIVB = DIVC = 0, $V^+ = 5.5\text{V}$	●	880	1400	μA		
		DIVA = DIVB = DIVC = 1, $V^+ = 1.7\text{V}$	●	150	270	μA		
		DIVA = DIVB = DIVC = 1, $V^+ = 3\text{V}$	●	190	325	μA		
		DIVA = DIVB = DIVC = 1, $V^+ = 5.5\text{V}$	●	210	540	μA		
		V_{IH}	Minimum High Level Input Voltage, All Digital Input Pins		●	1.25	1.4	V

DC ELECTRICAL CHARACTERISTICS The ● denotes the specifications which apply over the full operating temperature range, otherwise specifications are at $T_A = 25^\circ\text{C}$. Unless otherwise noted, specifications apply over the full range of operating supply voltage and frequency output: $V^+ = 1.7\text{V}$ to 5.5V and all DIV settings with $C_{\text{LOAD}} = 5\text{pF}$, $R_{\text{LOAD}} = \infty$.

SYMBOL	PARAMETER	CONDITIONS	MIN	TYP	MAX	UNITS	
V_{IL}	Maximum Low Level Input Voltage, All Digital Input Pins		● 0.7	1.25		V	
I_{IN}	Digital Input Leakage Current, All Digital Input Pins	$0 < V_{\text{IN}} < V^+$	●		±1	μA	
R_{OUT}	Output Resistance	OUT Pin, $V^+ = 3\text{V}$		40		Ω	
V_{OH}	High Level Output Voltage	DIVA = DIVB = DIVC = 0, No Load	●				
		$V^+ = 5.5\text{V}$	●	5.4	5.5	V	
		$V^+ = 3\text{V}$	●	2.9	3	V	
		$V^+ = 2\text{V}$	●	1.8	2	V	
		$V^+ = 1.7\text{V}$			1.7	V	
		DIVA = DIVB = DIVC = 0, 1kΩ Load to GND	●				
V_{OL}	Low Level Output Voltage	$V^+ = 5.5\text{V}$	●		0	0.1	V
		$V^+ = 3\text{V}$	●		0	0.1	V
		$V^+ = 2\text{V}$	●		0	0.1	V
		$V^+ = 1.7\text{V}$			0		V
		DIVA = DIVB = DIVC = 0, 1kΩ Load to V^+	●				
		$V^+ = 5.5\text{V}$	●		0.3	0.7	V
	$V^+ = 3\text{V}$	●		0.3	0.5	V	
	$V^+ = 2\text{V}$	●		0.3	0.35	V	
	$V^+ = 1.7\text{V}$			0.3		V	

TIMING CHARACTERISTICS The ● denotes the specifications which apply over the full operating temperature range, otherwise specifications are at $T_A = 25^\circ\text{C}$. Unless otherwise noted, specifications apply over the full range of operating supply voltage and frequency output: $V^+ = 1.7\text{V}$ to 5.5V and $f_{\text{OUT}} = 32.768\text{kHz}$ to 8.192MHz with $C_{\text{LOAD}} = 5\text{pF}$, $R_{\text{LOAD}} = \infty$.

SYMBOL	PARAMETER	CONDITIONS	MIN	TYP	MAX	UNITS	
t_{rf}	Output Rise/Fall Time (10% to 90%)	$V^+ = 3\text{V}$		3		ns	
DCY	Duty Cycle	DIVA = DIVB = DIVC = 0; $V^+ = 2\text{V}$ to 5.5V	●	35	50	65	%
		DIVA = DIVB = DIVC = 0	●	35	50	70	%
		DIVA or DIVB or DIVC \neq 0	●	48	50	52	%
D_{DIV}	DIV to OUT Delay	Edge of DIV Signal to 1st Accurate Output Cycle		1		Cycle	
D_{PON}	Power On Delay	$V^+ > 1.7\text{V}$ to 1st Accurate Output Cycle	●		110	μs	

Note 1: Stresses beyond those listed under Absolute Maximum Ratings may cause permanent damage to the device. Exposure to any Absolute Maximum Rating condition for extended periods may affect device reliability and lifetime.

Note 2: LTC6930C is guaranteed functional over the operating range of -40°C to 85°C .

Note 3: The LTC6930C is guaranteed to meet specified performance from 0°C to 70°C . The LTC6930C is designed, characterized and expected to meet specified performance from -40°C to 85°C but is not tested or QA sampled at these temperatures. The LTC6930I is guaranteed to meet specified performance from -40°C to 85°C . The LTC6930H is guaranteed to meet specified performance from -40°C to 125°C . The LTC6930MP is guaranteed to meet specified performance from -55°C to 125°C .

Note 4: Frequency accuracy and frequency drift are defined as deviation from the nominal frequency or the nominal frequency divided by the integer set through the DIV pins for each part. The nominal frequency for

the LTC6930 family of parts are defined as follows:

LTC6930-4.19	$f_{\text{NOM}} = 4.194304\text{MHz}$
LTC6930-5.00	$f_{\text{NOM}} = 5.000000\text{MHz}$
LTC6930-7.37	$f_{\text{NOM}} = 7.372800\text{MHz}$
LTC6930-8.00	$f_{\text{NOM}} = 8.000000\text{MHz}$
LTC6930-8.19	$f_{\text{NOM}} = 8.192000\text{MHz}$

Note 5: Long-term drift of silicon oscillators is primarily due to the movement of ions and impurities within the silicon and is tested at 30°C under otherwise nominal operating conditions. Long-term drift is specified as $\text{ppm}/\sqrt{\text{kHr}}$ due to the typically non-linear nature of the drift. To calculate drift for a set time period, translate that time into thousands of hours, take the square root and multiply by the typical drift number. For instance, a year is 8.77kHr and would yield a drift of 89ppm at $30\text{ppm}/\sqrt{\text{kHr}}$. Drift without power applied to the device may be approximated as 1/10th of the drift with power, or $3\text{ppm}/\sqrt{\text{kHr}}$ for a $30\text{ppm}/\sqrt{\text{kHr}}$ device.

TYPICAL PERFORMANCE CHARACTERISTICS

Typical Frequency Error vs Supply Voltage

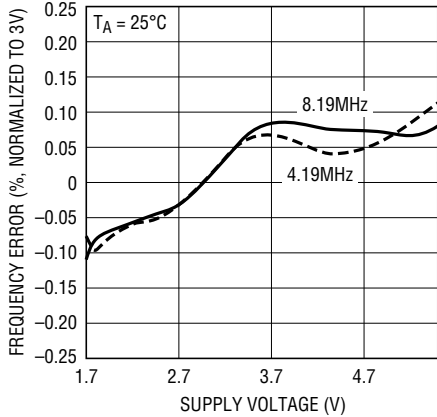

4216 G01

Typical Frequency Error vs Temperature, MS8 Package (Note 3)

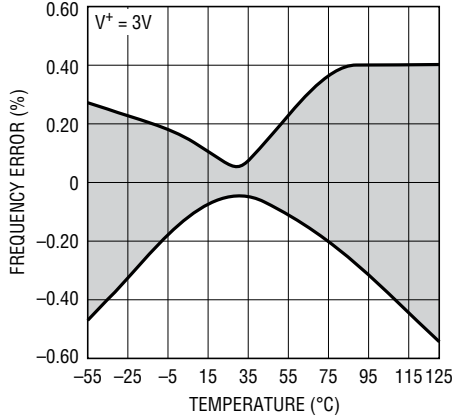

4216 G02

Typical Frequency Error vs Temperature, DFN Package (Note 3)

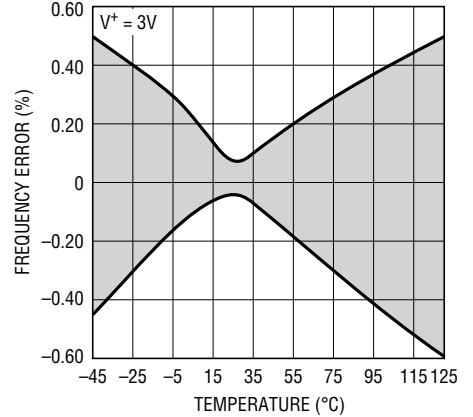

4216 G03

Typical Supply Current vs DIV Setting

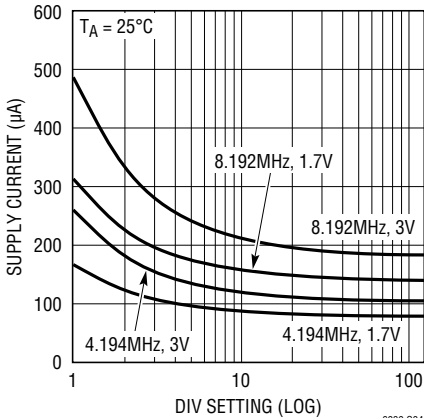

6930 G04

Typical Supply Current vs Load Capacitance

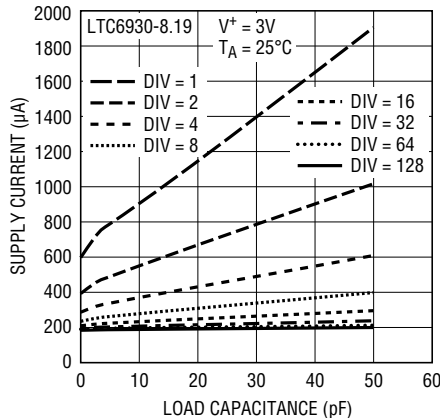

4216 G05

Typical Supply Current vs Supply Voltage

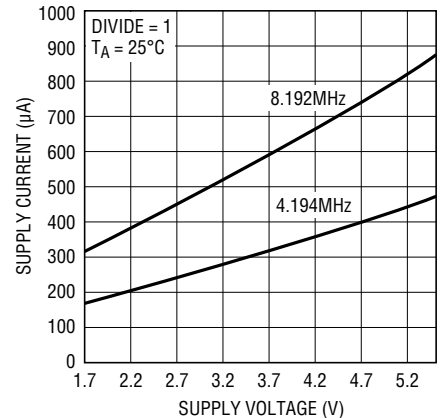

4216 G06

Typical Supply Current vs Temperature (Note 3)



4216 G07

Typical Output Spectrum, 8MHz



6930 G08

Typical Output Waveform, 8MHz



6930 G09

LTC6930-8.00
CLoad = 12pF

TYPICAL PERFORMANCE CHARACTERISTICS

Typical Jitter vs Supply in Divide by 1 Mode



4216 G10

Typical Period Jitter Histogram



4216 G11

Typical Jitter vs Divider Setting



6930 G12

Typical Output Rise/Fall Time vs Supply



4216 G13

Typical Output Resistance vs Supply Voltage



4216 G14

Typical Output Duty Cycle vs Supply and Divide Ratio



4216 G15

Typical Frequency Settling from Power-Up



4216 G16

Typical Frequency Error vs Time (Long-Term Drift)



4216 G17

Typical Output Waveform at DIV Pin Change



6930 G18

PIN FUNCTIONS

V⁺ (Pins 1, 8): Positive Supply Pins. Each supply pin should be bypassed directly to the neighboring GND pin with a 0.1μF ceramic capacitor, and must be externally connected to the other V⁺ pin (see recommended layout).

GND (Pins 2, 6): Ground Pins. Each should be connected to a low inductance ground plane and must be connected to the other GND pin and on the DFN package, Pin 9.

DIVA, DIVB, DIVC (Pins 3, 4, 5): Output Prescaler. Selects divide ratio of master oscillator frequency used to generate the output. See frequency setting Table 1 for function. These are standard CMOS logic inputs with a typical threshold of 1.25V

OUT (Pin 7): Oscillator Output. Drives up to 50pF capacitive or 1k resistive load (Refer to Supply Current vs Load Capacitance in Typical Performance Characteristics section). Typical series resistance is less than 80Ω at 1.7V and less than 40Ω at 3V supply. The output trace should be isolated as much as possible from Pin 1 and Pin 2. The OUT pin is held low during start-up, and remains free from glitches and runt pulses during DIV pin switching.

Exposed Pad (Pin 9, DFN Only): The Exposed Pad must be soldered to a PCB plane connected to GND.

APPLICATIONS INFORMATION

Theory of Operation

The LTC6930 is an entirely self contained all silicon oscillator which consists of a master oscillator, a control loop and an output frequency divider. The master oscillator operates between 4.2MHz and 8.2MHz and is factory programmed. The master oscillator frequency is accurately maintained over temperature and environmental extremes by a proprietary switched capacitor feedback loop.

Each LTC6930 oscillator has an output frequency divider which is controlled via the DIVA, DIVB and DIVC inputs. The divider divides the master frequency by 2^N, where N is an integer from 0 to 7 (divider ranges from 1 to 128). See Table 1 for the full range of frequencies covered by the LTC6930 family.

The presence of two sets of supply pins and careful internal layout reduce interference between the oscillator output and the control loop. This allows the LTC6930 to provide a clean output frequency with very little deterministic jitter, even in cases of heavy output loading and noisy operating environments.

The supply voltage of the LTC6930 is internally regulated to maintain a very low frequency drift over supply.

Output Driver and Loading

The output of the LTC6930 is a low series resistance 40Ω CMOS driver with controlled rise/fall times to limit RF interference and power supply spikes generated by the output while preserving the ability to drive low impedance loads. Especially at high frequencies, the capacitive loading of the output of the LTC6930 may cause the majority of the power supply dissipation of the part.

The LTC6930 supply current is specified at an output load of 5pF, which is equivalent to two standard HC logic inputs. The portion of the power supply current needed to drive a capacitive load may be calculated as:

$$I_{\text{SUPPLY}} = C_{\text{LOAD}} \cdot V_{\text{SWING}} \cdot f_{\text{OSC}}$$

where C_{LOAD} is the 5pF load capacitance, V_{SWING} is the voltage swing, in this case up to 5.5V, and f_{OSC} is the frequency of the oscillator output. Driving a 5.5V swing into a 5pF load at 8MHz takes an average of 220μA. To calculate the portion of the supply current needed for a 50pF load, simply substitute 50pF for C_{LOAD} in the same equation:

$$50\text{pF} \cdot 5.5\text{V} \cdot 8\text{MHz} = 2.2\text{mA}$$

The majority of this power is expended during the rise and fall time of the output signal, not while it is in a steady

APPLICATIONS INFORMATION

state. The 2ns rise and fall times of the LTC6930 mean that the instantaneous power supply current required during the rise and fall portions of the waveform is much greater than the average.

The instantaneous power supply current may be calculated by a similar formula:

$$I_{\text{PEAK}} = C_{\text{LOAD}} \cdot V_{\text{SWING}} \cdot \frac{1}{t_{\text{rf}}}$$

where t_{rf} is the rise/fall time of the signal. In this case, 14mA spikes are generated by driving 5.5V into a 5pF load.

Power is supplied to the output driver of the LTC6930 from the V^+ and GND pins on each side of the output pin (Pins 6 and 8). Allowances must be made in the design to provide for output load related supply current spikes, especially in high accuracy applications. A 0.1 μ F ceramic capacitor connected between V^+ and GND (Pins 6 and 8) as close as possible to the device will decouple the rest of the circuit from spikes caused by powering a capacitive output load of up to 50pF. See Figure 1.



Figure 1. Recommended Layout

Switching the DIV Pins

The LTC6930 is designed to quickly and cleanly respond to the digital inputs. The output will respond to the DIV pins within a single clock cycle without introducing any sliver or runt pulses.

Start-Up Time

The start-up time of the LTC6930 is typically 50 μ s from the time that valid power is applied to the first output pulse. The output is held low for the first 50 μ s to prevent any glitches, runt pulses, or invalid frequency output during start-up.

Long-Term Drift

Long-term stability of silicon oscillators is specified in ppm/ $\sqrt{\text{kHr}}$, which is typical of other silicon devices such as operational amplifiers and voltage references. Because drift in silicon-based oscillators is generated primarily by movement of ions in the silicon, most of the drift is accomplished early in the life of the device and the drift can be expected to level off in the long term. The ppm/ $\sqrt{\text{kHr}}$ unit models this time variant decay. Crystal oscillators are often specified with drift measured in ppm/year because their drift mechanism is different. A comparison of various drift rates over a five year time period is shown in Figure 2.

When calculating the amount of drift to be expected, it is important to consider the entire time in the calculation, because the relationship to time is not linear. The drift for

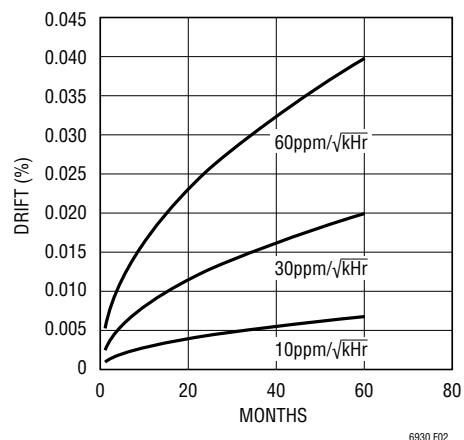

Figure 2. 5 Year Drift at Various Rates

APPLICATIONS INFORMATION

5 years is not 5 times the drift for one year. A sample calculation for drift over 5 years at $30\text{ppm}/\sqrt{\text{kHr}}$ is as follows:

$$5 \text{ years} \cdot 365.25 \text{ days/year} \cdot 24 \text{ hours/day} = 43,830 \text{ hours} = 43.830\text{kHr}$$

$$\sqrt{43.830\text{kHr}} = 6.62\sqrt{\text{kHr}}$$

$$6.62\sqrt{\text{kHr}} \cdot 30\text{ppm}/\sqrt{\text{kHr}} = 0.0198\% \text{ over 5 years.}$$

Drift calculations assume that the part is in continuous operation during the entire time period of the calculation. The movement of ions which results in drift is usually aided by electric fields in the operating parts, and the typical drift spec applies while the part is powered up. Conservative calculations would use a tenth of the drift specification for time when power is not applied to the part.

Setting the Frequency

The output frequency of the LTC6930 is chosen from the values in Table 1 and set using the DIV pins, as noted in the table. Master oscillator frequency is preset in the factory, and the DIV pins select an internal binary divider of up to 128.

For example, if the desired oscillator output frequency is 2.5MHz, finding 2.5MHz in Table 1 shows that the LTC6930-5.00 should be ordered, having a master oscillator frequency of 5MHz, and a DIV value of [001] should be used. This would equate to grounding DIVC and DIVB, while connecting DIVA to the positive supply. Frequencies other than those shown in Table 1 may be requested.

Table 1. Frequency Setting and Available Frequencies

	÷1	÷2	÷4	÷8	÷16	÷32	÷64	÷128
DIV Pin Settings [DIVC][DIVB][DIVA]	000	001	010	011	100	101	110	111
LTC6930-4.19	4.194304MHz	2.097152MHz	1.048576MHz	524.288kHz	262.144kHz	131.072kHz	65.536kHz	32.768kHz
LTC6930-5.00	5.000MHz	2.500MHz	1.250MHz	625.0kHz	312.5kHz	156.25kHz	78.125kHz	39.0625kHz
LTC6930-7.37	7.3728MHz	3.6864MHz	1.8432MHz	921.6kHz	460.8kHz	230.4kHz	115.2kHz	57.6kHz
LTC6930-8.00	8.000MHz	4.000MHz	2.000MHz	1000kHz	500.0kHz	250.0kHz	125.0kHz	62.5kHz
LTC6930-8.19	8.192MHz	4.096MHz	2.048MHz	1024kHz	512.0kHz	256.0kHz	128.0kHz	64.0kHz

PACKAGE DESCRIPTION

MS8 Package
8-Lead Plastic MSOP
 (Reference LTC DWG # 05-08-1660 Rev G)

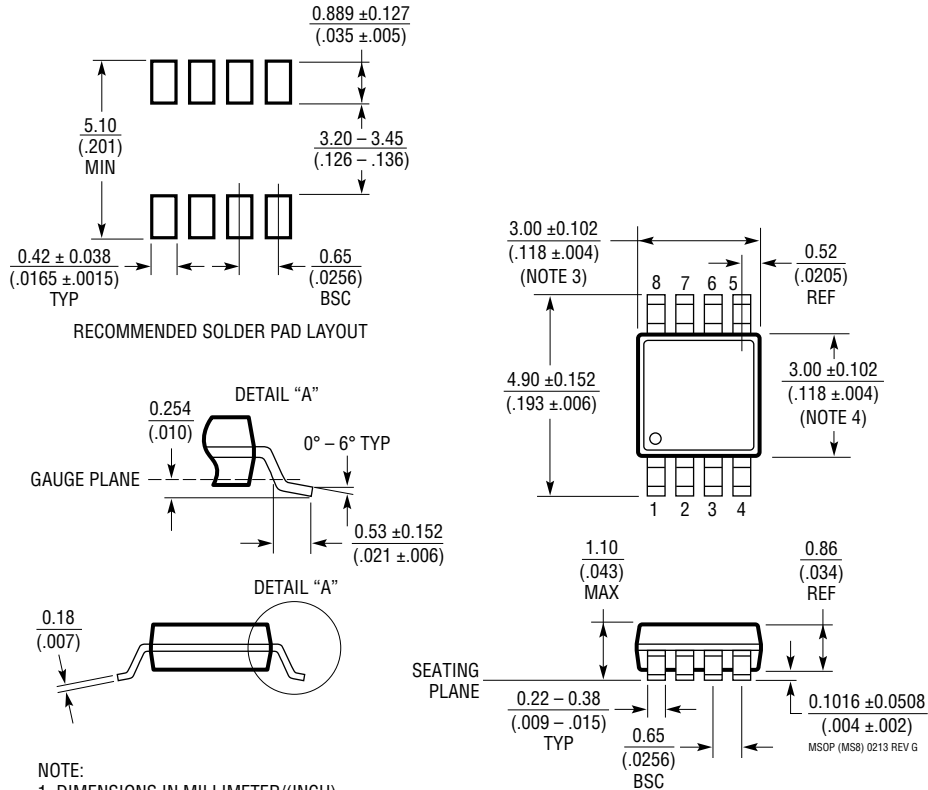

- NOTE:
1. DIMENSIONS IN MILLIMETER/(INCH)
 2. DRAWING NOT TO SCALE
 3. DIMENSION DOES NOT INCLUDE MOLD FLASH, PROTRUSIONS OR GATE BURRS.
MOLD FLASH, PROTRUSIONS OR GATE BURRS SHALL NOT EXCEED 0.152mm (.006") PER SIDE
 4. DIMENSION DOES NOT INCLUDE INTERLEAD FLASH OR PROTRUSIONS.
INTERLEAD FLASH OR PROTRUSIONS SHALL NOT EXCEED 0.152mm (.006") PER SIDE
 5. LEAD COPLANARITY (BOTTOM OF LEADS AFTER FORMING) SHALL BE 0.102mm (.004") MAX

REVISION HISTORY (Revision history begins at Rev C)

REV	DATE	DESCRIPTION	PAGE NUMBER
C	1/11	Revised the option for LTC6930-7.37 under Features.	1
D	2/11	Added LTC6930CMS8-4.19 to the Order Information section.	3
E	5/15	Added MP-Grade	1-3, 5, 6

TYPICAL APPLICATION

Dual, Matched, Digitally Programmable, Lowpass Filter, 2kHz to 256kHz



DIVC, DIVB, DIVA	000	001	010	011	100	101	110	111
f_{CUTOFF}	256kHz	128kHz	64kHz	32kHz	16kHz	8kHz	4kHz	2kHz

RELATED PARTS

PART NUMBER	DESCRIPTION	COMMENTS
LTC1799	1kHz to 33MHz ThinSOT™ Oscillator, Resistor Set	Wide Frequency Range
LTC6900	1kHz to 20MHz ThinSOT Oscillator, Resistor Set	Low Power, Wide Frequency Range
LTC6902	Multiphase Oscillator with Spread Spectrum Modulation	2-, 3- or 4-Phase Outputs
LTC6903/LTC6904	1kHz to 68MHz Serial Port Programmable Oscillator	0.1% Frequency Resolution, I ² C or SPI Interface
LTC6905	17MHz to 170MHz ThinSOT Oscillator, Resistor Set	High Frequency, 100µs Start-Up, 7ps RMS Jitter
LTC6905-XXX	Fixed Frequency ThinSOT Oscillator Family, Up to 133MHz	No Trim Components Required
LTC6906	Micropower 10kHz to 1MHz ThinSOT Oscillator, Resistor Set	12µA Supply Current at 100kHz, 0.65% Frequency Accuracy
LTC6907	Micropower 40kHz to 4MHz ThinSOT Oscillator, Resistor Set	36µA Supply Current at 400kHz, 0.65% Frequency Accuracy
LTC6908	Multiphase Oscillator with Spread Spectrum Modulation	2 Outputs Shifted by Either 180° or 90°
LTC6909	Multiphase Oscillator with Spread Spectrum Modulation	8 Outputs, Configurable Phase Separation from 45° to 120°

Looking for pricing, stock, or lifecycle information?

Click below to explore more details on WIN SOURCE:

- ⊖ [View LTC6930CMS8-8.19#PBF](#) on WIN SOURCE
- ⊖ [Linear Technology](#) Information

Optimize Your Supply Chain with WIN SOURCE Solutions

- ✓ Global Sourcing Solution
- ✓ Obsolete Management
- ✓ Cost Control Management
- ✓ Shortage Management
- ✓ Alternative Solution
- ✓ Excess Inventory Management