



**THE DATASHEET OF  
LTC6906CS6#TRMPBF**



## FEATURES

- **Supply Current: 12µA at 100kHz**
- **<0.65% Frequency Accuracy (from 0°C to 70°C)**
- **Frequency Range: 10kHz to 1MHz**
- **One Resistor Sets the Oscillator Frequency**
- **Single Supply: 2.25V to 5.5V**
- **–40°C to 125°C Operating Temperature Range**
- **No Decoupling Capacitor Needed**
- **Start-Up Time Under 200µs at 1MHz**
- **First Cycle After Power-Up is Accurate**
- **150Ω CMOS Output Driver**
- **Low Profile (1mm) SOT-23 (ThinSOT™) Package**

## APPLICATIONS

- **Low Cost Precision Programmable Oscillator**
- **Rugged, Compact Micropower Replacement for Crystal and Ceramic Oscillators**
- **High Shock and Vibration Environments**
- **Portable and Battery-Powered Equipment**
- **PDA's and Cellular Phones**

LT, LT, LTC, LTM, Linear Technology and the Linear logo are registered trademarks and ThinSOT is a trademark of Linear Technology Corporation. All other trademarks are the property of their respective owners.

## DESCRIPTION

The LTC®6906 is a precision programmable oscillator that is versatile, compact and easy to use. Micropower operation benefits portable and battery-powered equipment. At 100kHz, the LTC6906 consumes 12µA on a 3.3V supply.

A single resistor programs the oscillator frequency over a 10:1 range with better than 0.5% initial accuracy. The output frequency can be divided by 1, 3 or 10 to span a 100:1 total frequency range, 10kHz to 1MHz.

The LTC6906 is easily programmed according to this simple formula:

$$f_{OUT} = \frac{1\text{MHz}}{N} \cdot \left( \frac{100\text{k}}{R_{SET}} \right), \quad N = \begin{cases} 10, & \text{DIV Pin} = V^+ \\ 3, & \text{DIV Pin} = \text{Open} \\ 1, & \text{DIV Pin} = \text{GND} \end{cases}$$

No decoupling capacitor is needed in most cases, yielding an extremely compact solution occupying less than 20mm<sup>2</sup>. Contact LTC Marketing for a version of the part with a shutdown feature or lower frequency operation.

The LTC6906 is available in the 6-lead SOT-23 (ThinSOT) package.

## TYPICAL APPLICATION

### Micropower Clock Generator

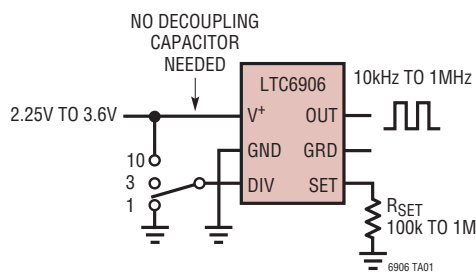

### Typical Supply Current vs Frequency

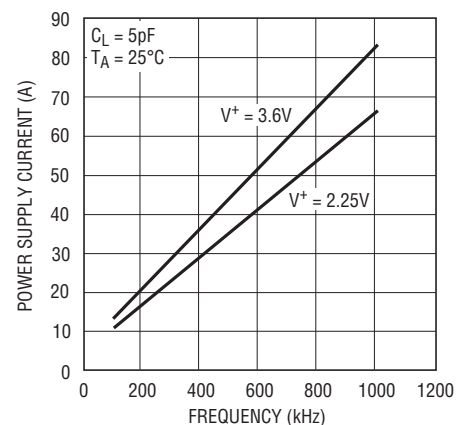

6906 TA01b

# LTC6906

## ABSOLUTE MAXIMUM RATINGS

(Note 1)

V <sup>+</sup> .....	-0.3V to 6V	
DIV to GND .....	-0.3V to (V <sup>+</sup> + 0.3V)	
SET to GND .....	-0.3V to (V <sup>+</sup> + 0.3V)	
GRD to GND .....	-0.3V to (V <sup>+</sup> + 0.3V)	
Operating Temperature Range (Note 7)		
LTC6906C .....	-40°C to 85°C	
LTC6906I .....	-40°C to 85°C	
LTC6906H .....	-40°C to 125°C	
Specified Temperature Range (Note 7)		
LTC6906C .....	0°C to 70°C	
LTC6906I .....	-40°C to 85°C	
LTC6906H .....	-40°C to 125°C	
Storage Temperature Range .....		-65°C to 150°C
Lead Temperature (Soldering, 10 sec) .....		300°C

## PIN CONFIGURATION

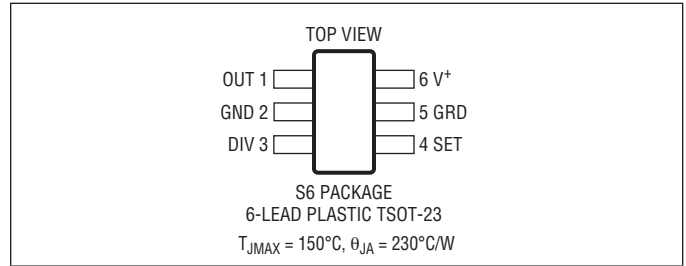

## ORDER INFORMATION

LEAD FREE FINISH	TAPE AND REEL	PART MARKING*	PACKAGE DESCRIPTION	TEMPERATURE RANGE
LTC6906CS6#PBF	LTC6906CS6#TRPBF	LTBJN	6-Lead Plastic TSOT-23	0°C to 70°C
LTC6906IS6#PBF	LTC6906IS6#TRPBF	LTBJN	6-Lead Plastic TSOT-23	-40°C to 85°C
LTC6906HS6#PBF	LTC6906HS6#TRPBF	LTBJN	6-Lead Plastic TSOT-23	-40°C to 125°C
LEAD BASED FINISH	TAPE AND REEL	PART MARKING*	PACKAGE DESCRIPTION	TEMPERATURE RANGE
LTC6906CS6	LTC6906CS6#TR	LTBJN	6-Lead Plastic TSOT-23	0°C to 70°C
LTC6906IS6	LTC6906IS6#TR	LTBJN	6-Lead Plastic TSOT-23	-40°C to 85°C
LTC6906HS6	LTC6906HS6#TR	LTBJN	6-Lead Plastic TSOT-23	-40°C to 125°C

Consult LTC Marketing for parts specified with wider operating temperature ranges. \*The temperature grade is identified by a label on the shipping container.

For more information on lead free part marking, go to: <http://www.linear.com/leadfree/>

For more information on tape and reel specifications, go to: <http://www.linear.com/tapeandreeel/>

## ELECTRICAL CHARACTERISTICS

The ● denotes the specifications which apply over the full operating temperature range, otherwise specifications are at T<sub>A</sub> = 25°C.

SYMBOL	PARAMETER	CONDITIONS		MIN	TYP	MAX	UNITS
Δf	Frequency Accuracy (Notes 2, 3, 9)	V <sup>+</sup> = 2.7V to 3.6V	100kHz ≤ f ≤ 1MHz	●	±0.25	±0.5	%
			100kHz ≤ f ≤ 1MHz, LTC6906C	●		±0.65	%
			100kHz ≤ f ≤ 1MHz, LTC6906I	●		±1.3	%
			f = 1MHz, LTC6906H	●		±1.3	%
			f = 100kHz, LTC6906H	●		±2.2	%
		V <sup>+</sup> = 2.25V	100kHz ≤ f ≤ 1MHz	●	±0.25	±0.7	%
			100kHz ≤ f ≤ 1MHz, LTC6906C	●		±0.85	%
			100kHz ≤ f ≤ 1MHz, LTC6906I	●		±1.3	%
			f = 1MHz, LTC6906H	●		±1.3	%
			f = 100kHz, LTC6906H	●		±2.2	%

6906fc

## ELECTRICAL CHARACTERISTICS

The ● denotes the specifications which apply over the full operating temperature range, otherwise specifications are at  $T_A = 25^\circ\text{C}$ .

SYMBOL	PARAMETER	CONDITIONS	MIN	TYP	MAX	UNITS		
$R_{SET}$	Frequency-Setting Resistor Range		●	100	1000	$k\Omega$		
$\Delta f/\Delta T$	Frequency Drift Over Temp (Note 3)	$R_{SET} = 316k$	●	$\pm 0.005$		$\%/^\circ\text{C}$		
$\Delta f/\Delta V$	Frequency Drift Over Supply (Note 3)	$V^+ = 2.25\text{V to } 3.6\text{V}, 100k \leq R_{SET} \leq 1000k$		0.06		$\%/V$		
	Timing Jitter (Note 4)	Pin 3 = $V^+$ , $100k \leq R_{SET} \leq 1000k$ Pin 3 = Open, $100k \leq R_{SET} \leq 1000k$ Pin 3 = 0V, $100k \leq R_{SET} \leq 1000k$		0.03 0.07 0.15		% % %		
$S_f$	Long-Term Stability of Output Frequency	Pin 3 = $V^+$		300		ppm/ $\sqrt{\text{kHr}}$		
DC	Duty Cycle		●	45	50	55	%	
$V^+$	Operating Supply Range (Note 8)		●	2.25		3.6	V	
$I_S$	Power Supply Current	$R_{SET} = 1000k$ , Pin 3 = 0V, $R_L = 10M$ (DIV = 1, $f_{OUT} = 100kHz$ )	●	$V^+ = 3.6V$ $V^+ = 2.25V$	12.5 10.0	18 15	$\mu A$ $\mu A$	
		$R_{SET} = 100k$ , Pin 3 = 0V, $R_L = 10M$ (DIV = 1, $f_{OUT} = 1MHz$ )	●	$V^+ = 3.6V$ $V^+ = 2.25V$	78 60	100 80	$\mu A$ $\mu A$	
$V_{IH}$	High Level DIV Input Voltage		●	$V^+ = 3.6V$ $V^+ = 2.25V$	3.1 2.05		V V	
$V_{IL}$	Low Level DIV Input Voltage		●	$V^+ = 3.6V$ $V^+ = 2.25V$		0.5 0.2	V V	
$I_{DIV}$	DIV Input Current (Note 5)	Pin 3 = $V^+$ Pin 3 = 0V	●	-2	1	2	$\mu A$ $\mu A$	
$V_{OH}$	High Level Output Voltage (Note 5)	$V^+ = 3.6V$	●	$I_{OH} = -100\mu A$ $I_{OH} = -1mA$	3.40 2.80	3.59 3.30	V V	
		$V^+ = 2.25V$	●	$I_{OH} = -100\mu A$ $I_{OH} = -1mA$	2.15 1.75	2.2 2.0	V V	
$V_{OL}$	Low Level Output Voltage (Note 5)	$V^+ = 3.6V$	●	$I_{OL} = 100\mu A$ $I_{OL} = 1mA$		0.02 0.15	0.2 0.8	V V
		$V^+ = 2.25V$	●	$I_{OL} = 100\mu A$ $I_{OL} = 1mA$		0.03 0.30	0.1 0.5	V V
$t_r$	OUT Rise Time (Note 6)	$V^+ = 3.6V$ $V^+ = 2.25V$			10 25		ns ns	
$t_f$	OUT Fall Time (Note 6)	$V^+ = 3.6V$ $V^+ = 2.25V$			10 25		ns ns	
VGS	GRD Pin Voltage Relative to SET Pin Voltage	$-10\mu A \leq I_{GRD} \leq 0.3\mu A$	●	-10		10	mV	

**Note 1:** Stresses beyond those listed under Absolute Maximum Ratings may cause permanent damage to the device. Exposure to any Absolute Maximum Rating condition for extended periods may affect device reliability and lifetime.

**Note 2:** Some frequencies may be generated using two different values of  $R_{SET}$ . For these frequencies, the error is specified assuming that the larger value of  $R_{SET}$  is used.

**Note 3:** Frequency accuracy is defined as the deviation from the  $f_{OUT}$  equation.

**Note 4:** Jitter is the ratio of the peak-to-peak deviation of the period to the mean of the period. This specification is based on characterization and is not 100% tested.

**Note 5:** Current into a pin is given as a positive value. Current out of a pin is given as a negative value.

**Note 6:** Output rise and fall times are measured between the 10% and 90% power supply levels.

**Note 7:** The LTC6906C is guaranteed to meet specified performance from  $0^\circ\text{C}$  to  $70^\circ\text{C}$ . The LTC6906C is designed, characterized and expected to meet specified performance from  $-40^\circ\text{C}$  to  $85^\circ\text{C}$  but is not tested or QA sampled at these temperatures. The LTC6906I is guaranteed to meet specified performance from  $-40^\circ\text{C}$  to  $85^\circ\text{C}$ .

**Note 8:** Consult the Applications Information section for operation with supplies higher than 3.6V.

**Note 9:** Test conditions reflect the master oscillator frequency. The output divider is functionally tested and divided frequency accuracy is guaranteed by design.

TYPICAL PERFORMANCE CHARACTERISTICS

Typical Frequency Error vs Power Supply

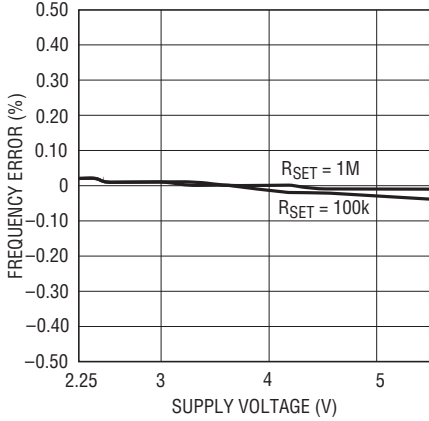

6906 G01

Typical Frequency Error vs Temperature

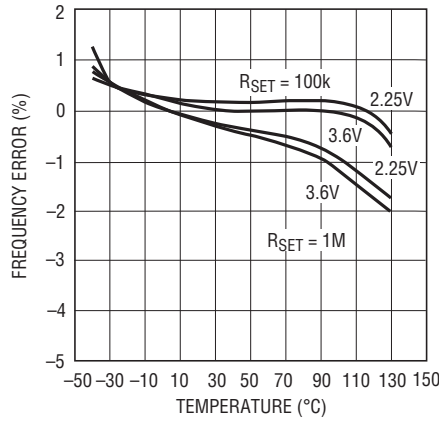

6906 G02

Typical Frequency Error vs RSET

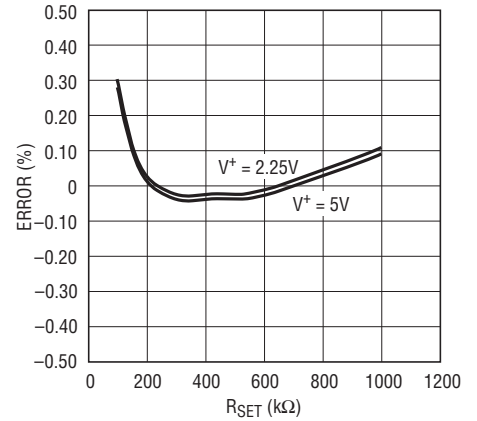

6906 G03

Typical Supply Current vs Frequency

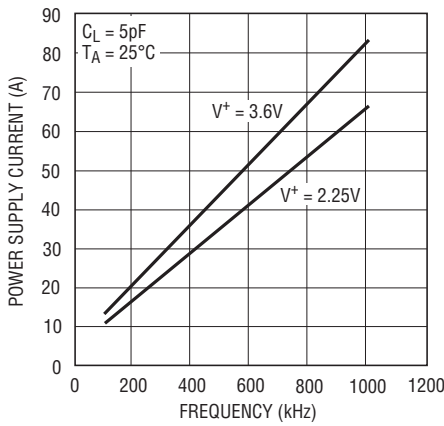

6906 G04

Typical Supply Current vs Load Capacitance

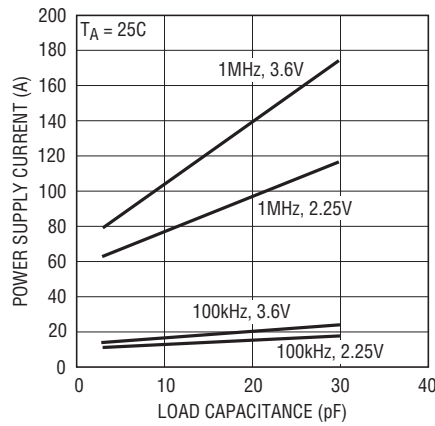

6906 G05

VSET vs Temperature (VSET is the Voltage Measured at the RSET Pin)

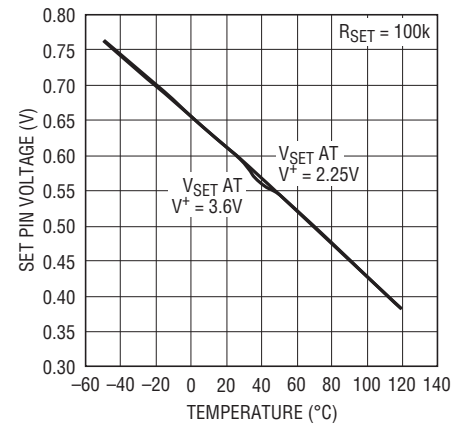

6906 G06

Typical Supply Current vs Temperature, 1MHz

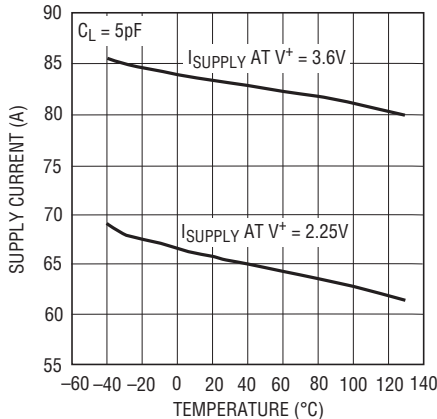

6906 G07

Typical Supply Current vs Temperature, 100kHz

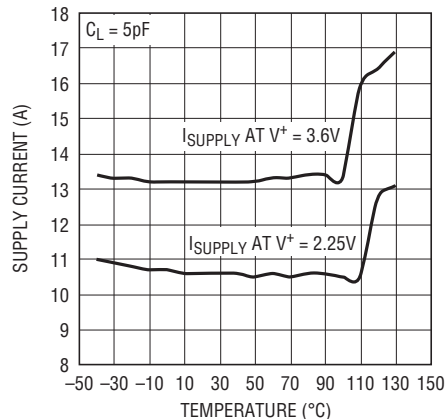

6906 G08

## PIN FUNCTIONS

**OUT (Pin 1):** Oscillator Output. The OUT pin swings from GND to  $V^+$  with an output resistance of approximately  $150\Omega$ . For micropower operation, the load resistance must be kept as high as possible and the load capacitance as low as possible.

**GND (Pin 2):** Ground.

**DIV (Pin 3):** Divider Setting Input. This three-level input selects one of three internal digital divider settings, determining the value of  $N$  in the frequency equation. Tie to GND for  $\div 1$ , leave floating for  $\div 3$  and tie to  $V^+$  for  $\div 10$ . When left floating, the LTC6906 pulls Pin 3 to mid-supply with a  $2.5M$  resistor. When Pin 3 is floating, care should be taken to reduce coupling from the OUT pin and its trace to Pin 3. Coupling can be reduced by increasing the physical space between traces or by shielding the DIV pin with grounded metal.

**SET (Pin 4):** Frequency Setting Resistor Input. Connect a resistor,  $R_{SET}$ , from this pin to GND to set the oscillator frequency. For best performance use a precision metal- or thin-film resistor of  $0.5\%$  or better tolerance and  $50\text{ppm}/^\circ\text{C}$

or better temperature coefficient. For lower accuracy applications, an inexpensive  $1\%$  thick-film resistor may be used. Limit the capacitance in parallel with  $R_{SET}$  to less than  $10\text{pF}$  to reduce jitter and to ensure stability. Capacitance greater than  $10\text{pF}$  could cause the LTC6906 internal feedback circuits to oscillate. The voltage on the SET pin is approximately  $650\text{mV}$  and decreases with temperature by about  $-2.2\text{mV}/^\circ\text{C}$ .

**GRD (Pin 5):** Guard Signal. This pin can be used to reduce PC board leakage across the frequency setting resistor,  $R_{SET}$ . The GRD pin is held within a few millivolts of the SET pin and shunts leakage current away from the SET pin. To control leakage, connect a bare copper trace (a trace with no solder mask) to GRD and loop it around the SET pin and all PC board metal connected to SET.

**$V^+$  (Pin 6):** Voltage Supply ( $2.25\text{V}$  to  $3.6\text{V}$ ). This supply is internally decoupled with a  $20\Omega$  resistor in series with an  $800\text{pF}$  capacitor. No external decoupling capacitor is required for OUT pin loads less than  $50\text{pF}$ .  $V^+$  should be kept reasonably free of noise and ripple.

## BLOCK DIAGRAM

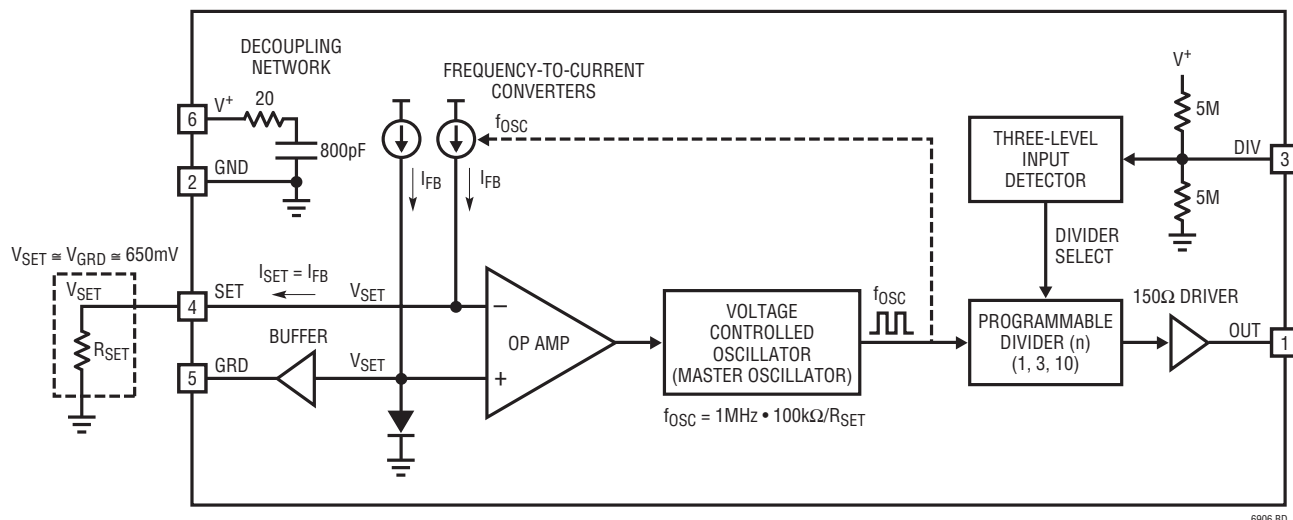

TEST CIRCUIT

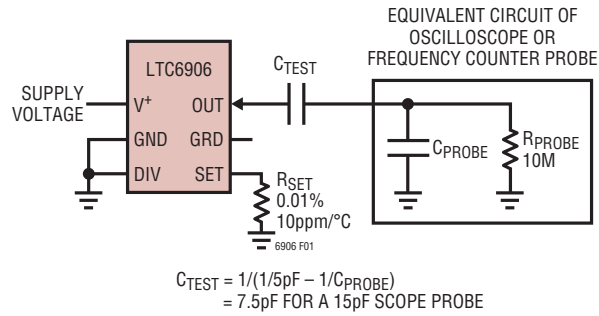

Figure 1. Test Circuit with 5pF Effective Load

EQUIVALENT INPUT AND OUTPUT CIRCUITS

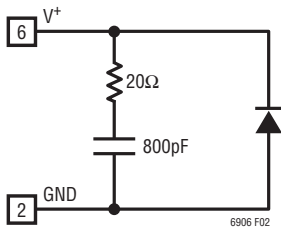

Figure 2. V+ Pin

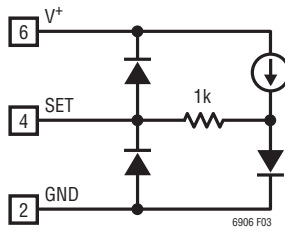

Figure 3. SET Pin

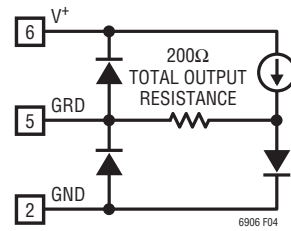

Figure 4. GRD Pin

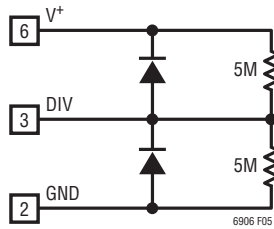

Figure 5. DIV Pin

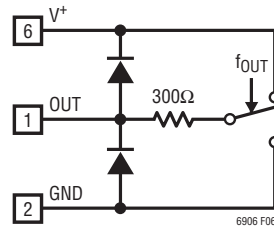

Figure 6. OUT Pin

## THEORY OF OPERATION

The LTC6906 is a precision, resistor programmable oscillator (see the Block Diagram). It generates a square wave at the OUT pin with a period directly proportional to the value of an external resistor,  $R_{SET}$ . A feedback circuit measures and controls the oscillator frequency to achieve the highest possible accuracy. In equilibrium, this circuit ensures that the current in the SET pin,  $I_{SET}$ , is balanced by  $I_{FB}$ .  $I_{FB}$  is proportional to the master oscillator frequency, so we have the relationship:

$$I_{SET} = I_{FB} = V_{SET} \cdot f_{OSC} \cdot C_{OSC} \quad (1)$$

where  $C_{OSC}$  is a precision internal capacitor:

$$C_{OSC} = 10\text{pF for the LTC6906}$$

Solving for the oscillator period:

$$t_{OSC} = \frac{1}{f_{OSC}} = \frac{V_{SET}}{I_{SET}} \cdot C_{OSC} \quad (2)$$

This is the fundamental equation for the LTC6906. It holds regardless of how the SET pin is driven. When a resistor,  $R_{SET}$ , is connected from the SET pin to ground, we have the relationship:

$$\frac{V_{SET}}{I_{SET}} = R_{SET} \quad (3)$$

so

$$t_{OSC} = \frac{1}{f_{OSC}} = R_{SET} \cdot C_{OSC} \quad (4)$$

The period and frequency are determined exclusively by  $R_{SET}$  and the precision internal capacitor. Importantly, the value of  $V_{SET}$  is immaterial, and the LTC6906 maintains its accuracy even though  $V_{SET}$  is not a precision reference voltage.

The digital dividers shown in the Block Diagram further divide the master oscillator frequency by 1, 3 or 10 producing:

$$f_{OUT} = \frac{f_{OSC}}{N} \quad (5)$$

and

$$t_{OUT} = N \cdot t_{OSC} \quad (6)$$

Table 1 gives specific frequency and period equations for the LTC6906. The Applications Information section gives further detail and discusses alternative ways of setting the LTC6906 output frequency.

**Table 1. Output Frequency Equations**

PART NUMBER	FREQUENCY	PERIOD	DIVIDER RATIOS
LTC6906	$f_{OUT} = \frac{1\text{MHz}}{N} \cdot \left(\frac{100\text{k}}{R_{SET}}\right)$	$t_{OUT} = N \cdot 1\mu\text{s} \cdot \left(\frac{R_{SET}}{100\text{k}}\right)$	$N = \begin{cases} 10, & \text{DIV Pin} = V^+ \\ 3, & \text{DIV Pin} = \text{Open} \\ 1, & \text{DIV Pin} = \text{GND} \end{cases}$

## APPLICATIONS INFORMATION

### Selecting $R_{SET}$ and the Divider Ratio

The LTC6906 contains a master oscillator followed by a digital divider (see the Block Diagram).  $R_{SET}$  determines the master oscillator frequency and the DIV pin sets the divider ratio, N. The range of frequencies accessible in each divider ratio overlap, as shown in Figure 7. This figure is derived from the equations in Table 1. **For any given frequency, power can be minimized by minimizing the master oscillator frequency. This implies maximizing  $R_{SET}$  and using the lowest possible divider ratio, N.** The relationship between  $R_{SET}$ , N and the unloaded power consumption is shown in Figure 8, where we can clearly see that supply current decreases for large values of  $R_{SET}$ . For a discussion of jitter and divide ratio, refer to page 11.

### Minimizing Power Consumption

The supply current of the LTC6906 has four current components:

- Constant (Independent  $V^+$ ,  $f_{OUT}$  and  $C_{LOAD}$ )
- Proportional to  $I_{SET}$  (which is the current in  $R_{SET}$ )
- Proportional to  $V^+$ ,  $f_{OUT}$  and  $C_{LOAD}$
- Proportional to  $V^+$  and  $R_{LOAD}$

An approximate expression for the total supply current is:

$$I^+ \cong 5\mu A + 6 \cdot I_{SET} + V^+ \cdot f_{OUT} \cdot (C_{LOAD} + 5pF) + \frac{V^+}{2 \cdot R_{LOAD}}$$

$$\cong 5\mu A + 6 \cdot \frac{V_{SET}}{R_{SET}} + V^+ \cdot f_{OUT} \cdot (C_{LOAD} + 5pF) + \frac{V^+}{2 \cdot R_{LOAD}}$$

$V_{SET}$  is approximately 650mV at 25°C, but varies with temperature. This behavior is shown in the Typical Performance Characteristics section.

Power can be minimized by maximizing  $R_{SET}$ , minimizing the load on the OUT pin and operating at lower frequencies. Figure 9 shows total supply current vs frequency under typical conditions. Below 100kHz the load current is negligible for the 5pF load shown.

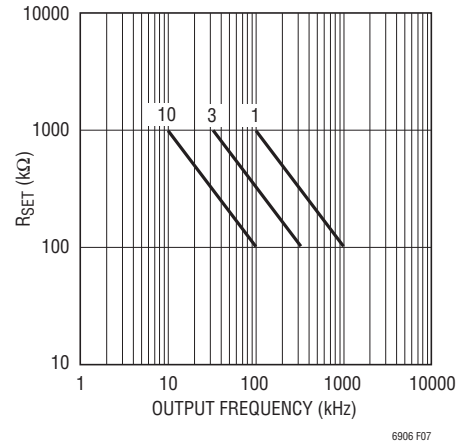

Figure 7.  $R_{SET}$  vs Desired Output Frequency (LTC6906)

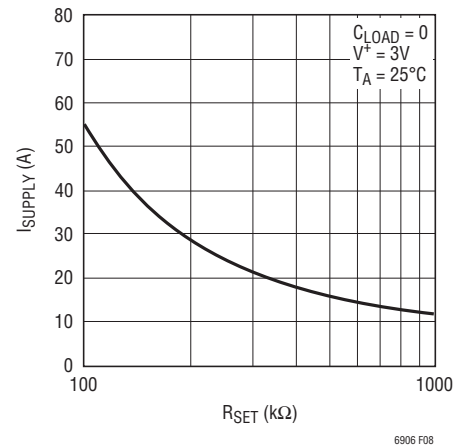

Figure 8. Unloaded Supply Current vs  $R_{SET}$

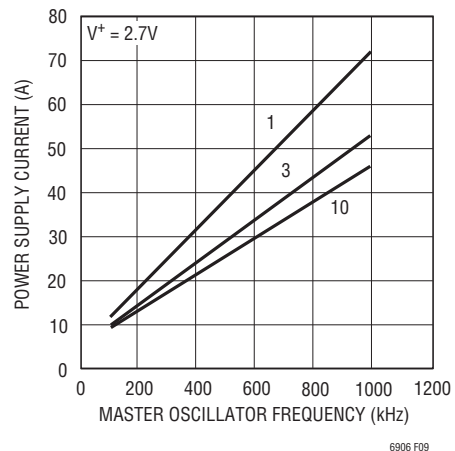

Figure 9. Supply Current vs Frequency

## APPLICATIONS INFORMATION

### Guarding Against PC Board Leakage

The LTC6906 uses relatively large resistance values for  $R_{SET}$  to minimize power consumption. For  $R_{SET} = 1M$ , the SET pin current is typically only  $0.65\mu A$ . Thus, only  $0.65nA$  leaking into the SET pin causes a 0.1% frequency error. Similarly,  $1G$  of leakage resistance across  $R_{SET}$  ( $1000 \cdot R_{SET}$ ) causes the same 0.1% error.

Achieving the highest accuracy requires controlling potential leakage paths. PC board leakage is aggravated by both dirt and moisture. Effective cleaning is a good first step to minimizing leakage, and some PC board manufacturers offer high impedance or low leakage processing options.

Another effective method for controlling leakage is to shunt the leakage current away from the sensitive node through a low impedance path. The LTC6906 provides a signal on the GRD pin for this purpose. Figure 10 shows a PC board layout that uses the GRD pin and a “guard ring” to absorb leakage currents. The guard ring surrounds the SET pin and the end of  $R_{SET}$  to which it is connected. The guard ring must have no solder mask covering it to be effective. The GRD pin voltage is held within a few millivolts of the SET pin voltage, so any leakage path between the SET pin and the guard ring generates no leakage current.

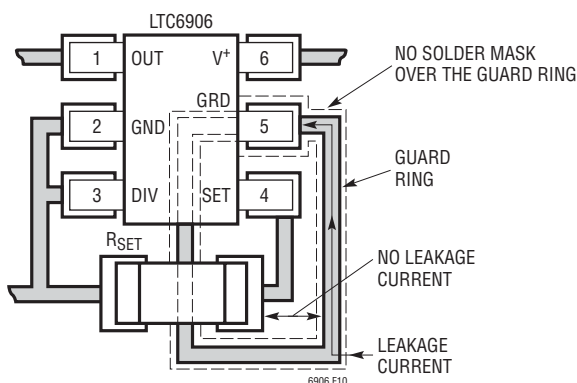

Figure 10. PC Board Layout with Guard Ring

### Bypassing the Power Supply

The LTC6906 has on-chip power supply decoupling that eliminates the need for an external decoupling capacitor in most cases. Figure 11 shows a simplified equivalent circuit of the output driver and on-chip decoupling network. When the output driver switches from low to high, the  $800pF$  capacitor delivers the current needed to charge the off-chip capacitive load. Within nanoseconds the system power supply recharges the  $800pF$  capacitor.

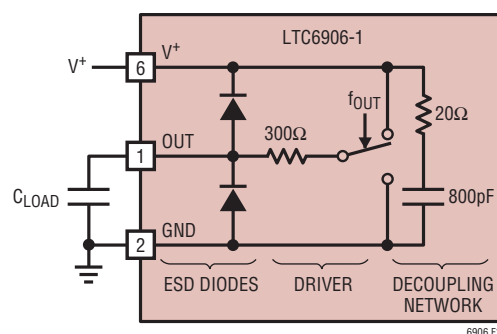

Figure 11. Simplified Equivalent of the Output Driver and On-Chip Decoupling Circuit

Figure 12 shows a test circuit for evaluating performance of the LTC6906 with a highly inductive,  $330nH$  power supply. Figure 13 shows the effectiveness of the on-chip decoupling network. For  $C_{LOAD} = 5pF$  to  $50pF$ , the output waveforms remain well formed.

The extremely low supply current of the LTC6906 allows operation with substantial resistance in the power supply. Figure 14 shows a test circuit for evaluating performance of the LTC6906 with a highly resistive,  $100\Omega$  power supply. Figure 15 shows the effectiveness of the on-chip decoupling network. For  $C_{LOAD} = 5pF$  to  $50pF$ , the output waveforms remain well formed. With a  $50pF$  load, a very small (2.5%) slow tail can be seen on the rising edge. The output waveform is still well formed even in this case. The ability of the LTC6906 to operate with a resistive supply permits supplying power via a CMOS logic gate or microcontroller pin. Since the LTC6906 has a turn-on time of less than  $200\mu s$ , this technique can be used to enable the device only when needed and further reduce power consumption.

APPLICATIONS INFORMATION

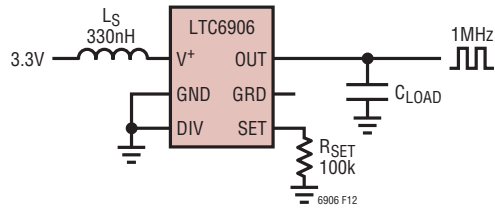

Figure 12. Test Circuit with an Inductive Power Supply

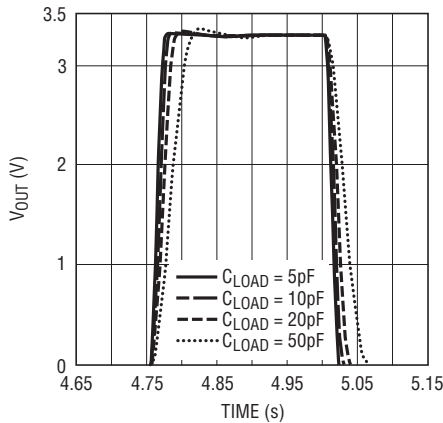

Figure 13. Output Waveforms with an Inductive Supply (See Figure 12)

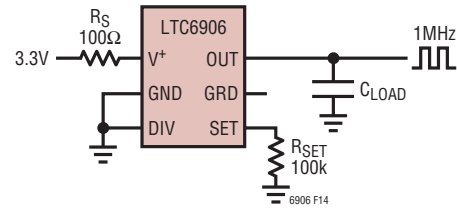

Figure 14. Test Circuit with a Resistive Power Supply

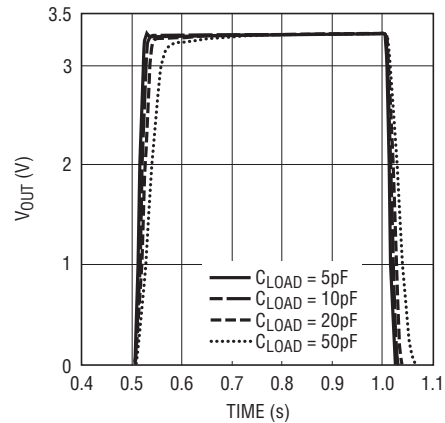

Figure 15. Output Waveforms with a Resistive Supply (See Figure 14)

Start-Up Time

When the LTC6906 is powered up, it holds the OUT pin low. After the master oscillator has settled, the OUT pin is enabled and the first output cycle is guaranteed to be within specification. The time from power-up to the first output transition is given approximately by:

$$t_{START} \approx 64 \cdot t_{OSC} + 100\mu s$$

The digital divider ratio, N, does not affect the start-up time.

Power Supply Rejection

The LTC6906 has a very low supply voltage coefficient, meaning that the output frequency is nearly insensitive to the DC power supply voltage. In most cases, this error term can be neglected.

High frequency noise on the power supply (V+) pin has the potential to interfere with the LTC6906's master oscillator. Periodic noise, such as that generated by a switching power supply, can shift the output frequency or increase

jitter. The risk increases when the fundamental frequency or harmonics of the noise fall near the master oscillator frequency. It is relatively easy to filter the LTC6906 power supply because of the very low supply current. For example, an RC filter with R = 160Ω and C = 10μF provides a 100Hz lowpass filter while dropping the supply voltage only about 10mV.

Operating the LTC6906 with Supplies Higher Than 3.6V

The LTC6906 may also be used with supply voltages between 3.6V and 5.5V under very specific conditions. To ensure proper functioning above 3.6V, a filter circuit must be attached to the power supply and located within 1cm of the device. A simple RC filter consisting of a 100Ω resistor and 1μF capacitor (Figure 16) will ensure that supply resonance at higher supply voltages does not induce unpredictable oscillator behavior. Accuracy under higher supplies may be estimated from the typical Frequency vs Supply Voltage curves in the Typical Performance Characteristics section of this data sheet.

## APPLICATIONS INFORMATION

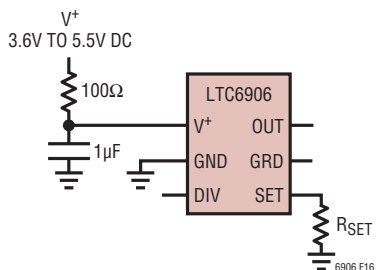

Figure 16. Using the LTC6906 at Higher Supply Voltages

### Alternative Methods for Setting the Output Frequency

Any means of sinking current from the SET pin will control the output frequency of the LTC6906. Equation 2 (repeated below) gives the fundamental relationship between frequency and the SET pin voltage and current:

$$t_{\text{OSC}} = \frac{1}{f_{\text{OSC}}} = \frac{V_{\text{SET}}}{I_{\text{SET}}} \cdot 10\text{pF} \quad (2)$$

This equation shows that the LTC6906 converts conductance ( $I_{\text{SET}}/V_{\text{SET}}$ ) to frequency or, equivalently, converts resistance ( $R_{\text{SET}} = V_{\text{SET}}/I_{\text{SET}}$ ) to period.

$V_{\text{SET}}$  is the voltage across an internal diode, and as such it is given approximately by:

$$\begin{aligned} V_{\text{SET}} &\cong V_T \cdot \text{Log}_e \frac{I_{\text{SET}}}{I_S} \\ &\cong 25.9\text{mV} \cdot \text{Log}_e \left( \frac{I_{\text{SET}}}{82 \cdot 10^{-18}\text{A}} \right) - 2.3\text{mV}/^\circ\text{C} \end{aligned}$$

where

$$V_T = kT/q = 25.9\text{mV at } T = 300^\circ\text{K (27}^\circ\text{C)}$$

$$I_S \cong 82 \cdot 10^{-18}\text{Amps}$$

( $I_S$  is also temperature dependent)

$V_{\text{SET}}$  varies with temperature and the SET pin current. The response of  $V_{\text{SET}}$  to temperature is shown in the Typical Performance graphs.  $V_{\text{SET}}$  changes approximately  $-2.3\text{mV}/^\circ\text{C}$ . At room temperature  $V_{\text{SET}}$  increases  $18\text{mV}/\text{octave}$  or  $60\text{mV}/\text{decade}$  of increase in  $I_{\text{SET}}$ .

If the SET pin is driven with a current source generating  $I_{\text{SET}}$ , the oscillator output frequency will be:

$$f_{\text{OSC}} \cong \frac{\frac{I_{\text{SET}}}{10\text{pF}}}{25.9\text{mV} \cdot \ln \left( \frac{I_{\text{SET}}}{82 \cdot 10^{-18}\text{A}} \right) - 2.3\text{mV}/^\circ\text{C}}$$

Figure 17 and Figure 18 show a current controlled oscillator and a voltage controlled oscillator. These circuits are not highly accurate if used alone, but can be very useful if they are enclosed in an overall feedback circuit such as a phase-locked loop.

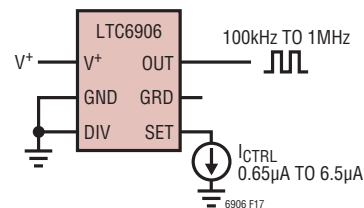

Figure 17. Current Controlled Oscillator

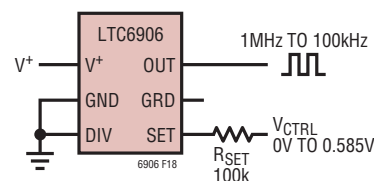

Figure 18. Voltage Controlled Oscillator

### Jitter and Divide Ratio

At a given output frequency, a higher master oscillator frequency and a higher divide ratio will result in lower jitter and higher power supply dissipation. Indeterminate jitter percentage will decrease by a factor of slightly less than the square root of the divider ratio, while determinate jitter will not be similarly attenuated. Please consult the specification tables for typical jitter at various divider ratios.

## TYPICAL APPLICATIONS

### Setting Frequency to 0.1% Resolution with Standard Resistors

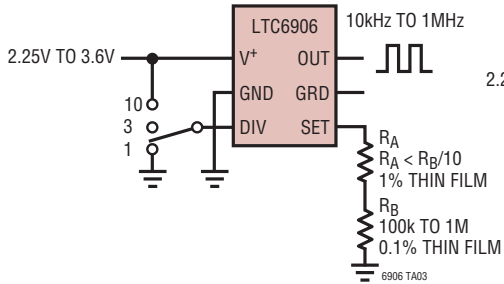

### Trimming the Frequency

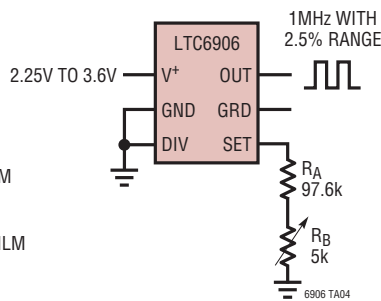

### Sine Wave Oscillator

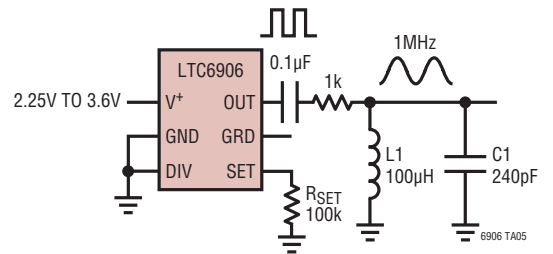

## PACKAGE DESCRIPTION

Please refer to <http://www.linear.com/designtools/packaging/> for the most recent package drawings.

### S6 Package 6-Lead Plastic TSOT-23

(Reference LTC DWG # 05-08-1636 Rev B)

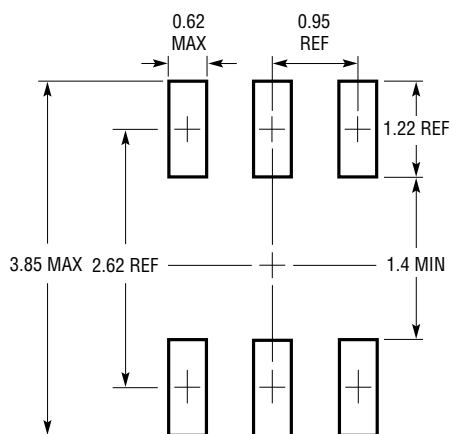

RECOMMENDED SOLDER PAD LAYOUT  
PER IPC CALCULATOR

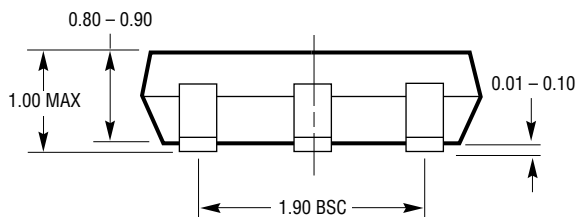
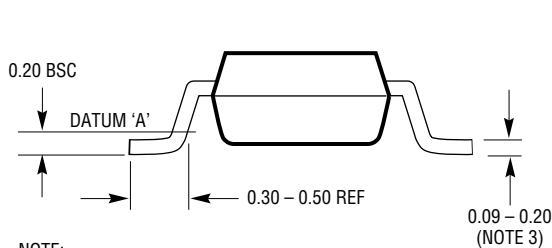
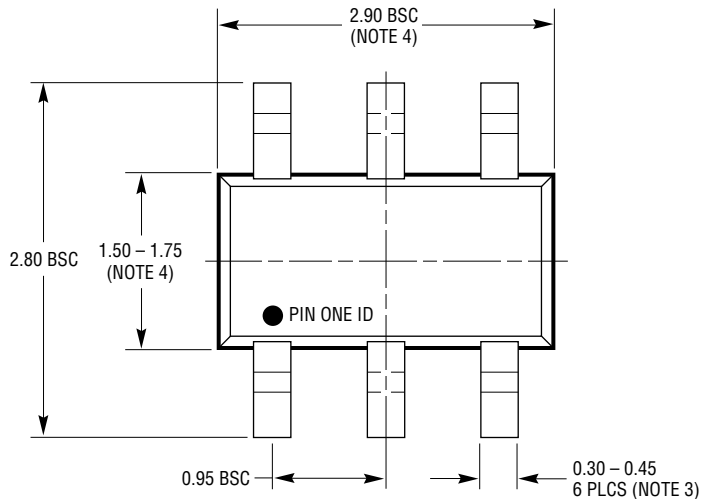

S6 TSOT-23 0302 REV B

- NOTE:
1. DIMENSIONS ARE IN MILLIMETERS
  2. DRAWING NOT TO SCALE
  3. DIMENSIONS ARE INCLUSIVE OF PLATING
  4. DIMENSIONS ARE EXCLUSIVE OF MOLD FLASH AND METAL BURR
  5. MOLD FLASH SHALL NOT EXCEED 0.254mm
  6. JEDEC PACKAGE REFERENCE IS MO-193

**REVISION HISTORY** (Revision history begins at Rev B)

REV	DATE	DESCRIPTION	PAGE NUMBER
B	12/10	Added Note 9. Revised values in the Guarding Against PC Board Leakage section.	2-3 9
C	11/11	Reinsert symbols missing from Rev B	1, 4, 5, 6, 8, 9, 10, 11, 12

## RELATED PARTS

PART NUMBER	DESCRIPTION	COMMENTS
LTC1799	1kHz to 33MHz ThinSOT Oscillator	Single Output, Greater Frequency Range
LTC6900	1kHz to 20MHz ThinSOT Oscillator	Single Output, Greater Frequency Range
LTC6902	Multiphase Oscillator with Spread Spectrum Frequency Modulation	2-, 3- or 4-Phase Outputs
LTC6903/LTC6904	1kHz to 68MHz Serial Port Programmable Oscillator	Very Wide Frequency Range with Digital Programmability
LTC6905	17MHz to 170MHz ThinSOT Oscillator	Single Output, Higher Frequency

## Looking for pricing, stock, or lifecycle information?

Click below to explore more details on WIN SOURCE:

 [View LTC6906CS6#TRMPBF on WIN SOURCE](#)

 [Linear Technology](#) Information

## Optimize Your Supply Chain with WIN SOURCE Solutions

-  Global Sourcing Solution
-  Obsolete Management
-  Cost Control Management
-  Shortage Management
-  Alternative Solution
-  Excess Inventory Management