



**THE DATASHEET OF  
LTC4002EDD-8.4#PBF**



## FEATURES

- **Wide Input Supply Range:**  
 4.7V to 22V – 4.2 Version  
 8.9V to 22V – 8.4 Version
- **High Efficiency Current Mode PWM Controller with 500kHz Switching Frequency**
- **±1% Charge Voltage Accuracy**
- **End-of-Charge Current Detection Output**
- **3 Hour Charge Termination Timer**
- Constant Switching Frequency for Minimum Noise
- ±5% Charge Current Accuracy
- Low 10 $\mu$ A Reverse Battery Drain Current
- Automatic Battery Recharge
- Automatic Shutdown When Input Supply is Removed
- Automatic Trickle Charging of Low Voltage Batteries
- Battery Temperature Sensing and Charge Qualification
- Stable with Ceramic Output Capacitor
- 8-Lead SO and 10-Lead DFN Packages

## APPLICATIONS

- Portable Computers
- Charging Docks
- Handheld Instruments

## DESCRIPTION

The LTC<sup>®</sup>4002 is a complete battery charger controller for one (4.2V) or two (8.4V) cell lithium-ion batteries. With a 500kHz switching frequency, the LTC4002 provides a small, simple and efficient solution to fast charge Li-Ion batteries from a wide range of supply voltages. An external sense resistor sets the charge current with  $\pm 5\%$  accuracy. An internal resistor divider and precision reference set the final float voltage to 4.2V per cell with  $\pm 1\%$  accuracy.

When the input supply is removed, the LTC4002 automatically enters a low current sleep mode, dropping the battery drain current to 10 $\mu$ A. An internal comparator detects the near end-of-charge condition while an internal timer sets the total charge time and terminates the charge cycle. After the charge cycle ends, if the battery voltage drops below 4.05V per cell, a new charge cycle will automatically begin.

The LTC4002 is available in the 8-lead SO and 10-lead DFN packages.

LT, LTC and LT are registered trademarks of Linear Technology Corporation. All other trademarks are the property of their respective owners.

## TYPICAL APPLICATION

1.5A Single Cell Li-Ion Battery Charger

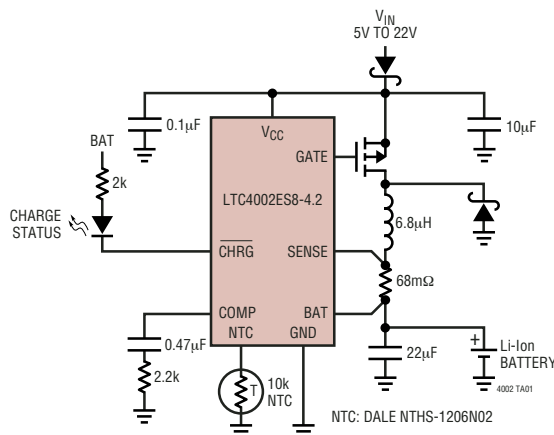

Efficiency vs Input Voltage

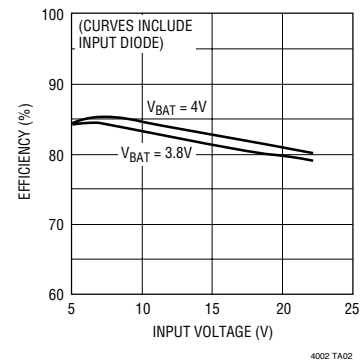

# LTC4002

## ABSOLUTE MAXIMUM RATINGS (Note 1)

Supply Voltage ( $V_{CC}$ ) .....	24V	Operating Temperature Range (Note 4) ..	-40°C to 85°C
GATE .....	( $V_{CC} - 8V$ ) to $V_{CC}$	Storage Temperature Range .....	-65°C to 125°C
BAT, SENSE .....	-0.3V to 14V	Lead Temperature (S8 Package)	
CHRG, NTC .....	-0.3V to 8V	(Soldering, 10 sec) .....	300°C

## PACKAGE/ORDER INFORMATION

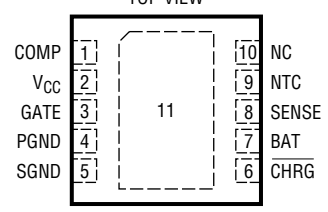
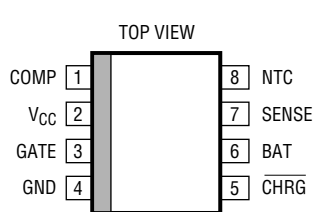
 <p>DD PACKAGE 10-LEAD (3mm x 3mm) PLASTIC DFN <math>T_{JMAX} = 125^{\circ}C</math>, <math>\theta_{JA} = 43^{\circ}C/W</math> EXPOSED PAD IS GND (PIN 11) MUST BE SOLDERED TO PCB</p>	ORDER PART NUMBER	 <p>S8 PACKAGE 8-LEAD PLASTIC SO <math>T_{JMAX} = 125^{\circ}C</math>, <math>\theta_{JA} = 110^{\circ}C/W</math></p>	ORDER PART NUMBER
	LTC4002EDD-4.2 LTC4002EDD-8.4		LTC4002ES8-4.2 LTC4002ES8-8.4
	DD PART MARKING		S8 PART MARKING
	LAGG LBGY		400242 400284

Consult LTC Marketing for parts specified with wider operating temperature ranges.

## ELECTRICAL CHARACTERISTICS (LTC4002-4.2) The ● denotes the specifications which apply over the full operating temperature range, otherwise specifications are at $T_A = 25^{\circ}C$ . $V_{CC} = 10V$ unless otherwise noted.

SYMBOL	PARAMETER	CONDITIONS	MIN	TYP	MAX	UNITS	
$V_{CC}$	$V_{CC}$ Supply Voltage		● 4.7		22	V	
$I_{CC}$	$V_{CC}$ Supply Current	Current Mode		3	5	mA	
		Shutdown Mode		3	5	mA	
		Sleep Mode		10	20	$\mu A$	
$V_{BAT(FLT)}$	Battery Regulated Float Voltage	$5V \leq V_{CC} \leq 22V$ (Note 2)	● 4.168	4.2	4.232	V	
			● 4.158		4.242	V	
$V_{SNS(CHG)}$	Constant Current Sense Voltage	$3V \leq V_{BAT} \leq 4V$ (Note 3) $0^{\circ}C \leq T_A \leq 85^{\circ}C$ $-40^{\circ}C \leq T_A \leq 85^{\circ}C$	● 93	100	107	mV	
			● 90		110	mV	
$V_{SNS(TRKL)}$	Trickle Current Sense Voltage	$V_{BAT} = 0V$ (Note 3)		5	10	15	mV
$V_{TRKL}$	Trickle Charge Threshold Voltage	$V_{BAT}$ Rising		2.75	2.9	3.05	V
$V_{UV}$	$V_{CC}$ Undervoltage Lockout Threshold Voltage	$V_{CC}$ Rising		3.9	4.2	4.5	V
$\Delta V_{UV}$	$V_{CC}$ Undervoltage Lockout Hysteresis Voltage			200		mV	
$V_{MSD}$	Manual Shutdown Threshold Voltage	COMP Pin Falling		200	360	500	mV
$V_{ASD}$	Automatic Shutdown Threshold Voltage	$V_{CC} - V_{BAT}$		250		mV	
$I_{COMP}$	COMP Pin Output Current	$V_{COMP} = 1.2V$		100		$\mu A$	
$I_{CHRG}$	CHRG Pin Weak Pull-Down Current	$V_{CHRG} = 1V$		15	25	35	$\mu A$
$V_{CHRG}$	CHRG Pin Output Low Voltage	$I_{CHRG} = 1mA$		0.15	0.3	V	
$R_{EOC}$	End-of-Charge Ratio	$V_{SNS(EOC)} / V_{SNS(CHG)}$		10	25	32	%
$t_{TIMER}$	Charge Time Accuracy				10	%	

4002f

## ELECTRICAL CHARACTERISTICS (LTC4002-4.2) The ● denotes the specifications which apply over the full operating temperature range, otherwise specifications are at $T_A = 25^\circ\text{C}$ . $V_{CC} = 10\text{V}$ unless otherwise noted.

SYMBOL	PARAMETER	CONDITIONS	MIN	TYP	MAX	UNITS
$I_{NTC}$	NTC Pin Output Current	$V_{NTC} = 0.85\text{V}$	● 75	85	95	$\mu\text{A}$
$V_{NTC-HOT}$	NTC Pin Threshold Voltage (Hot)	$V_{NTC}$ Falling Hysteresis	● 340	355 25	370	mV mV
$V_{NTC-COLD}$	NTC Pin Threshold Voltage (Cold)	$V_{NTC}$ Rising Hysteresis	● 2.428	2.465 170	2.502	V mV
$\Delta V_{RECHRG}$	Recharge Battery Voltage Offset from Full Charged Battery Voltage	$V_{BAT(FULLCHARGED)} - V_{RECHRG}$ , $V_{BAT}$ Falling	100	150	200	mV
$I_{LEAK}$	CHRG Pin Leakage Current	$V_{CHRG} = 8\text{V}$ , Charging Stops			1	$\mu\text{A}$

### Oscillator

$f_{OSC}$	Switching Frequency		450	500	550	kHz
DC	Maximum Duty Cycle				100	%

### Gate Drive

$t_r$	Rise Time	$C_{GATE} = 2000\text{pF}$ , 10% to 90%		20		ns
$t_f$	Fall Time	$C_{GATE} = 2000\text{pF}$ , 90% to 10%		50		ns
$\Delta V_{GATE}$	Output Clamp Voltage	$V_{CC} - V_{GATE}$ , $V_{CC} \geq 9\text{V}$	●		8	V
$\Delta V_{GATEHI}$	Output High Voltage	$\Delta V_{GATEHI} = V_{CC} - V_{GATE}$ , $V_{CC} \geq 7\text{V}$	●		0.3	V
$\Delta V_{GATELO}$	Output Low Voltage	$\Delta V_{GATELO} = V_{CC} - V_{GATE}$ , $V_{CC} \geq 7\text{V}$	●	4.5		V

(LTC4002-8.4) The ● denotes the specifications which apply over the full operating temperature range, otherwise specifications are at  $T_A = 25^\circ\text{C}$ .  $V_{CC} = 12\text{V}$  unless otherwise noted.

SYMBOL	PARAMETER	CONDITIONS	MIN	TYP	MAX	UNITS	
<b>DC Characteristics</b>							
$V_{CC}$	$V_{CC}$ Supply Voltage		● 8.9		22	V	
$I_{CC}$	$V_{CC}$ Supply Current	Current Mode Shutdown Mode Sleep Mode		3 3 10	5 5 20	mA mA $\mu\text{A}$	
$V_{BAT(FLT)}$	Battery Regulated Float Voltage	$9\text{V} \leq V_{CC} \leq 22\text{V}$ (Note 2)	● 8.336 8.316	8.4	8.464 8.484	V V	
$V_{SNS(CHG)}$	Constant Current Sense Voltage	$6\text{V} \leq V_{BAT} \leq 8\text{V}$ (Note 3)	● 95 93	100 100	105 107	mV mV	
$V_{SNS(TRKL)}$	Trickle Current Sense Voltage	$V_{BAT} = 0\text{V}$ (Note 3)		5	10	15	mV
$V_{TRKL}$	Trickle Charge Threshold Voltage	$V_{BAT}$ Rising		4.7	5	5.3	V
$V_{UV}$	$V_{CC}$ Undervoltage Lockout Threshold Voltage	$V_{CC}$ Rising		7.5	8.5		V
$\Delta V_{UV}$	$V_{CC}$ Undervoltage Lockout Hysteresis Voltage			500			mV
$V_{MSD}$	Manual Shutdown Threshold Voltage	COMP Pin Falling		200	350	500	mV
$V_{ASD}$	Automatic Shutdown Threshold Voltage	$V_{CC} - V_{BAT}$			250		mV
$I_{COMP}$	COMP Pin Output Current	$V_{COMP} = 1.2\text{V}$		100			$\mu\text{A}$
$I_{CHRG}$	CHRG Pin Weak Pull-Down Current	$V_{CHRG} = 1\text{V}$		15	25	35	$\mu\text{A}$
$V_{CHRG}$	CHRG Pin Output Low Voltage	$I_{CHRG} = 1\text{mA}$			0.15	0.3	V
$R_{EOC}$	End-of-Charge Ratio	$V_{SNS(EOC)}/V_{SNS(CHG)}$		5	10	15	%
$t_{TIMER}$	Charge Time Accuracy				10		%
$I_{NTC}$	NTC Pin Output Current	$V_{NTC} = 0.85\text{V}$	● 75	85	95	$\mu\text{A}$	

## ELECTRICAL CHARACTERISTICS (LTC4002-8.4) The ● denotes the specifications which apply over the full operating temperature range, otherwise specifications are at $T_A = 25^\circ\text{C}$ . $V_{CC} = 12\text{V}$ unless otherwise noted.

SYMBOL	PARAMETER	CONDITIONS	MIN	TYP	MAX	UNITS
$V_{\text{NTC-HOT}}$	NTC Pin Threshold Voltage (Hot)	$V_{\text{NTC}}$ Falling Hysteresis	● 340	355 25	370	mV mV
$V_{\text{NTC-COLD}}$	NTC Pin Threshold Voltage (Cold)	$V_{\text{NTC}}$ Rising Hysteresis	● 2.428	2.465 170	2.502	V mV
$\Delta V_{\text{RECHRG}}$	Recharge Battery Voltage Offset from Full Charged Battery Voltage	$V_{\text{BAT(FULLCHARGED)}} - V_{\text{RECHRG}}$ , $V_{\text{BAT}}$ Falling	200	300	400	mV
$I_{\text{LEAK}}$	CHRG Pin Leakage Current	$V_{\text{CHRG}} = 8\text{V}$ , Charging Stops			1	$\mu\text{A}$

### Oscillator

$f_{\text{OSC}}$	Switching Frequency		450	500	550	kHz
DC	Maximum Duty Cycle				100	%

### Gate Drive

$t_r$	Rise Time	$C_{\text{GATE}} = 2000\text{pF}$ , 10% to 90%		20		ns
$t_f$	Fall Time	$C_{\text{GATE}} = 2000\text{pF}$ , 90% to 10%		50		ns
$\Delta V_{\text{GATE}}$	Output Clamp Voltage	$V_{CC} - V_{\text{GATE}}$	●		8	V
$\Delta V_{\text{GATEHI}}$	Output High Voltage	$\Delta V_{\text{GATEHI}} = V_{CC} - V_{\text{GATE}}$	●		0.3	V
$\Delta V_{\text{GATELO}}$	Output Low Voltage	$\Delta V_{\text{GATELO}} = V_{CC} - V_{\text{GATE}}$	●	4.5		V

**Note 1:** Absolute Maximum Rating are those values beyond which the life of a device may be impaired.

**Note 2:** The LTC4002 is tested with Test Circuit 1.

**Note 3:** The LTC4002 is tested with Test Circuit 2.

**Note 4:** The LTC4002 is guaranteed to meet performance specifications from  $0^\circ\text{C}$  to  $70^\circ\text{C}$ . Specifications over the  $-40^\circ\text{C}$  to  $85^\circ\text{C}$  operating temperature range are assured by design, characterization and correlation with statistical process controls.

## TYPICAL PERFORMANCE CHARACTERISTICS $T_A = 25^\circ\text{C}$ , $V_{CC} = 10\text{V}$ unless otherwise noted.

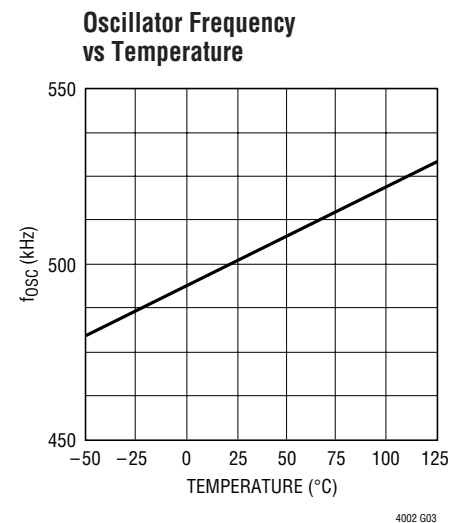
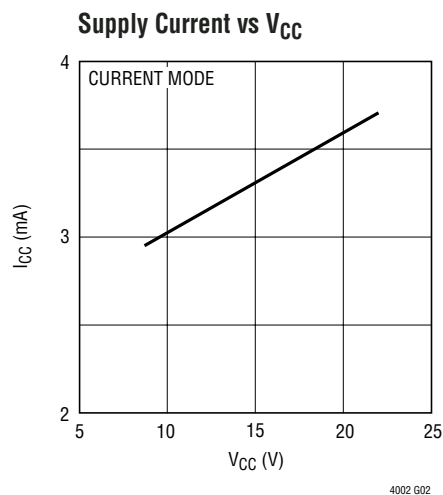
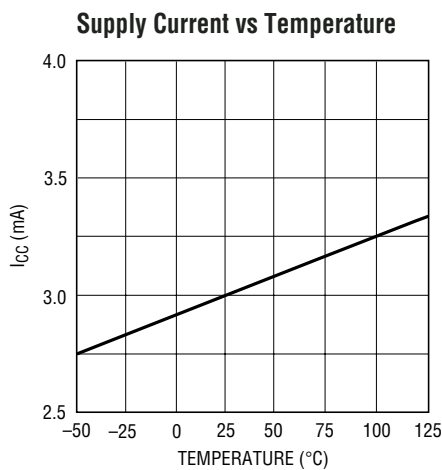

**TYPICAL PERFORMANCE CHARACTERISTICS**  $T_A = 25^\circ\text{C}$ ,  $V_{CC} = 10\text{V}$  unless otherwise noted.

**Oscillator Frequency vs  $V_{CC}$**

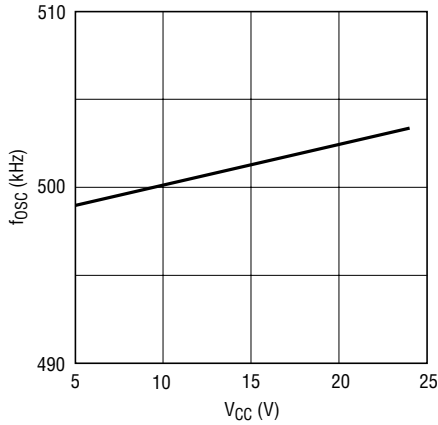

4002 G04

**Undervoltage Lockout Threshold vs Temperature**

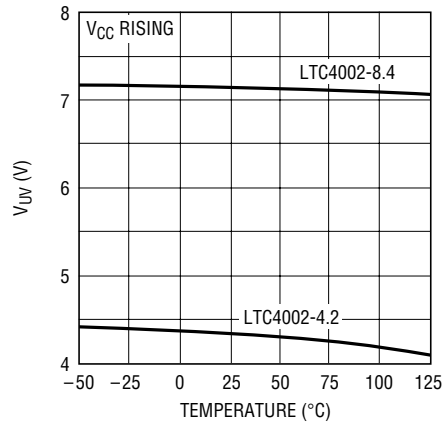

4002 G05

**CHRG Pin Output Low Voltage vs  $V_{CC}$**

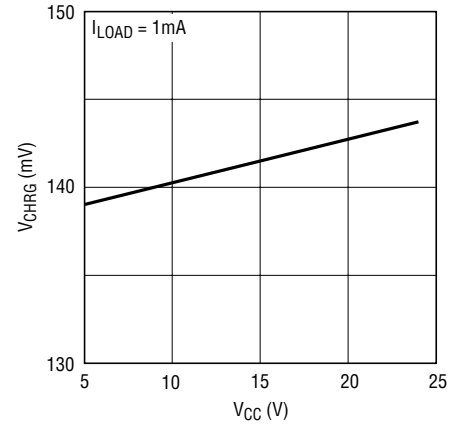

4002 G06

**CHRG Pin Output Low Voltage vs Temperature**

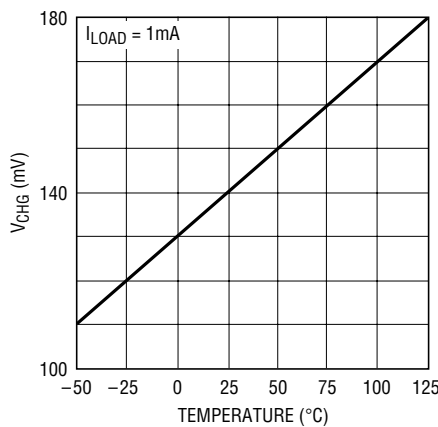

4002 G07

**CHRG Pin Weak Pull-Down Current vs Temperature**

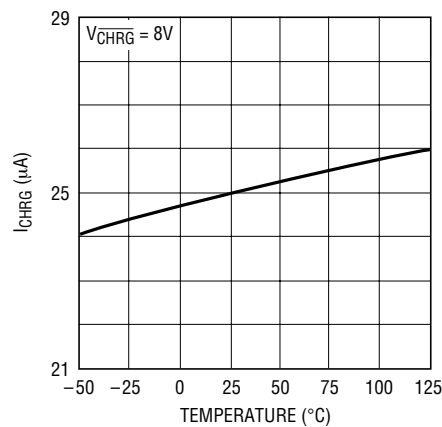

4002 G08

**CHRG Output Pin Weak Pull-Down Current vs  $V_{CC}$**

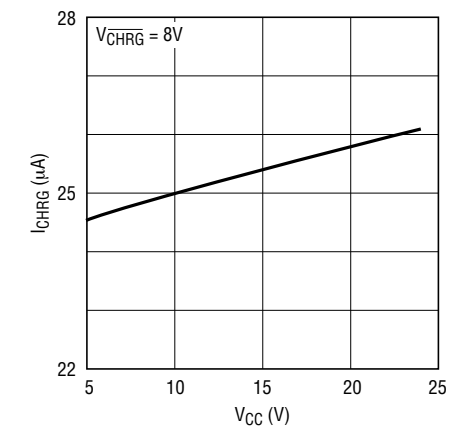

4002 G09

**Recharge Voltage Offset Per Cell from Full Charged Voltage vs Temperature**

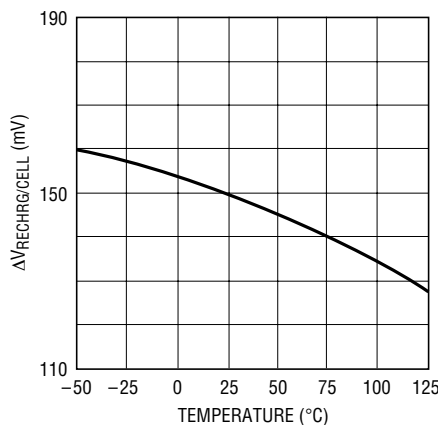

4002 G10

**Recharge Voltage Offset from Full Charged Voltage vs  $V_{CC}$**

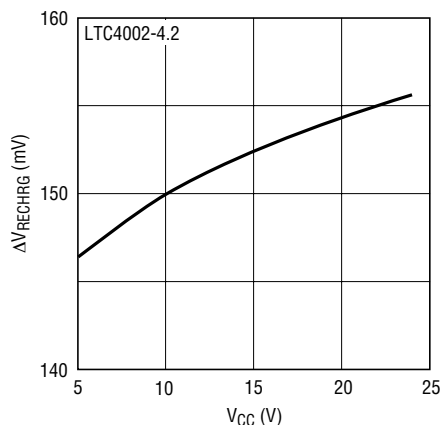

4002 G11

**Recharge Voltage Offset from Full Charged Voltage vs  $V_{CC}$**

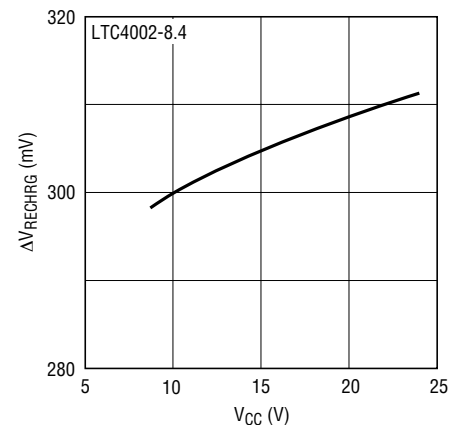

4002 G12

4002f

## TYPICAL PERFORMANCE CHARACTERISTICS $T_A = 25^\circ\text{C}$ , $V_{CC} = 10\text{V}$ unless otherwise noted.

**Current Mode Sense Voltage vs Temperature**

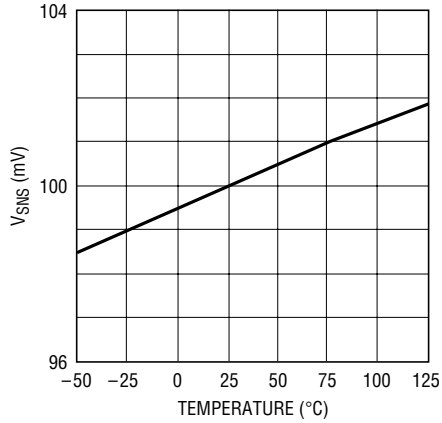

4002 G13

**Current Mode Sense Voltage vs V<sub>CC</sub>**

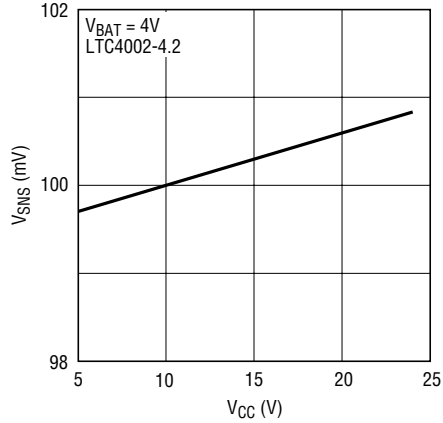

4002 G14

**Current Mode Sense Voltage vs V<sub>CC</sub>**

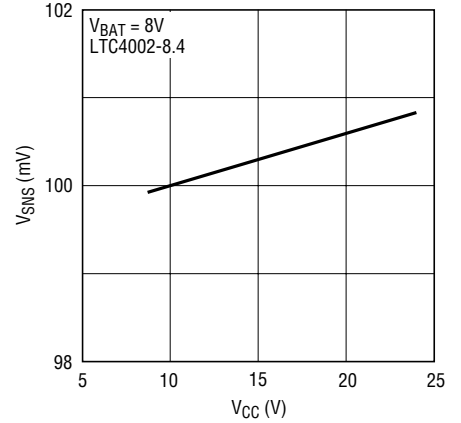

4002 G15

**COMP Pin Output Current vs V<sub>CC</sub>**

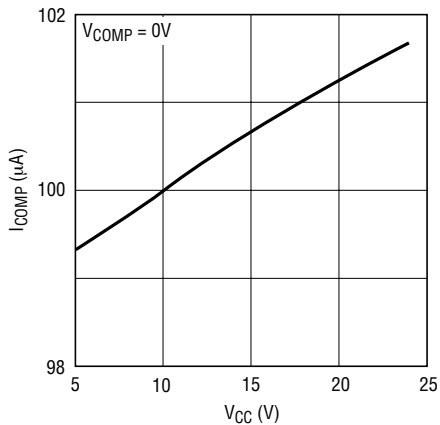

4002 G16

**COMP Pin Output Current vs Temperature**

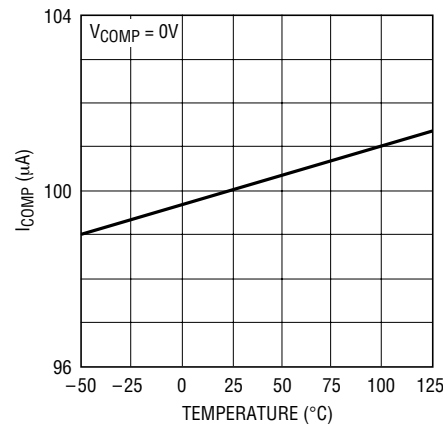

4002 G17

**NTC Pin Output Current vs V<sub>CC</sub>**

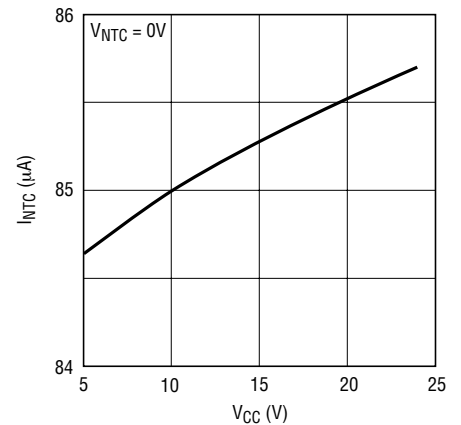

4002 G18

**Trickle Charge Voltage vs Temperature**

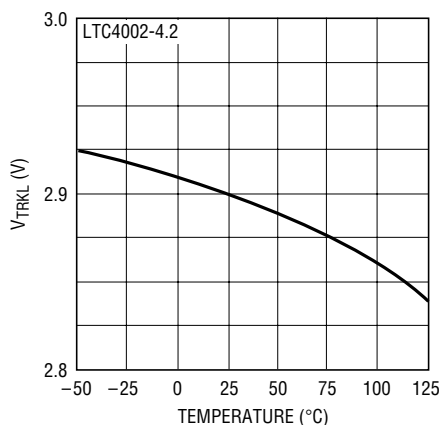

4002 G19

**Trickle Charge Voltage vs V<sub>CC</sub>**

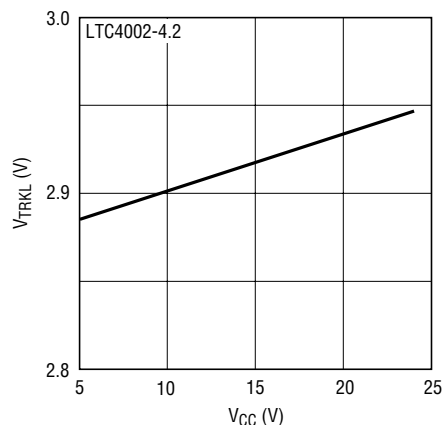

4002 G20

**Trickle Charge Voltage vs Temperature**

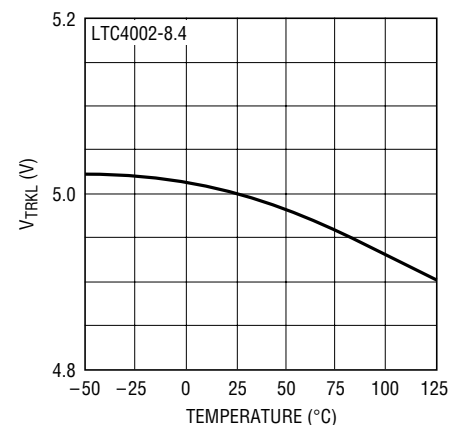

4002 G21

4002f

## TYPICAL PERFORMANCE CHARACTERISTICS $T_A = 25^\circ\text{C}$ , $V_{CC} = 10\text{V}$ unless otherwise noted.

**Trickle Charge Voltage vs  $V_{CC}$**

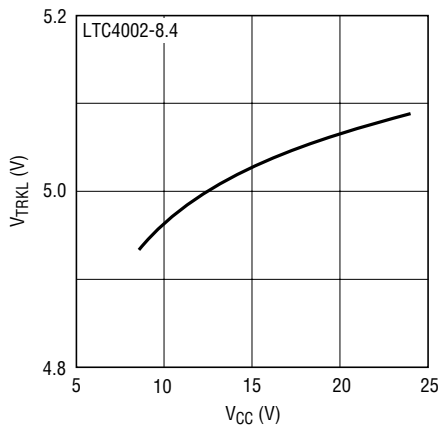

4002 G22

**Trickle Charge Sense Voltage vs Temperature**

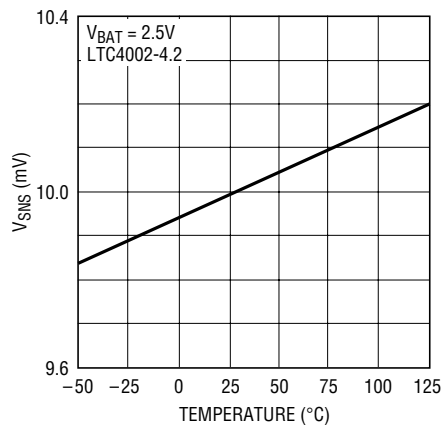

4002 G23

**Trickle Charge Sense Voltage vs  $V_{CC}$**

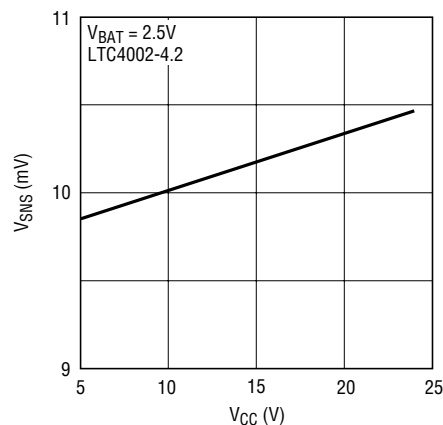

4002 G24

**Trickle Charge Sense Voltage vs Temperature**

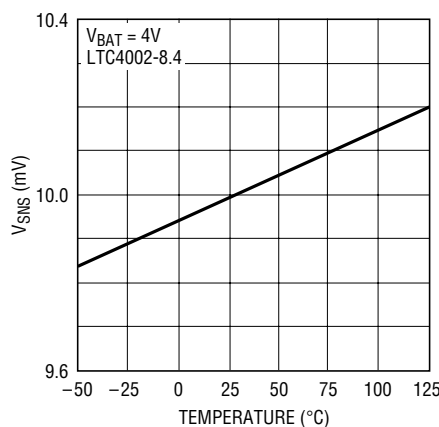

4002 G25

**Trickle Charge Sense Voltage vs  $V_{CC}$**

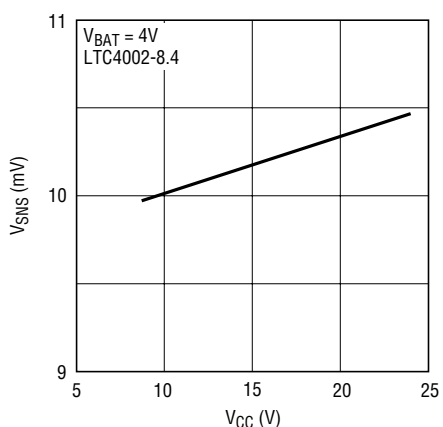

4002 G26

**NTC Pin Output Current vs Temperature**

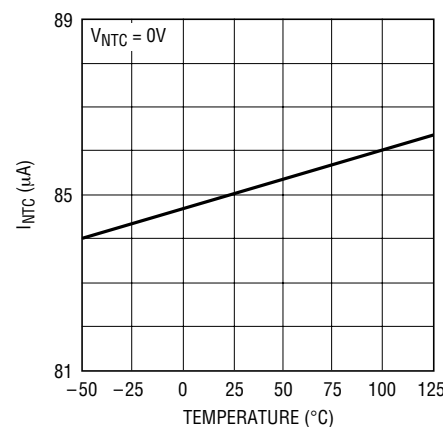

4002 G27

**End-of-Charge Ratio vs Temperature**

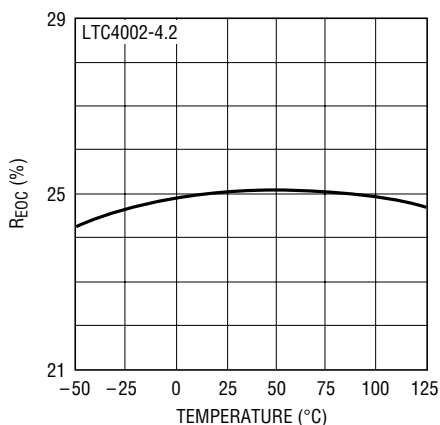

4002 G28

**End-of-Charge Ratio vs  $V_{CC}$**

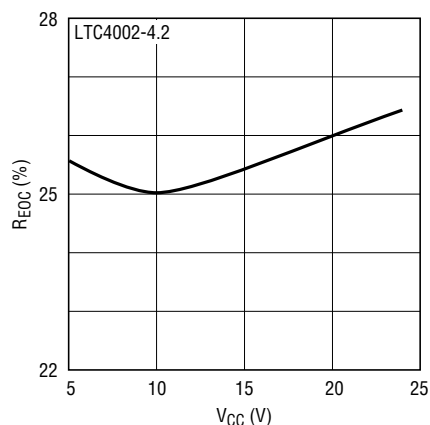

4002 G29

## TYPICAL PERFORMANCE CHARACTERISTICS $T_A = 25^\circ\text{C}$ , $V_{CC} = 10\text{V}$ unless otherwise noted.

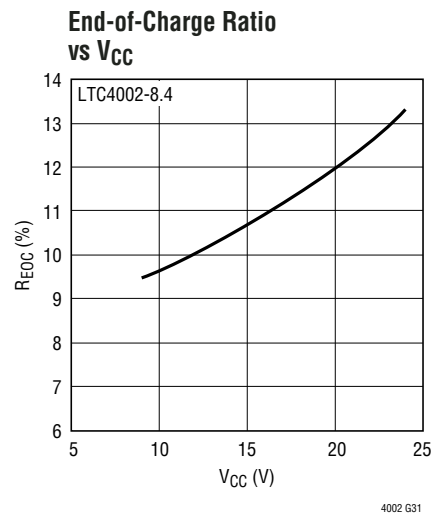
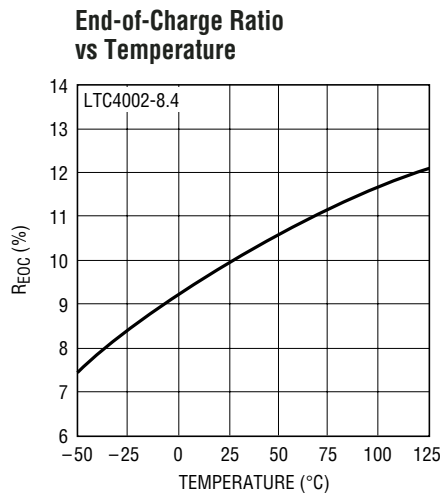

## PIN FUNCTIONS (DFN/SO-8)

**COMP (Pin 1/Pin 1):** Compensation, Soft-Start and Shutdown Control Pin. The COMP pin is the control signal of the inner loop of the current mode PWM. Charging begins when the COMP pin reaches 800mV. The recommended compensation components are a 0.47 $\mu\text{F}$  (or larger) capacitor and a 2.2k series resistor. A 100 $\mu\text{A}$  current into the compensation capacitor also sets the soft-start slew rate. Pulling the COMP pin below 360mV will shut down the charger.

**$V_{CC}$  (Pin 2/Pin 2):** Positive Supply Voltage Input.  $V_{CC}$  can range from  $V_{BAT(FLT)} + 0.5\text{V}$  to 22V. A 0.1 $\mu\text{F}$  or higher capacitor is required at the  $V_{CC}$  pin with the lead length kept to a minimum. A 10 $\mu\text{F}$  low ESR capacitor is also required at the source pins of the power P-channel MOSFET.

**GATE (Pin 3/Pin 3):** Gate Drive Output. Driver Output for the P-Channel MOSFET. The voltage at this pin is internally clamped to 8V below  $V_{CC}$ , allowing a low voltage MOSFET with gate-to-source breakdown voltage of 8V or less to be used.

**PGND, SGND, Exposed Pad, GND (Pins 4, 5, 11/Pin 4):** IC Ground. The exposed pad (DFN) must be soldered to PCB ground to provide both electrical contact and optimum thermal performance.

**CHRG (Pin 6/Pin 5):** Open-Drain Charge Status Output. When the battery is being charged, the  $\overline{\text{CHRG}}$  pin is pulled low by an internal N-channel MOSFET. When the charge

current drops below the End-of-Charge threshold for more than 120 $\mu\text{s}$ , the N-channel MOSFET turns off and a 25 $\mu\text{A}$  current source is connected from the  $\overline{\text{CHRG}}$  pin to GND. When the timer runs out or the input supply is removed, the 25 $\mu\text{A}$  current source is turned off and the  $\overline{\text{CHRG}}$  pin becomes high impedance.

**BAT (Pin 7/Pin 6):** Battery Sense Input. A bypass capacitor of 22 $\mu\text{F}$  is required to minimize ripple voltage. An internal resistor divider, which is disconnected in sleep mode, sets the final float voltage at this pin. If the battery connection is opened when charging, an overvoltage circuit will limit the charger output voltage to 10% above the programmed float voltage.

When  $V_{BAT}$  is within 250mV of  $V_{CC}$ , the LTC4002 is forced into sleep mode, dropping  $I_{CC}$  to 10 $\mu\text{A}$ .

**SENSE (Pin 8/Pin 7):** Current Amplifier Sense Input. A sense resistor,  $R_{SENSE}$ , must be connected between the SENSE and BAT pins. The maximum charge current is equal to  $100\text{mV}/R_{SENSE}$ .

**NTC (Pin 9/Pin 8):** NTC (Negative Temperature Coefficient) Thermistor Input. With an external 10k $\Omega$  NTC thermistor to ground, this pin senses the temperature of the battery pack and stops the charger when the temperature is out of range. When the voltage at this pin drops below 355mV at

## PIN FUNCTIONS (DFN/SO-8)

hot temperature or rises above 2.465V at cold temperature, charging is suspended and the internal timer stops. The CHRG pin output is not affected during this hold state. To

disable the temperature qualification function, ground the NTC pin.

**NC (Pin 10/NA):** No Connect.

## BLOCK DIAGRAM

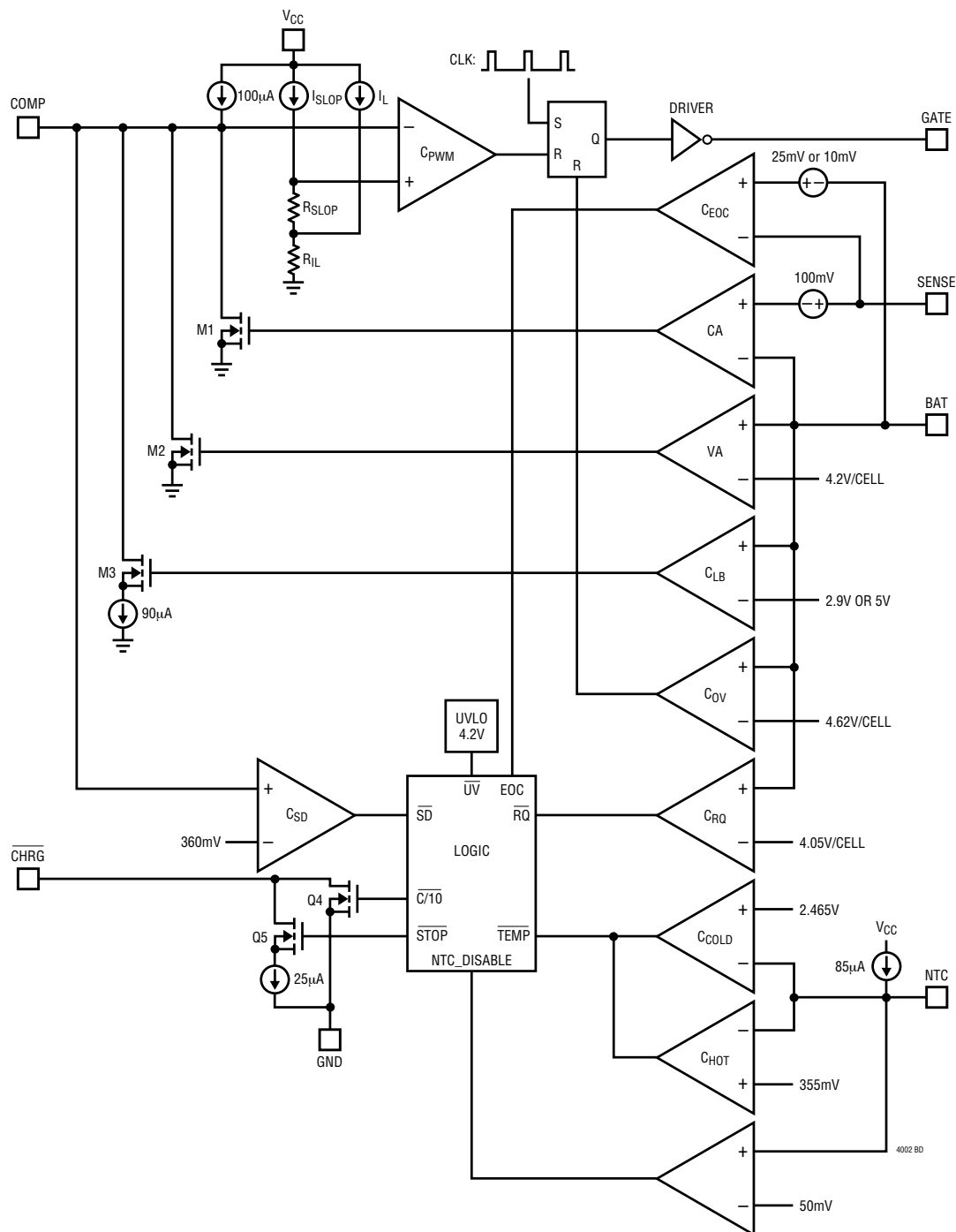

## TEST CIRCUITS

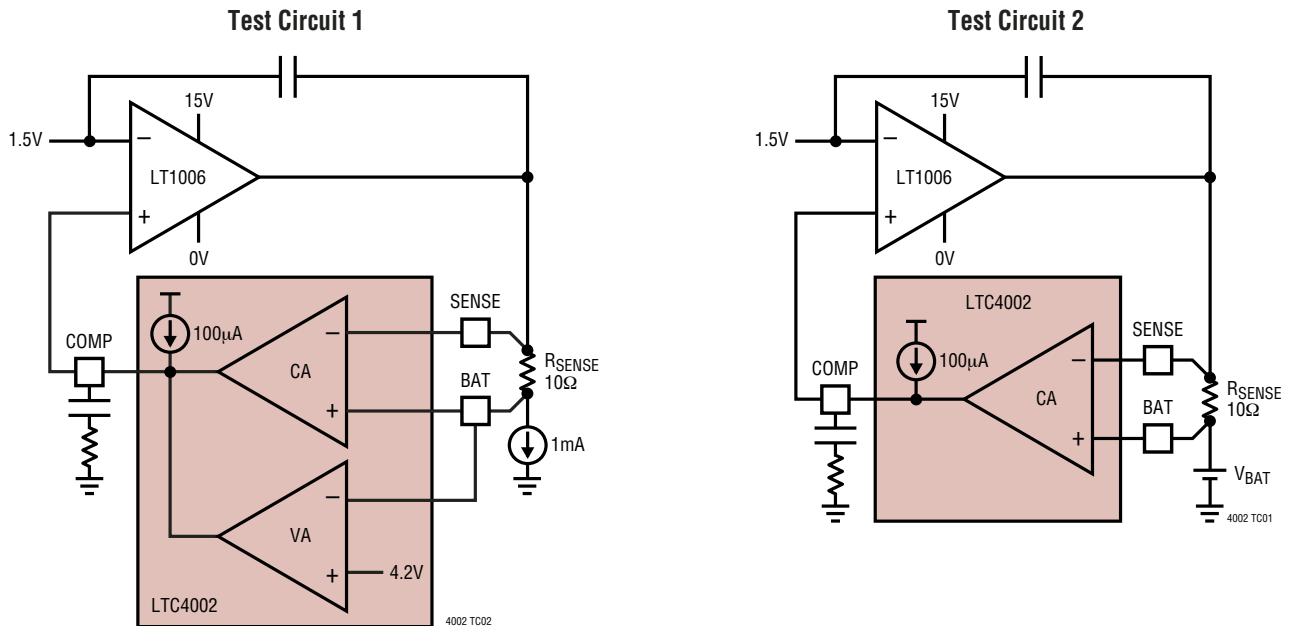

## OPERATION

The LTC4002 is a constant current, constant voltage Li-Ion battery charger controller that uses a current mode PWM step-down (buck) switching architecture. The charge current is set by an external sense resistor ( $R_{SENSE}$ ) across the SENSE and BAT pins. The final battery float voltage is internally set to 4.2V per cell. For batteries like lithium-ion that require accurate final float voltage, the internal 2.465V reference, voltage amplifier and the resistor divider provide regulation with  $\pm 1\%$  accuracy.

A charge cycle begins when the voltage at the  $V_{CC}$  pin rises above the UVLO level and is 250mV or more greater than the battery voltage. At the beginning of the charge cycle, if the battery voltage is less than the trickle charge threshold, 2.9V for the 4.2 version and 5V for the 8.4 version, the charger goes into trickle charge mode. The trickle charge current is internally set to 10% of the full-scale current. If the battery voltage stays low for 30 minutes, the battery is considered faulty and the charge cycle is terminated.

When the battery voltage exceeds the trickle charge threshold, the charger goes into the full-scale constant current

charge mode. In constant current mode, the charge current is set by the external sense resistor  $R_{SENSE}$  and an internal 100mV reference;  $I_{BAT} = 100\text{mV}/R_{SENSE}$ .

When the battery voltage approaches the programmed float voltage, the charge current will start to decrease. When the current drops to 25% (4.2 version) or 10% (8.4 version) of the full-scale charge current, an internal comparator turns off the internal pull-down N-channel MOSFET at the CHRG pin, and connects a weak current source to ground to indicate a near end-of-charge condition.

An internal 3 hour timer determines the total charge time. After a time out occurs, the charge cycle is terminated and the CHRG pin is forced high impedance. To restart the charge cycle, remove and reapply the input voltage or momentarily shut the charger down. Also, a new charge cycle will begin if the battery voltage drops below the recharge threshold voltage of 4.05V per cell.

When the input voltage is present, the charger can be shut down ( $I_{CC} = 3\text{mA}$ ) by pulling the COMP pin low. When the input voltage is not present, the charger goes into sleep

## OPERATION

mode, dropping  $I_{CC}$  to  $10\mu\text{A}$ . This will greatly reduce the current drain on the battery and increase the standby time.

A  $10\text{k}\Omega$  NTC (negative temperature coefficient) thermistor can be connected from the NTC pin to ground for battery

temperature qualification. The charge cycle is suspended when the temperature is outside of the  $0^\circ\text{C}$  to  $50^\circ\text{C}$  window (with DALE NTHS-1206N02).

## APPLICATIONS INFORMATION

### Undervoltage Lockout (UVLO)

An undervoltage lockout circuit monitors the input voltage and keeps the charger off until  $V_{CC}$  rises above the UVLO threshold ( $4.2\text{V}$  for the 4.2 version,  $7.5\text{V}$  for the 8.4 version) and at least  $250\text{mV}$  above the battery voltage. To prevent oscillation around the threshold voltage, the UVLO circuit has  $200\text{mV}$  per cell of built-in hysteresis. When specifying minimum input voltage requirements, the voltage drop across the input blocking diode must be added to the minimum  $V_{CC}$  supply voltage specification.

### Trickle Charge and Defective Battery Detection

At the beginning of a charge cycle, if the battery voltage is below the trickle charge threshold, the charger goes into trickle charge mode with the charge current reduced to 10% of the full-scale current. If the low-battery voltage persists for 30 minutes, the battery is considered defective, the charge cycle is terminated and the  $\overline{\text{CHRG}}$  pin is forced high impedance.

### Shutdown

The LTC4002 can be shut down by pulling the COMP pin to ground which pulls the GATE pin high turning off the external P-channel MOSFET. When the COMP pin is released, the internal timer is reset and a new charge cycle starts. In shutdown, the output of the  $\overline{\text{CHRG}}$  pin is high impedance and the quiescent current remains at  $3\text{mA}$ .

Removing the input power supply will put the charger into sleep mode. If the voltage at the  $V_{CC}$  pin drops below ( $V_{\text{BAT}} + 250\text{mV}$ ) or below the UVLO level, the LTC4002 goes into a low current ( $I_{CC} = 10\mu\text{A}$ ) sleep mode, reducing the battery drain current.

### $\overline{\text{CHRG}}$ Status Output Pin

When a charge cycle starts, the  $\overline{\text{CHRG}}$  pin is pulled to ground by an internal N-channel MOSFET which is capable of driving an LED. When the charge current drops below the End-of-Charge threshold for more than  $120\mu\text{s}$ , the N-channel MOSFET turns off and a weak  $25\mu\text{A}$  current source to ground is connected to the  $\overline{\text{CHRG}}$  pin. This weak  $25\mu\text{A}$  pull-down remains until the timer ends the charge cycle, or the charger is in manual shutdown or sleep mode.

After a time out occurs (charge cycle ends), the pin will become high impedance. By using two different value resistors, a microprocessor can detect three states from this pin (charging, end-of-charge and charging stopped) see Figure 1.

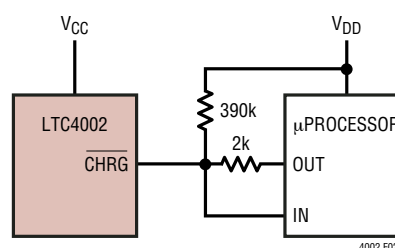

Figure 1. Microprocessor Interface

To detect the charge mode, force the digital output pin, OUT, high and measure the voltage at the CHRG pin. The N-channel MOSFET will pull the pin low even with a  $2\text{k}$  pull-up resistor. Once the charge current drops below the End-of-Charge threshold, the N-channel MOSFET is turned off and a  $25\mu\text{A}$  current source is connected to the  $\overline{\text{CHRG}}$  pin. The IN pin will then be pulled high by the  $2\text{k}$  resistor connected to OUT. Now force the OUT pin into a high

## APPLICATIONS INFORMATION

impedance state, the current source will pull the pin low through the  $390k$  resistor. When the internal timer has expired, the  $\overline{\text{CHRG}}$  pin changes to a high impedance state and the  $390k$  resistor will then pull the pin high to indicate charging has stopped.

### Gate Drive

The LTC4002 gate driver can provide high transient currents to drive the external pass transistor. The rise and fall times are typically 20ns and 50ns respectively when driving a 2000pF load, which is typical for a P-channel MOSFET with  $R_{\text{DS(ON)}}$  in the range of 50m $\Omega$ .

A voltage clamp is added to limit the gate drive to 8V below  $V_{\text{CC}}$ . For example, if  $V_{\text{CC}}$  is 10V then the GATE output will pull down to 2V max. This allows low voltage P-channel MOSFETs with superior  $R_{\text{DS(ON)}}$  to be used as the pass transistor thus increasing efficiency.

### Stability

Both the current loop and the voltage loop share a common, high impedance, compensation node ( $\overline{\text{COMP}}$  pin). A series capacitor and resistor on this pin compensates both loops. The resistor is included to provide a zero in the loop response and boost the phase margin.

The compensation capacitor also provides a soft-start function for the charger. Upon start-up, the  $\overline{\text{COMP}}$  pin voltage will quickly rise to 0.22V, due to the 2.2k series resistor, then ramp at a rate set by the internal 100 $\mu\text{A}$  pull-up current source and the external capacitor. Battery charge current starts ramping up when the  $\overline{\text{COMP}}$  pin voltage reaches 0.8V and full current is achieved with the

$\overline{\text{COMP}}$  pin at 1.3V. With a 0.47 $\mu\text{F}$  capacitor, time to reach full charge current is about 2.35ms. Capacitance can be increased up to 1 $\mu\text{F}$  if a longer start-up time is needed.

### Automatic Battery Recharge

After the 3 hour charge cycle is completed and both the battery and the input power supply (wall adapter) are still connected, a new charge cycle will begin if the battery voltage drops below 4.05V per cell due to self-discharge or external loading. This will keep the battery capacity at more than 80% at all times without manually restarting the charge cycle.

### Battery Temperature Detection

A negative temperature coefficient (NTC) thermistor located close to the battery pack can be used to monitor battery temperature and will not allow charging unless the battery temperature is within an acceptable range.

Connect a 10k $\Omega$  thermistor (DALE NTHS-1206N02) from the NTC pin to ground. If the temperature rises to 50 $^{\circ}\text{C}$ , the resistance of the NTC will be approximately 4.1k $\Omega$ . With the 85 $\mu\text{A}$  pull-up current source, the Hot temperature voltage threshold is 350mV. For Cold temperature, the voltage threshold is set at 2.465V which is equal to 0 $^{\circ}\text{C}$  ( $R_{\text{NTC}} \approx 28.4k\Omega$ ) with 85 $\mu\text{A}$  of pull-up current. If the temperature is outside the window, the GATE pin will be pulled up to  $V_{\text{CC}}$  and the timer frozen while the output status at the  $\overline{\text{CHRG}}$  pin remains the same. The charge cycle begins or resumes once the temperature is within the acceptable range. Short the NTC pin to ground to disable the temperature qualification feature.

## APPLICATIONS INFORMATION

### Input and Output Capacitors

Since the input capacitor is assumed to absorb all input switching ripple current in the converter, it must have an adequate ripple current rating. Worst-case RMS ripple current is approximately one-half of output charge current. Actual capacitance value is not critical. Solid tantalum capacitors have a high ripple current rating in a relatively small surface mount package, but caution must be used when tantalum capacitors are used for input bypass. High input surge currents can be created when the adapter is hot-plugged to the charger and solid tantalum capacitors have a known failure mechanism when subjected to very high turn-on surge currents. Selecting the highest possible voltage rating on the capacitor will minimize problems. Consult with the manufacturer before use.

The selection of output capacitor  $C_{OUT}$  is primarily determined by the ESR required to minimize ripple voltage and load step transients. The output ripple  $\Delta V_{OUT}$  is approximately bounded by:

$$\Delta V_{OUT} \leq \Delta I_L \left( ESR + \frac{1}{8f_{OSC}C_{OUT}} \right)$$

Since  $\Delta I_L$  increases with input voltage, the output ripple is highest at maximum input voltage. Typically, once the ESR requirement is satisfied, the capacitance is adequate for filtering and has the necessary RMS current rating.

Switching ripple current splits between the battery and the output capacitor depending on the ESR of the output capacitor and the battery impedance. EMI considerations usually make it desirable to minimize ripple current in the battery leads. Ferrite beads or an inductor may be added to increase battery impedance at the 500kHz switching frequency. If the ESR of the output capacitor is  $0.2\Omega$  and the battery impedance is raised to  $4\Omega$  with a bead or inductor, only 5% of the current ripple will flow in the battery.

### Design Example

As a design example, take a charger with the following specifications:  $V_{IN} = 5V$  to  $22V$ ,  $V_{BAT} = 4V$  nominal,  $I_{BAT} = 1.5A$ ,  $f_{OSC} = 500kHz$ , see Figure 2.

First, calculate the SENSE resistor :

$$R_{SENSE} = 100mV/1.5A = 68m\Omega$$

Choose the inductor for about 65% ripple current at the maximum  $V_{IN}$ :

$$L = \frac{4V}{(500kHz)(0.65)(1.5A)} \left( 1 - \frac{4V}{22V} \right) = 6.713\mu H$$

Selecting a standard value of  $6.8\mu H$  results in a maximum ripple current of :

$$\Delta I_L = \frac{4V}{(500kHz)(6.8\mu H)} \left( 1 - \frac{4V}{22V} \right) = 962.6mA$$

## APPLICATIONS INFORMATION

Next, choose the P-channel MOSFET. The Si6435ADQ in a TSSOP-8 package with  $R_{DS(ON)} = 42m\Omega$  (nom),  $55m\Omega$  (max) offers a small solution. The maximum power dissipation with  $V_{IN} = 5V$  and  $V_{BAT} = 4V$  at  $50^\circ C$  ambient temperature is:

$$P_D = \frac{(1.5A)^2(55m\Omega)(4V)}{5V} = 0.099W$$

$$T_J = 50^\circ C + (0.099W)(65^\circ C/W) = 56.5^\circ C$$

$C_{IN}$  is chosen for an RMS current rating of about 0.8A at  $85^\circ C$ . The output capacitor is chosen for an ESR similar to the battery impedance of about  $100m\Omega$ . The ripple voltage on the BAT pin is:

$$V_{OUT(RIPPLE)} = \frac{\Delta I_L(MAX)(ESR)}{2} = \frac{(0.96A)(0.1\Omega)}{2} = 48mV$$

C1: Taiyo Yuden TMK325BJ106MM

C2: Taiyo Yuden JMK325BJ226MM

L1: TOKO B952AS-6R8N

The Schottky diode D2 shown in Figure 2 conducts current when the pass transistor is off. In a low duty cycle case, the current rating should be the same or higher than the charge current. Also it should withstand reverse voltage as high as  $V_{IN}$ .

### Board Layout Suggestions

When laying out the printed circuit board, the following considerations should be taken to ensure proper operation of the LTC4002.

GATE pin rise and fall times are 20ns and 50ns respectively (with  $C_{GATE} = 2000pF$ ). To minimize radiation, the catch diode, pass transistor and the input bypass capacitor traces should be kept as short as possible. The positive side of the input capacitor should be close to the source of the P-channel MOSFET; it provides the AC current to the pass transistor. The connection between the catch diode and the pass transistor should also be kept as short as possible. The SENSE and BAT pins should be connected directly to the sense resistor (Kelvin sensing) for best charge current accuracy. Avoid routing the NTC PC board trace near the MOSFET switch to minimize coupling switching noise into the NTC pin.

The compensation capacitor connected at the COMP pin should return to the ground pin of the IC or as close to it as possible. This will prevent ground noise from disrupting the loop stability. The ground pin also works as a heat sink, therefore use a generous amount of copper around the ground pin. This is especially important for high  $V_{CC}$  and/or high gate capacitance applications.

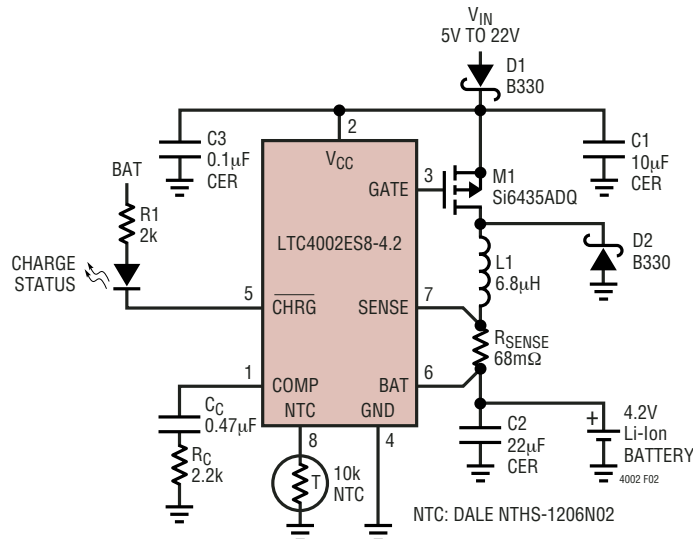
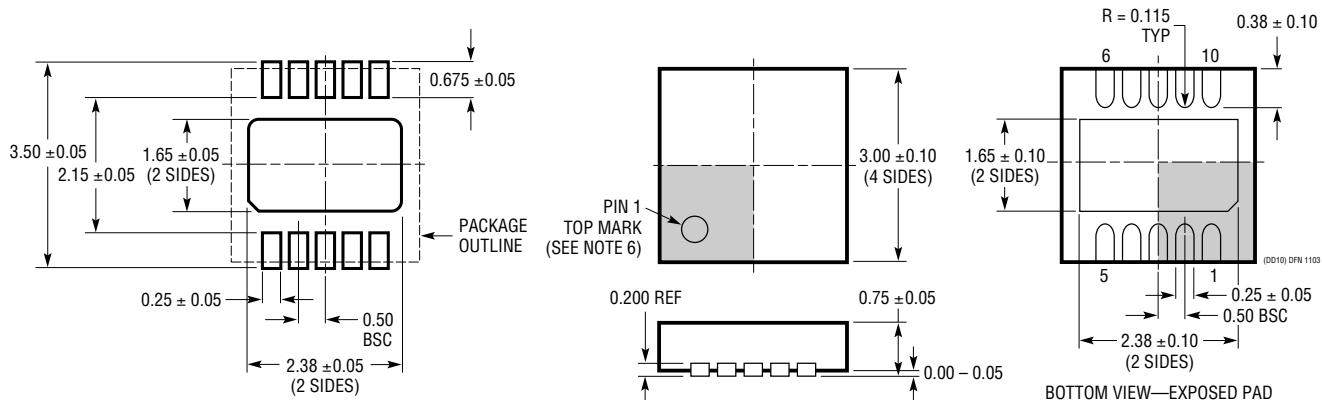

Figure 2. 1.5A Single Cell Li-Ion Battery Charger

# PACKAGE DESCRIPTION

## DD Package 10-Lead Plastic DFN (3mm × 3mm) (Reference LTC DWG # 05-08-1699)



RECOMMENDED SOLDER PAD PITCH AND DIMENSIONS

NOTE:

1. DRAWING TO BE MADE A JEDEC PACKAGE OUTLINE M0-229 VARIATION OF (WEED-2). CHECK THE LTC WEBSITE DATA SHEET FOR CURRENT STATUS OF VARIATION ASSIGNMENT
2. DRAWING NOT TO SCALE
3. ALL DIMENSIONS ARE IN MILLIMETERS
4. DIMENSIONS OF EXPOSED PAD ON BOTTOM OF PACKAGE DO NOT INCLUDE MOLD FLASH. MOLD FLASH, IF PRESENT, SHALL NOT EXCEED 0.15mm ON ANY SIDE
5. EXPOSED PAD SHALL BE SOLDER PLATED
6. SHADED AREA IS ONLY A REFERENCE FOR PIN 1 LOCATION ON THE TOP AND BOTTOM OF PACKAGE

## S8 Package 8-Lead Plastic Small Outline (Narrow .150 Inch) (Reference LTC DWG # 05-08-1610)

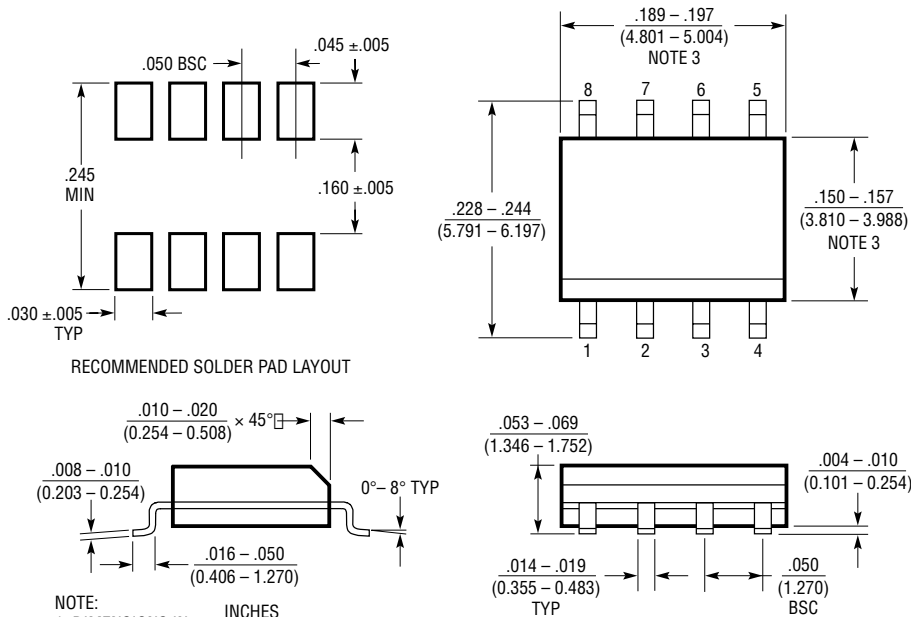

RECOMMENDED SOLDER PAD LAYOUT

- NOTE:
1. DIMENSIONS IN INCHES (MILLIMETERS)
  2. DRAWING NOT TO SCALE
  3. THESE DIMENSIONS DO NOT INCLUDE MOLD FLASH OR PROTRUSIONS. MOLD FLASH OR PROTRUSIONS SHALL NOT EXCEED .006" (0.15mm)

S08 0303

## TYPICAL APPLICATION

### 2-Cell 8.4V, 2A Li-Ion Battery Charger

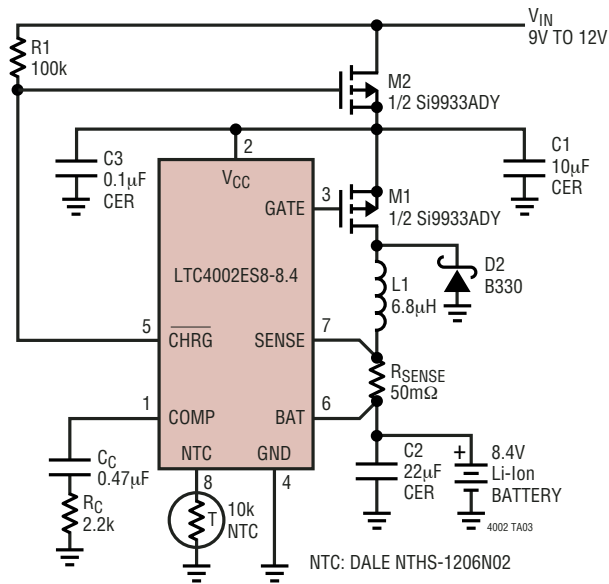

## RELATED PARTS

PART NUMBER	DESCRIPTION	COMMENTS
LTC1732-8.4	2-Cell Li-Ion Linear Battery Charger	8.8V ≤ VIN ≤ 12V; Programmable Charge Termination Timer Standalone Charger
LTC1733	Li-Ion Battery Charger with Thermal Regulation	Standalone Charger, Constant-Current/Constant-Voltage/Constant-Temperature, Integrated MOSFET, No External Sense Resistor or Blocking Diodes
LTC1734/LTC1734L	SOT-23 Li-Ion Battery Chargers	Need Only Two External Components, Monitors Charge Current, No Reverse Diode or Sense Resistor Required, 50mA to 700mA
LTC1980	Combination Battery Charger and DC/DC Converter	Wall Adapter May Be Above or Below Battery Voltage, Standalone, 1-, 2-Cell Li-Ion, Also for Charging NiMH and NiCd Batteries
LTC4006/LTC4007 LTC4008	4A Multiple Cell Li-Ion, NiCd, NiMH, Lead Acid Battery Chargers	6V ≤ VIN ≤ 28V, High Efficiency ≥ 90%, VOUT ≤ 28V, Digital Interface I/O, Small Inductor
LTC4052/LTC1730	Integrated Pulse Chargers for a 1-Cell Li-Ion Battery	0.35Ω Internal N-FET Requires No Blocking Diode, Current Limit for Safety
LTC4053	USB Compatible Li-Ion Linear Battery Charger	Charges from USB Input or AC/DC, 100mA/500mA Up to 1.25A, Thermal Regulation, Fully Integrated
LTC4054	Standalone Linear Li-Ion Battery Charger with Integrated Pass Transistor in ThinSOT™	Thermal Regulation Prevents Overheating, C/10 Termination, C/10 Indicator
LTC4056	Standalone SOT-23 Li-Ion Linear Battery Charger	Charge Termination Included, ICH ≤ 700mA, 8-Lead ThinSOT Package
LTC4412/LTC4413	Low Loss PowerPath™ Controllers in ThinSOT	Automatic Switching Between DC Sources, Simplified Load Sharing

PowerPath and ThinSOT are trademarks of Linear Technology Corporation.

## Looking for pricing, stock, or lifecycle information?

Click below to explore more details on WIN SOURCE:

 [View LTC4002EDD-8.4#PBF on WIN SOURCE](#)

 [Linear Technology](#) Information

## Optimize Your Supply Chain with WIN SOURCE Solutions

-  Global Sourcing Solution
-  Obsolete Management
-  Cost Control Management
-  Shortage Management
-  Alternative Solution
-  Excess Inventory Management