



**THE DATASHEET OF
LTC2751BIUHF-16#TRPBF**



LTC2751

ABSOLUTE MAXIMUM RATINGS (Notes 1, 2)

$I_{OUT1}, I_{OUT2}, R_{COM}$ to GND $\pm 0.3V$
 $R_{FB}, R_{OFS}, R_{IN}, REF, R_{VOS}$ to GND $\pm 15V$
 V_{DD} to GND $-0.3V$ to $7V$
 $S2, S1, S0, D15-D0, MSPAN, READ, D/S, WR,$
 UPD, CLR to GND $-0.3V$ to $V_{DD} + 0.3V$ (7V Max)

Operating Temperature Range
 LTC2751C $0^{\circ}C$ to $70^{\circ}C$
 LTC2751I $-40^{\circ}C$ to $85^{\circ}C$
 Maximum Junction Temperature $125^{\circ}C$
 Storage Temperature Range $-65^{\circ}C$ to $150^{\circ}C$

PIN CONFIGURATION

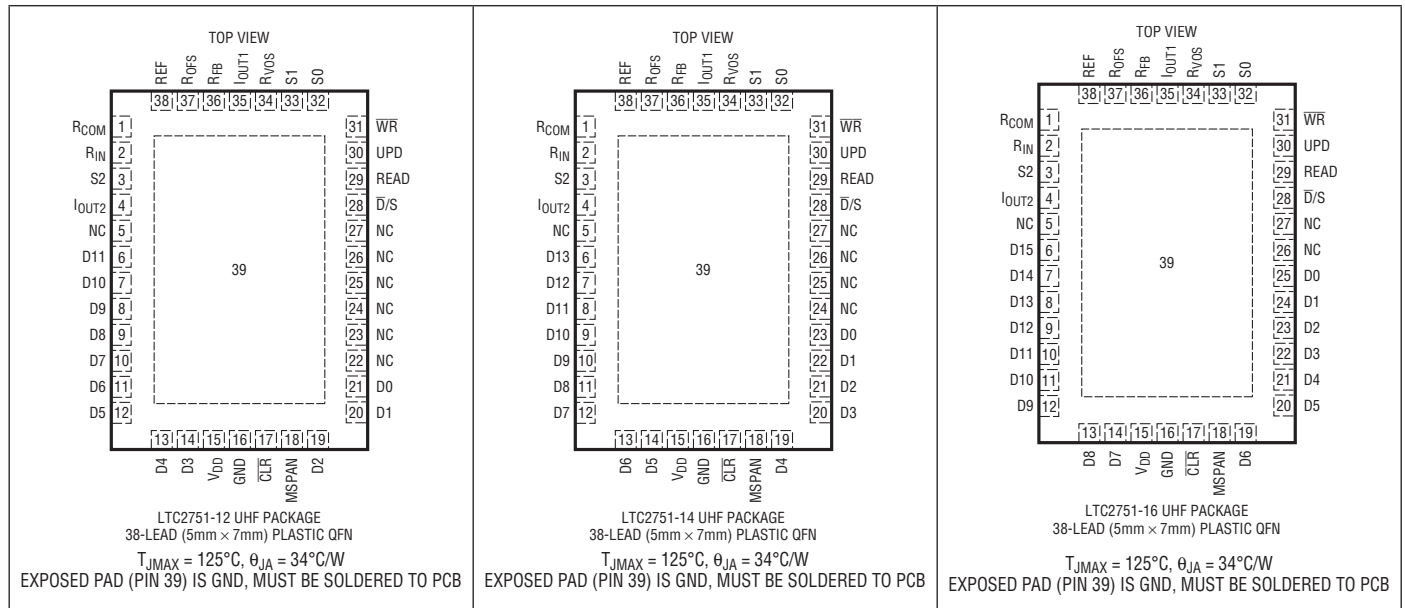

ORDER INFORMATION

LEAD FREE FINISH	TAPE AND REEL	PART MARKING*	PACKAGE DESCRIPTION	TEMPERATURE RANGE
LTC2751CUHF-12#PBF	LTC2751CUHF-12#TRPBF	275112	38-Lead (5mm × 7mm) Plastic QFN	$0^{\circ}C$ to $70^{\circ}C$
LTC2751IUHF-12#PBF	LTC2751IUHF-12#TRPBF	275112	38-Lead (5mm × 7mm) Plastic QFN	$-40^{\circ}C$ to $85^{\circ}C$
LTC2751CUHF-14#PBF	LTC2751CUHF-14#TRPBF	275114	38-Lead (5mm × 7mm) Plastic QFN	$0^{\circ}C$ to $70^{\circ}C$
LTC2751IUHF-14#PBF	LTC2751IUHF-14#TRPBF	275114	38-Lead (5mm × 7mm) Plastic QFN	$-40^{\circ}C$ to $85^{\circ}C$
LTC2751BCUHF-16#PBF	LTC2751BCUHF-16#TRPBF	275116	38-Lead (5mm × 7mm) Plastic QFN	$0^{\circ}C$ to $70^{\circ}C$
LTC2751BIUHF-16#PBF	LTC2751BIUHF-16#TRPBF	275116	38-Lead (5mm × 7mm) Plastic QFN	$-40^{\circ}C$ to $85^{\circ}C$
LTC2751ACUHF-16#PBF	LTC2751ACUHF-16#TRPBF	275116	38-Lead (5mm × 7mm) Plastic QFN	$0^{\circ}C$ to $70^{\circ}C$
LTC2751AIUHF-16#PBF	LTC2751AIUHF-16#TRPBF	275116	38-Lead (5mm × 7mm) Plastic QFN	$-40^{\circ}C$ to $85^{\circ}C$

Consult LTC Marketing for parts specified with wider operating temperature ranges. *The temperature grade is identified by a label on the shipping container. Consult LTC Marketing for information on non-standard lead based finish parts.

For more information on lead free part marking, go to: <http://www.linear.com/leadfree/>

For more information on tape and reel specifications, go to: <http://www.linear.com/tapeandreel/>

ELECTRICAL CHARACTERISTICS

$V_{DD} = 5V$, $V_{REF} = 5V$ unless otherwise specified. The ● denotes the specifications which apply over the full operating temperature range, otherwise specifications are at $T_A = 25^\circ C$.

SYMBOL	PARAMETER	CONDITIONS	LTC2751-12			LTC2751-14			LTC2751B-16			LTC2751A-16			UNITS
			MIN	TYP	MAX	MIN	TYP	MAX	MIN	TYP	MAX	MIN	TYP	MAX	
Static Performance															
	Resolution		●	12		14		16		16		16		Bits	
	Monotonicity		●	12		14		16		16		16		Bits	
DNL	Differential Nonlinearity		●		±1		±1		±1		±0.2	±1		LSB	
INL	Integral Nonlinearity		●		±1		±1		±2		±0.4	±1		LSB	
GE	Gain Error	All Output Ranges	●	±0.5	±2	±1.5	±5		±20		±4	±14		LSB	
GE _{TC}	Gain Error Temperature Coefficient	ΔGain/ΔTemp		±0.6		±0.6		±0.6		±0.6		±0.6		ppm/°C	
BZE	Bipolar Zero Error	All Bipolar Ranges	●	±0.2	±1	±0.6	±3		±12		±2	±8		LSB	
BZS _{TC}	Bipolar Zero Temperature Coefficient			±0.5		±0.5		±0.5		±0.5		±0.5		ppm/°C	
PSR	Power Supply Rejection	$V_{DD} = 5V, \pm 10\%$ $V_{DD} = 3V, \pm 10\%$	●		±0.025		±0.1		±0.4		±0.03	±0.2		LSB/V	
			●		±0.06		±0.25		±1		±0.1	±0.5			
I _{LKG}	I _{OUT1} Leakage Current	$T_A = 25^\circ C$ T_{MIN} to T_{MAX}	●	±0.05	±2	±0.05	±2	±0.05	±2	±0.05	±2	±0.05	±2	nA	
			●		±5		±5		±5		±5	±5			
C _{IOUT1}	Output Capacitance	Full-Scale Zero Scale		75 45		75 45		75 45		75 45		75 45		pF pF	

$V_{DD} = 5V$, $V_{REF} = 5V$ unless otherwise specified. The ● denotes specifications that apply over the full operating temperature range, otherwise specifications are at $T_A = 25^\circ C$.

SYMBOL	PARAMETER	CONDITIONS	MIN	TYP	MAX	UNITS
Resistances (Note 3)						
R1/R2	Reference Inverting Resistors	(Note 4)	●	16	20	kΩ
R _{REF}	DAC Input Resistance		●	8	10	kΩ
R _{FB}	Feedback Resistor	(Note 3)	●	8	10	kΩ
R _{OFS}	Bipolar Offset Resistor	(Note 3)	●	16	20	kΩ
R _{VOS}	Offset Adjust Resistor		●	800	1000	kΩ
Dynamic Performance						
	Output Settling Time	0V to 10V Range, 10V Step. To ±0.0015% FS (Note 5)		2		μs
	Glitch Impulse	(Note 6)		1		nV•s
	Digital-to-Analog Glitch Impulse	(Note 7)		1		nV•s
	Multiplying Feedthrough Error	0V to 10V Range, $V_{REF} = \pm 10V$, 10kHz Sine Wave		0.5		mV
THD	Total Harmonic Distortion	(Note 8) Multiplying		-110		dB
	Output Noise Voltage Density	(Note 9) at I _{OUT1}		13		nV/√Hz
Power Supply						
V _{DD}	Supply Voltage		●	2.7	5.5	V
I _{DD}	Supply Current, V _{DD}	Digital Inputs = 0V or V _{DD}	●	0.5	1	μA

ELECTRICAL CHARACTERISTICS

$V_{DD} = 5V$, $V_{REF} = 5V$ unless otherwise specified. The ● denotes the specifications which apply over the full operating temperature range, otherwise specifications are at $T_A = 25^\circ C$.

SYMBOL	PARAMETER	CONDITIONS	MIN	TYP	MAX	UNITS
Digital Inputs						
V_{IH}	Digital Input High Voltage	$3.3V \leq V_{DD} \leq 5.5V$ $2.7V \leq V_{DD} < 3.3V$	● ●	2.4 2		V V
V_{IL}	Digital Input Low Voltage	$4.5V < V_{DD} \leq 5.5V$ $2.7V \leq V_{DD} \leq 4.5V$	● ●		0.8 0.6	V V
I_{IN}	Digital Input Current	$V_{IN} = GND$ to V_{DD}	●		± 1	μA
C_{IN}	Digital Input Capacitance	$V_{IN} = 0V$ (Note 10)	●		6	pF
Digital Outputs						
V_{OH}	$I_{OH} = 200\mu A$		●	$V_{DD} - 0.4$		V
V_{OL}	$I_{OL} = 200\mu A$		●		0.4	V

TIMING CHARACTERISTICS

$V_{DD} = 5V$, $V_{REF} = 5V$ unless otherwise specified. The ● denotes specifications that apply over the full operating temperature range, otherwise specifications are at $T_A = 25^\circ C$.

SYMBOL	PARAMETER	CONDITIONS	MIN	TYP	MAX	UNITS
$V_{DD} = 4.5V$ to $5.5V$						
Write and Update Timing						
t_1	I/O Valid to \overline{WR} Rising Edge Set-Up		●	9		ns
t_2	I/O Valid to \overline{WR} Rising Edge Hold		●	9		ns
t_3	\overline{WR} Pulse Width		●	20		ns
t_4	UPD Pulse Width		●	20		ns
t_5	UPD Falling Edge to \overline{WR} Falling Edge	No Data Shoot-Through	●	0		ns
t_6	\overline{WR} Rising Edge to UPD Rising Edge	(Note 10)	●	0		ns
t_7	\overline{D}/S Valid to \overline{WR} Falling Edge Set-Up Time		●	9		ns
t_8	\overline{WR} Rising Edge to \overline{D}/S Valid Hold Time		●	9		ns
Readback Timing						
t_{13}	\overline{WR} Rising Edge to READ Rising Edge		●	9		ns
t_{14}	READ Falling Edge to \overline{WR} Falling Edge	(Note 10)	●	20		ns
t_{15}	READ Rising Edge to I/O Propagation Delay	$C_L = 10pF$	●		30	ns
t_{17}	UPD Valid to I/O Propagation Delay	$C_L = 10pF$	●		30	ns
t_{18}	\overline{D}/S Valid to READ Rising Edge	(Note 10)	●	9		ns
t_{19}	READ Rising Edge to UPD Rising Edge	No Update	●	9		ns
t_{20}	UPD Falling Edge to READ Falling Edge	No Update	●	9		ns
t_{22}	READ Falling Edge to UPD Rising Edge	(Note 10)	●	9		ns
t_{23}	I/O Bus Hi-Z to READ Rising Edge	(Note 10)	●	0		ns
t_{24}	READ Falling Edge to I/O Bus Active	(Note 10)	●	20		ns
CLR Timing						
t_{25}	CLR Pulse Width Low		●	20		ns

TIMING CHARACTERISTICS

$V_{DD} = 5V$, $V_{REF} = 5V$ unless otherwise specified. The ● denotes specifications that apply over the full operating temperature range, otherwise specifications are at $T_A = 25^\circ C$.

SYMBOL	PARAMETER	CONDITIONS	MIN	TYP	MAX	UNITS
$V_{DD} = 2.7V$ to $3.3V$						
Write and Update Timing						
t_1	I/O Valid to \overline{WR} Rising Edge Set-Up		●	18		ns
t_2	I/O Valid to \overline{WR} Rising Edge Hold		●	18		ns
t_3	\overline{WR} Pulse Width		●	30		ns
t_4	UPD Pulse Width		●	30		ns
t_5	UPD Falling Edge to \overline{WR} Falling Edge	No Data Shoot-Through	●	0		ns
t_6	\overline{WR} Rising Edge to UPD Rising Edge	(Note 10)	●	0		ns
t_7	\overline{D}/S Valid to \overline{WR} Falling Edge Set-Up Time		●	18		ns
t_8	\overline{WR} Rising Edge to \overline{D}/S Valid Hold Time		●	18		ns
Readback Timing						
t_{13}	\overline{WR} Rising Edge to Read Rising Edge		●	18		ns
t_{14}	Read Falling Edge to \overline{WR} Falling Edge	(Note 10)	●	40		ns
t_{15}	Read Rising Edge to I/O Propagation Delay	$C_L = 10pF$	●		40	ns
t_{17}	UPD Valid to I/O Propagation Delay	$C_L = 10pF$	●		40	ns
t_{18}	\overline{D}/S Valid to Read Rising Edge	(Note 10)	●	18		ns
t_{19}	Read Rising Edge to UPD Rising Edge	No Update	●	9		ns
t_{20}	UPD Falling Edge to Read Falling Edge	No Update	●	9		ns
t_{22}	READ Falling Edge to UPD Rising Edge	(Note 10)	●	18		ns
t_{23}	I/O Bus Hi-Z to Read Rising Edge	(Note 10)	●	0		ns
t_{24}	Read Falling Edge to I/O Bus Active	(Note 10)	●	40		ns
CLR Timing						
t_{25}	\overline{CLR} Pulse Width Low		●	30		ns

Note 1: Stresses beyond those listed under Absolute Maximum Ratings may cause permanent damage to the device. Exposure to any Absolute Maximum Rating condition for extended periods may affect device reliability and lifetime.

Note 2: Continuous operation above the specified maximum operating junction temperature may impair device reliability.

Note 3: Because of the proprietary SoftSpan switching architecture, the measured resistance looking into each of the specified pins is constant for all output ranges if the I_{OUT1} and I_{OUT2} pins are held at ground.

Note 4: R1 is measured from R_{IN} to R_{COM} ; R2 is measured from REF to R_{COM} .

Note 5: Using LT1469 with $C_{FEEDBACK} = 15pF$. A $\pm 0.0015\%$ settling time of $1.7\mu s$ can be achieved by optimizing the time constant on an individual

basis. See Application Note 74, "Component and Measurement Advances Ensure 16-Bit DAC Settling Time."

Note 6: Measured at the major carry transition, 0V to 5V range. Output amplifier = LT1469; $C_{FB} = 27pF$.

Note 7: Full-scale transition; REF = 0V.

Note 8: REF = $6V_{RMS}$ at 1kHz. 0V to 5V range. DAC code = FS. Output amplifier = LT1469.

Note 9: Calculation from $V_n = \sqrt{4kTRB}$, where $k = 1.38E-23 J/^\circ K$ (Boltzmann constant), R = resistance (Ω), T = temperature ($^\circ K$), and B = bandwidth (Hz).

Note 10: Guaranteed by design. Not production tested.

TYPICAL PERFORMANCE CHARACTERISTICS $T_A = 25^\circ\text{C}$, unless otherwise noted.

LTC2751-16

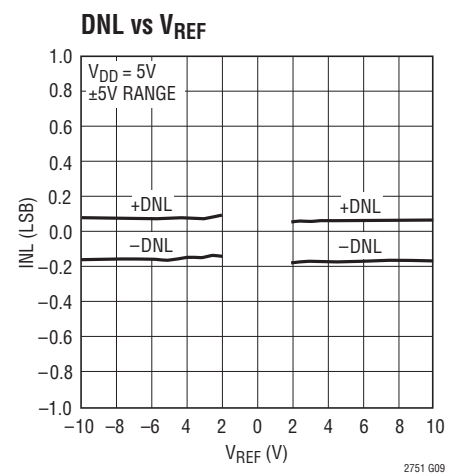
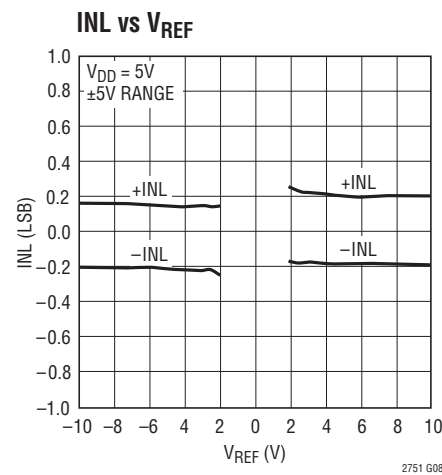
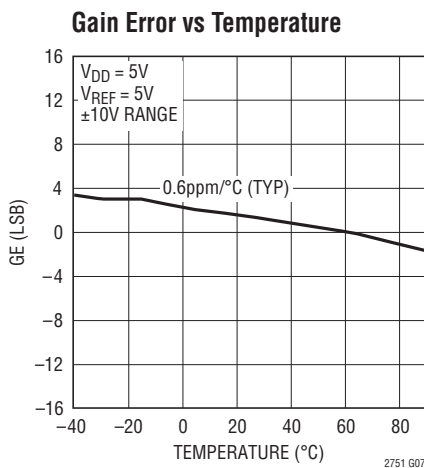
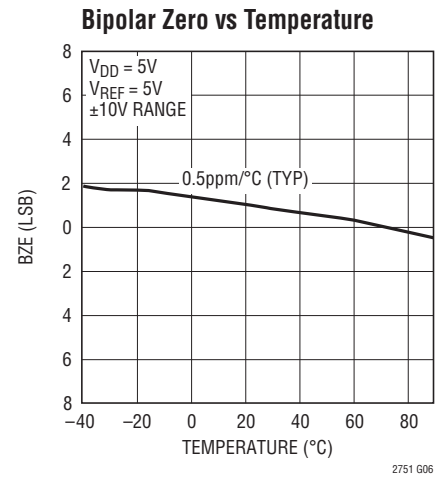
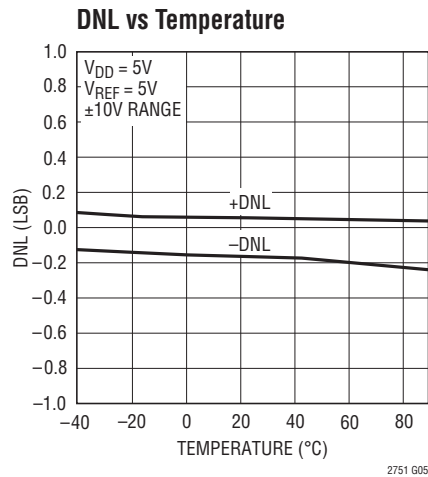
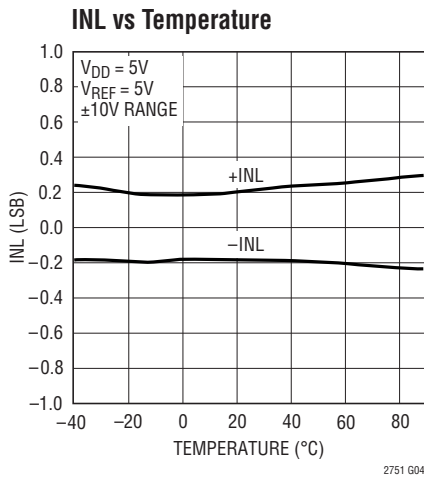
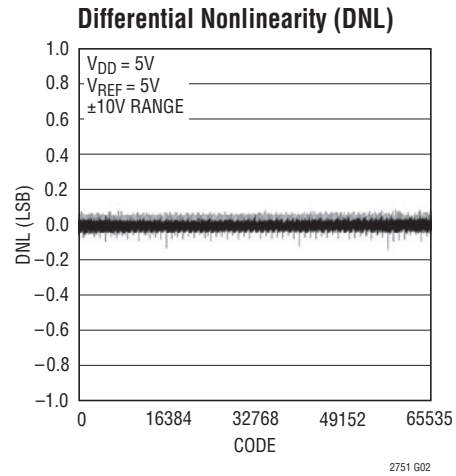
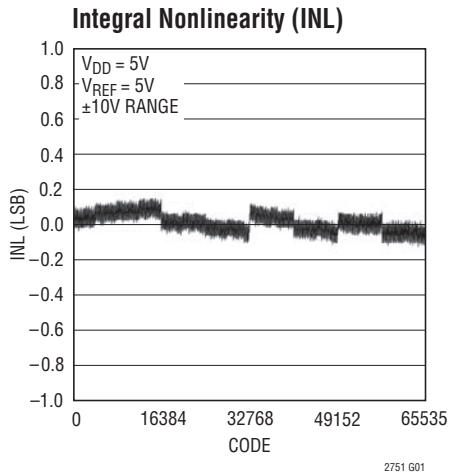

2751fa

TYPICAL PERFORMANCE CHARACTERISTICS $T_A = 25^\circ\text{C}$, unless otherwise noted.

LTC2751-16

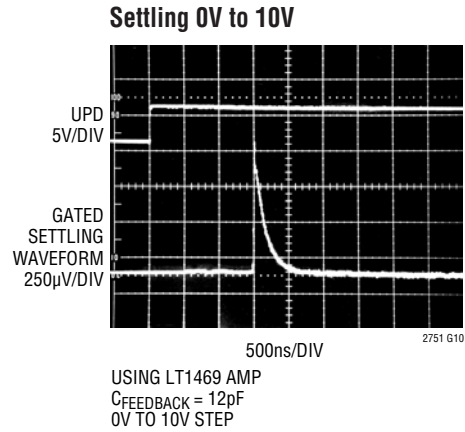
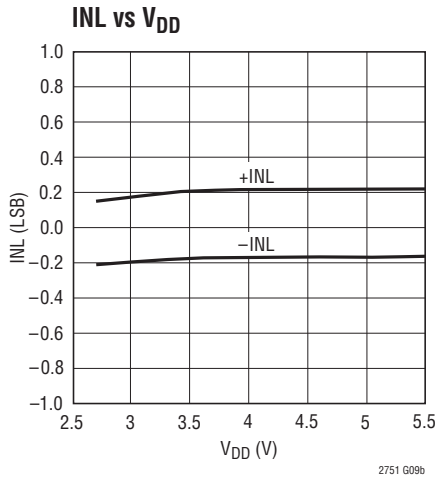

LTC2751-14

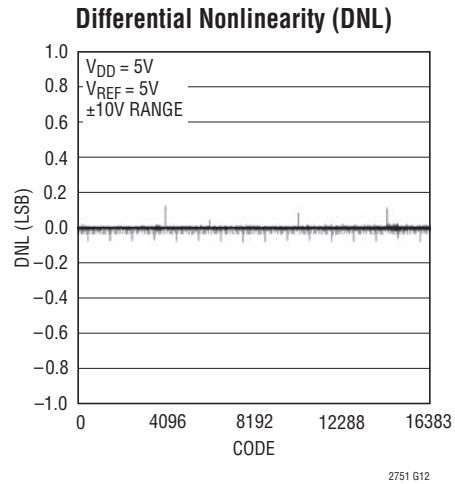
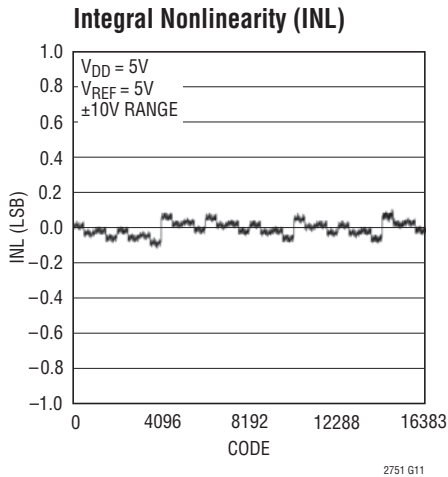

LTC2751-12

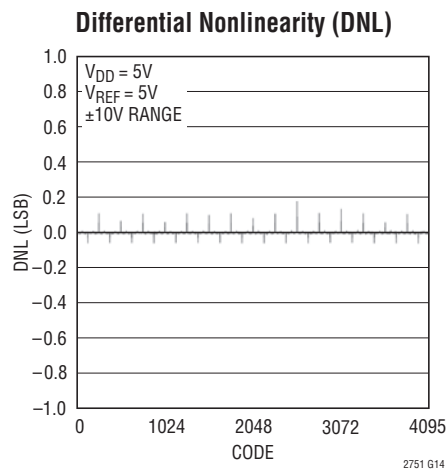
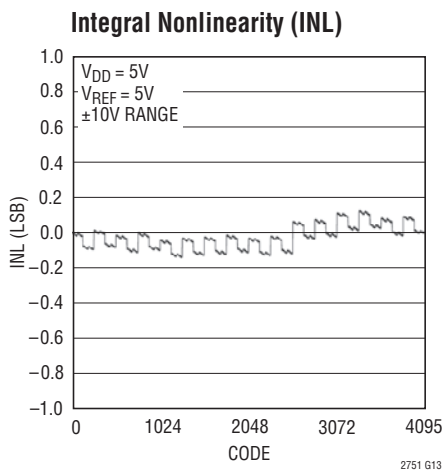

TYPICAL PERFORMANCE CHARACTERISTICS $T_A = 25^\circ\text{C}$, unless otherwise noted.

LTC2751-12, LTC2751-14, LTC2751-16

Midscale Glitch

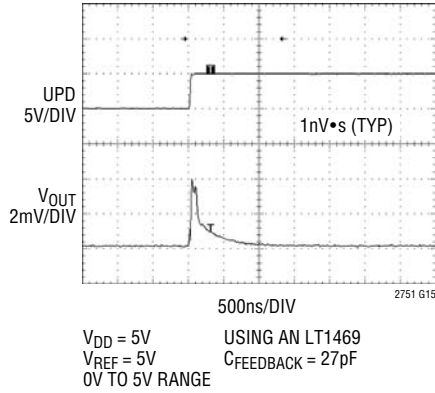

Supply Current vs Logic Input Voltage

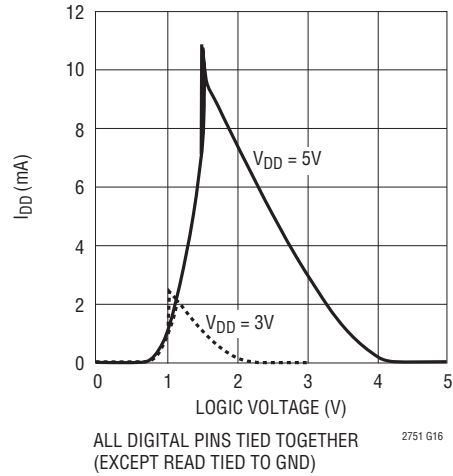

Logic Threshold vs Supply Voltage

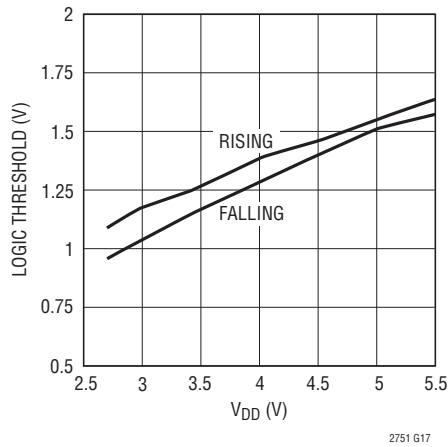

Supply Current vs Update Frequency

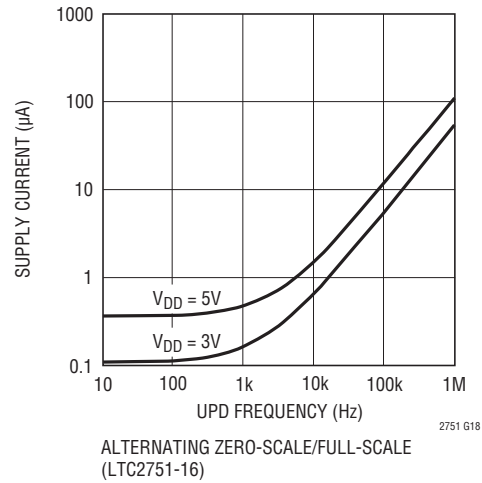

PIN FUNCTIONS

R_{COM} (Pin 1): Center Tap Point of R_{IN} and REF. Normally tied to the negative input of the external reference inverting amplifier.

R_{IN} (Pin 2): Input Resistor for External Reference Inverting Amplifier. Normally tied to the external reference voltage V_{REF} and to R_{OFS} (Pin 37). Typically 5V; accepts up to ±15V.

S2 (Pin 3): Span I/O Bit 2. Pins S0, S1 and S2 are used to program and to read back the output range of the DAC.

I_{OUT2} (Pin 4): DAC Current Output Complement. Tie I_{OUT2} to GND.

NC (Pin 5): No Connection. Must be tied to GND, provides necessary shielding for I_{OUT2}.

D3-D11 (Pins 6-14): LTC2751-12 Only. DAC Input/Output Data Bits. These I/O pins set and read back the DAC code. D11 is the MSB.

D5-D13 (Pins 6-14): LTC2751-14 Only. DAC Input/Output Data Bits. These I/O pins set and read back the DAC code. D13 is the MSB.

D7-D15 (Pins 6-14): LTC2751-16 Only. DAC Input/Output Data Bits. These I/O pins set and read back the DAC code. D15 is the MSB.

V_{DD} (Pin 15): Positive Supply Input $2.7V \leq V_{DD} \leq 5.5V$. Requires a 0.1μF bypass capacitor to GND.

GND (Pin 16): Ground. Tie to ground.

CL_R (Pin 17): Asynchronous Clear. When CL_R is taken to a logic low, the data registers are reset to the zero-volt code for the present output range (V_{OUT} = 0V).

MSPAN (Pin 18): Manual Span Control Pin. MSPAN is used to configure the LTC2751 for operation in a single, fixed output range. When configured for single-span operation, the output range is set via hardware pin strapping. The span input and DAC registers are transparent and do not respond to write or update commands.

To configure the part for single-span use, tie MSPAN directly to V_{DD}. If MSPAN is instead connected to GND (SoftSpan configuration), the output ranges are set and verified by using write, update and read operations. See Manual Span Configuration in the Operation section.

MSPAN must be connected either directly to GND (Soft-Span configuration) or V_{DD} (single-span configuration).

D0-D2 (Pins 19-21): LTC2751-12 Only. DAC Input/Output Data Bits. These I/O pins set and read back the DAC code. D0 is the LSB.

D0-D4 (Pins 19-23): LTC2751-14 Only. DAC Input/Output Data Bits. These I/O pins set and read back the DAC code. D0 is the LSB.

D0-D6 (Pins 19-25): LTC2751-16 Only. DAC Input/Output Data Bits. These I/O pins set and read back the DAC code. D0 is the LSB.

NC (Pins 22-27): LTC2751-12 Only. No Connection.

NC (Pins 24-27): LTC2751-14 Only. No Connection.

NC (Pins 26, 27): LTC2751-16 Only. No Connection.

D/S (Pin 28): Data/Span Select. This pin is used to select activation of the data or span I/O pins (D0 to D15 or S0 to S2, respectively), along with their respective dedicated registers, for write or read operations. Update operations ignore D/S, since all updates affect both data and span registers. For single-span operation, tie D/S to GND.

READ (Pin 29): Read Pin. When READ is asserted high, the data I/O pins (D0-D15) or span I/O pins (S0-S2) output the contents of the selected register (see Table 1). For single-span operation, readback of the span I/O pins is disabled.

UPD (Pin 30): Update and Buffer Select Pin. When READ is held low and UPD is asserted high, the contents of the input registers (both data and span) are copied into their respective DAC registers. The output of the DAC is updated, reflecting the new DAC register values.

When READ is held high, the update function is disabled and the UPD pin functions as a buffer selector—logic low to select the input register, high for the DAC register. See Readback in the Operation section.

WR (Pin 31): Active Low Write Pin. A Write operation copies the data present on the data or span I/O pins (D0-D15 or S0-S2, respectively) into the input register. When READ is high, the Write function is disabled.

S0 (Pin 32): Span I/O Bit 0. Pins S0, S1 and S2 are used to program and to read back the output range of the DAC.

PIN FUNCTIONS

S1 (Pin 33): Span I/O Bit 1. Pins S0, S1 and S2 are used to program and to read back the output range of the DAC.

R_{VOS} (Pin 34): DAC Offset Adjust. Nominal input range is $\pm 5V$. If not used, R_{VOS} should be shorted to I_{OUT2}.

I_{OUT1} (Pin 35): DAC current output; normally tied to the negative input of the I/V converter amplifier.

R_{FB} (Pin 36): DAC Feedback Resistor; normally tied to the output of the I/V converter amplifier. The DAC output current from I_{OUT1} flows through the feedback resistor to the R_{FB} pin.

R_{OFFS} (Pin 37): Bipolar Offset Network. This pin provides the translation of the output voltage range for bipolar spans. Accepts up to $\pm 15V$; normally tied to the positive reference voltage at R_{IN} (Pin 2).

REF (Pin 38): Feedback Resistor for the Reference Inverting Amplifier, and Reference Input for the DAC. Normally tied to the output of the reference inverting amplifier. Typically $-5V$. Accepts up to $\pm 15V$.

Exposed Pad (Pin 39): Ground. The Exposed Pad must be soldered to the PCB.

BLOCK DIAGRAM

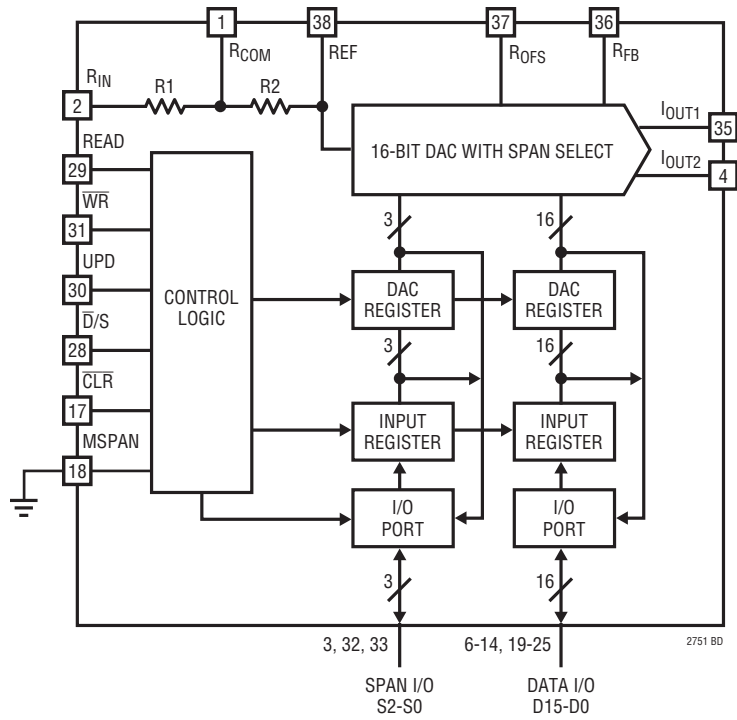

TIMING DIAGRAMS

Write, Update and Clear Timing

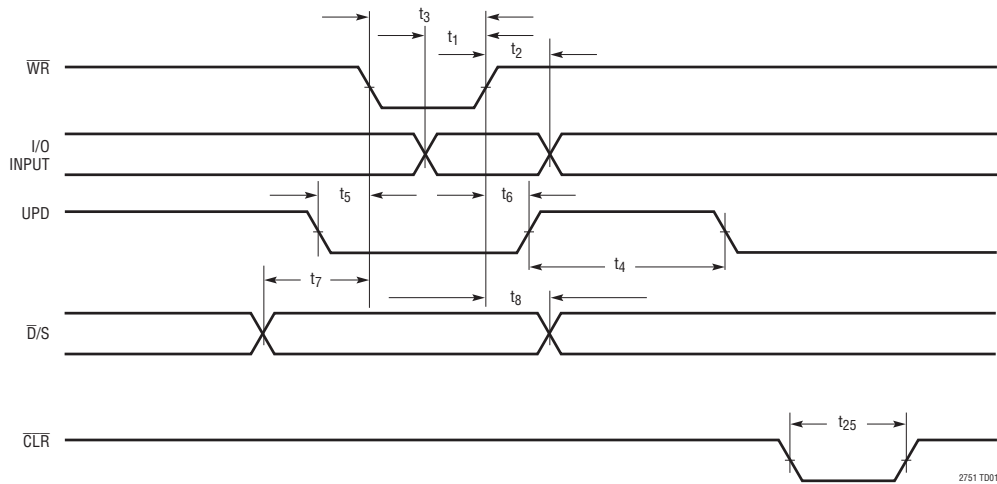

Readback Timing

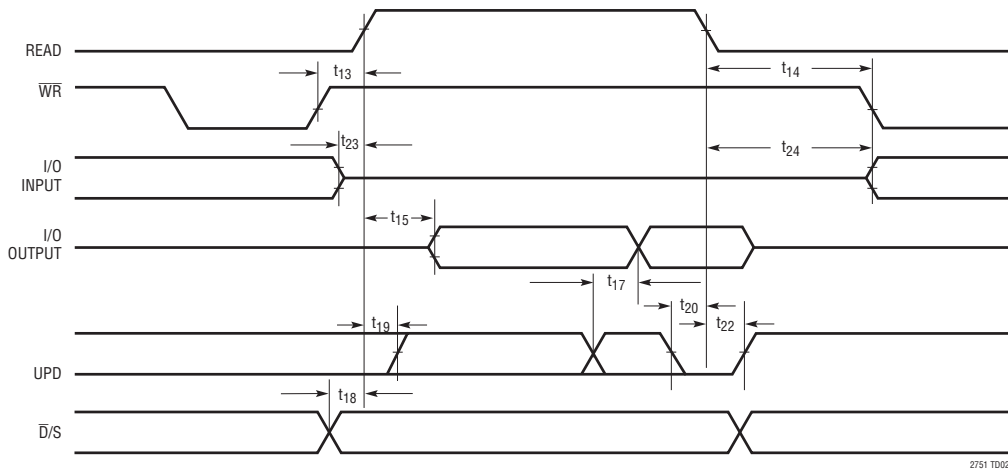

OPERATION

Output Ranges

The LTC2751 is a current-output, parallel-input precision multiplying DAC with software-programmable output ranges. SoftSpan provides two unipolar output ranges (0V to 5V and 0V to 10V), and four bipolar ranges ($\pm 2.5V$, $\pm 5V$, $\pm 10V$ and $-2.5V$ to $7.5V$). These ranges are obtained when an external precision 5V reference is used. When a reference voltage of 2V is used, the SoftSpan ranges become: 0V to 2V, 0V to 4V, $\pm 1V$, $\pm 2V$, $\pm 4V$ and $-1V$ to 3V. The output ranges are linearly scaled for references other than 2V and 5V.

Digital Section

The LTC2751 family has four internal interface registers (see Block Diagram). Two of these—one input and one DAC register—are dedicated to the data I/O port, and two to the span I/O port. Each port is thus double-buffered. The double-buffered feature provides the capability to simultaneously update the span and code, which allows smooth voltage transitions when changing output ranges. It also permits the simultaneous updating of multiple DACs.

OPERATION

Write and Update Operations

The data input register is loaded directly from a 16-bit microprocessor bus by holding the $\overline{D/S}$ pin low and then pulsing the \overline{WR} pin low. The second register (DAC register) is loaded by pulsing the UPD pin high, which copies the data held in the input register into the DAC register. Note that updates always include both data and span; but the DAC register values will not change unless the input register values have been changed by writing.

Loading the span input register is accomplished in a similar manner, by holding the $\overline{D/S}$ pin high and then bringing the \overline{WR} pin low. The span and data register structures are the same except for the number of parallel bits—the span registers have three bits, while the data registers have 12, 14, or 16 bits.

To make both registers transparent for flowthrough mode, tie \overline{WR} low and UPD high. However, this defeats the deglitcher operation and output glitch impulse may increase. The deglitcher is activated on the rising edge of the UPD pin.

The interface also allows the use of the input and DAC registers in a master-slave, or edge-triggered, configuration. This mode of operation occurs when \overline{WR} and UPD are tied together and driven by a single clock signal. The data bits are loaded into the input register on the falling edge of the clock and then loaded into the DAC register on the rising edge.

The separation of data and span for write and read operations makes it possible to control both data and span on one 16-bit wide data bus by allowing span pins S2 to S0 to share bus lines with the data LSBs (D2 to D0). Since no write or read operation includes both span and data, there cannot be a conflict.

The asynchronous clear pin resets the LTC2751 to 0V (zero-, half- or quarter-scale code) in any output range. \overline{CLR} resets both the input and DAC data registers, while leaving the span registers undisturbed.

These devices also have a power-on reset. If configured for SoftSpan operation, the part initializes to zero scale in the 0V to 5V output range. If configured for single-span operation, the part initializes to the zero-volt code in the chosen output range.

Table 1 shows the functions of the LTC2751.

Table 1. Write, Update and Read Functions

READ	$\overline{D/S}$	\overline{WR}	UPD	SPAN I/O	DATA I/O
0	0	0	0	-	Write to Input Register
0	0	0	1	-	Write/Update (Transparent)
0	0	1	0	-	-
0	0	1	1	Update DAC Register	Update DAC Register
0	1	0	0	Write to Input Register	-
0	1	0	1	Write/Update (Transparent)	-
0	1	1	0	-	-
0	1	1	1	Update DAC register	Update DAC Register
1	0	X	0	-	Read Input Register
1	0	X	1	-	Read DAC Register
1	1	X	0	Read Input Register	-
1	1	X	1	Read DAC Register	-

X = Don't Care

Manual Span Configuration

Multiple output ranges are not needed in some applications. To configure the LTC2751 for single-span operation, tie the MSPAN pin to V_{DD} and the $\overline{D/S}$ pin to GND. The desired output range is then specified by the span I/O pins (S0, S1 and S2) as usual, but the pins are programmed by tying directly to GND or V_{DD} (see Figure 1 and Table 2). In this configuration, the part will initialize to the chosen output range at power-up, with $V_{OUT} = 0V$.

When configured for manual span operation, span pin readback is disabled.

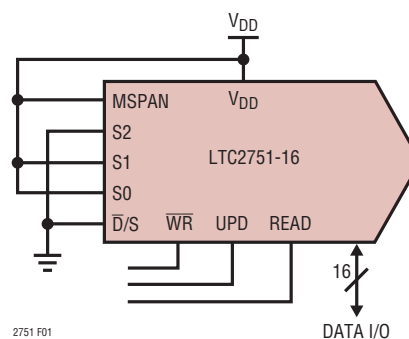

Figure 1. Configuring the LTC2751 for Single-Span Operation ($\pm 10V$ Range)

OPERATION

Table 2. Span Codes

S2	S1	S0	SPAN
0	0	0	Unipolar 0V to 5V
0	0	1	Unipolar 0V to 10V
0	1	0	Bipolar -5V to 5V
0	1	1	Bipolar -10V to 10V
1	0	0	Bipolar -2.5V to 2.5V
1	0	1	Bipolar -2.5V to 7.5V

Codes not shown are reserved and should not be used.

Readback

The contents of any one of the four interface registers can be read back by using the READ pin in conjunction with the \bar{D}/S and UPD pins.

A readback operation is initiated by bringing READ to logic high. The I/O pins, which are high-impedance digital inputs when READ is low, selectively change to low-impedance logic outputs during readback.

The I/O pins comprise two ports, data and span. The data I/O port consists of pins D0-D11, D0-D13 or D0-D15 (LTC2751-12, LTC2751-14 or LTC2751-16, respectively). The span I/O port consists of pins S0, S1 and S2 for all parts.

Each I/O port has one dedicated input register and one dedicated DAC register. The register structure is shown in the Block Diagram.

The \bar{D}/S pin is used to select which I/O port (data or span) is configured to read back the contents of its registers. The unselected I/O port's pins remain high-impedance inputs.

Once the I/O port is selected, its input or DAC register is selected for readback by using the UPD pin. Note that UPD

is a two-function pin. The update function is disabled when READ is high, and the UPD pin instead selects the input or DAC register for readback. Table 1 shows the readback functions for the LTC2751.

The most common readback task is to check the contents of an input register after writing to it, before updating the new data to the DAC register. To do this, bring READ high while holding UPD low. The contents of the selected port's input register are output by the data or span I/O pins.

To read back the contents of a DAC register, bring READ high, then bring UPD high. The contents of the selected data or span DAC register are output by the data or span I/O pins. Note: if no update is desired after the readback operation, UPD must be returned low before bringing READ low, otherwise the UPD pin will revert to its primary function and update the DAC.

System Offset Adjustment

Many systems require compensation for overall system offset. The R_{VOS} offset adjustment pin is provided for this purpose. For noise immunity and ease of adjustment, the control voltage is attenuated to the DAC output:

$$V_{OS} = -0.01 \cdot V(R_{VOS}) \text{ [0V to 5V, } \pm 2.5\text{V spans]}$$

$$V_{OS} = -0.02 \cdot V(R_{VOS}) \text{ [0V to 10V, } \pm 5\text{V,}$$

$$\text{-2.5V to 7.5V spans]}$$

$$V_{OS} = -0.04 \cdot V(R_{VOS}) \text{ [}\pm 10\text{V span]}$$

The nominal input range of this pin is $\pm 5\text{V}$; other reference voltages of up to $\pm 15\text{V}$ may be used if needed. The R_{VOS} pin has an input impedance of $1\text{M}\Omega$. To preserve the settling performance of the LTC2751, this pin should be driven with a Thevenin-equivalent impedance of $10\text{k}\Omega$ or less. If not used, R_{VOS} should be shorted to I_{OUT2} .

OPERATION—EXAMPLES

1. Load $\pm 5V$ range with the output at $0V$. Note that since span and code are updated together, the output, if started at $0V$, will stay there.

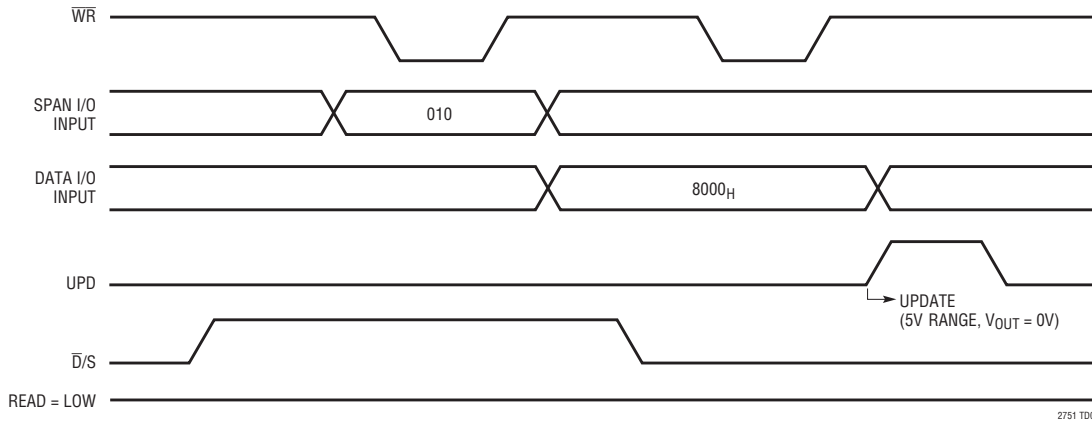

2751 TD03

2. Load $\pm 10V$ range with the output at $5V$, changing to $-5V$.

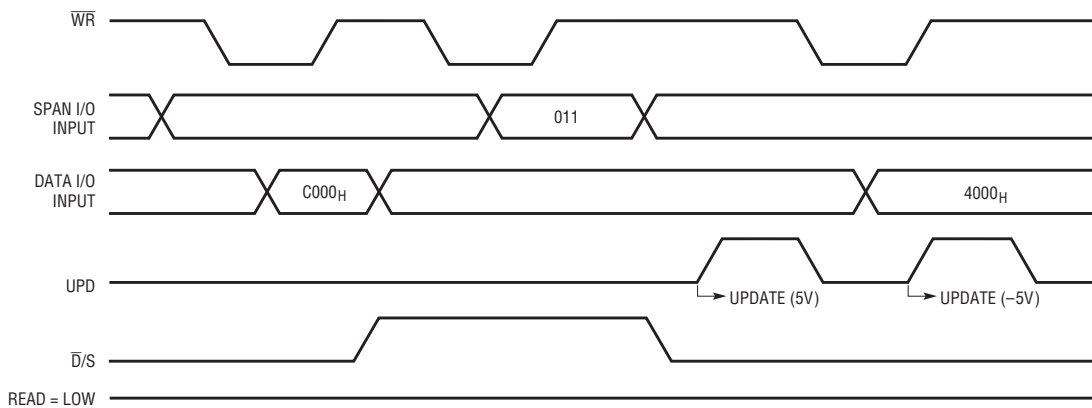

2751 TD04

3. Write and update mid-scale code in $0V$ to $5V$ range ($V_{OUT} = 2.5V$) using readback to check the contents of the input and DAC registers before updating.

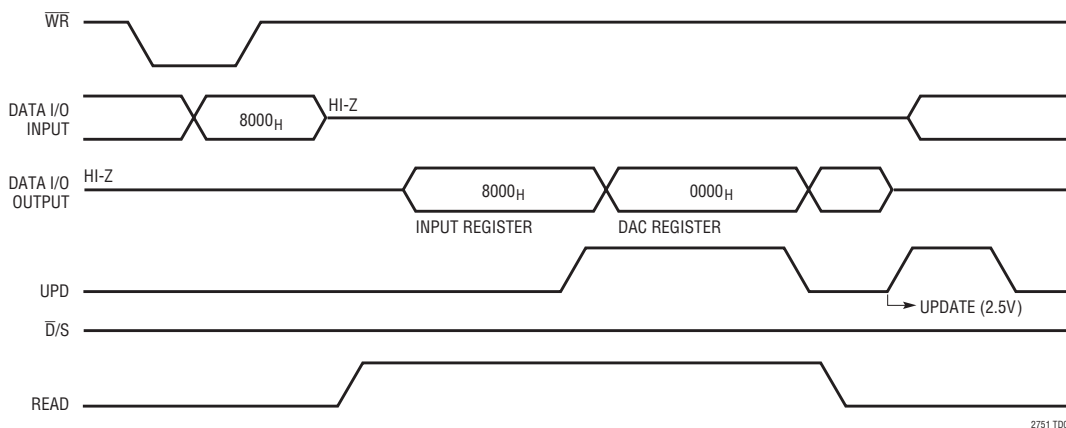

2751 TD05

2751fa

APPLICATIONS INFORMATION

Op Amp Selection

Because of the extremely high accuracy of the 16-bit LTC2751-16, careful thought should be given to op amp selection in order to achieve the exceptional performance of which the part is capable. Fortunately, the sensitivity of INL and DNL to op amp offset has been greatly reduced compared to previous generations of multiplying DACs.

Tables 3 and 4 contain equations for evaluating the effects of op amp parameters on the LTC2751's accuracy

Table 3. Variables for Each Output Range That Adjust the Equations in Table 4

OUTPUT RANGE	A1	A2	A3	A4	A5
5V	1.1	2	1		1
10V	2.2	3	0.5		1.5
±5V	2	2	1	1	1.5
±10V	4	4	0.83	1	2.5
±2.5V	1	1	1.4	1	1
-2.5V to 7.5V	1.9	3	0.7	0.5	1.5

when programmed in a unipolar or bipolar output range. These are the changes the op amp can cause to the INL, DNL, unipolar offset, unipolar gain error, bipolar zero and bipolar gain error. Tables 3 and 4 can also be used to determine the effects of op amp parameters on the LTC2751-14 and the LTC2751-12. However, the results obtained from Tables 3 and 4 are in 16-bit LSBs. Divide these results by 4 (LTC2751-14) and 16 (LTC2751-12) to obtain the correct LSB sizing.

Table 5 contains a partial list of LTC precision op amps recommended for use with the LTC2751. The easy-to-use design equations simplify the selection of op amps to meet the system's specified error budget. Select the amplifier from Table 5 and insert the specified op amp parameters in Table 4. Add up all the errors for each category to determine the effect the op amp has on the accuracy of the part. Arithmetic summation gives an (unlikely) worst-case effect. A root-sum-square (RMS) summation produces a more realistic estimate.

Table 4. Easy-to-Use Equations Determine Op Amp Effects on DAC Accuracy in All Output Ranges (Circuit of Page 1). Subscript 1 Refers to Output Amp, Subscript 2 Refers to Reference Inverting Amp.

OP AMP	INL (LSB)	DNL (LSB)	UNIPOLAR OFFSET (LSB)	BIPOLAR ZERO ERROR (LSB)	UNIPOLAR GAIN ERROR (LSB)	BIPOLAR GAIN ERROR (LSB)
V_{OS1} (mV)	$V_{OS1} \cdot 3.2 \cdot \left(\frac{5V}{V_{REF}}\right)$	$V_{OS1} \cdot 0.82 \cdot \left(\frac{5V}{V_{REF}}\right)$	$A3 \cdot V_{OS1} \cdot 13.2 \cdot \left(\frac{5V}{V_{REF}}\right)$	$A3 \cdot V_{OS1} \cdot 19.8 \cdot \left(\frac{5V}{V_{REF}}\right)$	$V_{OS1} \cdot 13.2 \cdot \left(\frac{5V}{V_{REF}}\right)$	$V_{OS1} \cdot 13.2 \cdot \left(\frac{5V}{V_{REF}}\right)$
I_{B1} (nA)	$I_{B1} \cdot 0.0003 \cdot \left(\frac{5V}{V_{REF}}\right)$	$I_{B1} \cdot 0.00008 \cdot \left(\frac{5V}{V_{REF}}\right)$	$I_{B1} \cdot 0.13 \cdot \left(\frac{5V}{V_{REF}}\right)$	$I_{B1} \cdot 0.13 \cdot \left(\frac{5V}{V_{REF}}\right)$	$I_{B1} \cdot 0.0018 \cdot \left(\frac{5V}{V_{REF}}\right)$	$I_{B1} \cdot 0.0018 \cdot \left(\frac{5V}{V_{REF}}\right)$
A_{VOL1} (V/V)	$A1 \cdot \left(\frac{16.5k}{A_{VOL1}}\right)$	$A2 \cdot \left(\frac{1.5k}{A_{VOL1}}\right)$	0	0	$A5 \cdot \left(\frac{131k}{A_{VOL1}}\right)$	$A5 \cdot \left(\frac{131k}{A_{VOL1}}\right)$
V_{OS2} (mV)	0	0	0	$A4 \cdot \left(V_{OS2} \cdot 13.1 \cdot \left(\frac{5V}{V_{REF}}\right)\right)$	$V_{OS2} \cdot 26.2 \cdot \left(\frac{5V}{V_{REF}}\right)$	$V_{OS2} \cdot 26.2 \cdot \left(\frac{5V}{V_{REF}}\right)$
I_{B2} (mV)	0	0	0	$A4 \cdot \left(I_{B2} \cdot 0.13 \cdot \left(\frac{5V}{V_{REF}}\right)\right)$	$I_{B2} \cdot 0.26 \cdot \left(\frac{5V}{V_{REF}}\right)$	$I_{B2} \cdot 0.26 \cdot \left(\frac{5V}{V_{REF}}\right)$
A_{VOL2} (V/V)	0	0	0	$A4 \cdot \left(\frac{66k}{A_{VOL2}}\right)$	$\left(\frac{131k}{A_{VOL2}}\right)$	$\left(\frac{131k}{A_{VOL2}}\right)$

Table 5. Partial List of LTC Precision Amplifiers Recommended for Use with the LTC2751 with Relevant Specifications

AMPLIFIER	AMPLIFIER SPECIFICATIONS								
	V_{OS} μ V	I_B nA	A_{VOL} V/mV	VOLTAGE NOISE nV/ \sqrt{Hz}	CURRENT NOISE pA/ \sqrt{Hz}	SLEW RATE V/ μ s	GAIN BANDWIDTH PRODUCT MHz	$t_{SETTLING}$ with LTC2751 μ s	POWER DISSIPATION mW
LT1001	25	2	800	10	0.12	0.25	0.8	120	46
LT1097	50	0.35	1000	14	0.008	0.2	0.7	120	11
LT1112 (Dual)	60	0.25	1500	14	0.008	0.16	0.75	115	10.5/Op Amp
LT1124 (Dual)	70	20	4000	2.7	0.3	4.5	12.5	19	69/Op Amp
LT1468	75	10	5000	5	0.6	22	90	2	117
LT1469 (Dual)	125	10	2000	5	0.6	22	90	2	123/Op Amp

2751fa

APPLICATIONS INFORMATION

Op amp offset will contribute mostly to output offset and gain error and has minimal effect on INL and DNL. For the LTC2751-16, a 250 μ V op amp offset will cause about 0.8LSB INL degradation and 0.2LSB DNL degradation with a 5V reference. For the LTC2751 programmed in 5V unipolar mode, the same 250 μ V op amp offset will cause a 3.3LSB zero-scale error and a 3.3LSB gain error.

While not directly addressed by the simple equations in Tables 3 and 4, temperature effects can be handled just as easily for unipolar and bipolar applications. First, consult an op amp's data sheet to find the worst-case V_{OS} and I_B over temperature. Then, plug these numbers in the V_{OS} and I_B equations from Table 4 and calculate the temperature-induced effects.

For applications where fast settling time is important, Application Note 74, "Component and Measurement Advances Ensure 16-Bit DAC Settling Time," offers a thorough discussion of 16-bit DAC settling time and op amp selection.

Precision Voltage Reference Considerations

Much in the same way selecting an operational amplifier for use with the LTC2751 is critical to the performance of the system, selecting a precision voltage reference also requires due diligence. The output voltage of the LTC2751 is directly affected by the voltage reference; thus, any voltage reference error will appear as a DAC output voltage error.

There are three primary error sources to consider when selecting a precision voltage reference for 16-bit applications: output voltage initial tolerance, output voltage temperature coefficient and output voltage noise.

Initial reference output voltage tolerance, if uncorrected, generates a full-scale error term. Choosing a reference with low output voltage initial tolerance, like the LT1236 ($\pm 0.05\%$), minimizes the gain error caused by the reference; however, a calibration sequence that corrects for system zero- and full-scale error is always recommended.

A reference's output voltage temperature coefficient affects not only the full-scale error, but can also affect the circuit's INL and DNL performance. If a reference is chosen with a loose output voltage temperature coefficient, then the DAC output voltage along its transfer characteristic will

be very dependent on ambient conditions. Minimizing the error due to reference temperature coefficient can be achieved by choosing a precision reference with a low output voltage temperature coefficient and/or tightly controlling the ambient temperature of the circuit to minimize temperature gradients.

As precision DAC applications move to 16-bit and higher performance, reference output voltage noise may contribute a dominant share of the system's noise floor. This in turn can degrade system dynamic range and signal-to-noise ratio. Care should be exercised in selecting a voltage reference with as low an output noise voltage as practical for the system resolution desired. Precision voltage references, like the LT1236, produce low output noise in the 0.1Hz to 10Hz region, well below the 16-bit LSB level in 5V or 10V full-scale systems. However, as the circuit bandwidths increase, filtering the output of the reference may be required to minimize output noise.

Table 6. Partial List of LTC Precision References Recommended for Use with the LTC2751 with Relevant Specifications

REFERENCE	INITIAL TOLERANCE	TEMPERATURE DRIFT	0.1Hz to 10Hz NOISE
LT1019A-5, LT1019A-10	$\pm 0.05\%$	5ppm/ $^{\circ}$ C	12 μ V _{P-P}
LT1236A-5, LT1236A-10	$\pm 0.05\%$	5ppm/ $^{\circ}$ C	3 μ V _{P-P}
LT1460A-5, LT1460A-10	$\pm 0.075\%$	10ppm/ $^{\circ}$ C	20 μ V _{P-P}
LT1790A-2.5	$\pm 0.05\%$	10ppm/ $^{\circ}$ C	12 μ V _{P-P}

Grounding

As with any high resolution converter, clean grounding is important. A low impedance analog ground plane and star grounding techniques should be used. I_{OUT2} must be tied to the star ground with as low a resistance as possible. When it is not possible to locate star ground close to I_{OUT2} , a low resistance trace should be used to route this pin to star ground. This minimizes the voltage drop from this pin to ground caused by the code dependent current flowing to ground. When the resistance of this circuit board trace becomes greater than 1 Ω , a force/sense amplified configuration should be used to drive this pin (see Figure 2). This preserves the excellent accuracy (1LSB INL and DNL) of the LTC2751-16.

TYPICAL APPLICATIONS

16-Bit DAC with Software-Selectable Ranges

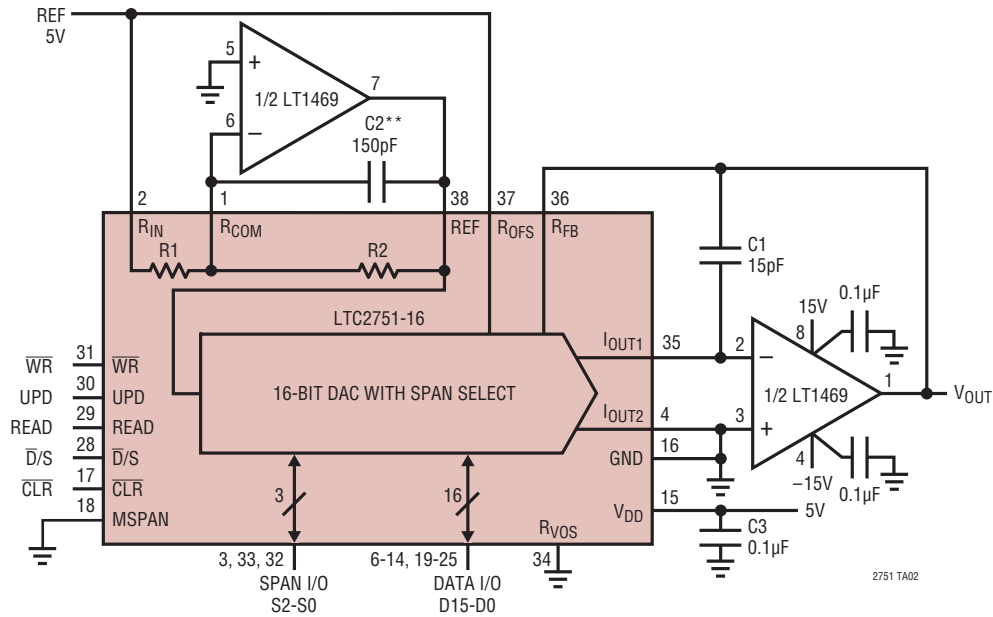

**FOR MULTIPLYING APPLICATIONS C2 = 15pF

2751 TA02

REVISION HISTORY

REV	DATE	DESCRIPTION	PAGE NUMBER
A	11/12	Correction made in the Typical Application diagram.	1, 18

Looking for pricing, stock, or lifecycle information?

Click below to explore more details on WIN SOURCE:

 [View LTC2751BIUHF-16#TRPBF on WIN SOURCE](#)

 [Linear Technology](#) Information

Optimize Your Supply Chain with WIN SOURCE Solutions

-  Global Sourcing Solution
-  Obsolete Management
-  Cost Control Management
-  Shortage Management
-  Alternative Solution
-  Excess Inventory Management