



**THE DATASHEET OF  
LTC2606IDD#PBF**



### FEATURES

- **Smallest Pin-Compatible Single DACs:**  
**LTC2606: 16 Bits**  
**LTC2616: 14 Bits**  
**LTC2626: 12 Bits**
- **Guaranteed 16-Bit Monotonic Over Temperature**
- **27 Selectable Addresses**
- 400kHz I<sup>2</sup>C Interface
- Wide 2.7V to 5.5V Supply Range
- Low Power Operation: 270µA at 3V
- Power Down to 1µA, Max
- High Rail-to-Rail Output Drive (±15mA, Min)
- Double-Buffered Data Latches
- Asynchronous DAC Update Pin
- LTC2606/LTC2616/LTC2626: Power-On Reset to Zero Scale
- LTC2606-1/LTC2616-1/LTC2626-1: Power-On Reset to Mid-Scale
- Tiny (3mm × 3mm) 10-Lead DFN Package

### APPLICATIONS

- Mobile Communications
- Process Control and Industrial Automation
- Instrumentation
- Automatic Test Equipment

### DESCRIPTION

The **LTC<sup>®</sup>2606/LTC2616/LTC2626** are single 16-, 14- and 12-bit, 2.7V-to-5.5V rail-to-rail voltage output DACs in a 10-lead DFN package. They have built-in high performance output buffers and are guaranteed monotonic.

These parts establish new board-density benchmarks for 16- and 14-bit DACs and advance performance standards for output drive and load regulation in single-supply, voltage-output DACs.

The parts use a 2-wire, I<sup>2</sup>C compatible serial interface. The LTC2606/LTC2616/LTC2626 operate in both the standard mode (clock rate of 100kHz) and the fast mode (clock rate of 400kHz). An asynchronous DAC update pin (LDAC) is also included.

The LTC2606/LTC2616/LTC2626 incorporate a power-on reset circuit. During power-up, the voltage outputs rise less than 10mV above zero scale; and after power-up, they stay at zero scale until a valid write and update take place. The power-on reset circuit resets the LTC2606-1/LTC2616-1/LTC2626-1 to mid-scale. The voltage outputs stay at mid-scale until a valid write and update take place.

LT, LT, LTC, LTM, Linear Technology and the Linear logo are registered trademarks of Analog Devices, Inc. All other trademarks are the property of their respective owners.

### TYPICAL APPLICATION

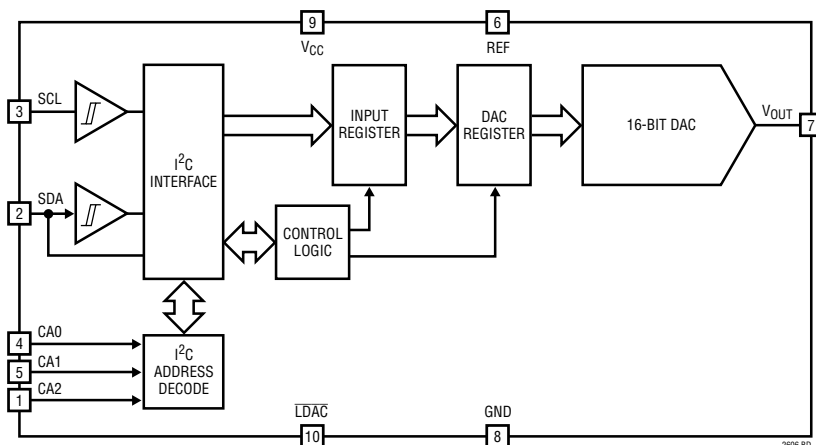

**Differential Nonlinearity  
(LTC2606)**

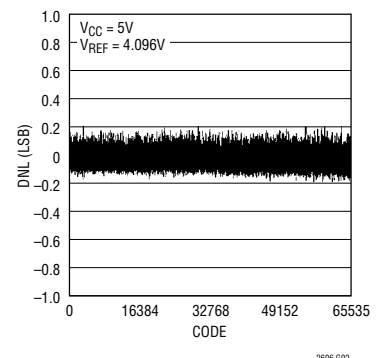

# LTC2606/LTC2616/LTC2626

## ABSOLUTE MAXIMUM RATINGS

(Note 1)

Any Pin to GND .....	-0.3V to 6V
Any Pin to $V_{CC}$ .....	-6V to 0.3V
Maximum Junction Temperature.....	125°C
Storage Temperature Range.....	-65°C to 125°C
Lead Temperature (Soldering, 10 sec) .....	300°C
Operating Temperature Range:	
LTC2606C/LTC2616C/LTC2626C	
LTC2606-1C/LTC2616-1C/LTC2626-1C .....	0°C to 70°C
LTC2606I/LTC2616I/LTC2626I	
LTC2606-1I/LTC2616-1I/LTC2626-1I.....	-40°C to 85°C

## PIN CONFIGURATION

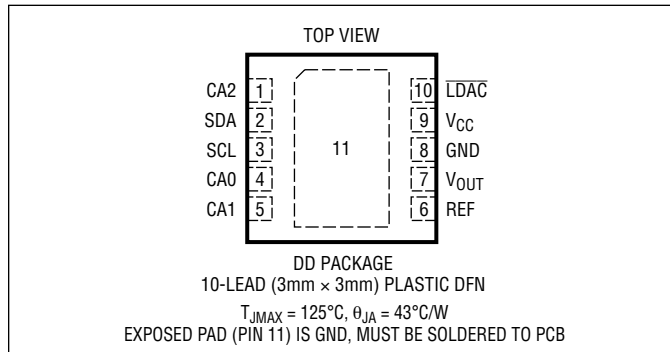

## ORDER INFORMATION <http://www.linear.com/product/LTC2606#orderinfo>

LEAD FREE FINISH	TAPE AND REEL	PART MARKING*	PACKAGE DESCRIPTION	TEMPERATURE RANGE
LTC2606CDD#PBF	LTC2606CDD#TRPBF	LAJX	10-Lead (3mm × 3mm) Plastic DFN	0°C to 70°C
LTC2606IDD#PBF	LTC2606IDD#TRPBF	LAJX	10-Lead (3mm × 3mm) Plastic DFN	-40°C to 85°C
LTC2606CDD-1#PBF	LTC2606CDD-1#TRPBF	LAJW	10-Lead (3mm × 3mm) Plastic DFN	0°C to 70°C
LTC2606IDD-1#PBF	LTC2606IDD-1#TRPBF	LAJW	10-Lead (3mm × 3mm) Plastic DFN	-40°C to 85°C
LTC2616CDD#PBF	LTC2616CDD#TRPBF	LBPQ	10-Lead (3mm × 3mm) Plastic DFN	0°C to 70°C
LTC2616IDD#PBF	LTC2616IDD#TRPBF	LBPQ	10-Lead (3mm × 3mm) Plastic DFN	-40°C to 85°C
LTC2616CDD-1#PBF	LTC2616CDD-1#TRPBF	LBPR	10-Lead (3mm × 3mm) Plastic DFN	0°C to 70°C
LTC2616IDD-1#PBF	LTC2616IDD-1#TRPBF	LBPR	10-Lead (3mm × 3mm) Plastic DFN	-40°C to 85°C
LTC2626CDD#PBF	LTC2626CDD#TRPBF	LBPS	10-Lead (3mm × 3mm) Plastic DFN	0°C to 70°C
LTC2626IDD#PBF	LTC2626IDD#TRPBF	LBPS	10-Lead (3mm × 3mm) Plastic DFN	-40°C to 85°C
LTC2626CDD-1#PBF	LTC2626CDD-1#TRPBF	LBPT	10-Lead (3mm × 3mm) Plastic DFN	0°C to 70°C
LTC2626IDD-1#PBF	LTC2626IDD-1#TRPBF	LBPT	10-Lead (3mm × 3mm) Plastic DFN	-40°C to 85°C
LEAD FREE FINISH	TAPE AND REEL	PART MARKING*	PACKAGE DESCRIPTION	TEMPERATURE RANGE
LTC2606CDD	LTC2606CDD#TR	LAJX	10-Lead (3mm × 3mm) Plastic DFN	0°C to 70°C
LTC2606IDD	LTC2606IDD#TR	LAJX	10-Lead (3mm × 3mm) Plastic DFN	-40°C to 85°C
LTC2606CDD-1	LTC2606CDD-1#TR	LAJW	10-Lead (3mm × 3mm) Plastic DFN	0°C to 70°C
LTC2606IDD-1	LTC2606IDD-1#TR	LAJW	10-Lead (3mm × 3mm) Plastic DFN	-40°C to 85°C
LTC2616CDD	LTC2616CDD#TR	LBPQ	10-Lead (3mm × 3mm) Plastic DFN	0°C to 70°C
LTC2616IDD	LTC2616IDD#TR	LBPQ	10-Lead (3mm × 3mm) Plastic DFN	-40°C to 85°C
LTC2616CDD-1	LTC2616CDD-1#TR	LBPR	10-Lead (3mm × 3mm) Plastic DFN	0°C to 70°C
LTC2616IDD-1	LTC2616IDD-1#TR	LBPR	10-Lead (3mm × 3mm) Plastic DFN	-40°C to 85°C
LTC2626CDD	LTC2626CDD#TR	LBPS	10-Lead (3mm × 3mm) Plastic DFN	0°C to 70°C
LTC2626IDD	LTC2626IDD#TR	LBPS	10-Lead (3mm × 3mm) Plastic DFN	-40°C to 85°C
LTC2626CDD-1	LTC2626CDD-1#TR	LBPT	10-Lead (3mm × 3mm) Plastic DFN	0°C to 70°C
LTC2626IDD-1	LTC2626IDD-1#TR	LBPT	10-Lead (3mm × 3mm) Plastic DFN	-40°C to 85°C

Consult LTC Marketing for parts specified with wider operating temperature ranges. \*Temperature grades are identified by a label on the shipping container.

For more information on lead free part marking, go to: <http://www.linear.com/leadfree/>

For more information on tape and reel specifications, go to: <http://www.linear.com/tapeandreeel/>. Some packages are available in 500 unit reels through designated sales channels with #TRMPBF suffix.

26061626fc

**ELECTRICAL CHARACTERISTICS** The ● denotes specifications which apply over the full operating temperature range, otherwise specifications are at  $T_A = 25^\circ\text{C}$ .  $V_{REF} = 4.096\text{V}$  ( $V_{CC} = 5\text{V}$ ),  $V_{REF} = 2.048\text{V}$  ( $V_{CC} = 2.7\text{V}$ ),  $V_{OUT}$  unloaded, unless otherwise noted.

SYMBOL	PARAMETER	CONDITIONS	LTC2626/LTC2626-1			LTC2616/LTC2616-1			LTC2606/LTC2606-1			UNITS	
			MIN	TYP	MAX	MIN	TYP	MAX	MIN	TYP	MAX		
<b>DC Performance</b>													
	Resolution		●	12			14			16		Bits	
	Monotonicity	(Note 2)	●	12			14			16		Bits	
DNL	Differential Nonlinearity	(Note 2)	●			$\pm 0.5$			$\pm 1$		$\pm 1$	LSB	
INL	Integral Nonlinearity	(Note 2)	●		$\pm 1$	$\pm 4$		$\pm 4$	$\pm 16$		$\pm 14$	$\pm 64$	LSB
	Load Regulation	$V_{REF} = V_{CC} = 5\text{V}$ , Mid-Scale $I_{OUT} = 0\text{mA}$ to $15\text{mA}$ Sourcing $I_{OUT} = 0\text{mA}$ to $15\text{mA}$ Sinking	●	0.025	0.125		0.1	0.5		0.5	2	LSB/mA	
			●	0.05	0.125		0.2	0.5		0.7	2	LSB/mA	
		$V_{REF} = V_{CC} = 2.7\text{V}$ , Mid-Scale $I_{OUT} = 0\text{mA}$ to $7.5\text{mA}$ Sourcing $I_{OUT} = 0\text{mA}$ to $7.5\text{mA}$ Sinking	●	0.05	0.25		0.2	1		0.9	4	LSB/mA	
			●	0.1	0.25		0.4	1		1.5	4	LSB/mA	
ZSE	Zero-Scale Error	Code = 0	●	1	9		1	9		1	9	mV	
$V_{OS}$	Offset Error	(Note 5)	●	$\pm 1$	$\pm 9$		$\pm 1$	$\pm 9$		$\pm 1$	$\pm 9$	mV	
	$V_{OS}$ Temperature Coefficient			$\pm 5$			$\pm 5$			$\pm 5$		$\mu\text{V}/^\circ\text{C}$	
GE	Gain Error		●	$\pm 0.1$	$\pm 0.7$		$\pm 0.1$	$\pm 0.7$		$\pm 0.1$	$\pm 0.7$	%FSR	
	Gain Temperature Coefficient			$\pm 8.5$			$\pm 8.5$			$\pm 8.5$		$\text{ppm}/^\circ\text{C}$	

# LTC2606/LTC2616/LTC2626

**ELECTRICAL CHARACTERISTICS** The ● denotes specifications which apply over the full operating temperature range, otherwise specifications are at  $T_A = 25^\circ\text{C}$ . REF = 4.096V ( $V_{CC} = 5\text{V}$ ), REF = 2.048V ( $V_{CC} = 2.7\text{V}$ ),  $V_{OUT}$  unloaded, unless otherwise noted. (Note 11)

SYMBOL	PARAMETER	CONDITIONS		MIN	TYP	MAX	UNITS
PSR	Power Supply Rejection	$V_{CC} = \pm 10\%$			-81		dB
$R_{OUT}$	DC Output Impedance	$V_{REF} = V_{CC} = 5\text{V}$ , Mid-Scale; $-15\text{mA} \leq I_{OUT} \leq 15\text{mA}$ $V_{REF} = V_{CC} = 2.7\text{V}$ , Mid-Scale; $-7.5\text{mA} \leq I_{OUT} \leq 7.5\text{mA}$	● ●		0.05 0.06	0.15 0.15	$\Omega$ $\Omega$
$I_{SC}$	Short-Circuit Output Current	$V_{CC} = 5.5\text{V}$ , $V_{REF} = 5.5\text{V}$ Code: Zero-Scale; Forcing Output to $V_{CC}$ Code: Full-Scale; Forcing Output to GND	● ●	15 15	34 36	60 60	mA mA
		$V_{CC} = 2.7\text{V}$ , $V_{REF} = 2.7\text{V}$ Code: Zero-Scale; Forcing Output to $V_{CC}$ Code: Full-Scale; Forcing Output to GND	● ●	7.5 7.5	22 29	50 50	mA mA

## Reference Input

	Input Voltage Range		●	0		$V_{CC}$	V
	Resistance	Normal Mode	●	88	124	160	k $\Omega$
	Capacitance				15		pF
$I_{REF}$	Reference Current, Power Down Mode	DAC Powered Down	●		0.001	1	$\mu\text{A}$

## Power Supply

$V_{CC}$	Positive Supply Voltage	For Specified Performance	●	2.7		5.5	V
$I_{CC}$	Supply Current	$V_{CC} = 5\text{V}$ (Note 3)	●		0.340	0.5	mA
		$V_{CC} = 3\text{V}$ (Note 3)	●		0.27	0.4	mA
		DAC Powered Down (Note 3) $V_{CC} = 5\text{V}$	●		0.35	1	$\mu\text{A}$
		DAC Powered Down (Note 3) $V_{CC} = 3\text{V}$	●		0.10	1	$\mu\text{A}$

## Digital I/O (Note 11)

$V_{IL}$	Low Level Input Voltage (SDA and SCL)		●	-0.5		$0.3V_{CC}$	V
$V_{IH}$	High Level Input Voltage (SDA and SCL)	(Note 8)	●	$0.7V_{CC}$			V
$V_{IL(LDAC)}$	Low Level Input Voltage ( $\overline{LDAC}$ )	$V_{CC} = 4.5\text{V}$ to $5.5\text{V}$	●			0.8	V
		$V_{CC} = 2.7\text{V}$ to $5.5\text{V}$	●			0.6	V
$V_{IH(LDAC)}$	High Level Input Voltage ( $\overline{LDAC}$ )	$V_{CC} = 2.7\text{V}$ to $5.5\text{V}$	●	2.4			V
		$V_{CC} = 2.7\text{V}$ to $3.6\text{V}$	●	2.0			V
$V_{IL(CAn)}$	Low Level Input Voltage on $CA_n$ ( $n = 0, 1, 2$ )	See Test Circuit 1	●			$0.15V_{CC}$	V
$V_{IH(CAn)}$	High Level Input Voltage on $CA_n$ ( $n = 0, 1, 2$ )	See Test Circuit 1	●	$0.85V_{CC}$			V
$R_{INH}$	Resistance from $CA_n$ ( $n = 0, 1, 2$ ) to $V_{CC}$ to Set $CA_n = V_{CC}$	See Test Circuit 2	●			10	k $\Omega$
$R_{INL}$	Resistance from $CA_n$ ( $n = 0, 1, 2$ ) to GND to Set $CA_n = \text{GND}$	See Test Circuit 2	●			10	k $\Omega$
$R_{INF}$	Resistance from $CA_n$ ( $n = 0, 1, 2$ ) to $V_{CC}$ or GND to Set $CA_n = \text{Float}$	See Test Circuit 2	●	2			M $\Omega$
$V_{OL}$	Low Level Output Voltage	Sink Current = 3mA	●	0		0.4	V
$t_{OF}$	Output Fall Time	$V_O = V_{IH(MIN)}$ to $V_O = V_{IL(MAX)}$ , $C_B = 10\text{pF}$ to $400\text{pF}$ (Note 9)	●	$20 + 0.1C_B$		250	ns
$t_{SP}$	Pulse Width of Spikes Suppressed by Input Filter		●	0		50	ns
$I_{IN}$	Input Leakage	$0.1V_{CC} \leq V_{IN} \leq 0.9V_{CC}$	●			1	$\mu\text{A}$
$C_{IN}$	I/O Pin Capacitance	(Note 4)	●			10	pF
$C_B$	Capacitive Load for Each Bus Line		●			400	pF
$C_{CAX}$	External Capacitive Load on Address Pins $CA_n$ ( $n = 0, 1, 2$ )		●			10	pF

26061626fc

**ELECTRICAL CHARACTERISTICS** The ● denotes specifications which apply over the full operating temperature range, otherwise specifications are at T<sub>A</sub> = 25°C. REF = 4.096V (V<sub>CC</sub> = 5V), REF = 2.048V (V<sub>CC</sub> = 2.7V), V<sub>OUT</sub> unloaded, unless otherwise noted.

SYMBOL	PARAMETER	CONDITIONS	LTC2626/LTC2626-1			LTC2616/LTC2616-1			LTC2606/LTC2606-1			UNITS
			MIN	TYP	MAX	MIN	TYP	MAX	MIN	TYP	MAX	
<b>AC Performance</b>												
t <sub>S</sub>	Settling Time (Note 6)	±0.024% (±1LSB at 12 Bits) ±0.006% (±1LSB at 14 Bits) ±0.0015% (±1LSB at 16 Bits)	7			7 9			7 9 10			μs μs μs
	Settling Time for 1LSB Step (Note 7)	±0.024% (±1LSB at 12 Bits) ±0.006% (±1LSB at 14 Bits) ±0.0015% (±1LSB at 16 Bits)	2.7			2.7 4.8			2.7 4.8 5.2			μs μs μs
	Voltage Output Slew Rate		0.75			0.75			0.75			V/μs
	Capacitive Load Driving		1000			1000			1000			pF
	Glitch Impulse	At Mid-Scale Transition	12			12			12			nV•s
	Multiplying Bandwidth		180			180			180			kHz
e <sub>n</sub>	Output Voltage Noise Density	At f = 1kHz At f = 10kHz	120 100			120 100			120 100			nV/√Hz nV/√Hz
	Output Voltage Noise	0.1Hz to 10Hz	15			15			15			μV <sub>P-P</sub>

**TIMING CHARACTERISTICS** The ● denotes specifications which apply over the full operating temperature range, otherwise specifications are at T<sub>A</sub> = 25°C. (See Figure 1) (Notes 10, 11)

SYMBOL	PARAMETER	CONDITIONS	MIN	TYP	MAX	UNITS
<b>V<sub>CC</sub> = 2.7V to 5.5V</b>						
f <sub>SCL</sub>	SCL Clock Frequency		●	0	400	kHz
t <sub>HD(STA)</sub>	Hold Time (Repeated) Start Condition		●	0.6		μs
t <sub>LOW</sub>	Low Period of the SCL Clock Pin		●	1.3		μs
t <sub>HIGH</sub>	High Period of the SCL Clock Pin		●	0.6		μs
t <sub>SU(STA)</sub>	Set-Up Time for a Repeated Start Condition		●	0.6		μs
t <sub>HD(DAT)</sub>	Data Hold Time		●	0	0.9	μs
t <sub>SU(DAT)</sub>	Data Set-Up Time		●	100		ns
t <sub>r</sub>	Rise Time of Both SDA and SCL Signals	(Note 9)	●	20 + 0.1C <sub>B</sub>	300	ns
t <sub>f</sub>	Fall Time of Both SDA and SCL Signals	(Note 9)	●	20 + 0.1C <sub>B</sub>	300	ns
t <sub>SU(STO)</sub>	Set-Up Time for Stop Condition		●	0.6		μs
t <sub>BUF</sub>	Bus Free Time Between a Stop and Start Condition		●	1.3		μs
t <sub>1</sub>	Falling Edge of 9th Clock of the 3rd Input Byte to LDAC High or Low Transition		●	400		ns
t <sub>2</sub>	LDAC Low Pulse Width		●	20		ns

**Note 1:** Stresses beyond those listed under Absolute Maximum Ratings may cause permanent damage to the device. Exposure to any Absolute Maximum Rating condition for extended periods may affect device reliability and lifetime.

**Note 2:** Linearity and monotonicity are defined from code k<sub>L</sub> to code 2<sup>N</sup> - 1, where N is the resolution and k<sub>L</sub> is given by k<sub>L</sub> = 0.016(2<sup>N</sup>/V<sub>REF</sub>), rounded to the nearest whole code. For V<sub>REF</sub> = 4.096V and N = 16, k<sub>L</sub> = 256 and linearity is defined from code 256 to code 65,535.

**Note 3:** Digital inputs at 0V or V<sub>CC</sub>.

**Note 4:** Guaranteed by design and not production tested.

**Note 5:** Inferred from measurement at code 256 (LTC2606/LTC2606-1),

code 64 (LTC2616/LTC2616-1) or code 16 (LTC2626/LTC2626-1) and at full-scale.

**Note 6:** V<sub>CC</sub> = 5V, V<sub>REF</sub> = 4.096V. DAC is stepped 1/4-scale to 3/4-scale and 3/4-scale to 1/4-scale. Load is 2k in parallel with 200pF to GND.

**Note 7:** V<sub>CC</sub> = 5V, V<sub>REF</sub> = 4.096V. DAC is stepped ±1LSB between half scale and half scale - 1. Load is 2k in parallel with 200pF to GND.

**Note 8:** Maximum V<sub>IH</sub> = V<sub>CC(MAX)</sub> + 0.5V

**Note 9:** C<sub>B</sub> = capacitance of one bus line in pF

**Note 10:** All values refer to V<sub>IH(MIN)</sub> and V<sub>IL(MAX)</sub> levels.

**Note 11:** These specifications apply to LTC2606/LTC2606-1, LTC2616/LTC2616-1, LTC2626/LTC2626-1.

# LTC2606/LTC2616/LTC2626

## TYPICAL PERFORMANCE CHARACTERISTICS

### LTC2606

**Integral Nonlinearity (INL)**

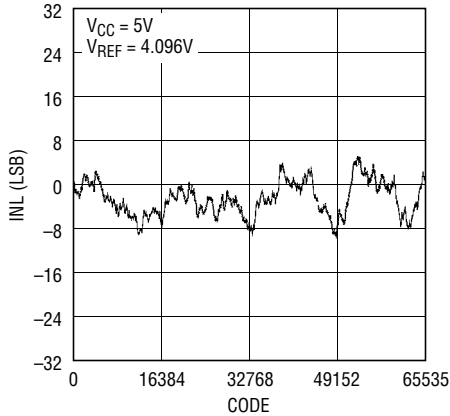

2606 G01

**Differential Nonlinearity (DNL)**

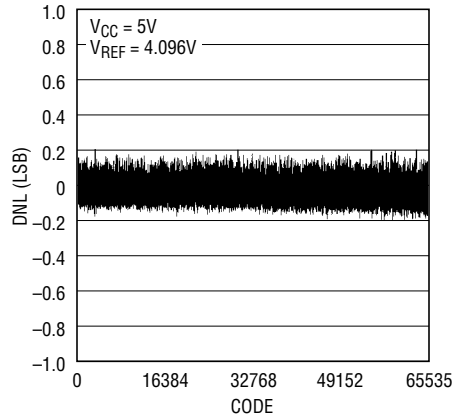

2606 G02

**INL vs Temperature**

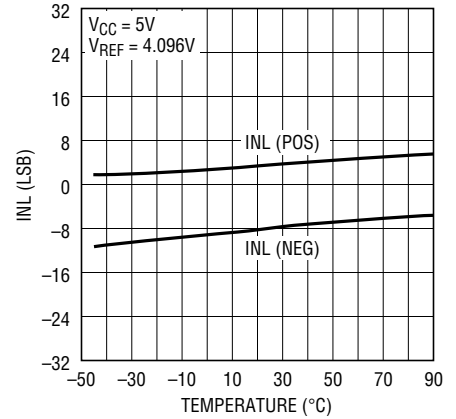

2606 G03

**DNL vs Temperature**

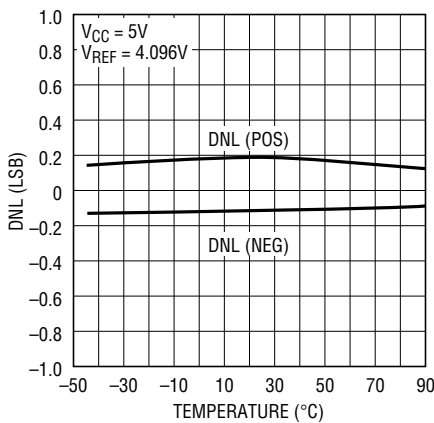

2606 G04

**INL vs VREF**

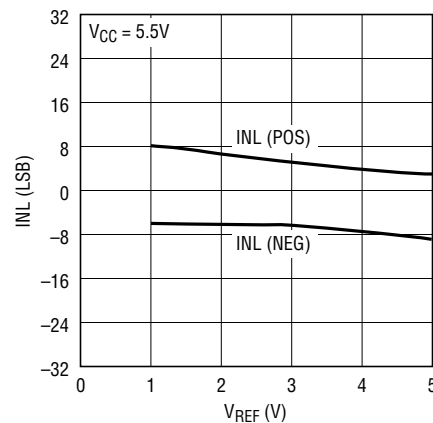

2606 G05

**DNL vs VREF**

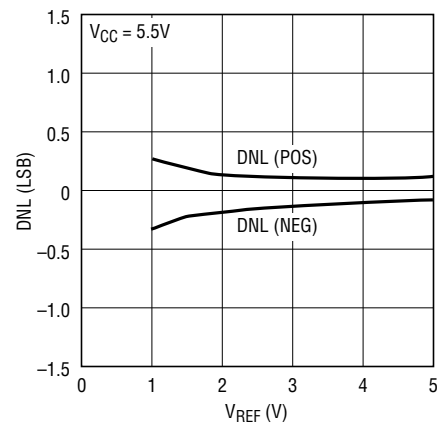

2606 G06

**Settling to  $\pm 1$ LSB**

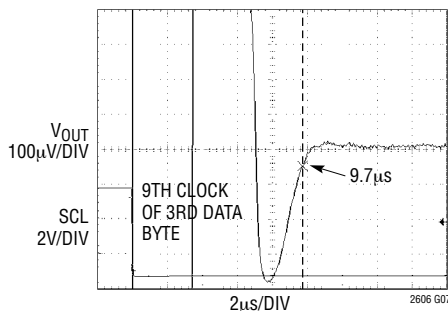

2606 G07

$V_{CC} = 5V$ ,  $V_{REF} = 4.096V$   
1/4-SCALE TO 3/4-SCALE STEP  
 $R_L = 2k$ ,  $C_L = 200pF$   
AVERAGE OF 2048 EVENTS

**Settling of Full-Scale Step**

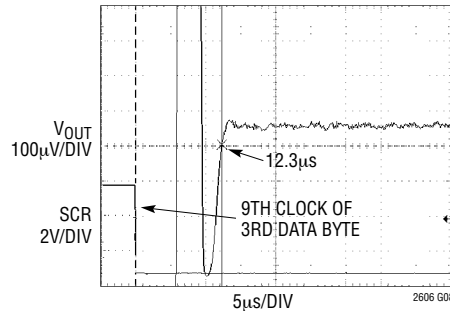

2606 G08

SETTLING TO  $\pm 1$ LSB  
 $V_{CC} = 5V$ ,  $V_{REF} = 4.096V$   
CODE 512 TO 65535 STEP  
AVERAGE OF 2048 EVENTS

# TYPICAL PERFORMANCE CHARACTERISTICS

## LTC2616

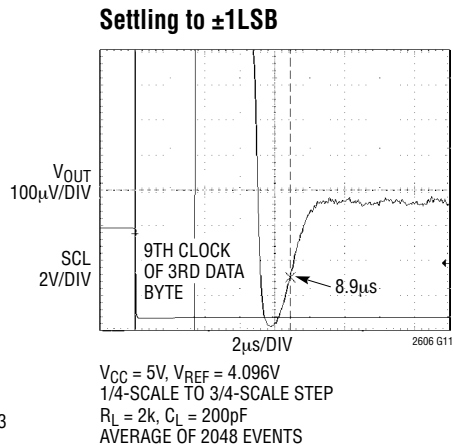
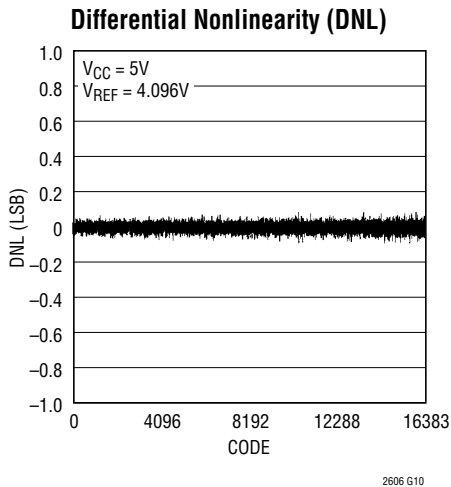
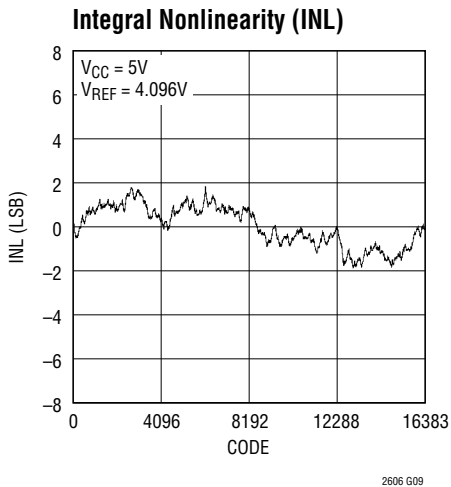

## LTC2626

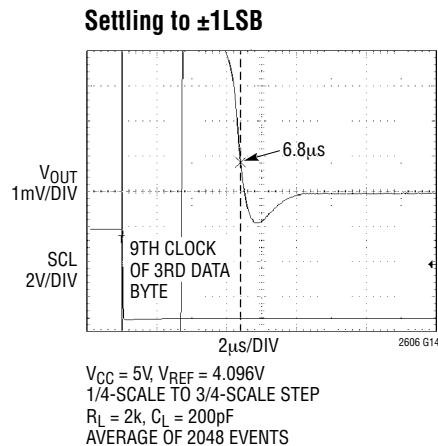
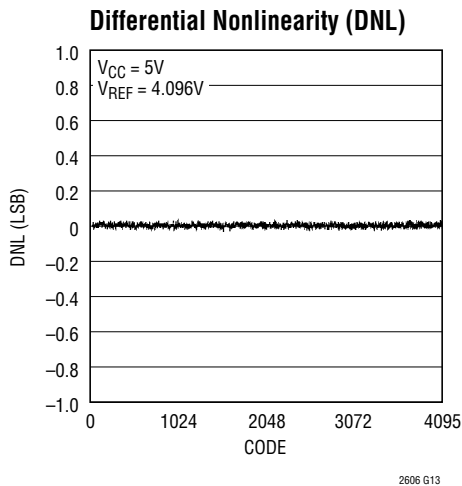
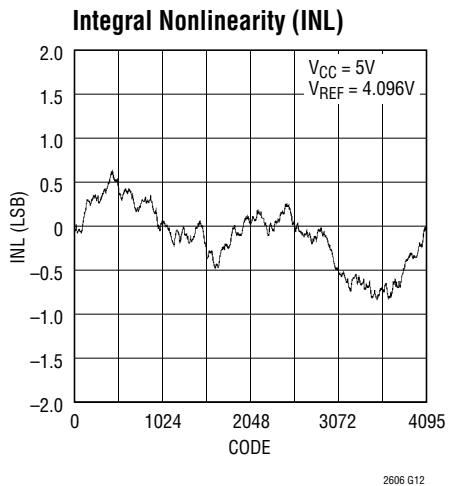

## LTC2606/LTC2616/LTC2626

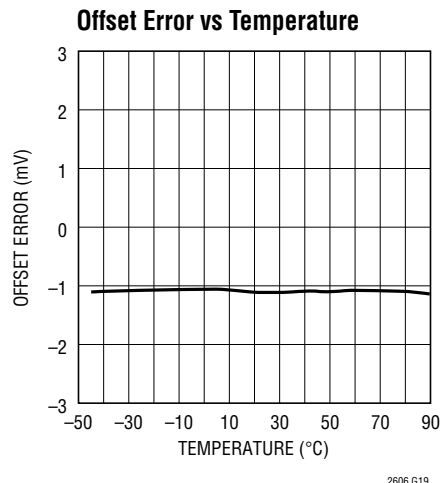
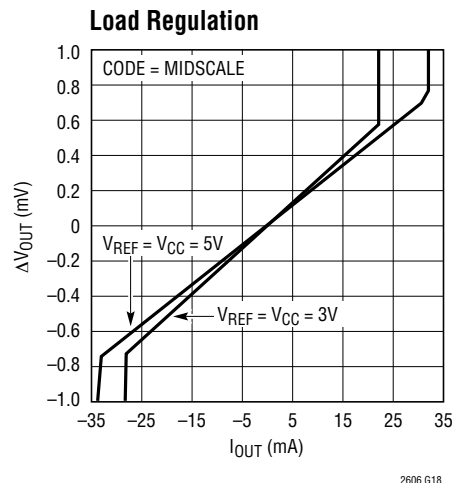
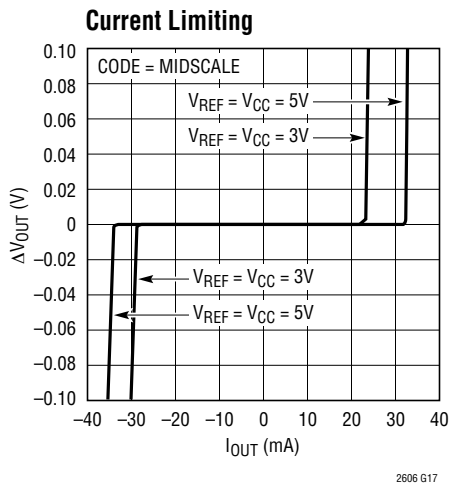

# LTC2606/LTC2616/LTC2626

## TYPICAL PERFORMANCE CHARACTERISTICS

### LTC2606/LTC2616/LTC2626

**Zero-Scale Error vs Temperature**

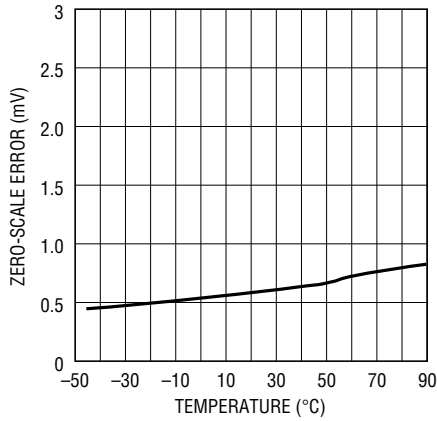

2606 G20

**Gain Error vs Temperature**

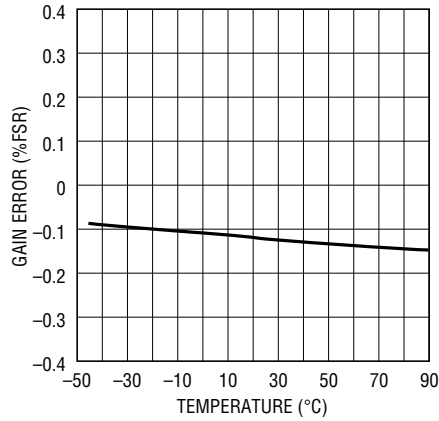

2606 G21

**Offset Error vs  $V_{CC}$**

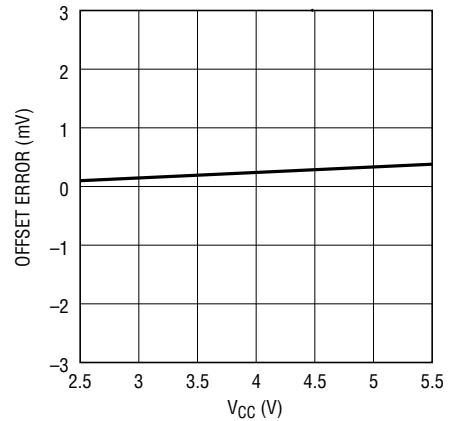

2606 G22

**Gain Error vs  $V_{CC}$**

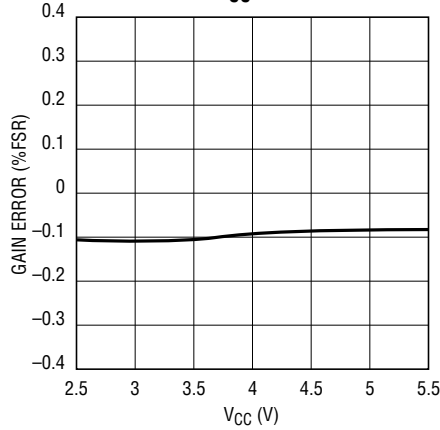

2606 G23

**$I_{CC}$  Shutdown vs  $V_{CC}$**

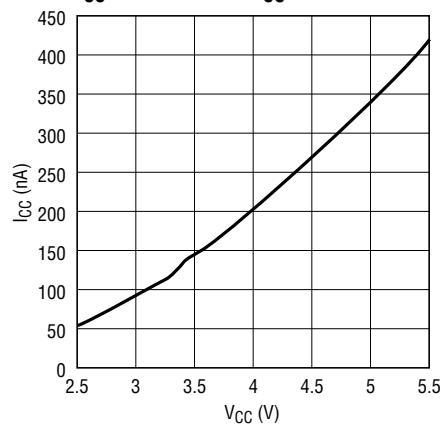

2606 G24

**Large-Signal Response**

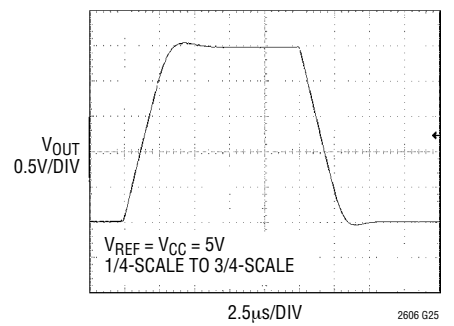

2606 G25

**Mid-Scale Glitch Impulse**

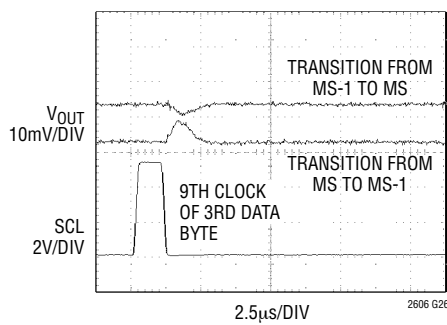

2606 G26

**Power-On Reset Glitch**

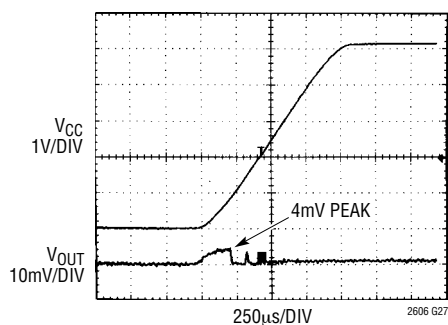

2606 G27

**Headroom at Rails vs Output Current**

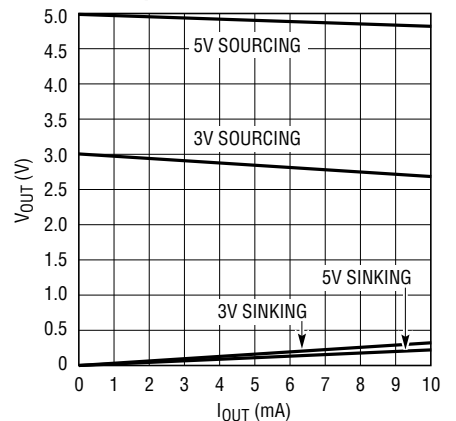

2606 G28

26061626fc

# TYPICAL PERFORMANCE CHARACTERISTICS

## LTC2606/LTC2616/LTC2626

**Power-On Reset to Mid-Scale**



**Supply Current vs Logic Voltage**

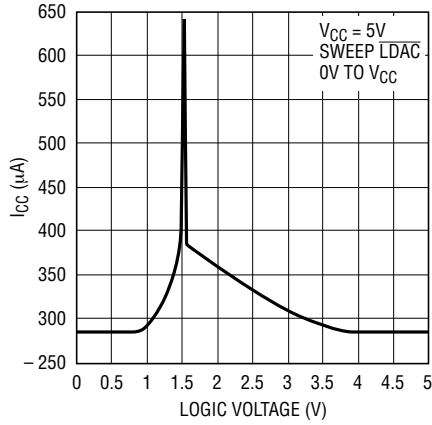

**Supply Current vs Logic Voltage**



**Multiplying Bandwidth**

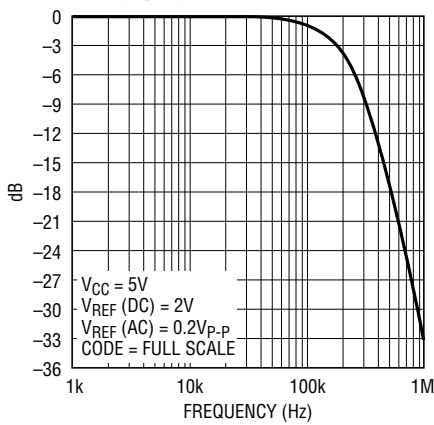

**Output Voltage Noise, 0.1Hz to 10Hz**

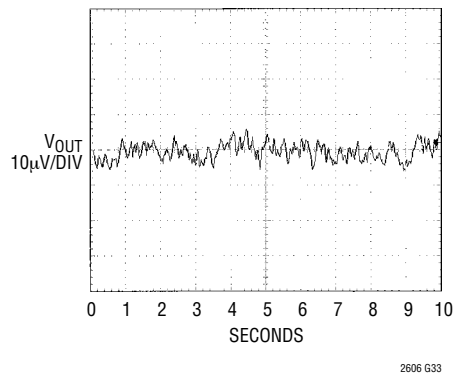

**Short-Circuit Output Current vs VOUT (Sinking)**

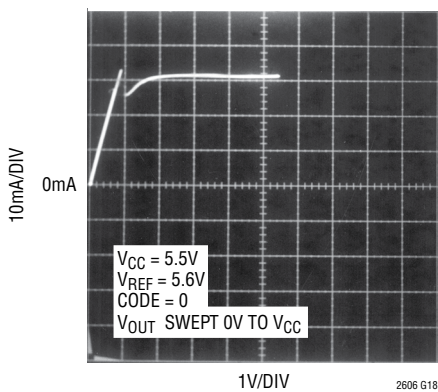

**Short-Circuit Output Current vs VOUT (Sourcing)**

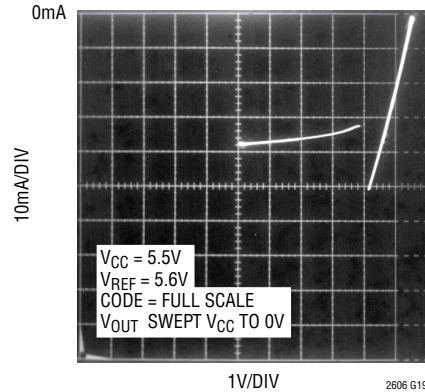

## PIN FUNCTIONS

**CA2 (Pin 1):** Chip Address Bit 2. Tie this pin to  $V_{CC}$ , GND or leave it floating to select an I<sup>2</sup>C slave address for the part (Table 1).

**SDA (Pin 2):** Serial Data Bidirectional Pin. Data is shifted into the SDA pin and acknowledged by the SDA pin. This pin is high impedance while data is shifted in. Open-drain N-channel output during acknowledgment. SDA requires a pull-up resistor or current source to  $V_{CC}$ .

**SCL (Pin 3):** Serial Clock Input Pin. Data is shifted into the SDA pin at the rising edges of the clock. This high impedance pin requires a pull-up resistor or current source to  $V_{CC}$ .

**CA0 (Pin 4):** Chip Address Bit 0. Tie this pin to  $V_{CC}$ , GND or leave it floating to select an I<sup>2</sup>C slave address for the part (Table 1).

**CA1 (Pin 5):** Chip Address Bit 1. Tie this pin to  $V_{CC}$ , GND or leave it floating to select an I<sup>2</sup>C slave address for the part (Table 1).

**REF (Pin 6):** Reference Voltage Input.  $0V \leq V_{REF} \leq V_{CC}$ .

**V<sub>OUT</sub> (Pin 7):** DAC Analog Voltage Output. The output range is 0V to  $V_{REF}$ .

**GND (Pin 8):** Analog Ground.

**V<sub>CC</sub> (Pin 9):** Supply Voltage Input.  $2.7V \leq V_{CC} \leq 5.5V$ .

**$\overline{LDAC}$  (Pin 10):** Asynchronous DAC Update. A falling edge on this input after four bytes have been written into the part immediately updates the DAC register with the contents of the input register. A low on this input without a complete 32-bit (four bytes including the slave address) data write transfer to the part does not update the DAC output. Software power-down is disabled when  $\overline{LDAC}$  is low.

**Exposed Pad (Pin 11):** Ground. Must be soldered to PCB ground.

## BLOCK DIAGRAM



## TEST CIRCUITS

Test Circuit 1

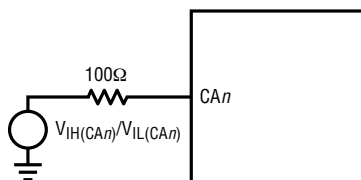

Test Circuit 2

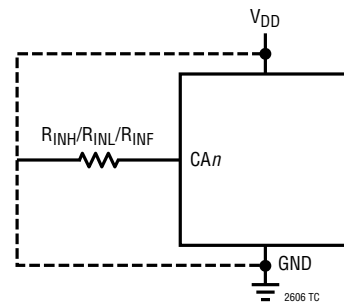

TIMING DIAGRAMS

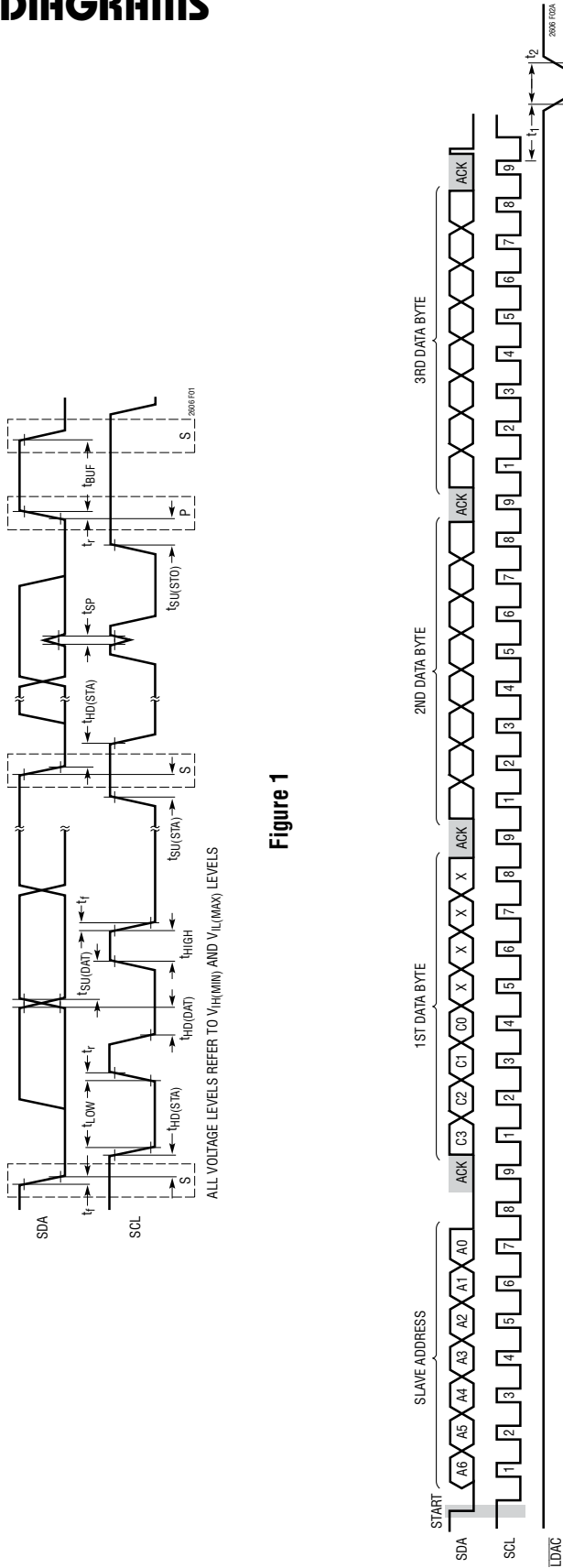

Figure 1

Figure 2a

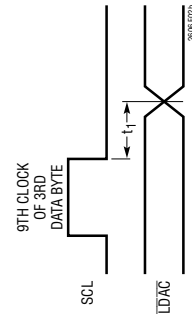

Figure 2b

## OPERATION

### Power-On Reset

The LTC2606/LTC2616/LTC2626 clear the outputs to zero-scale when power is first applied, making system initialization consistent and repeatable. The LTC2606-1/LTC2616-1/LTC2626-1 set the voltage outputs to mid-scale when power is first applied.

For some applications, downstream circuits are active during DAC power-up, and may be sensitive to nonzero outputs from the DAC during this time. The LTC2606/LTC2616/LTC2626 contain circuitry to reduce the power-on glitch; furthermore, the glitch amplitude can be made arbitrarily small by reducing the ramp rate of the power supply. For example, if the power supply is ramped to 5V in 1ms, the analog outputs rise less than 10mV above ground (typ) during power-on. See Power-On Reset Glitch in the Typical Performance Characteristics section.

### Power Supply Sequencing

The voltage at REF (Pin 6) should be kept within the range  $-0.3V \leq V_{REF} \leq V_{CC} + 0.3V$  (see Absolute Maximum Ratings). Particular care should be taken to observe these limits during power supply turn-on and turn-off sequences, when the voltage at  $V_{CC}$  (Pin 9) is in transition.

### Transfer Function

The digital-to-analog transfer function is:

$$V_{OUT(IDEAL)} = \left( \frac{k}{2^N} \right) V_{REF}$$

where  $k$  is the decimal equivalent of the binary DAC input code,  $N$  is the resolution and  $V_{REF}$  is the voltage at REF (Pin 6).

### Serial Digital Interface

The LTC2606/LTC2616/LTC2626 communicate with a host using the standard 2-wire I<sup>2</sup>C interface. The Timing Diagrams (Figures 1 and 2) show the timing relationship of the signals on the bus. The two bus lines, SDA and SCL, must be high when the bus is not in use. External

pull-up resistors or current sources are required on these lines. The value of these pull-up resistors is dependent on the power supply and can be obtained from the I<sup>2</sup>C specifications. For an I<sup>2</sup>C bus operating in the fast mode, an active pull-up will be necessary if the bus capacitance is greater than 200pF. The  $V_{CC}$  power should not be removed from the LTC2606/LTC2616/LTC2626 when the I<sup>2</sup>C bus is active to avoid loading the I<sup>2</sup>C bus lines through the internal ESD protection diodes.

The LTC2606/LTC2616/LTC2626 are receive-only (slave) devices. The master can write to the LTC2606/LTC2616/LTC2626. The LTC2606/LTC2616/LTC2626 do not respond to a read from the master.

### The START (S) and STOP (P) Conditions

When the bus is not in use, both SCL and SDA must be high. A bus master signals the beginning of a communication to a slave device by transmitting a START condition. A START condition is generated by transitioning SDA from high to low while SCL is high.

When the master has finished communicating with the slave, it issues a STOP condition. A STOP condition is generated by transitioning SDA from low to high while SCL is high. The bus is then free for communication with another I<sup>2</sup>C device.

### Acknowledge

The Acknowledge signal is used for handshaking between the master and the slave. An Acknowledge (active LOW) generated by the slave lets the master know that the latest byte of information was received. The Acknowledge related clock pulse is generated by the master. The master releases the SDA line (HIGH) during the Acknowledge clock pulse. The slave-receiver must pull down the SDA bus line during the Acknowledge clock pulse so that it remains a stable LOW during the HIGH period of this clock pulse. The LTC2606/LTC2616/LTC2626 respond to a write by a master in this manner. The LTC2606/LTC2616/LTC2626 do not acknowledge a read (retains SDA HIGH during the period of the Acknowledge clock pulse).

## OPERATION

### Chip Address

The state of CA0, CA1 and CA2 decides the slave address of the part. The pins CA0, CA1 and CA2 can be each set to any one of three states: V<sub>CC</sub>, GND or float. This results in 27 selectable addresses for the part. The slave address assignments are shown in Table 1.

**Table 1. Slave Address Map**

CA2	CA1	CA0	A6	A5	A4	A3	A2	A1	A0
GND	GND	GND	0	0	1	0	0	0	0
GND	GND	FLOAT	0	0	1	0	0	0	1
GND	GND	V <sub>CC</sub>	0	0	1	0	0	1	0
GND	FLOAT	GND	0	0	1	0	0	1	1
GND	FLOAT	FLOAT	0	1	0	0	0	0	0
GND	FLOAT	V <sub>CC</sub>	0	1	0	0	0	0	1
GND	V <sub>CC</sub>	GND	0	1	0	0	0	1	0
GND	V <sub>CC</sub>	FLOAT	0	1	0	0	0	1	1
GND	V <sub>CC</sub>	V <sub>CC</sub>	0	1	1	0	0	0	0
FLOAT	GND	GND	0	1	1	0	0	0	1
FLOAT	GND	FLOAT	0	1	1	0	0	1	0
FLOAT	GND	V <sub>CC</sub>	0	1	1	0	0	1	1
FLOAT	FLOAT	GND	1	0	0	0	0	0	0
FLOAT	FLOAT	FLOAT	1	0	0	0	0	0	1
FLOAT	FLOAT	V <sub>CC</sub>	1	0	0	0	0	1	0
FLOAT	V <sub>CC</sub>	GND	1	0	0	0	0	1	1
FLOAT	V <sub>CC</sub>	FLOAT	1	0	1	0	0	0	0
FLOAT	V <sub>CC</sub>	V <sub>CC</sub>	1	0	1	0	0	0	1
V <sub>CC</sub>	GND	GND	1	0	1	0	0	1	0
V <sub>CC</sub>	GND	FLOAT	1	0	1	0	0	1	1
V <sub>CC</sub>	GND	V <sub>CC</sub>	1	1	0	0	0	0	0
V <sub>CC</sub>	FLOAT	GND	1	1	0	0	0	0	1
V <sub>CC</sub>	FLOAT	FLOAT	1	1	0	0	0	1	0
V <sub>CC</sub>	FLOAT	V <sub>CC</sub>	1	1	0	0	0	1	1
V <sub>CC</sub>	V <sub>CC</sub>	GND	1	1	1	0	0	0	0
V <sub>CC</sub>	V <sub>CC</sub>	FLOAT	1	1	1	0	0	0	1
V <sub>CC</sub>	V <sub>CC</sub>	V <sub>CC</sub>	1	1	1	0	0	1	0
GLOBAL ADDRESS			1	1	1	0	0	1	1

In addition to the address selected by the address pins, the parts also respond to a global address. This address allows a common write to all LTC2606, LTC2616 and LTC2626 parts to be accomplished with one 3-byte write transaction on the I<sup>2</sup>C bus. The global address is a 7-bit on-chip hardwired address and is not selectable by CA0, CA1 and CA2.

The addresses corresponding to the states of CA0, CA1 and CA2 and the global address are shown in Table 1. The maximum capacitive load allowed on the address pins (CA0, CA1 and CA2) is 10pF, as these pins are driven during address detection to determine if they are floating.

### Write Word Protocol

The master initiates communication with the LTC2606/LTC2616/LTC2626 with a START condition and a 7-bit slave address followed by the Write bit (W) = 0. The LTC2606/LTC2616/LTC2626 acknowledges by pulling the SDA pin low at the 9th clock if the 7-bit slave address matches the address of the parts (set by CA0, CA1 and CA2) or the global address. The master then transmits three bytes of data. The LTC2606/LTC2616/LTC2626 acknowledges each byte of data by pulling the SDA line low at the 9th clock of each data byte transmission. After receiving three complete bytes of data, the LTC2606/LTC2616/LTC2626 executes the command specified in the 24-bit input word.

If more than three data bytes are transmitted after a valid 7-bit slave address, the LTC2606/LTC2616/LTC2626 do not acknowledge the extra bytes of data (SDA is high during the 9th clock).

The format of the three data bytes is shown in Figure 3. The first byte of the input word consists of the 4-bit command and four don't care bits. The next two bytes consist of the 16-bit data word. The 16-bit data word consists of the 16-, 14- or 12-bit input code, MSB to LSB, followed by 0, 2 or 4 don't care bits (LTC2606, LTC2616 and LTC2626 respectively). A typical LTC2606 write transaction is shown in Figure 4.

The command assignments (C3-C0) are shown in Table 2. The first four commands in the table consist of write and update operations. A write operation loads a 16-bit data word from the 32-bit shift register into the input register. In an update operation, the data word is copied from the input register to the DAC register and converted to an analog voltage at the DAC output. The update operation also powers up the DAC if it had been in power-down mode. The data path and registers are shown in the Block Diagram.

## OPERATION

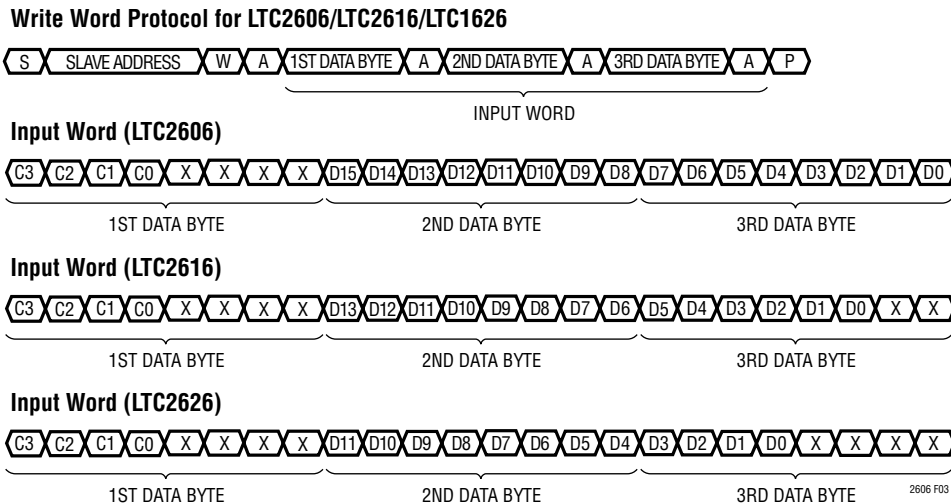

Figure 3

### Power-Down Mode

For power-constrained applications, power-down mode can be used to reduce the supply current whenever the DAC output is not needed. When in power-down, the buffer amplifier, bias circuit and reference input is disabled and draws essentially zero current. The DAC output is put into a high impedance state, and the output pin is passively pulled to ground through 90k resistors. Input- and DAC-register contents are not disturbed during power-down.

Table 2

COMMAND*				
C3	C2	C1	C0	
0	0	0	0	Write to Input Register
0	0	0	1	Update (Power Up) DAC Register
0	0	1	1	Write to and Update (Power Up)
0	1	0	0	Power Down
1	1	1	1	No Operation

\*Command codes not shown are reserved and should not be used.

The DAC channel can be put into power-down mode by using command 0100<sub>b</sub>. The 16-bit data word is ignored. The supply and reference currents are reduced to almost zero when the DAC is powered down; the effective resistance at REF becomes a high impedance input (typically >1GΩ).

Normal operation can be resumed by executing any command which includes a DAC update, as shown in Table 2 or

performing an asynchronous update ( $\overline{\text{LDAC}}$ ) as described in the next section. The DAC is powered up as its voltage output is updated. When the DAC in powered-down state is powered up and updated, normal settling is delayed. The main bias generation circuit block has been automatically shut down in addition to the DAC amplifier and reference input and so the power-up delay time is:

$$12\mu\text{s (for } V_{CC} = 5\text{V) or } 30\mu\text{s (for } V_{CC} = 3\text{V)}$$

### Asynchronous DAC Update Using LDAC

In addition to the update commands shown in Table 2, the  $\overline{\text{LDAC}}$  pin asynchronously updates the DAC register with the contents of the input register. Asynchronous update is disabled when the input word is being clocked into the part.

If a complete input word has been written to the part, a low on the  $\overline{\text{LDAC}}$  pin causes the DAC register to be updated with the contents of the input register.

If the input word is being written to the part, a low going pulse on the  $\overline{\text{LDAC}}$  pin before the completion of three bytes of data powers up the DAC but does not cause the output to be updated. If  $\overline{\text{LDAC}}$  remains low after a complete input word has been written to the part, then  $\overline{\text{LDAC}}$  is recognized, the command specified in the 24-bit word just transferred is executed and the DAC output is updated.

## OPERATION

The DAC is powered up when  $\overline{\text{LDAC}}$  is taken low, independent of any activity on the I<sup>2</sup>C bus.

If  $\overline{\text{LDAC}}$  is low at the falling edge of the 9th clock of the 3rd byte of data, it inhibits any software power-down command that was specified in the input word.

### Voltage Output

The rail-to-rail amplifier has guaranteed load regulation when sourcing or sinking up to 15mA at 5V (7.5mA at 3V).

Load regulation is a measure of the amplifier's ability to maintain the rated voltage accuracy over a wide range of load conditions. The measured change in output voltage per milliampere of forced load current change is expressed in LSB/mA.

DC output impedance is equivalent to load regulation, and may be derived from it by simply calculating a change in units from LSB/mA to Ohms. The amplifiers' DC output impedance is 0.050Ω when driving a load well away from the rails.

When drawing a load current from either rail, the output voltage headroom with respect to that rail is limited by the 25Ω typical channel resistance of the output devices; e.g., when sinking 1mA, the minimum output voltage = 25Ω • 1mA = 25mV. See the graph Headroom at Rails vs Output Current in the Typical Performance Characteristics section.

The amplifier is stable driving capacitive loads of up to 1000pF.

### Board Layout

The excellent load regulation performance is achieved in part by keeping "signal" and "power" grounds separated internally and by reducing shared internal resistance.

The GND pin functions both as the node to which the reference and output voltages are referred and as a return path for power currents in the device. Because of this, careful thought should be given to the grounding scheme and board layout in order to ensure rated performance.

The PC board should have separate areas for the analog and digital sections of the circuit. This keeps digital signals away from sensitive analog signals and facilitates the use of separate digital and analog ground planes which have minimal capacitive and resistive interaction with each other.

Digital and analog ground planes should be joined at only one point, establishing a system star ground as close to the device's ground pin as possible. Ideally, the analog ground plane should be located on the component side of the board, and should be allowed to run under the part to shield it from noise. Analog ground should be a continuous and uninterrupted plane, except for necessary lead pads and vias, with signal traces on another layer.

The GND pin of the part should be connected to analog ground. Resistance from the GND pin to system star ground should be as low as possible. Resistance here will add directly to the effective DC output impedance of the device (typically 0.050Ω). Note that the LTC2606/LTC2616/LTC2626 are no more susceptible to these effects than other parts of their type; on the contrary, they allow layout-based performance improvements to shine rather than limiting attainable performance with excessive internal resistance.

### Rail-to-Rail Output Considerations

In any rail-to-rail voltage output device, the output is limited to voltages within the supply range.

Since the analog output of the device cannot go below ground, it may limit for the lowest codes as shown in Figure 5b. Similarly, limiting can occur near full-scale when the REF pin is tied to V<sub>CC</sub>. If V<sub>REF</sub> = V<sub>CC</sub> and the DAC full-scale error (FSE) is positive, the output for the highest codes limits at V<sub>CC</sub> as shown in Figure 5c. No full-scale limiting can occur if V<sub>REF</sub> is less than V<sub>CC</sub> - FSE.

Offset and linearity are defined and tested over the region of the DAC transfer function where no output limiting can occur.

# OPERATION

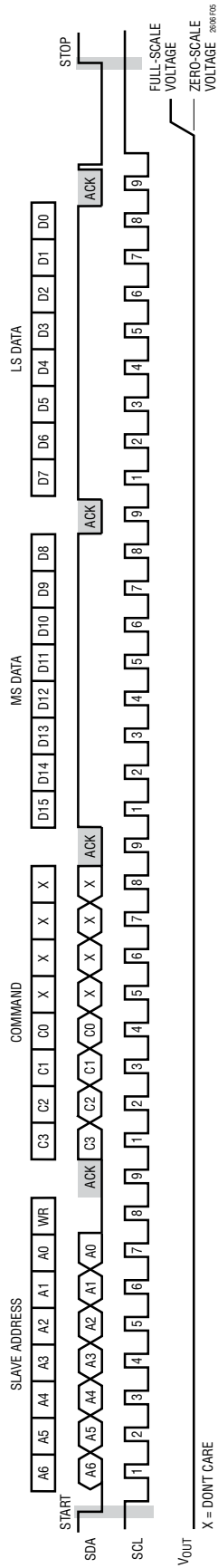

Figure 4. Typical LTC2606 Input Waveform—Programming DAC Output for Full Scale

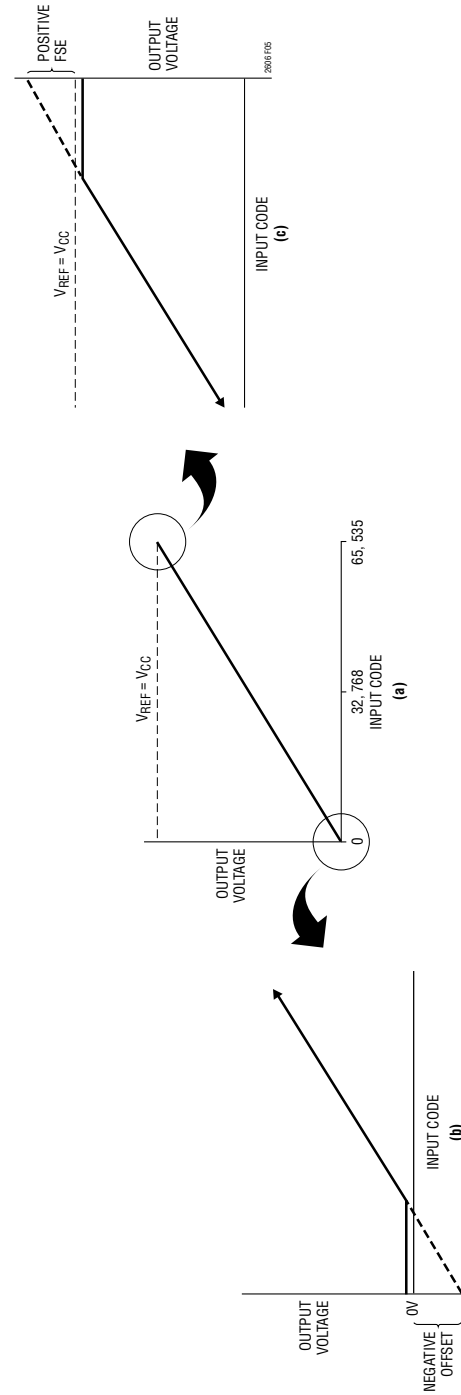
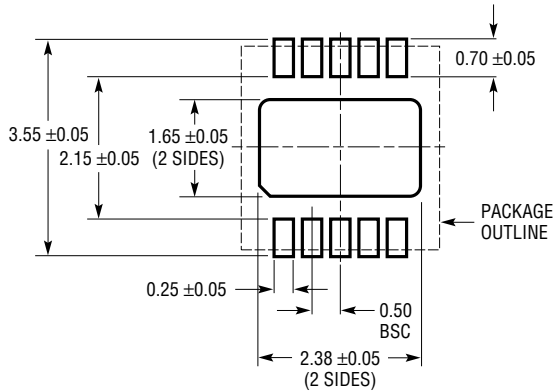

Figure 5. Effects of Rail-to-Rail Operation on a DAC Transfer Function. (a) Overall Transfer Function (b) Effect of Negative Offset for Codes Near Zero Scale (c) Effect of Positive Full-Scale Error for Codes Near Full Scale

## PACKAGE DESCRIPTION

Please refer to <http://www.linear.com/product/LTC2606#packaging> for the most recent package drawings.

### DD Package 10-Lead Plastic DFN (3mm × 3mm) (Reference LTC DWG # 05-08-1699 Rev C)



#### RECOMMENDED SOLDER PAD PITCH AND DIMENSIONS

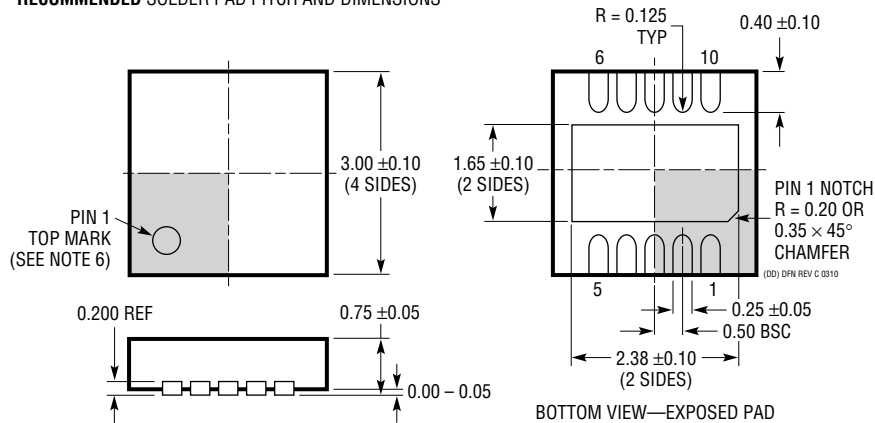

#### NOTE:

1. DRAWING TO BE MADE A JEDEC PACKAGE OUTLINE M0-229 VARIATION OF (WEED-2). CHECK THE LTC WEBSITE DATA SHEET FOR CURRENT STATUS OF VARIATION ASSIGNMENT
2. DRAWING NOT TO SCALE
3. ALL DIMENSIONS ARE IN MILLIMETERS
4. DIMENSIONS OF EXPOSED PAD ON BOTTOM OF PACKAGE DO NOT INCLUDE MOLD FLASH. MOLD FLASH, IF PRESENT, SHALL NOT EXCEED 0.15mm ON ANY SIDE
5. EXPOSED PAD SHALL BE SOLDER PLATED
6. SHADED AREA IS ONLY A REFERENCE FOR PIN 1 LOCATION ON THE TOP AND BOTTOM OF PACKAGE

**REVISION HISTORY** (Revision history begins at Rev B)

REV	DATE	DESCRIPTION	PAGE NUMBER
B	11/09	Insert Text in Serial Digital Interface Section	13
C	6/17	Corrected Order Information for LTC2616-1	2

## TYPICAL APPLICATION

Demo Circuit Schematic. Onboard 20-Bit ADC Measures Key Performance Parameters

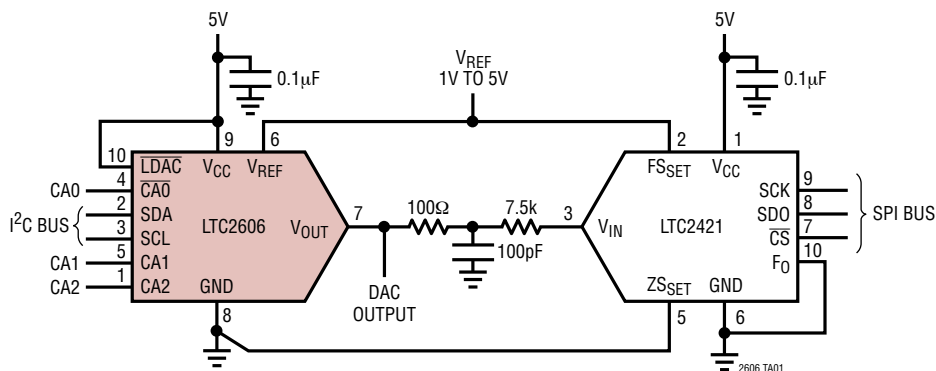

## RELATED PARTS

PART NUMBER	DESCRIPTION	COMMENTS
<a href="#">LTC1458/LTC1458L</a>	Quad 12-Bit Rail-to-Rail Output DACs with Added Functionality	LTC1458: $V_{CC} = 4.5V$ to $5.5V$ , $V_{OUT} = 0V$ to $4.096V$ LTC1458L: $V_{CC} = 2.7V$ to $5.5V$ , $V_{OUT} = 0V$ to $2.5V$
<a href="#">LTC1654</a>	Dual 14-Bit Rail-to-Rail $V_{OUT}$ DAC	Programmable Speed/Power, $3.5\mu s/750\mu A$ , $8\mu s/450\mu A$
<a href="#">LTC1655/LTC1655L</a>	Single 16-Bit $V_{OUT}$ DACs with Serial Interface in SO-8	$V_{CC} = 5V(3V)$ , Low Power, Deglitched
<a href="#">LTC1657/LTC1657L</a>	Parallel 5V/3V 16-Bit $V_{OUT}$ DACs	Low Power, Deglitched, Rail-to-Rail $V_{OUT}$
<a href="#">LTC1660/LTC1665</a>	Octal 10/8-Bit $V_{OUT}$ DACs in 16-Pin Narrow SSOP	$V_{CC} = 2.7V$ to $5.5V$ , Micropower, Rail-to-Rail Output
<a href="#">LTC1821</a>	Parallel 16-Bit Voltage Output DAC	Precision 16-Bit Settling in $2\mu s$ for 10V Step
<a href="#">LTC2600/LTC2610</a> <a href="#">LTC2620</a>	Octal 16-/14-/12-Bit $V_{OUT}$ DACs in 16-Lead SSOP	$250\mu A$ per DAC, $2.5V$ to $5.5V$ Supply Range, Rail-to-Rail Output, SPI Serial Interface
<a href="#">LTC2601/LTC2611</a> <a href="#">LTC2621</a>	Single 16-/14-/12-Bit $V_{OUT}$ DACs in 10-Lead DFN	$250\mu A$ per DAC, $2.5V$ to $5.5V$ Supply Range, Rail-to-Rail Output, SPI Serial Interface
<a href="#">LTC2602/LTC2612</a> <a href="#">LTC2622</a>	Dual 16-/14-/12-Bit $V_{OUT}$ DACs in 8-Lead MSOP	$300\mu A$ per DAC, $2.5V$ to $5.5V$ Supply Range, Rail-to-Rail Output, SPI Serial Interface
<a href="#">LTC2604/LTC2614</a> <a href="#">LTC2624</a>	Quad 16-/14-/12-Bit $V_{OUT}$ DACs in 16-Lead SSOP	$250\mu A$ per DAC, $2.5V$ to $5.5V$ Supply Range, Rail-to-Rail Output, SPI Serial Interface

## Looking for pricing, stock, or lifecycle information?

Click below to explore more details on WIN SOURCE:

 [View LTC2606IDD#PBF on WIN SOURCE](#)

 [Linear Technology](#) Information

## Optimize Your Supply Chain with WIN SOURCE Solutions

-  Global Sourcing Solution
-  Obsolete Management
-  Cost Control Management
-  Shortage Management
-  Alternative Solution
-  Excess Inventory Management