



**THE DATASHEET OF
LTC2050CS6#TRPBF**



Zero-Drift Operational Amplifiers in SOT-23

FEATURES

- **Maximum Offset Voltage of 3 μ V**
- **Maximum Offset Voltage Drift of 30nV/ $^{\circ}$ C**
- Noise: 1.5 μ V_{P-P} (0.01Hz to 10Hz Typ)
- Voltage Gain: 140dB (Typ)
- PSRR: 130dB (Typ)
- CMRR: 130dB (Typ)
- Supply Current: 0.8mA (Typ)
- Supply Operation
 - LTC2050: 2.7V to 6V
 - LTC2050HV: 2.7V to \pm 5.5V
 - LTC2050HVMP: 4.5V to \pm 5.5V
- Extended Common Mode Input Range
- Output Swings Rail-to-Rail
- Input Overload Recovery Time: 2ms (Typ)
- Operating Temperature Range
 - LTC2050: -40° C to 125° C
 - LTC2050HVMP: -55° C to 150° C
- Low Profile (1mm) SOT-23 (ThinSOT™) Package

APPLICATIONS

- Thermocouple Amplifiers
- Electronic Scales
- Medical Instrumentation
- Strain Gauge Amplifiers
- High Resolution Data Acquisition
- DC Accurate RC Active Filters
- Low Side Current Sense

DESCRIPTION

The **LTC[®]2050** and **LTC2050HV** are zero-drift operational amplifiers available in the 5- or 6-lead SOT-23 and SO-8 packages. The LTC2050 operates from a single 2.7V to 6V supply. The LTC2050HV operates on supplies from 2.7V to \pm 5.5V. The current consumption is 800 μ A and the versions in the 6-lead SOT-23 and SO-8 packages offer power shutdown (active low). The LTC2050HVMP offer operating range from 4.5V to \pm 5.5V and operating temperature range of -55° C to 150° C.

The LTC2050, despite its miniature size, features uncompromising DC performance. The typical input offset voltage and offset drift are 0.5 μ V and 10nV/ $^{\circ}$ C. The almost zero DC offset and drift are supported with a power supply rejection ratio (PSRR) and common mode rejection ratio (CMRR) of more than 130dB.

The input common mode voltage ranges from the negative supply up to typically 1V from the positive supply. The LTC2050 also has an enhanced output stage capable of driving loads as low as 2k Ω to both supply rails. The open-loop gain is typically 140dB. The LTC2050 also features a 1.5 μ V_{P-P} DC to 10Hz noise and a 3MHz gain bandwidth product.

All registered trademarks and trademarks are the property of their respective owners. Protected by U.S. patents, including 5481178.

TYPICAL APPLICATION

Differential Bridge Amplifier



Input Referred Noise 0.1Hz to 10Hz



LTC2050/LTC2050HV

ABSOLUTE MAXIMUM RATINGS

(Note 1)

Total Supply Voltage (V^+ to V^-)

LTC2050 7V

LTC2050HV 12V

Input Voltage ($V^+ + 0.3V$) to ($V^- - 0.3V$)

Output Short-Circuit Duration Indefinite

Operating Temperature Range

LTC2050 -40°C to 125°C

LTC2050HVMP -55°C to 150°C

Specified Temperature Range

(Note 3) -55°C to 150°C

Storage Temperature Range -65°C to 150°C

Lead Temperature (Soldering, 10 sec) 300°C

PIN CONFIGURATION



ORDER INFORMATION

LEAD FREE FINISH	TAPE AND REEL	PART MARKING*	PACKAGE DESCRIPTION	SPECIFIED TEMPERATURE RANGE
LTC2050CS5#PBF	LTC2050CS5#TRPBF	LTAEG	5-Lead Plastic TSOT-23	0°C to 70°C
LTC2050IS5#PBF	LTC2050IS5#TRPBF	LTAEG	5-Lead Plastic TSOT-23	-40°C to 85°C
LTC2050HS5#PBF	LTC2050HS5#TRPBF	LTAEG	5-Lead Plastic TSOT-23	-40°C to 125°C
LTC2050HVCS5#PBF	LTC2050HVCS5#TRPBF	LTAEH	5-Lead Plastic TSOT-23	0°C to 70°C
LTC2050HVIS5#PBF	LTC2050HVIS5#TRPBF	LTAEH	5-Lead Plastic TSOT-23	-40°C to 85°C
LTC2050HVHS5#PBF	LTC2050HVHS5#TRPBF	LTAEH	5-Lead Plastic TSOT-23	-40°C to 125°C
LTC2050CS6#PBF	LTC2050CS6#TRPBF	LTA EJ	6-Lead Plastic TSOT-23	0°C to 70°C
LTC2050IS6#PBF	LTC2050IS6#TRPBF	LTA EJ	6-Lead Plastic TSOT-23	-40°C to 85°C
LTC2050HS6#PBF	LTC2050HS6#TRPBF	LTA EJ	6-Lead Plastic TSOT-23	-40°C to 125°C
LTC2050HVMP6#PBF	LTC2050HVMP6#TRPBF	LTHGP	6-Lead Plastic TSOT-23	-55°C to 150°C
LTC2050HVCS6#PBF	LTC2050HVCS6#TRPBF	LTA EK	6-Lead Plastic TSOT-23	0°C to 70°C
LTC2050HVIS6#PBF	LTC2050HVIS6#TRPBF	LTA EK	6-Lead Plastic TSOT-23	-40°C to 85°C
LTC2050HVHS6#PBF	LTC2050HVHS6#TRPBF	LTA EK	6-Lead Plastic TSOT-23	-40°C to 125°C
LTC2050CS8#PBF	LTC2050CS8#TRPBF	2050	8-Lead Plastic SO	0°C to 70°C
LTC2050IS8#PBF	LTC2050IS8#TRPBF	2050I	8-Lead Plastic SO	-40°C to 85°C
LTC2050HVCS8#PBF	LTC2050HVCS8#TRPBF	2050HV	8-Lead Plastic SO	0°C to 70°C

Rev. E

ORDER INFORMATION

LEAD FREE FINISH	TAPE AND REEL	PART MARKING*	PACKAGE DESCRIPTION	SPECIFIED TEMPERATURE RANGE
LTC2050HVIS8#PBF	LTC2050HVIS8#TRPBF	050HVI	8-Lead Plastic SO	-40°C to 85°C
LTC2050CS5	LTC2050CS5#TR	LTAEG	5-Lead Plastic TSOT-23	0°C to 70°C
LTC2050IS5	LTC2050IS5#TR	LTAEG	5-Lead Plastic TSOT-23	-40°C to 85°C
LTC2050HS5	LTC2050HS5#TR	LTAEG	5-Lead Plastic TSOT-23	-40°C to 125°C
LTC2050HVCS5	LTC2050HVCS5#TR	LTAEH	5-Lead Plastic TSOT-23	0°C to 70°C
LTC2050HVIS5	LTC2050HVIS5#TR	LTAEH	5-Lead Plastic TSOT-23	-40°C to 85°C
LTC2050HVHS5	LTC2050HVHS5#TR	LTAEH	5-Lead Plastic TSOT-23	-40°C to 125°C
LTC2050CS6	LTC2050CS6#TR	LTA EJ	6-Lead Plastic TSOT-23	0°C to 70°C
LTC2050IS6	LTC2050IS6#TR	LTA EJ	6-Lead Plastic TSOT-23	-40°C to 85°C
LTC2050HS6	LTC2050HS6#TR	LTA EJ	6-Lead Plastic TSOT-23	-40°C to 125°C
LTC2050HVCS6	LTC2050HVCS6#TR	LTA EK	6-Lead Plastic TSOT-23	0°C to 70°C
LTC2050HVIS6	LTC2050HVIS6#TR	LTA EK	6-Lead Plastic TSOT-23	-40°C to 85°C
LTC2050HVHS6	LTC2050HVHS6#TR	LTA EK	6-Lead Plastic TSOT-23	-40°C to 125°C
LTC2050CS8	LTC2050CS8#TR	2050	8-Lead Plastic SO	0°C to 70°C
LTC2050IS8	LTC2050IS8#TR	2050I	8-Lead Plastic SO	-40°C to 85°C
LTC2050HVCS8	LTC2050HVCS8#TR	2050HV	8-Lead Plastic SO	0°C to 70°C
LTC2050HVIS8	LTC2050HVIS8#TR	050HVI	8-Lead Plastic SO	-40°C to 85°C

Contact the factory for parts specified with wider operating temperature ranges. *The temperature grade is identified by a label on the shipping container.
[Tape and reel specifications](#). Some packages are available in 500 unit reels through designated sales channels with #TRMPBF suffix.

LTC2050/LTC2050HV

ELECTRICAL CHARACTERISTICS (LTC2050/LTC2050HV) The ● denotes the specifications which apply over the full operating temperature range, otherwise specifications are at $T_A = 25^\circ\text{C}$. $V_S = 3\text{V}$ unless otherwise noted. (Note 3)

PARAMETER	CONDITIONS	C, I SUFFIXES			H SUFFIX			UNITS
		MIN	TYP	MAX	MIN	TYP	MAX	
Input Offset Voltage	(Note 2)		±0.5	±3		±0.5	±3	μV
Average Input Offset Drift	(Note 2)	●		±0.03			±0.05	μV/°C
Long-Term Offset Drift			50			50		nV/√mō
Input Bias Current	LTC2050	●	±20	±75 ±300		±20	±75 ±4000	pA pA
	LTC2050HV	●	±1	±50 ±100		±1	±50 ±4000	pA pA
Input Offset Current	LTC2050	●		±150 ±200			±150 ±1000	pA pA
	LTC2050HV	●		±100 ±150			±100 ±1000	pA pA
Input Noise Voltage	$R_S = 100\Omega$, 0.01Hz to 10Hz		1.5			1.5		μV _{P-P}
Input Capacitance			1.7			1.7		pF
Common Mode Rejection Ratio	LTC2050/LTC2050HV $V_{CM} = \text{GND to } (V^+ - 1.3)$ $V_{CM} = \text{GND to } (V^+ - 1.3)$	●	115	130		115	130	dB
			110	130		110	130	dB
Power Supply Rejection Ratio	$V_S = 2.7\text{V to } 6\text{V}$	●	120	130		120	130	dB
			115	130		115	130	dB
Large-Signal Voltage Gain	$R_L = 10\text{k}$	●	120	140		120	140	dB
			115	140		115	140	dB
Output Voltage Swing High	$R_L = 2\text{k to GND}$	●	2.85	2.94		2.85	2.94	V
	$R_L = 10\text{k to GND}$	●	2.95	2.98		2.95	2.98	V
Output Voltage Swing Low	$R_L = 2\text{k to GND}$	●	1	10		1	10	mV
	$R_L = 10\text{k to GND}$	●	1	10		1	10	mV
Slew Rate			2			2		V/μs
Gain Bandwidth Product			3			3		MHz
Supply Current	$V_{SHDN} = V_{IH}$, No Load $V_{SHDN} = V_{IL}$	●	0.75	1.1		0.75	1.2	mA
		●		10			10	μA
Shutdown Pin Input Low Voltage (V_{IL})		●		$V^- + 0.5$			$V^- + 0.5$	V
Shutdown Pin Input High Voltage (V_{IH})		●	$V^+ - 0.5$			$V^+ - 0.5$		V
Shutdown Pin Input Current	$V_{SHDN} = \text{GND}$	●	-0.5	-3		-0.5	-3	μA
Internal Sampling Frequency			7.5			7.5		kHz

ELECTRICAL CHARACTERISTICS

The ● denotes the specifications which apply over the full operating temperature range, otherwise specifications are at $T_A = 25^\circ\text{C}$. (LTC2050/LTC2050HV) $V_S = 5\text{V}$ unless otherwise noted. (Note 3)

PARAMETER	CONDITIONS	C, I SUFFIXES			H, MP SUFFIX			UNITS
		MIN	TYP	MAX	MIN	TYP	MAX	
Input Offset Voltage	(Note 2)		±0.5	±3		±0.5	±3	μV
Average Input Offset Drift	(Note 2) LTC2050HVMP	●		±0.03			±0.05 ±0.10	μV/°C μV/°C
Long-Term Offset Drift			50			50		nV/√mo
Input Bias Current	LTC2050	●	±75	±150 ±300		±75	±150 ±4000	pA pA
	LTC2050HV	●	±7	±50 ±150		±7	±50 ±4000	pA pA
	LTC2050HVMP	●				±7	±50 ±8000	pA pA
Input Offset Current	LTC2050	●		±300 ±400			±300 ±1000	pA pA
	LTC2050HV	●		±100 ±200			±100 ±1000	pA pA
	LTC2050HVMP	●					±2000	pA
Input Noise Voltage	$R_S = 100\Omega$, 0.01Hz to 10Hz		1.5			1.5		μV _{r-p}
Common Mode Rejection Ratio	LTC2050/LTC2050HV $V_{CM} = \text{GND to } (V^+ - 1.3)$ $V_{CM} = \text{GND to } (V^+ - 1.3)$	●	120 115	130 130		120 110	130 130	dB dB
	LTC2050HVMP $V_{CM} = \text{GND to } (V^+ - 1.3)$	●				107	130	dB
Power Supply Rejection Ratio	$V_S = 2.7\text{V to } 6\text{V}$	●	120 115	130 130		120 115	130 130	dB dB
	LTC2050HVMP $V_S = 4.5\text{V to } 11\text{V}$	●				117 112	130 130	dB dB
Large-Signal Voltage Gain	$R_L = 10\text{k}$	●	125 120	140 140		125 115	140 140	dB dB
Output Voltage Swing High	$R_L = 2\text{k to GND}$	●	4.85	4.94		4.85	4.94	V
	$R_L = 10\text{k to GND}$	●	4.95	4.98		4.95	4.98	V
Output Voltage Swing Low	$R_L = 2\text{k to GND}$	●		1 10		1 10	10 10	mV mV
	$R_L = 10\text{k to GND}$	●		1 10		1 10	10 10	mV mV
Slew Rate			2			2		V/μs
Gain Bandwidth Product			3			3		MHz
Supply Current	$V_{SHDN} = V_{IH}$, No Load	●		0.8 1.2		0.8	1.3	mA μA
	$V_{SHDN} = V_{IL}$	●		15			15	
Shutdown Pin Input Low Voltage (V_{IL})		●		$V^- + 0.5$			$V^- + 0.5$	V
Shutdown Pin Input High Voltage (V_{IH})		●	$V^+ - 0.5$			$V^+ - 0.5$		V
Shutdown Pin Input Current	$V_{SHDN} = \text{GND}$	●	-0.5	-7		-0.5	-7	μA
Internal Sampling Frequency			7.5			7.5		kHz

LTC2050/LTC2050HV

ELECTRICAL CHARACTERISTICS (LTC2050HV) The ● denotes the specifications which apply over the full operating temperature range, otherwise specifications are at $T_A = 25^\circ\text{C}$. $V_S = \pm 5\text{V}$ unless otherwise noted. (Note 3)

PARAMETER	CONDITIONS	C, I SUFFIXES			H, MP SUFFIX			UNITS	
		MIN	TYP	MAX	MIN	TYP	MAX		
Input Offset Voltage	(Note 2)		±0.5	±3		±0.5	±3	μV	
Average Input Offset Drift	(Note 2) LTC2050HVMP	●		±0.03			±0.05 ±0.10	μV/°C μV/°C	
Long-Term Offset Drift			50			50		nV/√mo	
Input Bias Current (Note 4)	LTC2050HV	●	±25	±125 ±300		±25	±125 ±4000	ρA ρA	
	LTC2050HVMP	●				±25	±125 ±8000	ρA ρA	
Input Offset Current (Note 4)	LTC2050HV	●		±250 ±500			±250 ±1000	ρA ρA	
	LTC2050HVMP	●					±2000	ρA	
Input Noise Voltage	$R_S = 100\Omega$, 0.01Hz to 10Hz		1.5			1.5		μV _{p-p}	
Common Mode Rejection Ratio	LTC2050HV $V_{CM} = V^-$ to $(V^+ - 1.3)$ $V_{CM} = V^-$ to $(V^+ - 1.3)$	●	120 115	130 130		120 115	130 130	dB dB	
	LTC2050HVMP $V_{CM} = V^-$ to $(V^+ - 1.3)$	●				112	130	dB	
Power Supply Rejection Ratio	$V_S = 2.7\text{V}$ to 11V	●	120 115	130 130		120 115	130 130	dB dB	
	LTC2050HVMP $V_S = 4.5$ to 11V	●				117 112	130 130	dB dB	
Large-Signal Voltage Gain	$R_L = 10\text{k}$	●	125 120	140 140		125 120	140 140	dB dB	
Maximum Output Voltage Swing	$R_L = 2\text{k}$ to GND	●	±4.75	±4.94		±4.50	±4.94	V	
	$R_L = 10\text{k}$ to GND	●	±4.90	±4.98		±4.85	±4.98	V	
Slew Rate			2			2		V/μs	
Gain Bandwidth Product			3			3		MHz	
Supply Current	$V_{SHDN} = V_{IH}$, No Load	●		1	1.5		1	1.6	mA
	$V_{SHDN} = V_{IL}$	●			25			25	μA
Shutdown Pin Input Low Voltage (V_{IL})		●			$V^- + 0.5$		$V^- + 0.5$	V	
Shutdown Pin Input High Voltage (V_{IH})		●	$V^+ - 0.5$			$V^+ - 0.5$		V	
Shutdown Pin Input Current	$V_{SHDN} = V^-$	●		-3	-20		-3	-20	μA
Internal Sampling Frequency			7.5			7.5		kHz	

Note 1: Stresses beyond those listed under Absolute Maximum Ratings may cause permanent damage to the device. Exposure to any Absolute Maximum Rating condition for extended periods may affect device reliability and lifetime.

Note 2: These parameters are guaranteed by design. Thermocouple effects preclude measurements of these voltage levels during automated testing.

Note 3: All versions of the LTC2050 are designed, characterized and expected to meet the extended temperature limits of -40°C and 125°C .

The LTC2050C/LTC2050HVC are guaranteed to meet the temperature limits of 0°C and 70°C . The LTC2050I/LTC2050HVI are guaranteed to meet the temperature limits of -40°C and 85°C . The LTC2050H/LTC2050HVH are guaranteed to meet the temperature limits of -40°C and 125°C . The are guaranteed to meet the temperature limits of -55°C and 150°C .

Note 4: The bias current measurement accuracy depends on the proximity of the supply bypass capacitor to the device under test, especially at $\pm 5\text{V}$ supplies. Because of testing limitations on the placement of this bypass capacitor, the bias current at $\pm 5\text{V}$ supplies is guaranteed by design to meet the data sheet limits, but tested to relaxed limits.

TYPICAL PERFORMANCE CHARACTERISTICS

Common Mode Rejection Ratio vs Frequency

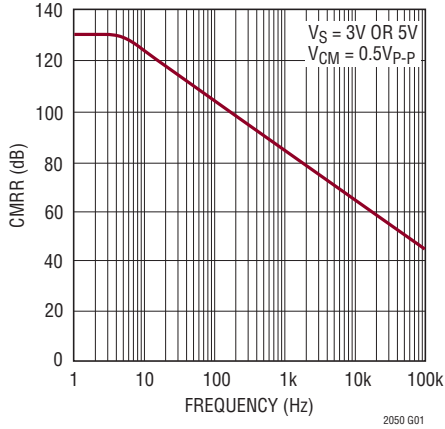

DC CMRR vs Common Mode Input Voltage

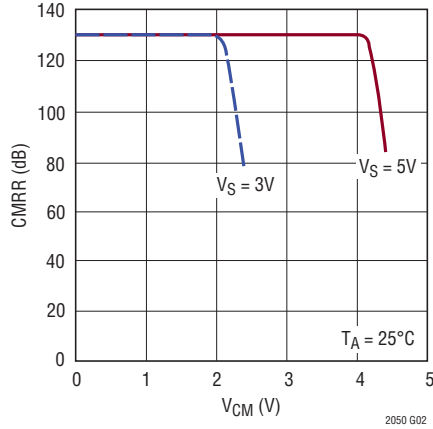

PSRR vs Frequency

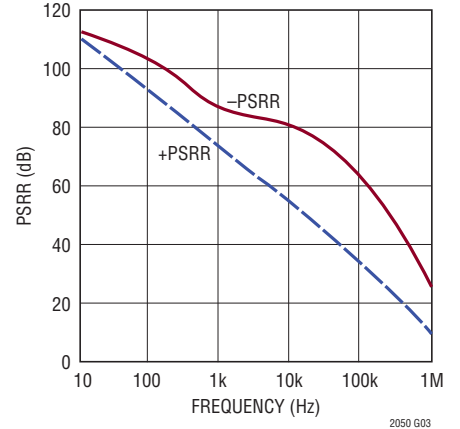

Output Voltage Swing vs Load Resistance



Output Swing vs Output Current



Output Swing vs Load Resistance ±5V Supply



Output Swing vs Output Current ±5V Supply



Gain/Phase vs Frequency



Input Bias Current vs Temperature (LTC2050)



TYPICAL PERFORMANCE CHARACTERISTICS

Input Bias Current vs Temperature (LTC2050HVMP)

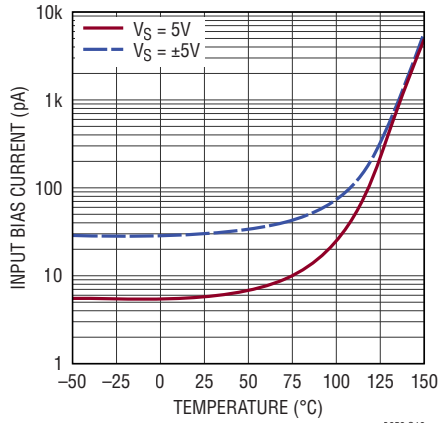

2050 G10

Input Bias Current vs Temperature (LTC2050HV)

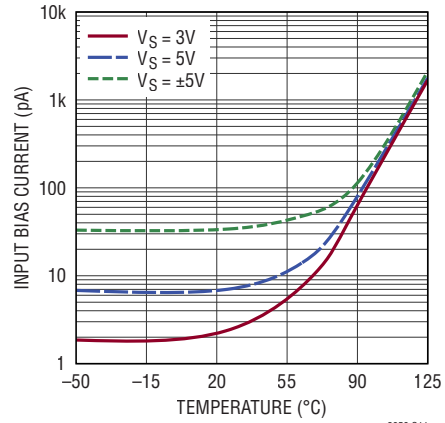

2050 G11

Input Bias Current vs Input Common Mode Voltage

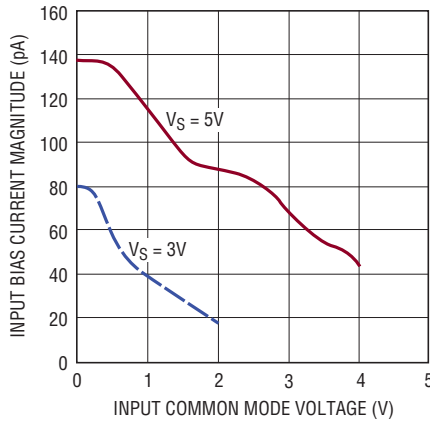

2050 G12

Input Bias Current vs Input Common Mode Voltage (LTC2050HV)

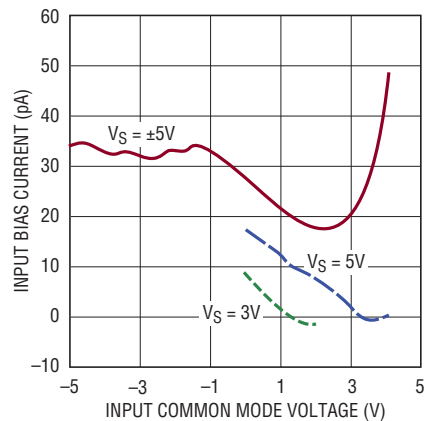

2050 G13

Transient Response

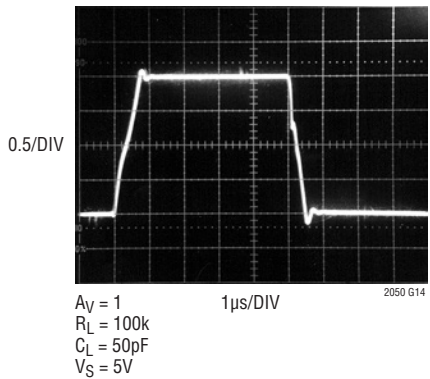

2050 G14

Input Overload Recovery

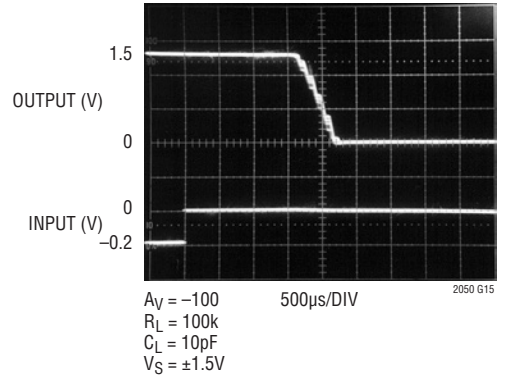

2050 G15

TYPICAL PERFORMANCE CHARACTERISTICS

Sampling Frequency vs Supply Voltage



Sampling Frequency vs Temperature

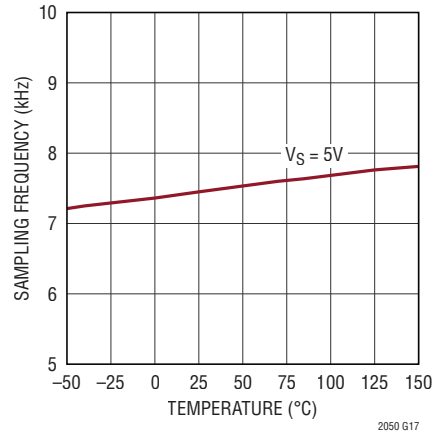

Supply Current vs Supply Voltage



Supply Current vs Temperature

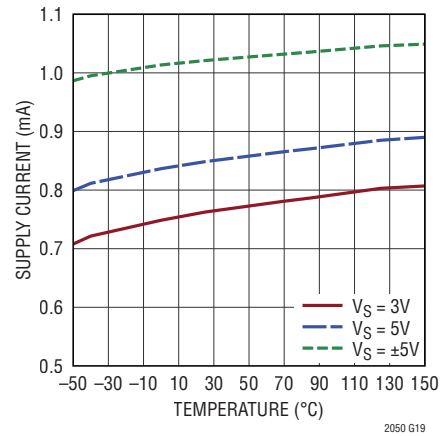

TEST CIRCUITS

Electrical Characteristics Test Circuit

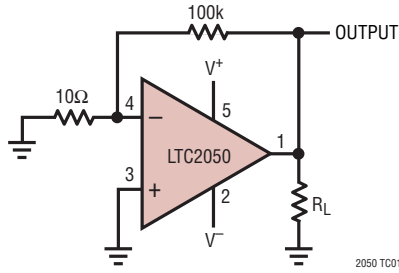

DC-10Hz Noise Test Circuit



APPLICATIONS INFORMATION

Shutdown

The LTC2050 includes a shutdown pin in the 6-lead SOT-23 and the SO-8 version. When this active low pin is high or allowed to float, the device operates normally. When the shutdown pin is pulled low, the device enters shutdown mode; supply current drops to 3 μ A, all clocking stops, and both inputs and output assume a high impedance state.

Clock Feedthrough, Input Bias Current

The LTC2050 uses auto-zeroing circuitry to achieve an almost zero DC offset over temperature, common mode voltage, and power supply voltage. The frequency of the clock used for auto-zeroing is typically 7.5kHz. The term clock feedthrough is broadly used to indicate visibility of this clock frequency in the op amp output spectrum. There are typically two types of clock feedthrough in auto zeroed op amps like the LTC2050.

The first form of clock feedthrough is caused by the settling of the internal sampling capacitor and is input referred; that is, it is multiplied by the closed loop gain of the op amp. This form of clock feedthrough is independent of the magnitude of the input source resistance or the magnitude of the gain setting resistors. The LTC2050 has a residue clock feedthrough of less than 1 μ V_{RMS} input referred at 7.5kHz.

The second form of clock feedthrough is caused by the small amount of charge injection occurring during the sampling and holding of the op amp's input offset voltage. The current spikes are multiplied by the impedance seen at the input terminals of the op amp, appearing at the

output multiplied by the closed loop gain of the op amp. To reduce this form of clock feedthrough, use smaller valued gain setting resistors and minimize the source resistance at the input. If the resistance seen at the inputs is less than 10k, this form of clock feedthrough is less than 1 μ V_{RMS} input referred at 7.5kHz, or less than the amount of residue clock feedthrough from the first form described above.

Placing a capacitor across the feedback resistor reduces either form of clock feedthrough by limiting the bandwidth of the closed loop gain.

Input bias current is defined as the DC current into the input pins of the op amp. The same current spikes that cause the second form of clock feedthrough described above, when averaged, dominate the DC input bias current of the op amp below 70°C.

At temperatures above 70°C, the leakage of the ESD protection diodes on the inputs increases the input bias currents of both inputs in the positive direction, while the current caused by the charge injection stays relatively constant. At elevated temperatures (above 85°C) the leakage current begins to dominate and both the negative and positive pin's input bias currents are in the positive direction (into the pins).

Input Pins, ESD Sensitivity

ESD voltages above 700V on the input pins of the op amp will cause the input bias currents to increase (more DC current into the pins). At these voltages, it is possible to damage the device to a point where the input bias current exceeds the maximums specified in this data sheet.

TYPICAL APPLICATIONS

Single Supply Thermocouple Amplifier



Gain of 1001 Single Supply Instrumentation Amplifier

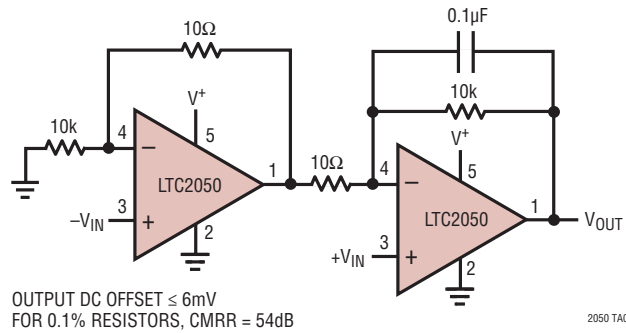

Instrumentation Amplifier with 100V Common Mode Input Voltage



PACKAGE DESCRIPTION

S5 Package
5-Lead Plastic TSOT-23
 (Reference LTC DWG # 05-08-1635 Rev B)



- NOTE:
1. DIMENSIONS ARE IN MILLIMETERS
 2. DRAWING NOT TO SCALE
 3. DIMENSIONS ARE INCLUSIVE OF PLATING
 4. DIMENSIONS ARE EXCLUSIVE OF MOLD FLASH AND METAL BURR
 5. MOLD FLASH SHALL NOT EXCEED 0.254mm
 6. JEDEC PACKAGE REFERENCE IS MO-193

S5 TSOT-23 0302 REV B

PACKAGE DESCRIPTION

S6 Package
6-Lead Plastic TSOT-23
 (Reference LTC DWG # 05-08-1636)

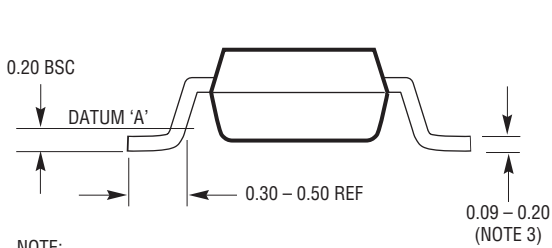
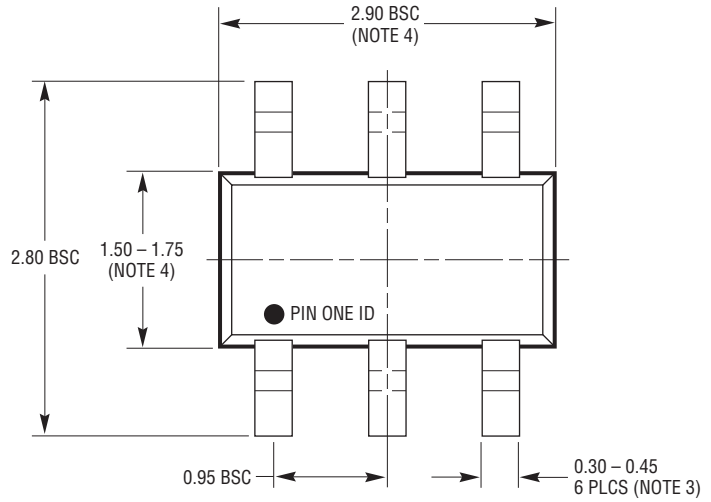
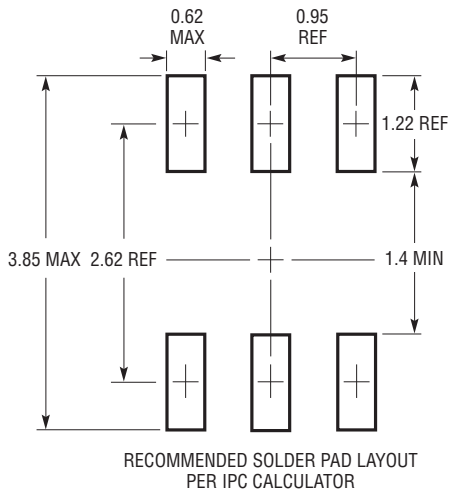

- NOTE:
1. DIMENSIONS ARE IN MILLIMETERS
 2. DRAWING NOT TO SCALE
 3. DIMENSIONS ARE INCLUSIVE OF PLATING
 4. DIMENSIONS ARE EXCLUSIVE OF MOLD FLASH AND METAL BURR
 5. MOLD FLASH SHALL NOT EXCEED 0.254mm
 6. JEDEC PACKAGE REFERENCE IS MO-193

S6 TSOT-23 0302

PACKAGE DESCRIPTION

S8 Package 8-Lead Plastic Small Outline (Narrow .150 Inch)

(Reference LTC DWG # 05-08-1610 Rev G)



REVISION HISTORY (Revision history begins at Rev D)

REV	DATE	DESCRIPTION	PAGE NUMBER
D	08/17	Updated T_{JMAX}	2
E	11/18	Added MP option (higher temperature version)	1, 2, 4-6, 7-8

TYPICAL APPLICATION

Ground Referred Precision Current Sources

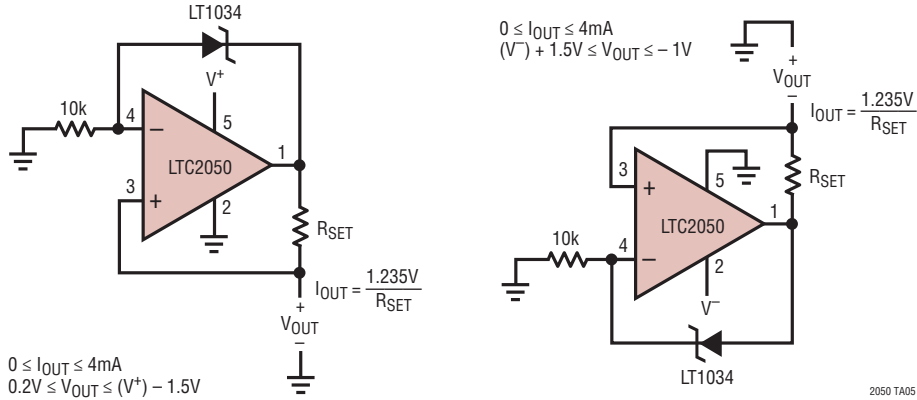

RELATED PARTS

PART NUMBER	DESCRIPTION	COMMENTS
LTC1049	Low Power Zero-Drift Op Amp	Low Supply Current 200µA
LTC1050	Precision Zero-Drift Op Amp	Single Supply Operation 4.75V to 16V, Noise Tested and Guaranteed
LTC1051/LTC1053	Precision Zero-Drift Op Amp	Dual/Quad
LTC1150	±15V Zero-Drift Op Amp	High Voltage Operation ±18V
LTC1152	Rail-to-Rail Input and Output Zero-Drift Op Amp	Single Zero-Drift Op Amp with Rail-to-Rail Input and Output and Shutdown
LT[®]1677	Low Noise Rail-to-Rail Input and Output Precision Op Amp	$V_{OS} = 90\mu\text{V}$, $V_S = 2.7\text{V to } 44\text{V}$
LT1884/LT1885	Rail-to-Rail Output Precision Op Amp	$V_{OS} = 50\mu\text{V}$, $I_B = 400\text{pA}$, $V_S = 2.7\text{V to } 40\text{V}$
LTC2051	Dual Zero-Drift Op Amp	Dual Version of the LTC2050 in MS8 Package

Looking for pricing, stock, or lifecycle information?

Click below to explore more details on WIN SOURCE:

 [View LTC2050CS6#TRPBF on WIN SOURCE](#)

 [Linear Technology](#) Information

Optimize Your Supply Chain with WIN SOURCE Solutions

-  Global Sourcing Solution
-  Obsolete Management
-  Cost Control Management
-  Shortage Management
-  Alternative Solution
-  Excess Inventory Management