

LTC1841/LTC1842/LTC1843

ABSOLUTE MAXIMUM RATINGS

(Note 1)

Voltage

V ⁺ to V ⁻	12V to -0.3V
IN ⁺ , IN ⁻ , HYST	(V ⁺ + 0.3V) to (V ⁻ - 0.3V)
REF	(V ⁺ + 0.3V) to (V ⁻ - 0.3V)
OUT	12V to (V ⁻ - 0.3V)

Current

IN ⁺ , IN ⁻ , HYST	20mA
REF	20mA
OUT	50mA

OUT Short-Circuit Duration (V⁺ ≤ 5.5V) Continuous
Power Dissipation 500mW

Operating Temperature Range

LTC1841C/LTC1842C/LTC1843C	0°C to 70°C
LTC1841I/LTC1842I/LTC1843I	-40°C to 85°C

Storage Temperature Range -65°C to 150°C

Lead Temperature (Soldering, 10 sec) 300°C

PACKAGE/ORDER INFORMATION

TOP VIEW		TOP VIEW		TOP VIEW	
OUT A 1	8 OUT B	OUT A 1	8 OUT B	OUT A 1	8 OUT B
V ⁻ 2	7 V ⁺	V ⁻ 2	7 V ⁺	V ⁻ 2	7 V ⁺
IN A ⁺ 3	6 IN B ⁺	IN A ⁺ 3	6 REF	IN A ⁺ 3	6 REF
IN A ⁻ 4	5 IN B ⁻	IN B ⁺ 4	5 HYST	IN B ⁻ 4	5 HYST
S8 PACKAGE 8-LEAD PLASTIC SO T _{JMAX} = 150°C, θ _{JA} = 125°C/W		S8 PACKAGE 8-LEAD PLASTIC SO T _{JMAX} = 150°C, θ _{JA} = 125°C/W		S8 PACKAGE 8-LEAD PLASTIC SO T _{JMAX} = 150°C, θ _{JA} = 125°C/W	
ORDER PART NUMBER	S8 PART MARKING	ORDER PART NUMBER	S8 PART MARKING	ORDER PART NUMBER	S8 PART MARKING
LTC1841CS8 LTC1841IS8	1841 1841I	LTC1842CS8 LTC1842IS8	1842 1842I	LTC1843CS8 LTC1843IS8	1843 1843I

Consult factory for Military grade parts.

ELECTRICAL CHARACTERISTICS V⁺ = 5V, V⁻ = 0V, T_A = 25°C unless otherwise noted.

SYMBOL	PARAMETER	CONDITIONS	MIN	TYP	MAX	UNITS
Power Supply						
V ⁺	Supply Voltage Range	LTC1841	● 2.0		11	V
		LTC1842/LTC1843	● 2.5		11	V
I _{CC}	Supply Current	HYST = REF (Note 2)	●	3.5	5.7	μA
Comparator						
V _{OS}	Comparator Input Offset Voltage	(Note 3)	●	±3	±10	mV
I _{IN}	Input Leakage Current (IN ⁺ , IN ⁻)	IN ⁺ = IN ⁻ = 2.5V (LTC1841), IN ⁺ = IN ⁻ = V _{REF} (LTC1842/LTC1843)	●	±0.01	±1.0	nA
V _{IN}	Comparator Input Voltage Range		●	V ⁻	V ⁺ - 1.3V	V
PSRR	Power Supply Rejection Ratio	V ⁺ = 2V to 11V (LTC1841), V ⁺ = 2.5V to 11V (LTC1842/LTC1843)		0.1	1	mV/V
CMRR	Common Mode Rejection Ratio	V _{CM} = V ⁻ to (V ⁺ - 1.3V) LTC1841	●	0.1	1	mV/V
V _{HYST}	Hysteresis Input Voltage Range	LTC1842/LTC1843	●	V _{REF} - 50mV	V _{REF}	V

ELECTRICAL CHARACTERISTICS $V^+ = 5V$, $V^- = 0V$, $T_A = 25^\circ C$ unless otherwise noted.

SYMBOL	PARAMETER	CONDITIONS	MIN	TYP	MAX	UNITS
t_{PD}	Propagation Delay	$C_{OUT} = 10pF$, $R_{PULL-UP} = 100k$		12 4		μs μs
I_{LEAK}	Output Leakage Current	$V_{OUT} = 12V$ (Note 2)	●	1	100	nA
V_{OL}	Output Low Voltage	$I_{OUT} = 1.8mA$	●		$V^- + 0.4V$	V

Reference (LTC1842/LTC1843)

V_{REF}	Reference Voltage	No Load	25°C	1.174	1.182	1.190	V
			0°C to 70°C	●	1.170	1.194	V
			-40°C to 85°C	●	1.164	1.200	V
$ \Delta V_{REF} $	Load Regulation	$I_{SOURCE} = 1mA$	●	1	3	mV	
		$I_{SINK} = 10\mu A$	●	1.75	4	mV	
e_n	Voltage Noise	100Hz to 100kHz		100		μV_{RMS}	

 $V^+ = 3V$, $V^- = 0V$, $T_A = 25^\circ C$ unless otherwise noted.

SYMBOL	PARAMETER	CONDITIONS	MIN	TYP	MAX	UNITS
Power Supply						
V^+	Supply Voltage Range	LTC1841	●	2.0	11	V
		LTC1842/LTC1843	●	2.5	11	V
I_{CC}	Supply Current	$HYST = REF$ (Note 2)	●	3.5	5.5	μA

Comparator

V_{OS}	Comparator Input Offset Voltage	(Note 3)	●	± 3	± 10	mV
I_{IN}	Input Leakage Current (IN^+ , IN^-)	$IN^+ = IN^- = 1.5V$ (LTC1841), $IN^+ = IN^- = V_{REF}$ (LTC1842/LTC1843)	●	± 0.01	± 1	nA
V_{IN}	Comparator Input Voltage Range		●	V^-	$V^+ - 1.3V$	V
PSRR	Power Supply Rejection Ratio	$V^+ = 2V$ to 11V (LTC 1841), $V^+ = 2.5V$ to 11V (LTC1842/LTC1843)		0.1	1	mV/V
CMRR	Common Mode Rejection Ratio	$V_{CM} = V^-$ to ($V^+ - 1.3V$) LTC1841	●	0.1	1	mV/V
V_{HYST}	Hysteresis Input Voltage Range	LTC1842/LTC1843	●	$V_{REF} - 50mV$	V_{REF}	V
t_{PD}	Propagation Delay	$C_{OUT} = 10pF$, $R_{PULL-UP} = 100k$		14 5		μs μs
I_{LEAK}	Output Leakage Current	$V_{OUT} = 12V$ (Note 2)	●	1	100	nA
V_{OL}	Output Low Voltage	$I_O = 0.8mA$	●		$V^- + 0.4V$	V

Reference (LTC1842/LTC1843)

V_{REF}	Reference Voltage	No Load	25°C	1.174	1.182	1.190	V
			0°C to 70°C	●	1.170	1.194	V
			-40°C to 85°C	●	1.164	1.200	V
$ \Delta V_{REF} $	Load Regulation	$I_{SOURCE} = 1mA$	●	2	6	mV	
		$I_{SINK} = 10\mu A$	●	1.75	4	mV	
e_n	Voltage Noise	100Hz to 100kHz		100		μV_{RMS}	

The ● denotes specifications which apply over the full operating temperature range.

Note 1: Absolute Maximum Ratings are those values beyond which the life of a device may be impaired.

Note 2: $IN^+ = IN^- + 80mV$, output is in high impedance state.

Note 3: $V_{CM} = 1/2(V^+ - V^-)$ for LTC1841, $V_{CM} = V_{REF}$ for LTC1842/LTC1843.

TYPICAL PERFORMANCE CHARACTERISTICS

Comparator Response Time vs Input Overdrive, with $R_{PULL-UP} = 5k$

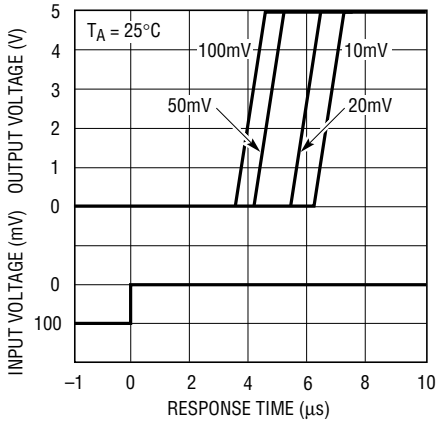

1440/1/2/3 G01

Comparator Response Time vs Input Overdrive, with $R_{PULL-UP} = 5k$

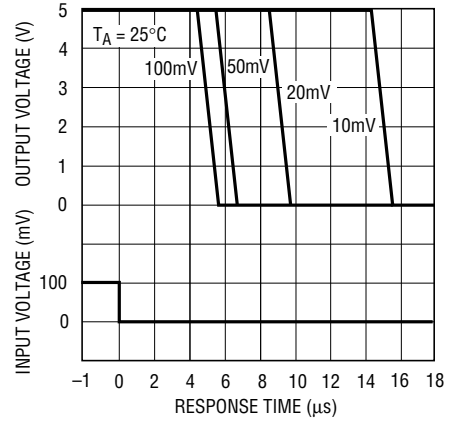

1440/1/2/3 G02

Comparator Short-Circuit Sink Current vs Supply Voltage

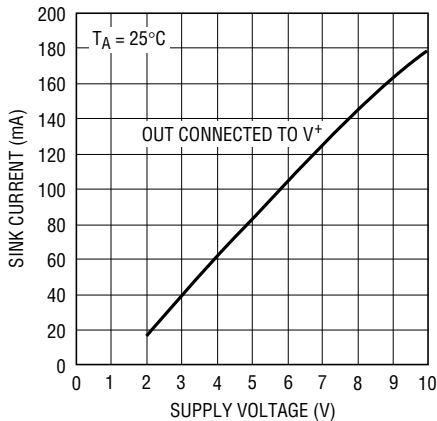

1440/1/2/3 G03

Comparator Response Time vs Load Capacitance with 100mV Input Overdrive

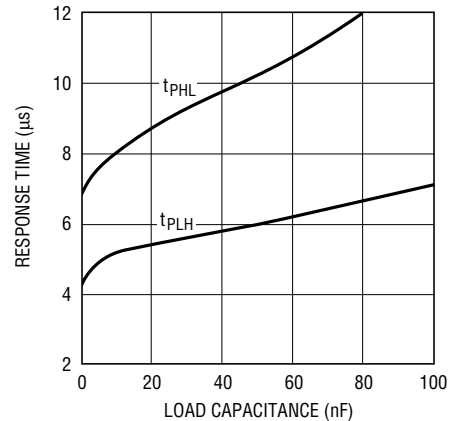

1440/1/2/3 G04

Comparator Response Time at Low Supply Voltage

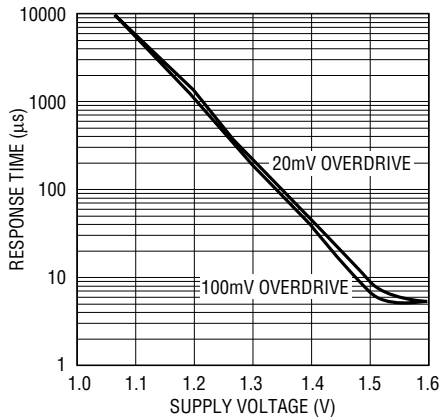

1440/1/2/3 G05

Comparator Output Voltage Low vs Load Current

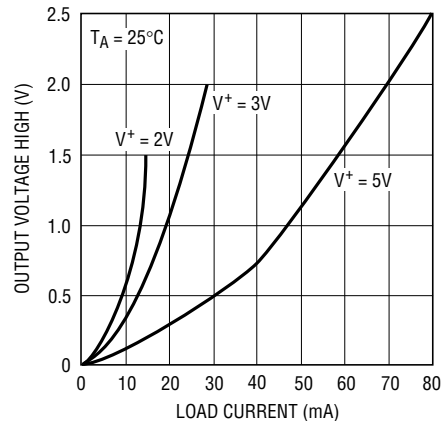

1440/1/2/3 G06

TYPICAL PERFORMANCE CHARACTERISTICS

**LTC1842/LTC1843
Hysteresis Control**

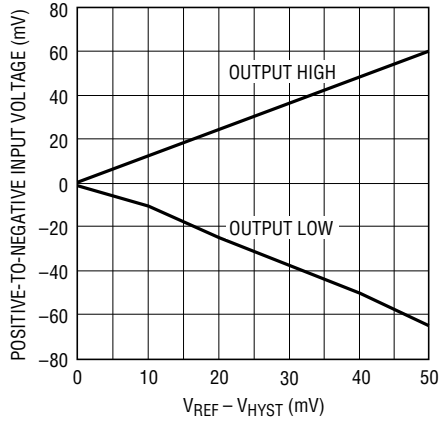

1440/1/2/3 G07

**LTC1842/LTC1843
Supply Current vs Temperature**

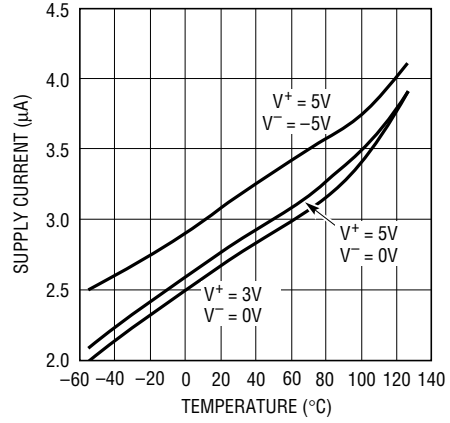

1440/1/2/3 G08

**Reference Output Voltage vs
Output Load Current**

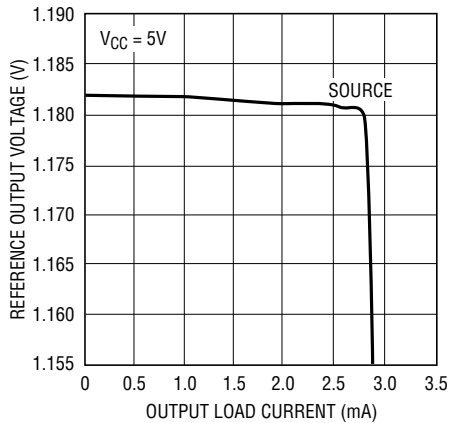

1841/2/3 G09

**Reference Output Voltage vs Output
Load Current (Sink)**

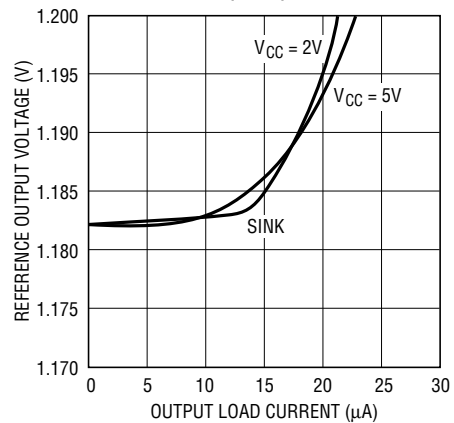

1440/1/2/3 G10

**Reference Voltage vs
Temperature**

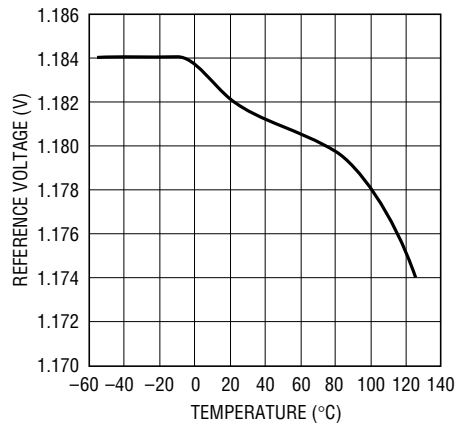

1440/1/2/3 G11

LTC1841/LTC1842/LTC1843

PIN FUNCTIONS

OUT A (Pin 1): Comparator A Open-Drain Output. Output can typically sink greater than 20mA.

V⁻ (Pin 2): Negative Supply.

IN A⁺ (Pin 3): Noninverting Input of Comparator A. Input common mode range extends from V⁻ to V⁺ - 1.3V. Input current is typically 10pA at 25°C.

IN A⁻ (Pin 4) (LTC1841): Inverting Input of Comparator A. Input common mode range extends from V⁻ to V⁺ - 1.3V. Input current is typically 10pA at 25°C.

IN B⁺ (Pin 4) (LTC1842): Noninverting Input of Comparator B. Input common mode range extends from V⁻ to V⁺ - 1.3V. Input current is typically 10pA at 25°C.

IN B⁻ (Pin 4) (LTC1843): Inverting Input of Comparator B. Input common mode range extends from V⁻ to V⁺ - 1.3V. Input current is typically 10pA at 25°C.

IN B⁻ (Pin 5) (LTC1841): Inverting Input of Comparator B. Input common mode range extends from V⁻ to V⁺ - 1.3V. Input current is typically 10pA at 25°C.

HYST (Pin 5) (LTC1842/LTC1843): Hysteresis Input. Connect to REF if not used. Input voltage range is from V_{REF} to V_{REF} - 50mV.

IN B⁺ (Pin 6) (LTC1841): Noninverting Input of Comparator B. Input common mode range extends from V⁻ to V⁺ - 1.3V. Input current is typically 10pA at 25°C.

REF (Pin 6) (LTC1842/LTC1843): Reference Output. 1.182V with respect to V⁻. Can typically source greater than 1mA and sink 10μA at 25°C. Can drive 0.01μF bypass capacitor without oscillation.

V⁺ (Pin 7) (LTC1841): Positive Supply. 2V to 11V.

V⁺ (Pin 7) (LTC1842/LTC1843): Positive Supply. 2.5V to 11V.

OUT B (Pin 8): Comparator B Open-Drain Output. Output can typically sink greater than 20mA.

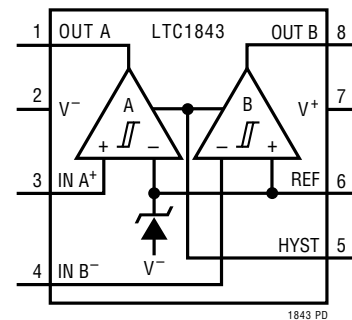
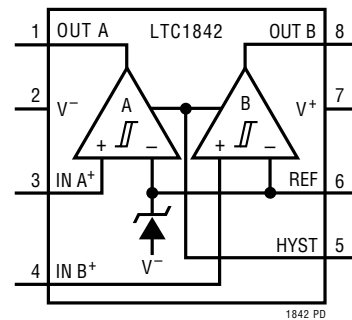
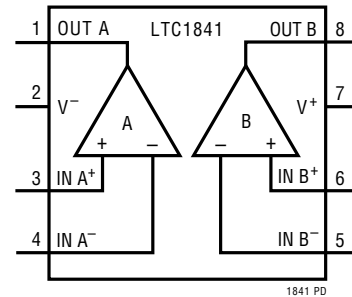

APPLICATIONS INFORMATION

The LTC1841/LTC1842/LTC1843 are dual micropower comparators with a built-in 1.182V reference (LTC1842/LTC1843). Features include programmable hysteresis, wide supply voltage range (2V to 11V) and the ability for the reference to drive up to a 0.01 μ F capacitor without oscillation. The comparators' open-drain outputs can typically sink greater than 20mA and the supply current glitches that normally occur when switching logic states have been eliminated.

Power Supplies

The comparators operate from a single 2V to 11V (2.5V to 11V for LTC1842/LTC1843) or dual ± 1 V to ± 5.5 V supply (± 1.25 V to ± 5.5 V for LTC1842/LTC1843). If the reference output is required to source more than 1mA or the supply source impedance is high, V^+ should be bypassed with a 0.1 μ F capacitor.

Comparator Inputs

The comparators' input can swing from the negative supply V^- to within 1.3V (max) of the positive supply V^+ . The input can be forced 300mV below V^- or above V^+ without damage and the typical input leakage current is only ± 10 pA.

Comparator Outputs

Each comparator output is an open-drain pull-down to V^- typically capable of sinking greater than 20mA. The low output leakage current while in three-state mode allows a high value pull-up resistor to be used. The open-drain outputs can be wire OR-ed or used in level shifting applications.

Voltage Reference

The internal bandgap reference has an output voltage of 1.182V referenced to V^- . The reference accuracy is 1.5% from -40°C to 85°C . It can typically source greater than 1mA and sink up to 10 μ A with a 5V supply. The reference can drive a bypass capacitor of up to 0.01 μ F without oscillation. By inserting a series resistor, capacitance values up to 100 μ F can be used (Figure 1).

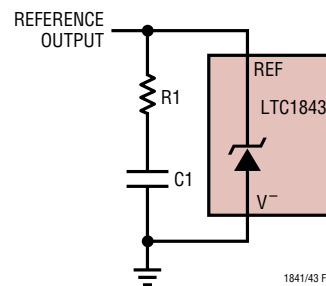

Figure 1. Damping the Reference Output

Figure 2 shows the resistor value required for different capacitor values to achieve critical damping. Bypassing the reference can help prevent false tripping of the comparators by preventing glitches on V^+ or reference load transients from disturbing the reference output voltage.

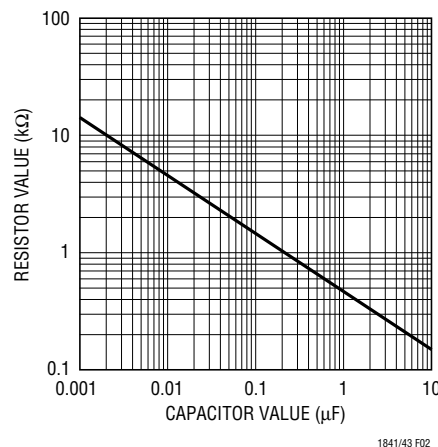

Figure 2. Damping Resistance vs Bypass Capacitor Value

Figure 3 shows the bypassed reference output with a square wave applied to the V^+ pin. Resistors R2 and R3 set a 10mV hysteresis voltage band while R1 damps the reference response. Note that the comparator output doesn't trip.

APPLICATIONS INFORMATION

1. Choose the required hysteresis voltage band and calculate values for R4 and R5 according to the formulas in the hysteresis section. In this example, $\pm 5\text{mV}$ of hysteresis has been added at the comparator input ($V_H = V_{HB}/2$). Note that the hysteresis apparent at V_{IN} will be larger because of the input resistor divider.
2. Select R1. The leakage current into IN^- is under 1nA so the current through R1 should exceed 100nA , to ensure threshold accuracy. R1 values up to about 10M can be used, but values in the 100k to 1M range are usually easier to deal with. In this example choose $R1 = 294\text{k}$.

3. Calculate $R2 + R3$. The overvoltage threshold should be set at 5.5V . The design equation is as follows:

$$\begin{aligned} R2 + R3 &= R1 \left(\frac{V_{UTH}}{V_{REF} + V_H} - 1 \right) \\ &= 294\text{k} \left(\frac{5.5}{1.182 + 0.005} - 1 \right) \\ &= 1.068\text{M} \end{aligned}$$

4. Calculate R2. The undervoltage threshold should be set at 4.5V . The design equation is as follows:

$$\begin{aligned} R2 &= (R1 + R2 + R3) \frac{V_{REF} - V_H - R1}{V_{LTH}} \\ &= (294\text{k} + 1.068\text{M}) \frac{1.182 - 0.005}{4.5} - 294\text{k} \\ &= 62.2\text{k} \end{aligned}$$

Choose $R2 = 61.9\text{k}$ (1% standard value)

5. Calculate R3:

$$\begin{aligned} R3 &= (R2 + R3) - R2 \\ &= 1.068\text{M} - 61.9\text{k} \\ &= 1.006\text{M} \end{aligned}$$

Choose $R3 = 1\text{M}$ (1% standard value)

6. Verify the resistor values. The equations are as follows, evaluated for the above example:

Overvoltage threshold:

$$\begin{aligned} V_{OTH} &= (V_{REF} + V_H) \frac{R1 + R2 + R3}{R1} \\ &= 5.474\text{V} \end{aligned}$$

Undervoltage threshold:

$$\begin{aligned} V_{UTH} &= (V_{REF} - V_H) \frac{R1 + R2 + R3}{R1 + R2} \\ &= 4.484\text{V} \end{aligned}$$

where the hysteresis voltage $V_H = (V_{REF}) \left(\frac{R5}{R4} \right)$

PACKAGE DESCRIPTION Dimensions in inches (millimeters) unless otherwise noted.

S8 Package
8-Lead Plastic Small Outline (Narrow 0.150)
 (LTC DWG # 05-08-1610)

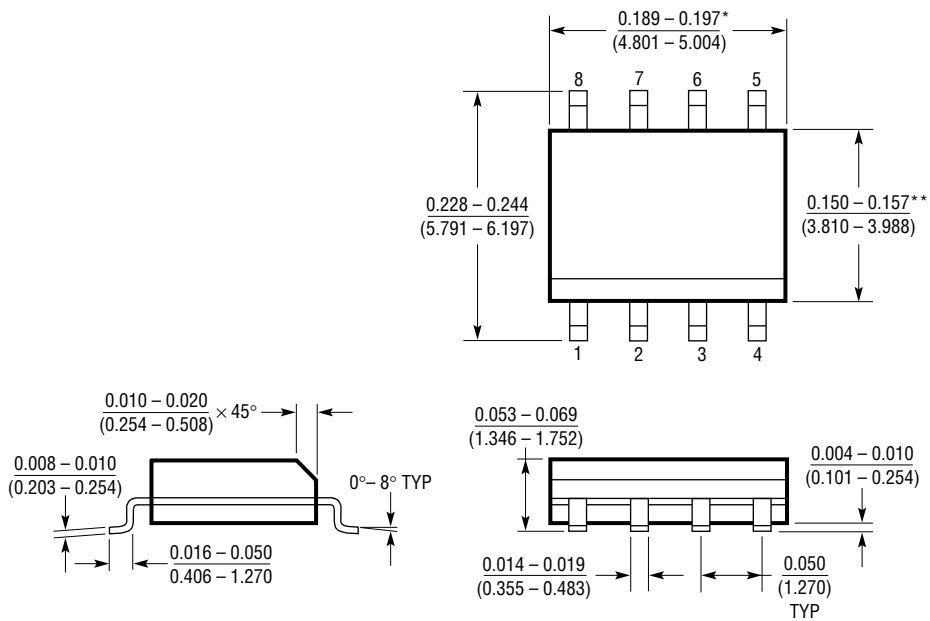

* DIMENSION DOES NOT INCLUDE MOLD FLASH. MOLD FLASH SHALL NOT EXCEED 0.006" (0.152mm) PER SIDE
 ** DIMENSION DOES NOT INCLUDE INTERLEAD FLASH. INTERLEAD FLASH SHALL NOT EXCEED 0.010" (0.254mm) PER SIDE

S08 0996

TYPICAL APPLICATION

Low-Battery Load Disconnect and Charge Termination

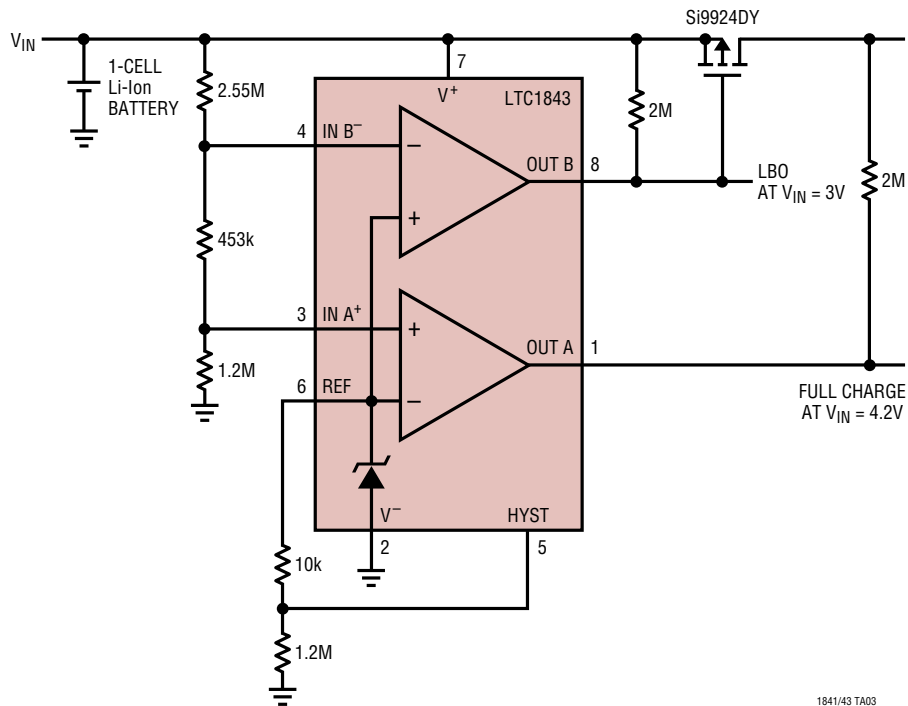

RELATED PARTS

PART NUMBER	DESCRIPTION	COMMENTS
LT [®] 1178/LT1179	Dual/Quad 17 μ A Precision Single Supply Op Amps	70 μ V Max V_{OS} , 5nA Max I_{BIAS}
LT1351	Single 250 μ A, 3MHz, 200V/ μ s Op Amp with Shutdown	C-Load [™] Op Amp Stable Driving Any Capacitive Load
LT1352/LT1353	Dual/Quad 250 μ A, 3MHz, 200V/ μ s Op Amps	C-Load Op Amps Stable Driving Any Capacitive Load
LTC1440/LTC1540	Micropower Comparator with 1% Reference	1.182V \pm 1% Reference, \pm 10mV (Max) Input Offset
LTC1441/LTC1442	Micropower Dual Comparator with 1% Reference	1.182V \pm 1% Reference (LTC1442)
LTC1443/LTC1444/LTC1445	Micropower Quad Comparator with 1% Reference	LTC1443 Has 1.182V Reference, LTC1444/LTC1445 Have 1.221V Reference and Adjustable Hysteresis
LTC1474	Low Quiescent Current High Efficiency Step-Down Switching Regulator	10 μ A Standby Current, 92% Efficiency, Space Saving 8-Pin MSOP Package
LT1495	1.5 μ A Max, Dual Precision Rail-to-Rail Input and Output Op Amp	375 μ V Max V_{OS} , 250pA I_{BIAS} , 25pA I_{OS}
LT1521	300mA Low Dropout Regulator with Micropower Quiescent Current and Shutdown	0.5V Dropout Voltage, 12 μ A Quiescent Current, Adjustable Output 3V, 3.3V and 5V Fixed
LTC1541/LTC1542	Micropower Op Amp, Comparator and Reference	1.200V \pm 0.8% Reference (LTC1541) Op Amp Outputs Stable with 1000pF Load
LT1634	Micropower Precision Shunt Voltage Reference	1.25V Output, 10 μ A Operating Current, 0.1% Initial Accuracy 10ppm/ $^{\circ}$ C Max Drift

C-Load is a trademark of Linear Technology Corporation.

Looking for pricing, stock, or lifecycle information?

Click below to explore more details on WIN SOURCE:

 [View LTC1843IS8 on WIN SOURCE](#)

 [Linear Technology](#) Information

Optimize Your Supply Chain with WIN SOURCE Solutions

-  Global Sourcing Solution
-  Obsolete Management
-  Cost Control Management
-  Shortage Management
-  Alternative Solution
-  Excess Inventory Management