



**THE DATASHEET OF  
LT1884CS8#PBF**



# Dual/Quad Rail-to-Rail Output, Picoamp Input Precision Op Amps

## FEATURES

- **Offset Voltage: 50 $\mu$ V Max (LT1884A)**
- **Input Bias Current: 400pA Max (LT1884A)**
- **Offset Voltage Drift: 0.8 $\mu$ V/ $^{\circ}$ C Max**
- **Rail-to-Rail Output Swing**
- Operates with Single or Split Supplies
- Open-Loop Voltage Gain: 1 Million Min
- 1mA Maximum Supply Current Per Amplifier
- Slew Rate: 1V/ $\mu$ s
- Standard Pinouts

## APPLICATIONS

- Thermocouple Amplifiers
- Bridge Transducer Conditioners
- Instrumentation Amplifiers
- Battery-Powered Systems
- Photo Current Amplifiers
- Precision Integrators
- Precision Current Sources

## DESCRIPTION

The LT<sup>®</sup>1884/LT1885 op amps bring high accuracy input performance to amplifiers with rail-to-rail output swing while providing faster response than other precision amplifiers. Input offset voltage is trimmed to less than 50 $\mu$ V and the low drift maintains this accuracy over the operating temperature range. Input bias currents are an ultralow 400pA maximum.

The amplifiers work on any total power supply voltage between 2.7V and 36V (fully specified from 5V to  $\pm$ 15V). Output voltage swings to within 40mV of the negative supply and 220mV of the positive supply make these amplifiers good choices for low voltage single supply operation.

Slew rates of 1V/ $\mu$ s with a supply current of less than 1mA per amplifier give superior response and settling time performance in a low power precision amplifier.

The dual LT1884 is available with standard pinouts in 8-pin SO and PDIP packages. The quad LT1885 is also in the standard pinout 14-pin SO package.

LT, LTC and LT are registered trademarks of Linear Technology Corporation.

## TYPICAL APPLICATION

Input Fault Protected Instrumentation Amplifier

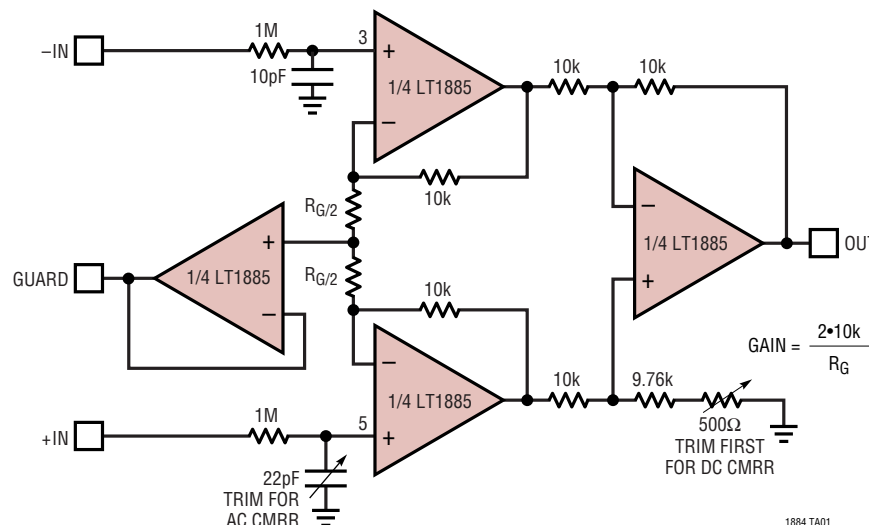

1884 TA01

# LT1884/LT1885

## ABSOLUTE MAXIMUM RATINGS (Note 1)

|                                              |                   |                                            |                                                |
|----------------------------------------------|-------------------|--------------------------------------------|------------------------------------------------|
| Supply Voltage ( $V^+$ to $V^-$ ) .....      | 40V               | Operating Temperature Range (Note 4) ..    | $-40^{\circ}\text{C}$ to $85^{\circ}\text{C}$  |
| Differential Input Voltage (Note 2) .....    | $\pm 10\text{V}$  | Specified Temperature Range (Note 5) ...   | $-40^{\circ}\text{C}$ to $85^{\circ}\text{C}$  |
| Input Voltage .....                          | $V^+$ to $V^-$    | Maximum Junction Temperature .....         | $150^{\circ}\text{C}$                          |
| Input Current (Note 2) .....                 | $\pm 10\text{mA}$ | Storage Temperature Range .....            | $-65^{\circ}\text{C}$ to $150^{\circ}\text{C}$ |
| Output Short-Circuit Duration (Note 3) ..... | Indefinite        | Lead Temperature (Soldering, 10 sec) ..... | $300^{\circ}\text{C}$                          |

## PACKAGE/ORDER INFORMATION

|                                                                                                                                                                                                                                                                                             |                                                                                                          |                                                                                                                                              |                      |
|---------------------------------------------------------------------------------------------------------------------------------------------------------------------------------------------------------------------------------------------------------------------------------------------|----------------------------------------------------------------------------------------------------------|----------------------------------------------------------------------------------------------------------------------------------------------|----------------------|
| <p>N8 PACKAGE<br/>8-LEAD PDIP</p> <p>S8 PACKAGE<br/>8-LEAD PLASTIC SO</p> <p><math>T_{JMAX} = 150^{\circ}\text{C}</math>, <math>\theta_{JA} = 130^{\circ}\text{C/W}</math> (N8)<br/> <math>T_{JMAX} = 150^{\circ}\text{C}</math>, <math>\theta_{JA} = 190^{\circ}\text{C/W}</math> (S8)</p> | ORDER PART NUMBER                                                                                        | <p>S PACKAGE<br/>14-LEAD PLASTIC SO</p> <p><math>T_{JMAX} = 150^{\circ}\text{C}</math>, <math>\theta_{JA} = 110^{\circ}\text{C/W}</math></p> | ORDER PART NUMBER    |
|                                                                                                                                                                                                                                                                                             | LT1884CN8<br>LT1884CS8<br>LT1884ACN8<br>LT1884ACS8<br>LT1884IN8<br>LT1884IS8<br>LT1884AIN8<br>LT1884AIS8 |                                                                                                                                              | LT1885CS<br>LT1885IS |
|                                                                                                                                                                                                                                                                                             | S8 PART MARKING                                                                                          |                                                                                                                                              |                      |
|                                                                                                                                                                                                                                                                                             | 1884    1884I<br>1884A    1884AI                                                                         |                                                                                                                                              |                      |

Consult factory for Military grade parts.

## ELECTRICAL CHARACTERISTICS

The ● denotes the specifications which apply over the full operating temperature range, otherwise specifications are at  $T_A = 25^{\circ}\text{C}$ .  
 Single supply operation  $V_{EE} = 0$ ,  $V_{CC} = 5\text{V}$ ;  $V_{CM} = V_{CC}/2$  unless otherwise noted. (Note 5)

| SYMBOL   | PARAMETER                            | CONDITIONS                                       | MIN | TYP | MAX  | UNITS                          |
|----------|--------------------------------------|--------------------------------------------------|-----|-----|------|--------------------------------|
| $V_{OS}$ | Input Offset Voltage (LT1884A)       | $0^{\circ}\text{C} < T_A < 70^{\circ}\text{C}$   |     | 25  | 50   | $\mu\text{V}$                  |
|          |                                      | $-40^{\circ}\text{C} < T_A < 85^{\circ}\text{C}$ | ●   |     | 85   | $\mu\text{V}$                  |
|          |                                      |                                                  | ●   |     | 110  | $\mu\text{V}$                  |
|          | Input Offset Voltage (LT1884/LT1885) | $0^{\circ}\text{C} < T_A < 70^{\circ}\text{C}$   |     | 30  | 80   | $\mu\text{V}$                  |
|          |                                      | $-40^{\circ}\text{C} < T_A < 85^{\circ}\text{C}$ | ●   |     | 125  | $\mu\text{V}$                  |
|          |                                      |                                                  | ●   |     | 150  | $\mu\text{V}$                  |
|          | Input Offset Voltage Drift (Note 6)  | $0^{\circ}\text{C} < T_A < 70^{\circ}\text{C}$   | ●   | 0.3 | 0.8  | $\mu\text{V}/^{\circ}\text{C}$ |
|          |                                      | $-40^{\circ}\text{C} < T_A < 85^{\circ}\text{C}$ | ●   | 0.3 | 0.8  | $\mu\text{V}/^{\circ}\text{C}$ |
|          |                                      |                                                  |     |     |      |                                |
| $I_{OS}$ | Input Offset Current (LT1884A)       | $0^{\circ}\text{C} < T_A < 70^{\circ}\text{C}$   |     | 100 | 300  | $\text{pA}$                    |
|          |                                      | $-40^{\circ}\text{C} < T_A < 85^{\circ}\text{C}$ | ●   |     | 400  | $\text{pA}$                    |
|          |                                      |                                                  | ●   |     | 500  | $\text{pA}$                    |
|          | Input Offset Current (LT1884/LT1885) | $0^{\circ}\text{C} < T_A < 70^{\circ}\text{C}$   |     | 150 | 900  | $\text{pA}$                    |
|          |                                      | $-40^{\circ}\text{C} < T_A < 85^{\circ}\text{C}$ | ●   |     | 1200 | $\text{pA}$                    |
|          |                                      |                                                  | ●   |     | 1400 | $\text{pA}$                    |

## ELECTRICAL CHARACTERISTICS

The ● denotes the specifications which apply over the full operating temperature range, otherwise specifications are at  $T_A = 25^\circ\text{C}$ .  
 Single supply operation  $V_{EE} = 0$ ,  $V_{CC} = 5\text{V}$ ;  $V_{CM} = V_{CC}/2$  unless otherwise noted. (Note 5)

| SYMBOL    | PARAMETER                                            | CONDITIONS                                                                          | MIN            | TYP  | MAX            | UNITS                        |    |
|-----------|------------------------------------------------------|-------------------------------------------------------------------------------------|----------------|------|----------------|------------------------------|----|
| $I_B$     | Input Bias Current (LT1884A)                         | $0^\circ\text{C} < T_A < 70^\circ\text{C}$ ●                                        |                | 100  | 400            | $\mu\text{A}$                |    |
|           |                                                      | $-40^\circ\text{C} < T_A < 85^\circ\text{C}$ ●                                      |                |      | 500            | $\mu\text{A}$                |    |
|           | Input Bias Current (LT1884/LT1885)                   | $0^\circ\text{C} < T_A < 70^\circ\text{C}$ ●                                        |                | 150  | 900            | $\mu\text{A}$                |    |
|           |                                                      | $-40^\circ\text{C} < T_A < 85^\circ\text{C}$ ●                                      |                |      | 1200           | $\mu\text{A}$                |    |
|           | Input Noise Voltage                                  | 0.1Hz to 10Hz                                                                       |                | 0.4  |                | $\mu\text{V}_{\text{P-P}}$   |    |
| $e_n$     | Input Noise Voltage Density                          | $f = 1\text{kHz}$                                                                   |                | 9.5  |                | $\text{nV}/\sqrt{\text{Hz}}$ |    |
| $i_n$     | Input Noise Current Density                          | $f = 1\text{kHz}$                                                                   |                | 0.05 |                | $\text{pA}/\sqrt{\text{Hz}}$ |    |
| $V_{CM}$  | Input Voltage Range                                  |                                                                                     | $V_{EE} + 1.0$ |      | $V_{CC} - 1.0$ | V                            |    |
|           |                                                      |                                                                                     | $V_{EE} + 1.2$ |      | $V_{CC} - 1.2$ | V                            |    |
| CMRR      | Common Mode Rejection Ratio                          | $1\text{V} < V_{CM} < 4\text{V}$                                                    | 108            | 128  |                | dB                           |    |
|           |                                                      | $1.2\text{V} < V_{CM} < 3.8\text{V}$ ●                                              | 106            |      |                | dB                           |    |
| PSRR      | Power Supply Rejection Ratio                         | $V_{EE} = 0$ , $V_{CM} = 1.5\text{V}$                                               |                |      |                |                              |    |
|           |                                                      | $0^\circ\text{C} < T_A < 85^\circ\text{C}$ , $2.7\text{V} < V_{CC} < 32\text{V}$    | 108            | 132  |                | dB                           |    |
|           |                                                      | $T_A = -40^\circ\text{C}$ , $3\text{V} < V_{CC} < 32\text{V}$                       | 108            | 132  |                | dB                           |    |
|           | Minimum Operating Supply Voltage                     |                                                                                     | ●              | 2.4  | 2.7            | V                            |    |
| $A_{VOL}$ | Large-Signal Voltage Gain                            | $R_L = 10\text{k}$ ; $1\text{V} < V_{OUT} < 4\text{V}$                              | ●              | 500  | 1600           | $\text{V}/\text{mV}$         |    |
|           |                                                      |                                                                                     | ●              | 350  |                | $\text{V}/\text{mV}$         |    |
|           |                                                      | $R_L = 2\text{k}$ ; $1\text{V} < V_{OUT} < 4\text{V}$                               | ●              | 400  | 800            | $\text{V}/\text{mV}$         |    |
|           |                                                      |                                                                                     | ●              | 300  |                | $\text{V}/\text{mV}$         |    |
|           |                                                      | $R_L = 1\text{k}$ ; $1\text{V} < V_{OUT} < 4\text{V}$                               | ●              | 300  | 400            | $\text{V}/\text{mV}$         |    |
|           |                                                      |                                                                                     | ●              | 200  |                | $\text{V}/\text{mV}$         |    |
| $V_{OL}$  | Output Voltage Swing Low                             | No Load                                                                             | ●              |      | 20             | 40                           | mV |
|           |                                                      | $I_{SINK} = 100\mu\text{A}$                                                         | ●              |      | 25             | 50                           | mV |
|           |                                                      | $I_{SINK} = 1\text{mA}$                                                             | ●              |      | 70             | 150                          | mV |
|           |                                                      | $I_{SINK} = 5\text{mA}$                                                             | ●              |      | 270            | 600                          | mV |
| $V_{OH}$  | Output Voltage Swing High<br>(Referred to $V_{CC}$ ) | No Load                                                                             | ●              | 120  | 220            | mV                           |    |
|           |                                                      | $I_{SOURCE} = 100\mu\text{A}$                                                       | ●              | 130  | 230            | mV                           |    |
|           |                                                      | $I_{SOURCE} = 1\text{mA}$                                                           | ●              | 180  | 300            | mV                           |    |
|           |                                                      | $I_{SOURCE} = 5\text{mA}$                                                           | ●              | 360  | 600            | mV                           |    |
| $I_S$     | Supply Current per Amplifier                         | $V_{CC} = 3\text{V}$                                                                | ●              | 0.45 | 0.65           | 0.85                         | mA |
|           |                                                      |                                                                                     | ●              |      |                | 1.30                         | mA |
|           |                                                      | $V_{CC} = 5\text{V}$                                                                | ●              | 0.50 | 0.65           | 0.9                          | mA |
|           |                                                      |                                                                                     | ●              |      |                | 1.4                          | mA |
|           |                                                      | $V_{CC} = 12\text{V}$                                                               | ●              | 0.50 | 0.70           | 1.0                          | mA |
|           |                                                      |                                                                                     | ●              |      |                | 1.5                          | mA |
| $I_{SC}$  | Short-Circuit Current                                | $V_{OUT}$ Short to GND                                                              | ●              | 15   | 30             |                              | mA |
|           |                                                      | $V_{OUT}$ Short to $V_{CC}$                                                         | ●              | 15   | 30             |                              | mA |
| GBW       | Gain-Bandwidth Product                               | $f = 20\text{kHz}$                                                                  |                | 1.2  | 2              | MHz                          |    |
| $t_s$     | Settling Time                                        | 0.01%, $V_{OUT} = 1.5\text{V}$ to $3.5\text{V}$ ,<br>$A_V = -1$ , $R_L = 2\text{k}$ |                | 10   |                | $\mu\text{s}$                |    |
| $SR^+$    | Positive Slew Rate                                   | $A_V = -1$                                                                          | ●              | 0.45 | 0.9            | $\text{V}/\mu\text{s}$       |    |
|           |                                                      |                                                                                     | ●              | 0.36 |                | $\text{V}/\mu\text{s}$       |    |
| $SR^-$    | Negative Slew Rate                                   | $A_V = -1$                                                                          | ●              | 0.35 | 0.7            | $\text{V}/\mu\text{s}$       |    |
|           |                                                      |                                                                                     | ●              | 0.25 |                | $\text{V}/\mu\text{s}$       |    |

## ELECTRICAL CHARACTERISTICS

The ● denotes the specifications which apply over the full operating temperature range, otherwise specifications are at  $T_A = 25^\circ\text{C}$ .  
 Single supply operation  $V_{EE} = 0$ ,  $V_{CC} = 5\text{V}$ ;  $V_{CM} = V_{CC}/2$  unless otherwise noted. (Note 5)

| SYMBOL              | PARAMETER                                          | CONDITIONS                                                                                                                | MIN    | TYP | MAX  | UNITS                                           |
|---------------------|----------------------------------------------------|---------------------------------------------------------------------------------------------------------------------------|--------|-----|------|-------------------------------------------------|
| $\Delta V_{OS}$     | Offset Voltage Match (LT1884A)                     | $0^\circ\text{C} < T_A < 70^\circ\text{C}$                                                                                | ●      | 30  | 70   | $\mu\text{V}$                                   |
|                     |                                                    | $-40^\circ\text{C} < T_A < 85^\circ\text{C}$                                                                              | ●      |     | 125  | $\mu\text{V}$                                   |
|                     | Offset Voltage Match (LT1884/LT1885)               | (Note 7)<br>$0^\circ\text{C} < T_A < 70^\circ\text{C}$<br>$-40^\circ\text{C} < T_A < 85^\circ\text{C}$                    | ●<br>● | 35  | 125  | $\mu\text{V}$<br>$\mu\text{V}$<br>$\mu\text{V}$ |
|                     | Offset Voltage Match Drift                         | (Notes 6, 7)                                                                                                              | ●      | 0.4 | 1.2  | $\mu\text{V}/^\circ\text{C}$                    |
| $\Delta I_{B+}$     | Noninverting Bias Current Match (LT1884A)          | $0^\circ\text{C} < T_A < 70^\circ\text{C}$                                                                                | ●      | 200 | 600  | $\text{pA}$                                     |
|                     |                                                    | $-40^\circ\text{C} < T_A < 85^\circ\text{C}$                                                                              | ●      |     | 700  | $\text{pA}$                                     |
|                     | Noninverting Bias Current Match (LT1884/LT1885)    | (Notes 7, 9)<br>$0^\circ\text{C} < T_A < 70^\circ\text{C}$<br>$-40^\circ\text{C} < T_A < 85^\circ\text{C}$                | ●<br>● | 250 | 1200 | $\text{pA}$<br>$\text{pA}$<br>$\text{pA}$       |
| $\Delta\text{CMRR}$ | Common Mode Rejection Match                        | (Notes 7, 9)                                                                                                              | ●      | 104 | 125  | dB                                              |
| $\Delta\text{PSRR}$ | Positive Power Supply Rejection Match (Notes 7, 9) | $V_{EE} = 0$ , $V_{CM} = 1.5\text{V}$<br>$0^\circ\text{C} < T_A < 85^\circ\text{C}$ , $2.7\text{V} < V_{CC} < 32\text{V}$ | ●      | 104 | 126  | dB                                              |
|                     |                                                    | $T_A = -40^\circ\text{C}$ , $3\text{V} < V_{CC} < 32\text{V}$                                                             | ●      | 104 | 126  | dB                                              |

The ● denotes the specifications which apply over the full operating temperature range, otherwise specifications are at  $T_A = 25^\circ\text{C}$ .  
 Split supply operation  $V_S = \pm 15\text{V}$ ;  $V_{CM} = 0\text{V}$  unless otherwise noted. (Note 5)

| SYMBOL   | PARAMETER                            | CONDITIONS                                                                                 | MIN    | TYP            | MAX            | UNITS                                                        |
|----------|--------------------------------------|--------------------------------------------------------------------------------------------|--------|----------------|----------------|--------------------------------------------------------------|
| $V_{OS}$ | Input Offset Voltage (LT1884A)       | $0^\circ\text{C} < T_A < 70^\circ\text{C}$                                                 | ●      | 25             | 50             | $\mu\text{V}$                                                |
|          |                                      | $-40^\circ\text{C} < T_A < 85^\circ\text{C}$                                               | ●      |                | 85             | $\mu\text{V}$                                                |
|          | Input Offset Voltage (LT1884/LT1885) | $0^\circ\text{C} < T_A < 70^\circ\text{C}$<br>$-40^\circ\text{C} < T_A < 85^\circ\text{C}$ | ●<br>● | 30             | 80             | $\mu\text{V}$<br>$\mu\text{V}$<br>$\mu\text{V}$              |
|          | Input Offset Voltage Drift (Note 6)  | $0^\circ\text{C} < T_A < 70^\circ\text{C}$<br>$-40^\circ\text{C} < T_A < 85^\circ\text{C}$ | ●<br>● | 0.3            | 0.8            | $\mu\text{V}/^\circ\text{C}$<br>$\mu\text{V}/^\circ\text{C}$ |
| $I_{OS}$ | Input Offset Current (LT1884A)       | $0^\circ\text{C} < T_A < 70^\circ\text{C}$                                                 | ●      | 150            | 300            | $\text{pA}$                                                  |
|          |                                      | $-40^\circ\text{C} < T_A < 85^\circ\text{C}$                                               | ●      |                | 400            | $\text{pA}$                                                  |
|          | Input Offset Current (LT1884/LT1885) | $0^\circ\text{C} < T_A < 70^\circ\text{C}$<br>$-40^\circ\text{C} < T_A < 85^\circ\text{C}$ | ●<br>● | 150            | 900            | $\text{pA}$<br>$\text{pA}$<br>$\text{pA}$                    |
| $I_B$    | Input Bias Current (LT1884A)         | $0^\circ\text{C} < T_A < 70^\circ\text{C}$                                                 | ●      | 150            | 400            | $\text{pA}$                                                  |
|          |                                      | $-40^\circ\text{C} < T_A < 85^\circ\text{C}$                                               | ●      |                | 500            | $\text{pA}$                                                  |
|          | Input Bias Current (LT1884/LT1885)   | $0^\circ\text{C} < T_A < 70^\circ\text{C}$<br>$-40^\circ\text{C} < T_A < 85^\circ\text{C}$ | ●<br>● | 150            | 900            | $\text{pA}$<br>$\text{pA}$<br>$\text{pA}$                    |
|          | Input Noise Voltage                  | 0.1Hz to 10Hz                                                                              |        | 0.4            |                | $\mu\text{V}_{P-P}$                                          |
| $e_n$    | Input Noise Voltage Density          | $f = 1\text{kHz}$                                                                          |        | 9.5            |                | $\text{nV}/\sqrt{\text{Hz}}$                                 |
| $i_n$    | Input Noise Current Density          | $f = 1\text{kHz}$                                                                          |        | 0.05           |                | $\text{pA}/\sqrt{\text{Hz}}$                                 |
| $V_{CM}$ | Input Voltage Range                  |                                                                                            | ●      | $V_{EE} + 1.0$ | $V_{CC} - 1.0$ | V                                                            |
|          |                                      |                                                                                            | ●      | $V_{EE} + 1.2$ | $V_{CC} - 1.2$ | V                                                            |
| CMRR     | Common Mode Rejection Ratio          | $-13.5\text{V} < V_{CM} < 13.5\text{V}$                                                    | ●      | 114            | 130            | dB                                                           |

## ELECTRICAL CHARACTERISTICS

The ● denotes the specifications which apply over the full operating temperature range, otherwise specifications are at  $T_A = 25^\circ\text{C}$ . Split supply operation  $V_S = \pm 15\text{V}$ ;  $V_{CM} = 0\text{V}$  unless otherwise noted. (Note 5)

| SYMBOL                | PARAMETER                                            | CONDITIONS                                                                                             |   | MIN  | TYP       | MAX        | UNITS                        |
|-----------------------|------------------------------------------------------|--------------------------------------------------------------------------------------------------------|---|------|-----------|------------|------------------------------|
| +PSRR                 | Positive Power Supply Rejection Ratio                | $V_{EE} = -15\text{V}$ , $V_{CM} = 0\text{V}$ ; $1.5\text{V} < V_{CC} < 18\text{V}$                    | ● | 114  | 132       |            | dB                           |
| -PSRR                 | Negative Power Supply Rejection Ratio                | $V_{CC} = 15\text{V}$ , $V_{CM} = 0\text{V}$ ; $-1.5\text{V} < V_{EE} < -18\text{V}$                   | ● | 106  | 132       |            | dB                           |
|                       | Minimum Operating Supply Voltage                     |                                                                                                        | ● |      | $\pm 1.2$ | $\pm 1.35$ | V                            |
| $A_{VOL}$             | Large-Signal Voltage Gain                            | $R_L = 10\text{k}$ ; $-13.5\text{V} < V_{OUT} < 13.5\text{V}$                                          | ● | 1000 | 1600      |            | V/mV                         |
|                       |                                                      |                                                                                                        | ● | 700  |           |            | V/mV                         |
|                       |                                                      | $R_L = 2\text{k}$ ; $-13.5\text{V} < V_{OUT} < 13.5\text{V}$                                           | ● | 250  | 420       |            | V/mV                         |
|                       |                                                      | $R_L = 1\text{k}$ ; $-12\text{V} < V_{OUT} < 12\text{V}$                                               | ● | 175  |           |            | V/mV                         |
|                       |                                                      |                                                                                                        | ● | 100  | 230       |            | V/mV                         |
|                       |                                                      |                                                                                                        | ● | 75   |           |            | V/mV                         |
| $V_{OL}$              | Output Voltage Swing Low<br>(Referred to $V_{EE}$ )  | No Load                                                                                                | ● |      | 20        | 40         | mV                           |
|                       |                                                      | $I_{SINK} = 100\mu\text{A}$                                                                            | ● |      | 25        | 50         | mV                           |
|                       |                                                      | $I_{SINK} = 1\text{mA}$                                                                                | ● |      | 70        | 150        | mV                           |
|                       |                                                      | $I_{SINK} = 5\text{mA}$                                                                                | ● |      | 270       | 600        | mV                           |
| $V_{OH}$              | Output Voltage Swing High<br>(Referred to $V_{CC}$ ) | No Load                                                                                                | ● |      | 160       | 220        | mV                           |
|                       |                                                      | $I_{SOURCE} = 100\mu\text{A}$                                                                          | ● |      | 160       | 230        | mV                           |
|                       |                                                      | $I_{SOURCE} = 1\text{mA}$                                                                              | ● |      | 180       | 300        | mV                           |
|                       |                                                      | $I_{SOURCE} = 5\text{mA}$                                                                              | ● |      | 360       | 600        | mV                           |
| $I_S$                 | Supply Current Per Amplifier                         | $V_S = \pm 15\text{V}$                                                                                 | ● |      | 0.85      | 1.1        | mA                           |
|                       |                                                      |                                                                                                        | ● |      |           | 1.6        | mA                           |
| $I_{SC}$              | Short-Circuit Current                                | $V_{OUT}$ Short to $V_{EE}$                                                                            | ● | 15   | 50        |            | mA                           |
|                       |                                                      | $V_{OUT}$ Short to $V_{CC}$                                                                            | ● | 15   | 30        |            | mA                           |
| GBW                   | Gain-Bandwidth Product                               | $f = 20\text{kHz}$                                                                                     |   | 1.5  | 2.2       |            | MHz                          |
| $t_S$                 | Settling Time                                        | 0.01%, $V_{OUT} = -5\text{V}$ to $5\text{V}$ ,<br>$A_V = -1$ , $R_L = 2\text{k}$                       |   |      | 17        |            | $\mu\text{s}$                |
| $SR^+$                | Positive Slew Rate                                   | $A_V = -1$                                                                                             | ● | 0.5  | 1.0       |            | V/ $\mu\text{s}$             |
|                       |                                                      |                                                                                                        | ● | 0.4  |           |            | V/ $\mu\text{s}$             |
| $SR^-$                | Negative Slew Rate                                   | $A_V = -1$                                                                                             | ● | 0.40 | 0.7       |            | V/ $\mu\text{s}$             |
|                       |                                                      |                                                                                                        | ● | 0.26 |           |            | V/ $\mu\text{s}$             |
| $\Delta V_{OS}$       | Offset Voltage Match (LT1884A)                       | (Note 7)                                                                                               |   |      | 35        | 70         | $\mu\text{V}$                |
|                       |                                                      | $0^\circ\text{C} < T_A < 70^\circ\text{C}$                                                             | ● |      |           | 125        | $\mu\text{V}$                |
|                       |                                                      | $-40^\circ\text{C} < T_A < 85^\circ\text{C}$                                                           | ● |      |           | 160        | $\mu\text{V}$                |
|                       | Offset Voltage Match (LT1884/LT1885)                 | (Note 7)                                                                                               |   |      | 35        | 125        | $\mu\text{V}$                |
|                       |                                                      | $0^\circ\text{C} < T_A < 70^\circ\text{C}$                                                             | ● |      |           | 175        | $\mu\text{V}$                |
|                       |                                                      | $-40^\circ\text{C} < T_A < 85^\circ\text{C}$                                                           | ● |      |           | 235        | $\mu\text{V}$                |
|                       | Offset Voltage Match Drift                           | (Note 6, 7)                                                                                            | ● |      | 0.4       | 1.1        | $\mu\text{V}/^\circ\text{C}$ |
| $\Delta I_B^+$        | Noninverting Bias Current Match<br>(LT1884A)         | (Notes 7, 8)                                                                                           |   |      | 200       | 600        | pA                           |
|                       |                                                      | $0^\circ\text{C} < T_A < 70^\circ\text{C}$                                                             | ● |      |           | 700        | pA                           |
|                       |                                                      | $-40^\circ\text{C} < T_A < 85^\circ\text{C}$                                                           | ● |      |           | 850        | pA                           |
|                       | Noninverting Bias Current Match<br>(LT1884/LT1885)   | (Notes 7, 8)                                                                                           |   |      | 240       | 1200       | pA                           |
|                       |                                                      | $0^\circ\text{C} < T_A < 70^\circ\text{C}$                                                             | ● |      |           | 1600       | pA                           |
|                       |                                                      | $-40^\circ\text{C} < T_A < 85^\circ\text{C}$                                                           | ● |      |           | 1900       | pA                           |
| $\Delta\text{CMRR}$   | Common Mode Rejection Match                          | (Notes 7, 9)                                                                                           | ● | 106  | 125       |            | dB                           |
| $\Delta +\text{PSRR}$ | Positive Power Supply Rejection Match                | $V_{EE} = -15\text{V}$ , $V_{CM} = 0\text{V}$ , $1.5\text{V} < V_{CC} < 18\text{V}$ ,<br>(Notes 7, 9)  | ● | 108  | 124       |            | dB                           |
| $\Delta -\text{PSRR}$ | Negative Power Supply Rejection Match                | $V_{CC} = 15\text{V}$ , $V_{CM} = 0\text{V}$ , $-1.5\text{V} < V_{EE} < -18\text{V}$ ,<br>(Notes 7, 9) | ● | 102  | 132       |            | dB                           |

## ELECTRICAL CHARACTERISTICS

**Note 1:** Absolute Maximum Ratings are those values beyond which the life of the device may be impaired.

**Note 2:** The inputs are protected by back-to-back diodes. If the differential input voltage exceeds 0.7V, the input current should be limited to less than 10mA.

**Note 3:** A heat sink may be required to keep the junction temperature below absolute maximum.

**Note 4:** The LT1884C/LT1885C and LT1884I/LT1885I are guaranteed functional over the operating temperature range of  $-40^{\circ}\text{C}$  to  $85^{\circ}\text{C}$ .

**Note 5:** The LT1884C/LT1885C are designed, characterized and expected to meet specified performance from  $-40^{\circ}\text{C}$  to  $85^{\circ}\text{C}$  but are not tested or QA sampled at these temperatures. LT1884I is guaranteed to meet specified performance from  $-40^{\circ}\text{C}$  to  $85^{\circ}\text{C}$ .

**Note 6:** This parameter is not 100% tested.

**Note 7:** Matching parameters are the difference between amplifiers A and B in the LT1884 and between amplifiers A and D and B and C in the LT1885.

**Note 8:** This parameter is the difference between the two noninverting input bias currents.

**Note 9:**  $\Delta\text{CMRR}$  and  $\Delta\text{PSRR}$  are defined as follows: CMRR and PSRR are measured in  $\mu\text{V}/\text{V}$  on each amplifier. The difference is calculated in  $\mu\text{V}/\text{V}$  and then converted to dB.

## TYPICAL PERFORMANCE CHARACTERISTICS

Distribution of Offset Voltage Drift

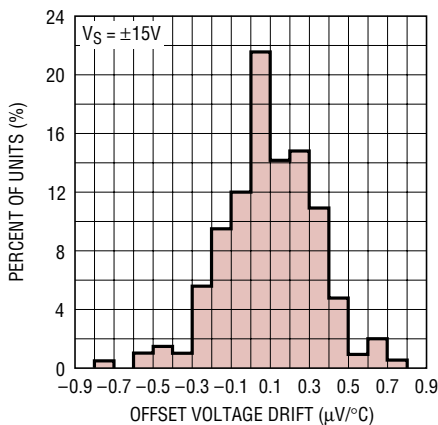

18845 G01

Input Offset Voltage vs Temperature

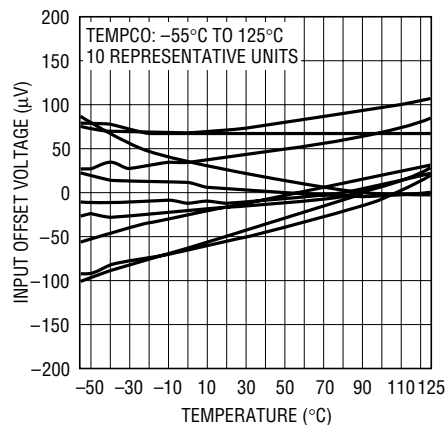

18845 G02

$V_{\text{OUT}}$  vs  $I_{\text{SINK}}$

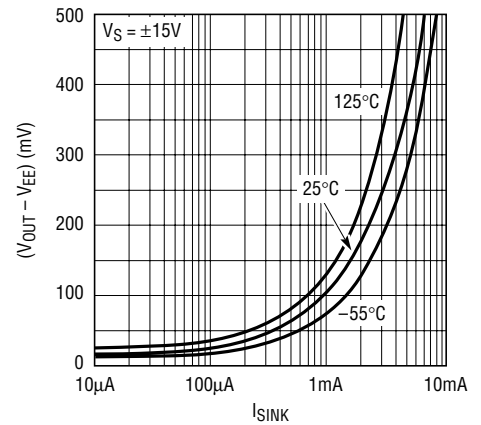

18845 G03

$V_{\text{OUT}}$  vs  $I_{\text{SOURCE}}$

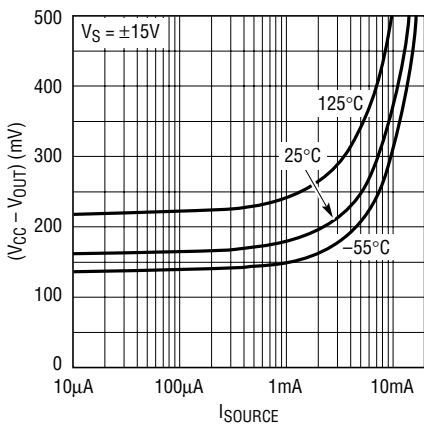

18845 G04

Gain vs Frequency

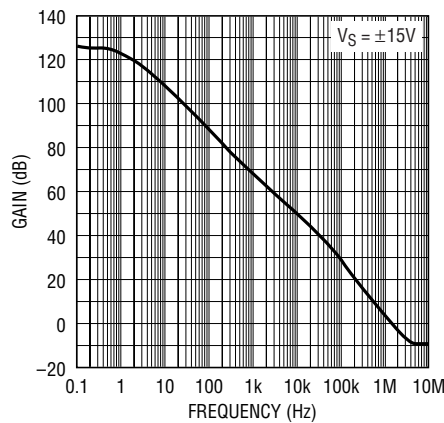

18845 G05

Gain, Phase Shift vs Frequency

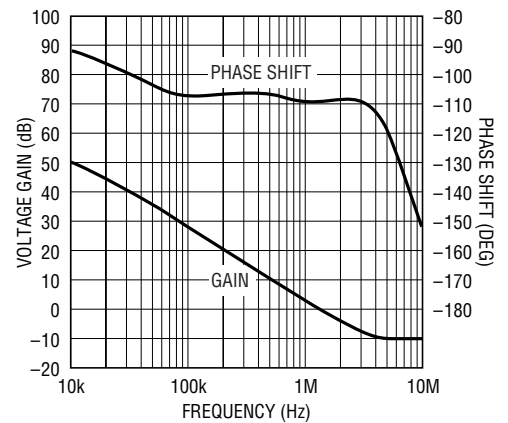

18845 G06

# TYPICAL PERFORMANCE CHARACTERISTICS

CMRR vs Frequency

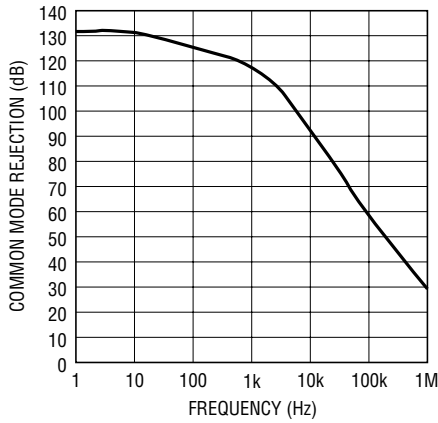

18845 G07

PSRR vs Frequency

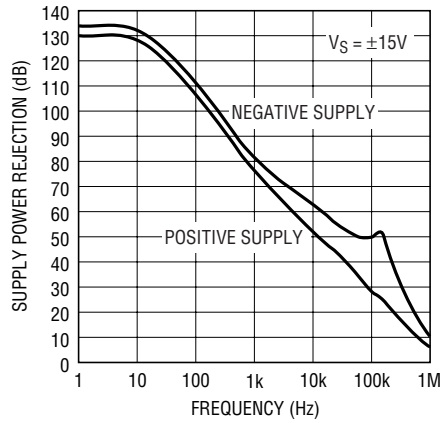

18845 G08

V<sub>n</sub>, I<sub>n</sub> vs Frequency

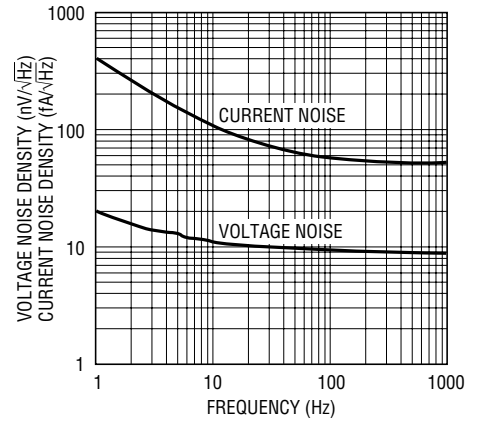

18845 G09

0.1Hz to 10Hz Noise

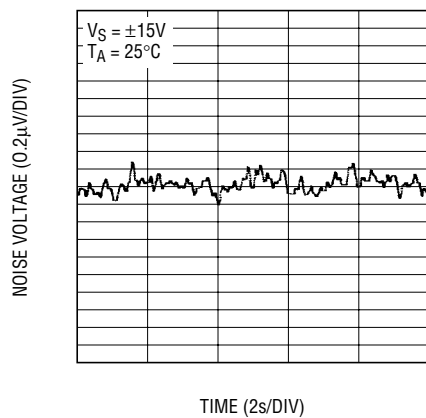

18845 G10

0.01Hz to 1Hz Noise

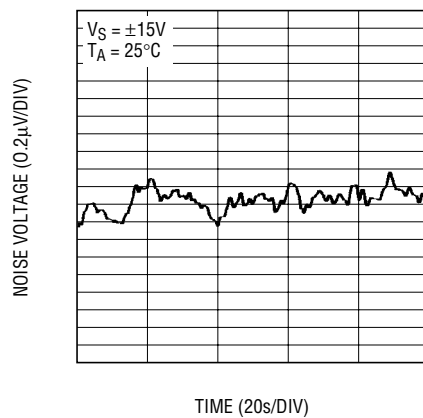

18845 G11

Slew Rate vs Temperature

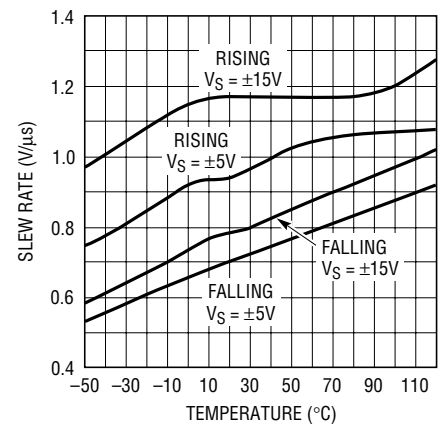

18845 G12

Settling Time to 0.01% vs Output Step

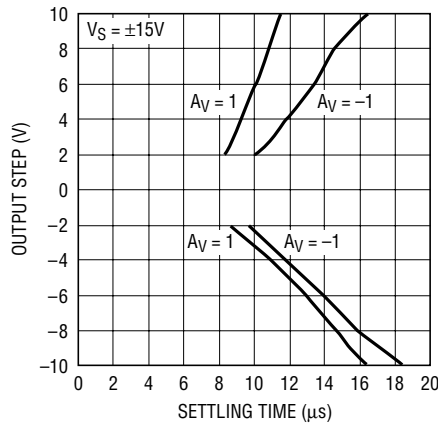

18845 G13

Supply Current per Amplifier vs Supply Voltage

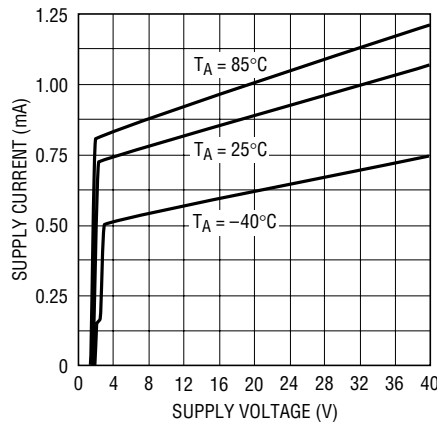

18845 G14

Input Bias Current vs Common Mode Voltage

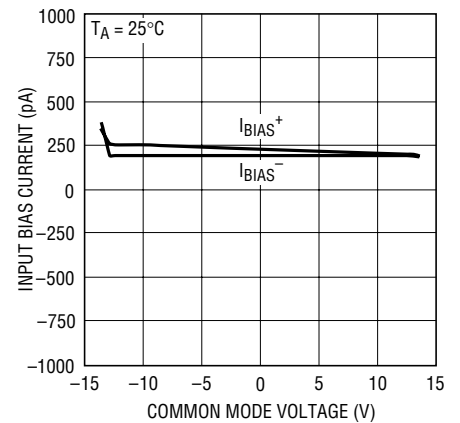

LTXXXX • TPCXX

# TYPICAL PERFORMANCE CHARACTERISTICS

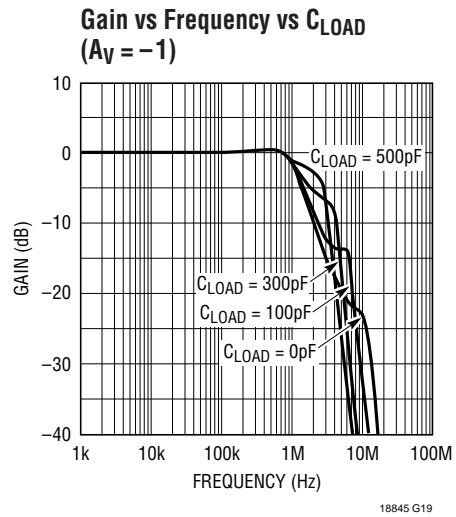
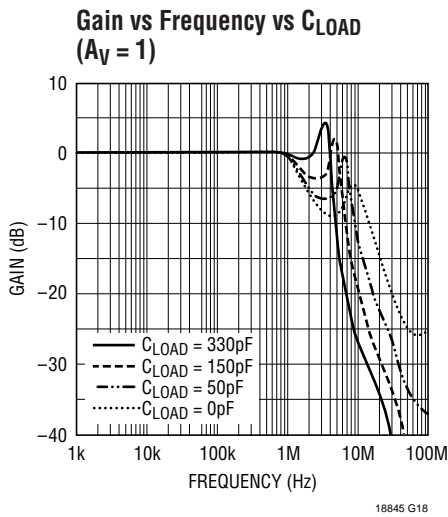
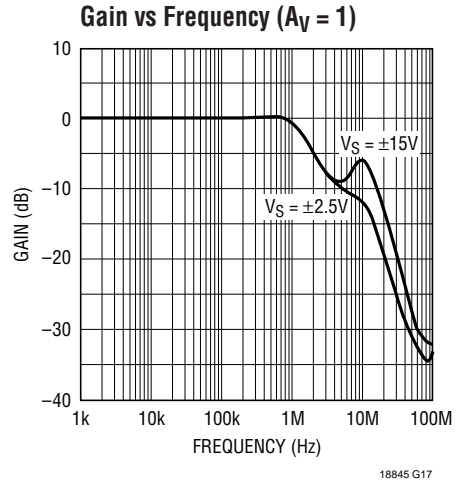
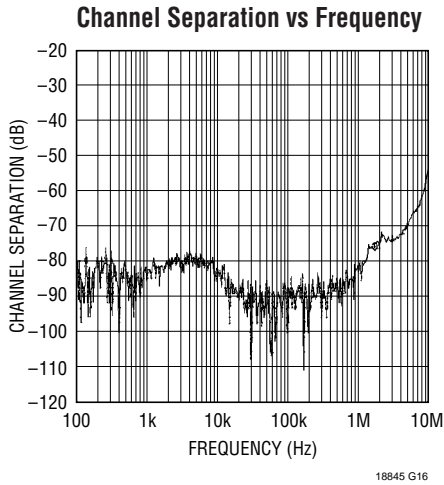

**Large-Signal Response**

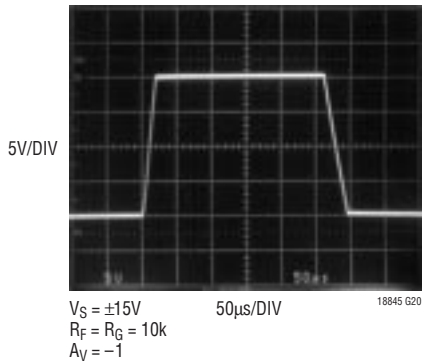

**Small-Signal Response**

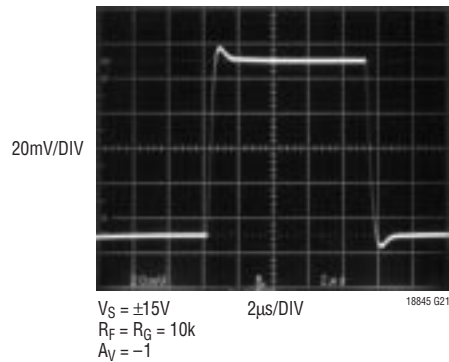

## APPLICATIONS INFORMATION

The LT1884/LT1885 dual op amp features exceptional input precision with rail-to-rail output swing. Slew rate and small-signal bandwidth are superior to other amplifiers with comparable input precision. These characteristics make the LT1884/LT1885 a convenient choice for precision low voltage systems and for improved AC performance in higher voltage precision systems. Maintaining the advantage of the precision inherent in the amplifier depends upon proper applications circuit design and board layout.

### Preserving Input Precision

Preserving the input voltage accuracy of the LT1884/LT1885 requires that the applications circuit and PC board layout do not introduce errors comparable to or greater than the 30 $\mu$ V offset. Temperature differentials across the input connections can generate thermocouple voltages of 10s of microvolts. PC board layouts should keep connections to the amplifier's input pins close together and away from heat dissipating components. Air currents across the board can also generate temperature differentials.

The extremely low input bias currents, 100pA, allow high accuracy to be maintained with high impedance sources and feedback networks. The LT1884/LT1885's low input bias currents are obtained by using a cancellation circuit on-chip. This causes the resulting  $I_{BIAS}^+$  and  $I_{BIAS}^-$  to be uncorrelated, as implied by the  $I_{OS}$  specification being comparable to the  $I_{BIAS}$ . The user should not try to balance the input resistances in each input lead, as is commonly recommended with most amplifiers. The impedance at either input should be kept as small as possible to minimize total circuit error.

PC board layout is important to ensure that leakage currents do not corrupt the low  $I_{BIAS}$  of the amplifier. In high precision, high impedance circuits, the input pins should be surrounded by a guard ring of PC board

interconnect, with the guard driven to the same common mode voltage as the amplifier inputs.

### Input Common Mode Range

The LT1884/LT1885 output is able to swing close to each power supply rail, but the input stage is limited to operating between  $V_{EE} + 0.8V$  and  $V_{CC} - 0.9V$ . Exceeding this common mode range will cause the gain to drop to zero; however, no gain reversal will occur.

### Input Protection

The inverting and noninverting input pins of the LT1884/LT1885 have limited on-chip protection. ESD protection is provided to prevent damage during handling. The input transistors have voltage clamping and limiting resistors to protect against input differentials up to 10V. Short transients above this level will also be tolerated. If the input pins may be subject to a sustained differential voltage above 10V, external limiting resistors should be used to prevent damage to the amplifier. A 1k resistor in each input lead will provide protection against a 30V differential voltage.

### Capacitive Loads

The LT1884/LT1885 can drive capacitive loads up to 300pF when configured for unity gain. The capacitive load driving capability increases as the amplifier is used in higher gain configurations. Capacitive load driving may also be increased by decoupling the capacitance from the output with a small resistance.

### Input Bias Currents

While it may be tempting to seek out a JFET amplifier for low input bias current, remember that bipolar devices improve with temperature while JFETs degrade.

**PACKAGE DESCRIPTION**

Dimensions in inches (millimeters) unless otherwise noted.

**N8 Package**  
**8-Lead PDIP (Narrow 0.300)**  
 (LTC DWG # 05-08-1510)

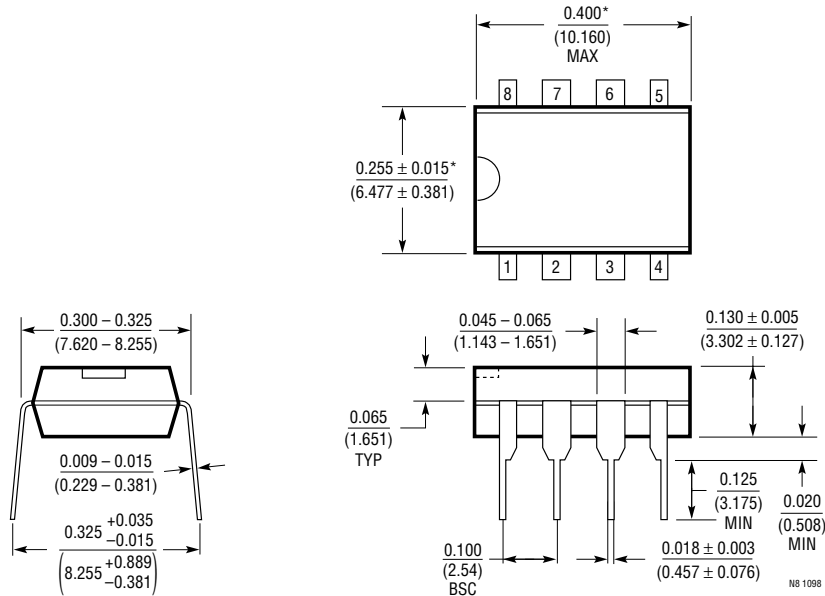

\*THESE DIMENSIONS DO NOT INCLUDE MOLD FLASH OR PROTRUSIONS.  
 MOLD FLASH OR PROTRUSIONS SHALL NOT EXCEED 0.010 INCH (0.254mm)

**S8 Package**  
**8-Lead Plastic Small Outline (Narrow 0.150)**  
 (LTC DWG # 05-08-1610)

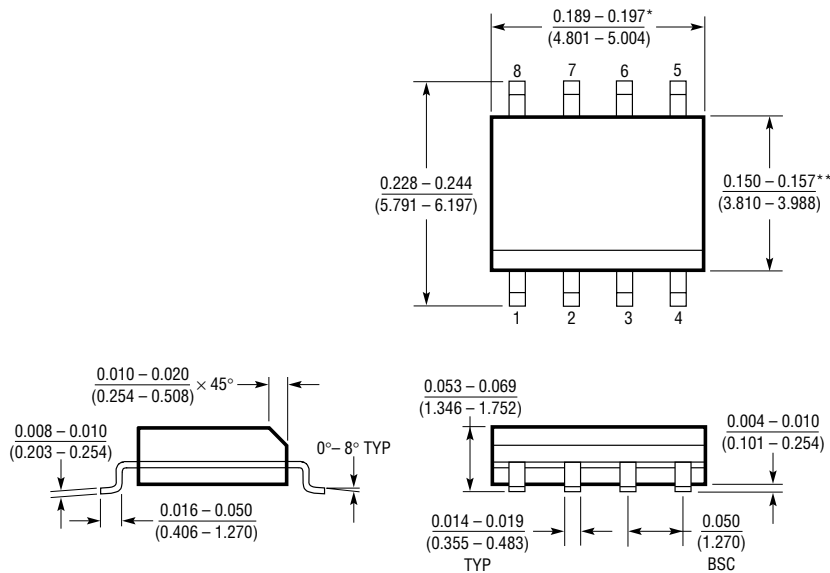

\* DIMENSION DOES NOT INCLUDE MOLD FLASH. MOLD FLASH SHALL NOT EXCEED 0.006" (0.152mm) PER SIDE

\*\* DIMENSION DOES NOT INCLUDE INTERLEAD FLASH. INTERLEAD FLASH SHALL NOT EXCEED 0.010" (0.254mm) PER SIDE

508 1298

**PACKAGE DESCRIPTION** Dimensions in inches (millimeters) unless otherwise noted.

**S Package**  
**14-Lead Plastic Small Outline (Narrow 0.150)**  
 (LTC DWG # 05-08-1610)

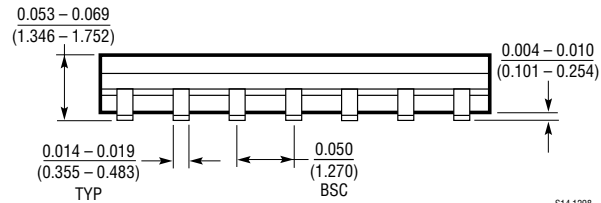
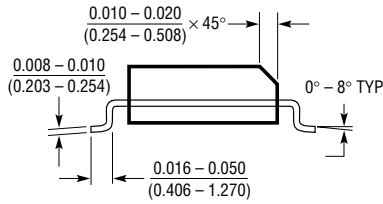
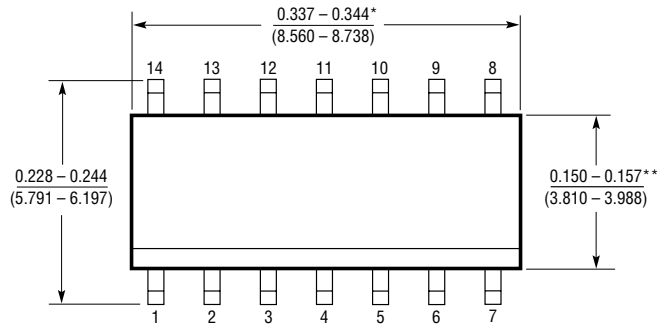

\*DIMENSION DOES NOT INCLUDE MOLD FLASH. MOLD FLASH SHALL NOT EXCEED 0.006" (0.152mm) PER SIDE  
 \*\*DIMENSION DOES NOT INCLUDE INTERLEAD FLASH. INTERLEAD FLASH SHALL NOT EXCEED 0.010" (0.254mm) PER SIDE

S14 1298

## TYPICAL APPLICATION

### 16-Bit Voltage Output DAC on $\pm 5V$ Supply

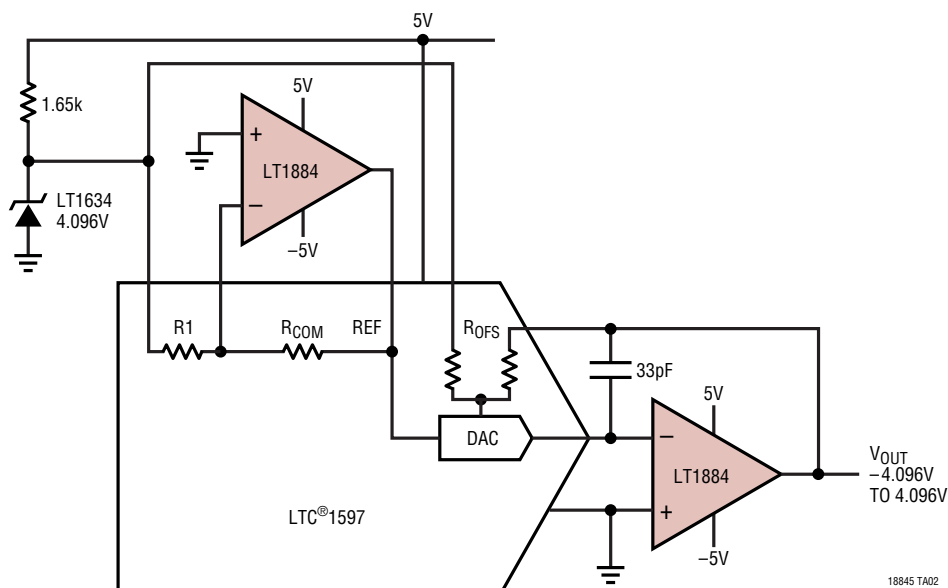

## RELATED PARTS

| PART NUMBER   | DESCRIPTION                                     | COMMENTS                                     |
|---------------|-------------------------------------------------|----------------------------------------------|
| LT1112        | Dual Picoamp Input Op Amp                       | $V_{OS} = 60\mu V$ Max                       |
| LT1114        | Quad Picoamp Input Op Amp                       | $V_{OS} = 60\mu V$ Max                       |
| LT1167        | Gain Programmable Instrumentation Amp           | Gain Error = 0.08% Max                       |
| LT1490        | Micropower Rail-to-Rail Input and Output Op Amp | Over-The-Top™ Common Mode Range              |
| LT1793        | Low Noise JFET Op Amp                           | $I_B = 10pA$ Max                             |
| LT1881/LT1882 | Picoamp Input Rail-to-Rail Output Op Amp        | Lower Input Bias Currents Than LT1884/LT1885 |
| LTC2050       | Zero Drift Op Amp in SOT-23                     | $V_{OS} = 3\mu V$ Max, Rail-to-Rail Output   |

Over-The-Top is a trademark of Linear Technology Corporation.

## Looking for pricing, stock, or lifecycle information?

Click below to explore more details on WIN SOURCE:

 [View LT1884CS8#PBF on WIN SOURCE](#)

 [Linear Technology](#) Information

## Optimize Your Supply Chain with WIN SOURCE Solutions

-  Global Sourcing Solution
-  Obsolete Management
-  Cost Control Management
-  Shortage Management
-  Alternative Solution
-  Excess Inventory Management