



**THE DATASHEET OF
LQY33PN100M02L**



Chip Coils for DC-DC Converter Wire Wound Type

LQY33P Series (1212 Size)

Dimension

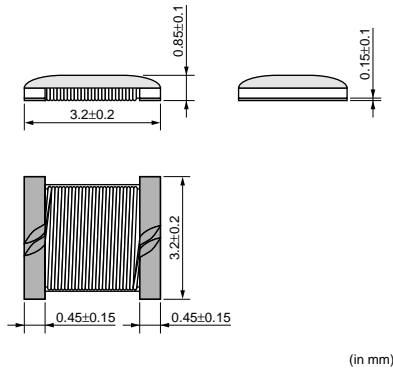

Packaging

Code	Packaging	Minimum Quantity
L	180mm Embossed Tape	1500

Rated Value (□: packaging code)

Part Number	Inductance	Test Frequency	Rated Current	DC resistance	Self Resonance Frequency (min.)
LQY33PN2R2M02□	2.2μH±20%	1MHz	720mA	0.36ohm±30%	270MHz
LQY33PN4R7M02□	4.7μH±20%	1MHz	600mA	0.53ohm±30%	160MHz
LQY33PN100M02□	10μH±20%	1MHz	420mA	1.00ohm±30%	120MHz

Operating Temperature Range: -40°C to +85°C

Only for reflow soldering.

Inductance-Frequency Characteristics

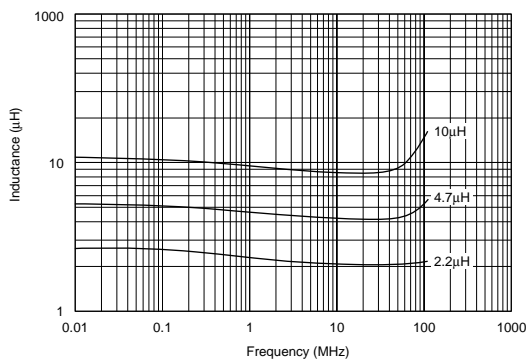

Inductance-Current Characteristics

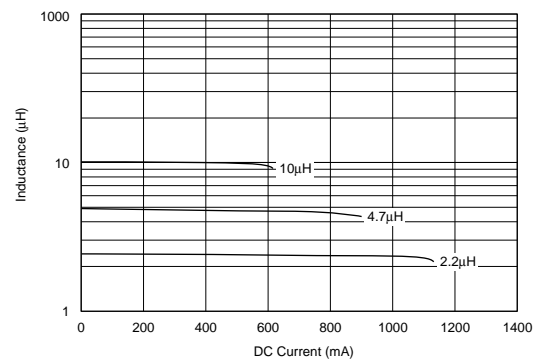

Caution/Notice

Caution (Rating)

Do not use products beyond the rated current as this may create excessive heat.

Notice

Solderability of Tin plating termination chip might be deteriorated when low temperature soldering profile where peak solder temperature is below the Tin melting point is used. Please confirm the solderability of Tin plating termination chip before use.



● This data sheet is applied for CHIP COIL used for General Electronics equipment for your design.

Note:





- This datasheet is downloaded from the website of Murata Manufacturing co., Ltd. Therefore, it's specifications are subject to change or our products in it may be discontinued without advance notice. Please check with our sales representatives or product engineers before ordering.
- This datasheet has only typical specifications because there is no space for detailed specifications. Therefore, please approve our product specifications or transact the approval sheet for product specifications before ordering.

Looking for pricing, stock, or lifecycle information?

Click below to explore more details on WIN SOURCE:

-  [View LQY33PN100M02L on WIN SOURCE](#)
-  [Murata Electronics North America Information](#)

Optimize Your Supply Chain with WIN SOURCE Solutions

-  Global Sourcing Solution
-  Obsolete Management
-  Cost Control Management
-  Shortage Management
-  Alternative Solution
-  Excess Inventory Management