



**THE DATASHEET OF
LQW18AN72NG00D**



Chip Inductors (Chip Coils)





EU RoHS Compliant

- All the products in this catalog comply with EU RoHS.
- EU RoHS is "the European Directive 2011/65/EU on the Restriction of the Use of Certain Hazardous Substances in Electrical and Electronic Equipment."
- For more details, please refer to our web page, "Murata's Approach for EU RoHS" (<https://www.murata.com/en-eu/support/compliance/rohs>).

Contents

Product specifications are as of August 2018.

Product Guide p2

Inductors for Power Lines

Part Numbering p8
Product Detail p10
⚠Caution/Notice p136
Soldering and Mounting p138
Packaging p146

Inductors for General Circuits

Part Numbering p154
Product Detail p155
⚠Caution/Notice p172
Soldering and Mounting p174
Packaging p178

RF Inductors

Part Numbering p182
Product Detail p183
⚠Caution/Notice p263
Soldering and Mounting p265
Packaging p269

Part Number Quick Reference p271

Please check the MURATA website (<https://www.murata.com/>) if you cannot find a part number in this catalog.

Product Guide

| Series | Structure | Size Code in inch (in mm) | Inductance Range | | Rated Current | |
|-------------|-----------|------------------------------|------------------|-------|---------------|-------|
| | | | Min. | Max. | Min. | Max. |
| DFE18SAN_E0 | p10 | 0603 (1608) | 240nH | 1μH | 2A | 4.2A |
| DFE18SAN_GO | p10 | 0603 (1608) | 240nH | 1μH | 2.1A | 4.9A |
| DFE18SBN_E0 | p11 | 0603 (1608) | 470nH | 1μH | 1.9A | 3.1A |
| DFE201208S | p12 | 0805 (2012) | 470nH | 2.2μH | 1.8A | 4A |
| DFE201210S | p13 | 0805 (2012) | 470nH | 2.2μH | 2.1A | 4.8A |
| DFE201210U | p13 | 0805 (2012) | 240nH | 2.2μH | 2A | 6.5A |
| DFE201610C | p14 | 0806 (2016) | 560nH | 2.2μH | 1.5A | 2.8A |
| DFE201610E | p15 | 0806 (2016) | 240nH | 10μH | 1A | 6.3A |
| DFE201610P | p16 | 0806 (2016) | 240nH | 2.2μH | 2A | 5.4A |
| DFE201610R | p16 | 0806 (2016) | 470nH | 2.2μH | 1.6A | 3A |
| DFE201612C | p17 | 0806 (2016) | 470nH | 2.2μH | 1.6A | 3.4A |
| DFE201612E | p18 | 0806 (2016) | 240nH | 4.7μH | 1.8A | 6.6A |
| DFE201612P | p19 | 0806 (2016) | 240nH | 2.2μH | 2.1A | 6.5A |
| DFE201612R | p19 | 0806 (2016) | 470nH | 2.2μH | 1.7A | 3.5A |
| DFE252007F | p20 | 1008 (2520) | 470nH | 4.7μH | 1.2A | 3.3A |
| DFE252008C | p21 | 1008 (2520) | 470nH | 4.7μH | 1.1A | 3A |
| DFE252008U | p22 | 1008 (2520) | 470nH | 10μH | 1A | 4.5A |
| DFE252010C | p22 | 1008 (2520) | 470nH | 10μH | 1A | 3.5A |
| DFE252010F | p23 | 1008 (2520) | 330nH | 10μH | 1.3A | 6.8A |
| DFE252010P | p24 | 1008 (2520) | 330nH | 4.7μH | 1.7A | 5.7A |
| DFE252010R | p25 | 1008 (2520) | 1μH | 4.7μH | 1.4A | 3A |
| DFE252012C | p26 | 1008 (2520) | 470nH | 10μH | 1A | 3.8A |
| DFE252012F | p26 | 1008 (2520) | 330nH | 10μH | 1.4A | 7.6A |
| DFE252012P | p27 | 1008 (2520) | 330nH | 4.7μH | 2A | 6.6A |
| DFE252012R | p28 | 1008 (2520) | 1μH | 4.7μH | 1.7A | 3.4A |
| DFE322510C | p29 | 1210 (3225) | 470nH | 10μH | 1A | 3.8A |
| DFE322512C | p30 | 1210 (3225) | 470nH | 10μH | 1.2A | 4.7A |
| DFE322512F | p30 | 1210 (3225) | 470nH | 10μH | 1.7A | 6.7A |
| FDSD0412 | p31 | 1515 (4040) | 330nH | 4.7μH | 2.5A | 7.5A |
| FDSD0415 | p32 | 1515 (4040) | 220nH | 4.7μH | 2.9A | 12A |
| FDSD0420 | p33 | 1515 (4040) | 330nH | 10μH | 2.5A | 11A |
| FDSD0420W | p34 | 1515 (4040) | 15μH | 22μH | 1.5A | 1.9A |
| FDSD0512 | p34 | 2019 (5249) | 1μH | 6.8μH | 2.3A | 6.1A |
| FDSD0515 | p35 | 2019 (5249) | 1μH | 4.7μH | 3.2A | 7A |
| FDSD0518 | p36 | 2019 (5249) | 680nH | 10μH | 2.7A | 9A |
| FDV0530S | p37 | 2020 (5050) | 120nH | 2.2μH | 4.5A | 18A |
| FDV0530 | p37 | 2423 (6258) | 110nH | 4.7μH | 3.6A | 19.6A |
| FCUL0530 | p38 | 2522 (6357) | 360nH | 470nH | 16A | 18A |
| FDSD0630 | p39 | 2726 (7066) | 680nH | 10μH | 5.4A | 17A |
| FCUL0624 | p40 | 2926 (7366) | 220nH | 470nH | 17A | 24A |
| FCUL0630 | p40 | 2926 (7366) | 120nH | 680nH | 15A | 32A |
| FDV0618 | p41 | 2926 (7467) | 240nH | 3.3μH | 4.1A | 14A |
| FDV0620 | p42 | 2926 (7467) | 200nH | 4.7μH | 3.5A | 16.2A |
| FDVE0630 | p43 | 2926 (7467) | 160nH | 10μH | 3.1A | 20.7A |
| FDVE0640 | p44 | 2926 (7467) | 1.5μH | 4.7μH | 5A | 8.2A |
| FDUE0630 | p44 | 3026 (7667) | 120nH | 240nH | 27A | 36A |
| FDUE0640 | p45 | 3026 (7667) | 150nH | 420nH | 22A | 33A |
| FDUE0650 | p46 | 3026 (7667) | 600nH | 1μH | 16A | 18A |
| FDA1055 | p46 | 4242 (108108) | 560nH | 5.6μH | 8A | 27.7A |
| FDUE1040D | p47 | 4440 (112100) | 220nH | 1μH | 18A | 32A |
| FDVE1040 | p48 | 4440 (112100) | 1.5μH | 10μH | 6.1A | 14.6A |
| FCUL1040 | p49 | 4540 (115100) | 180nH | 420nH | 34A | 53A |
| FCUL1060 | p49 | 4640 (116100) | 360nH | 560nH | 34A | 41A |
| FDUE1245 | p50 | 4848 (123121) | 500nH | 2.2μH | 17A | 30A |

Inductors for Power Lines

Wire Wound
 Metal Alloy
 Core Type

Continued on the following page. ↗

| Series | Structure | Size Code in inch (in mm) | Inductance Range | | Rated Current | |
|--------------------|-------------------------------------|------------------------------|------------------|-------|---------------|-------|
| | | | Min. | Max. | Min. | Max. |
| FDA1254 | Wire Wound Metal Alloy Core Type | 5049 (126125) | 680nH | 8μH | 9.1A | 29.1A |
| FDUE1260 | | 5650 (143127) | 450nH | 450nH | 34A | 34A |
| LQW15DN_00 | Wire Wound Ferrite Core Type | 0402 (1005) | 10μH | 15μH | 100mA | 120mA |
| LQH2MCN_02 | | 0806 (2016) | 1μH | 82μH | 90mA | 485mA |
| LQH2MCN_52 | | 0806 (2016) | 1μH | 22μH | 130mA | 595mA |
| LQH2MPN_GR | | 0806 (2016) | 330nH | 82μH | 210mA | 2.2A |
| LQH2HPN_DR | | 1008 (2520) | 470nH | 22μH | 270mA | 1.67A |
| LQH2HPN_GR | | 1008 (2520) | 470nH | 100μH | 210mA | 2.9A |
| LQH2HPN_JR | | 1008 (2520) | 470nH | 22μH | 540mA | 3.5A |
| LQH31CN_03 | | 1206 (3216) | 120nH | 100μH | 80mA | 970mA |
| LQH32CN_23 | | 1210 (3225) | 1μH | 560μH | 60mA | 800mA |
| LQH32CN_33 | | 1210 (3225) | 150nH | 10μH | 450mA | 1.45A |
| LQH32CN_53 | | 1210 (3225) | 1μH | 100μH | 100mA | 1A |
| LQH32DN_23 | | 1210 (3225) | 1μH | 560μH | 60mA | 800mA |
| LQH32DN_53 | | 1210 (3225) | 1μH | 100μH | 100mA | 1A |
| LQH32PB_NO | | 1210 (3225) | 470nH | 120μH | 200mA | 3.4A |
| LQH32PB_NC | | 1210 (3225) | 470nH | 22μH | 650mA | 4.4A |
| LQH32PN_NO | | 1210 (3225) | 470nH | 120μH | 200mA | 3.4A |
| LQH32PN_NC | | 1210 (3225) | 470nH | 22μH | 650mA | 4.4A |
| DEM2812C | | 1211 (3028) | 470nH | 12μH | 760mA | 3.1A |
| DEM2815C | | 1211 (3028) | 470nH | 15μH | 800mA | 3.9A |
| DEM2818C | | 1211 (3028) | 470nH | 12μH | 1A | 4.7A |
| LQH3NPN_GR | | 1212 (3030) | 470nH | 250μH | 140mA | 2.82A |
| LQH3NPN_JR | | 1212 (3030) | 680nH | 47μH | 570mA | 2.86A |
| LQH3NPN_ME | | 1212 (3030) | 1μH | 100μH | 430mA | 3A |
| DEM3512C | | 1514 (3735) | 680nH | 22μH | 530mA | 2.5A |
| DEM3518C | | 1514 (3735) | 560nH | 22μH | 880mA | 3.4A |
| LQH44PN_GR | | 1515 (4040) | 680nH | 47μH | 410mA | 2.5A |
| LQH44PN_JO | | 1515 (4040) | 1μH | 47μH | 380mA | 2A |
| LQH44PN_PO | | 1515 (4040) | 1μH | 22μH | 800mA | 2.95A |
| LQH43CN_03 | | 1812 (4532) | 1μH | 470μH | 90mA | 1.08A |
| LQH43CN_33 | | 1812 (4532) | 560nH | 3.9μH | 1.6A | 2.95A |
| LQH43PB_26 | | 1812 (4532) | 1μH | 220μH | 240mA | 3.4A |
| LQH43PN_26 | | 1812 (4532) | 1μH | 220μH | 240mA | 3.4A |
| DEM4518C | 1818 (4745) | 1.2μH | 22μH | 1A | 3.5A | |
| LQH5BPB_TO | 2020 (5050) | 470nH | 22μH | 1.4A | 7.7A | |
| LQH5BPN_38 | 2020 (5050) | 1μH | 150μH | 650mA | 7A | |
| LQH5BPN_TO | 2020 (5050) | 470nH | 22μH | 1.4A | 7.7A | |
| D52LC | 2020 (5252) | 1.2μH | 100μH | 260mA | 2.44A | |
| D53LC High Current | 2020 (5252) | 1.1μH | 100μH | 440mA | 3.87A | |
| D53LC Low Rdc | 2020 (5252) | 4.7μH | 220μH | 330mA | 2.18A | |
| LQH55DN_03 | 2220 (5750) | 120nH | 10mH | 50mA | 6A | |
| D63LCB | 2424 (6060) | 1μH | 150μH | 440mA | 4.52A | |
| DG6028C | 2424 (6060) | 1μH | 22μH | 1.7A | 5.8A | |
| DG6045C | 2424 (6060) | 1μH | 100μH | 900mA | 9.5A | |
| DG6050C | 2424 (6060) | 1.2μH | 100μH | 1.2A | 9.8A | |
| LQH66SN_03 | 2525 (6363) | 270nH | 10mH | 50mA | 6A | |
| DS75LC | 2929 (7373) | 1μH | 470μH | 430mA | 9.2A | |
| DEM8030C | 3131 (8080) | 1.5μH | 47μH | 1.3A | 7.5A | |
| DEM8040C | 3131 (8080) | 1.5μH | 33μH | 2.4A | 10A | |
| DEM8045C | 3131 (8080) | 1.5μH | 47μH | 2.1A | 11.2A | |
| DG8040C | 3131 (8080) | 1μH | 100μH | 1.3A | 10.4A | |
| DEM10050C | 3939 (100100) | 1.5μH | 33μH | 3.5A | 15.3A | |
| DEM10050C_DD | 3939 (100100) | 1.5μH | 33μH | 3.5A | 15.3A | |

Continued on the following page. ↗

| | Series | Structure | Size Code in inch (in mm) | Inductance Range | | Rated Current | | |
|---------------------------|------------|-------------|---------------------------------|------------------|-------|---------------|-------|-------|
| | | | | Min. | Max. | Min. | Max. | |
| Inductors for Power Lines | DS104C2 | p102 | Wire Wound Ferrite Core Type | 4040 (101101) | 1.1μH | 120μH | 970mA | 11.7A |
| | DS106C2 | p103 | | 4040 (101101) | 1.2μH | 330μH | 690mA | 12A |
| | DS126C2 | p104 | | 4949 (125125) | 1.7μH | 680μH | 580mA | 11.8A |
| | LQM18FN_00 | p106 | Multilayer Type | 0603 (1608) | 1μH | 10μH | 50mA | 150mA |
| | LQM18PN_B0 | p106 | | 0603 (1608) | 1.5μH | 1.5μH | 600mA | 600mA |
| | LQM18PN_C0 | p107 | | 0603 (1608) | 470nH | 2.2μH | 700mA | 850mA |
| | LQM18PN_D0 | p108 | | 0603 (1608) | 2.5μH | 2.5μH | 700mA | 700mA |
| | LQM18PN_DH | p108 | | 0603 (1608) | 2.2μH | 2.2μH | 650mA | 650mA |
| | LQM18PN_F0 | p109 | | 0603 (1608) | 1μH | 1μH | 600mA | 600mA |
| | LQM18PN_FH | p110 | | 0603 (1608) | 470nH | 2.2μH | 700mA | 1.4A |
| | LQM18PN_FR | p110 | | 0603 (1608) | 220nH | 4.7μH | 620mA | 1.25A |
| | LQM18PN_GH | p111 | | 0603 (1608) | 1μH | 3.3μH | 1.05A | 1.05A |
| | LQM18PW_CH | p112 | | 0603 (1608) | 1μH | 2.5μH | 750mA | 950mA |
| | LQM21DN_00 | p113 | | 0805 (2012) | 1μH | 47μH | 7mA | 60mA |
| | LQM21FN_00 | p113 | | 0805 (2012) | 1μH | 47μH | 7mA | 220mA |
| | LQM21FN_70 | p114 | | 0805 (2012) | 4.7μH | 10μH | 100mA | 120mA |
| | LQM21FN_80 | p115 | | 0805 (2012) | 4.7μH | 10μH | 100mA | 120mA |
| | LQM21PN_C0 | p115 | | 0805 (2012) | 470nH | 2.2μH | 600mA | 1.1A |
| | LQM21PN_CA | p116 | | 0805 (2012) | 2.2μH | 2.2μH | 1.05A | 1.05A |
| | LQM21PN_CH | p117 | | 0805 (2012) | 470nH | 2.2μH | 1.05A | 1.6A |
| | LQM21PN_EH | p118 | | 0805 (2012) | 240nH | 2.2μH | 1.1A | 2.8A |
| | LQM21PN_G0 | p119 | | 0805 (2012) | 470nH | 3.3μH | 800mA | 1.3A |
| | LQM21PN_GC | p120 | | 0805 (2012) | 1μH | 2.2μH | 800mA | 900mA |
| | LQM21PN_GH | p121 | 0805 (2012) | 470nH | 4.7μH | 1A | 2.4A | |
| | LQM21PN_GR | p121 | 0805 (2012) | 1μH | 4.7μH | 800mA | 1.3A | |
| | LQM21PN_GS | p122 | 0805 (2012) | 2.2μH | 4.7μH | 750mA | 950mA | |
| | LQM2MPN_DH | p123 | 0806 (2016) | 2.2μH | 2.2μH | 1.27A | 1.27A | |
| | LQM2MPN_EH | p124 | 0806 (2016) | 240nH | 2.2μH | 1.1A | 4.1A | |
| | LQM2MPN_G0 | p124 | 0806 (2016) | 470nH | 4.7μH | 1.1A | 1.6A | |
| | LQM2MPN_GH | p126 | 0806 (2016) | 160nH | 2.2μH | 1.3A | 5A | |
| | LQM2HPN_CH | p126 | 1008 (2520) | 240nH | 2.2μH | 850mA | 2.55A | |
| | LQM2HPN_E0 | p127 | 1008 (2520) | 560nH | 560nH | 1.5A | 1.5A | |
| | LQM2HPN_EH | p128 | 1008 (2520) | 240nH | 2.2μH | 1.3A | 4.5A | |
| | LQM2HPN_G0 | p129 | 1008 (2520) | 470nH | 4.7μH | 1.1A | 1.8A | |
| | LQM2HPN_GC | p130 | 1008 (2520) | 1μH | 4.7μH | 800mA | 1.5A | |
| LQM2HPN_GH | p130 | 1008 (2520) | 240nH | 2.2μH | 1.5A | 5A | | |
| LQM2HPN_GS | p131 | 1008 (2520) | 2.2μH | 4.7μH | 1A | 1.1A | | |
| LQM2HPN_J0 | p132 | 1008 (2520) | 1μH | 3.3μH | 1A | 1.5A | | |
| LQM2HPN_JH | p133 | 1008 (2520) | 470nH | 2.2μH | 1.5A | 3.2A | | |
| LQM31PN_00 | p133 | 1206 (3216) | 470nH | 4.7μH | 700mA | 1.4A | | |
| LQM32PN_G0 | p134 | 1210 (3225) | 1μH | 1μH | 1.8A | 1.8A | | |
| LQM32PN_GC | p135 | 1210 (3225) | 1μH | 1μH | 2.2A | 2.2A | | |
| RF Inductors | LQG15HN_02 | p183 | Multilayer Type | 0402 (1005) | 1nH | 120nH | 150mA | 1A |
| | LQG15HS_02 | p185 | | 0402 (1005) | 1nH | 270nH | 110mA | 1A |
| | LQG18HN_00 | p188 | 0603 (1608) | 1.2nH | 100nH | 350mA | 1.1A | |
| | LQP02HQ_02 | p189 | Film Type | 01005 (0402) | 0.2nH | 56nH | 100mA | 1A |
| | LQP02TN_02 | p193 | | 01005 (0402) | 0.2nH | 39nH | 90mA | 320mA |
| | LQP02TQ_02 | p196 | | 01005 (0402) | 0.2nH | 22nH | 120mA | 990mA |
| | LQP03HQ_02 | p199 | | 0201 (0603) | 0.6nH | 150nH | 80mA | 1.1A |
| | LQP03PN_02 | p203 | | 0201 (0603) | 2.2nH | 4.7nH | 900mA | 1.4A |
| | LQP03TG_02 | p203 | | 0201 (0603) | 0.1nH | 120nH | 80mA | 850mA |
| | LQP03TN_02 | p206 | | 0201 (0603) | 0.6nH | 270nH | 60mA | 850mA |
| | LQP03TQ_02 | p210 | | 0201 (0603) | 0.6nH | 110nH | 70mA | 1A |
| | LQP15MN_02 | p214 | | 0402 (1005) | 1nH | 33nH | 60mA | 400mA |

Continued on the following page. ↗

| | Series | Structure | Size Code in inch (in mm) | Inductance Range | | Rated Current | | |
|--------------------------------|--------------------------------|-------------|---|------------------|---------------------------------|---------------|-------|-------|
| | | | | Min. | Max. | Min. | Max. | |
| RF Inductors | LQP18MN_02 | p215 | Film Type | 0603 (1608) | 1.3nH | 100nH | 50mA | 300mA |
| | LQW03AW_00 | p216 | Wire Wound Non-Magnetic Core Type | 0201 (0603) | 1nH | 15.5nH | 230mA | 900mA |
| | LQW04AN_00 | p218 | | 03015 (0804) | 0.8nH | 33nH | 140mA | 1.8A |
| | LQW04AN_10 | p222 | | 03015 (0804) | 36nH | 56nH | 180mA | 200mA |
| | LQW15AN_00 | p223 | | 0402 (1005) | 1.5nH | 120nH | 110mA | 1A |
| | LQW15AN_10 | p228 | | 0402 (1005) | 1.3nH | 8.4nH | 640mA | 1.2A |
| | LQW15AN_80 | p230 | | 0402 (1005) | 1.3nH | 75nH | 320mA | 3.15A |
| | LQW15AW_80 | p236 | | 0402 (1005) | 51nH | 220nH | 220mA | 480mA |
| | LQW18AN_00 | p237 | | 0603 (1608) | 2.2nH | 470nH | 75mA | 850mA |
| | LQW18AN_10 | p240 | | 0603 (1608) | 2.2nH | 33nH | 550mA | 1.4A |
| | LQW18AN_80 | p241 | | 0603 (1608) | 2.2nH | 390nH | 190mA | 3.2A |
| | LQW18AS_00 | p245 | | 0603 (1608) | 1.6nH | 390nH | 100mA | 700mA |
| | LQW18AS_0C | p247 | | 0603 (1608) | 4.3nH | 390nH | 100mA | 700mA |
| | LQW2BAN_00 | p248 | | 0805 (2015) | 3.2nH | 200nH | 750mA | 3.8A |
| | LQW2BAS_00 | p250 | | 0805 (2015) | 2.7nH | 1μH | 170mA | 910mA |
| | LQW2BHN_03 | p252 | | 0805 (2015) | 3.3nH | 470nH | 160mA | 1.32A |
| | LQW2BHN_13 | p254 | | 0805 (2015) | 2.7nH | 27nH | 900mA | 1.9A |
| | LQW2UAS_00 | p254 | | 1008 (2520) | 12nH | 4.7μH | 260mA | 1A |
| | LQW31HN_03 | p257 | | 1206 (3216) | 8.8nH | 100nH | 230mA | 750mA |
| | Inductors for General Circuits | LQW15CN_00 | | p258 | Wire Wound Ferrite Core Type | 0402 (1005) | 18nH | 200nH |
| LQW15CN_10 | | p258 | 0402 (1005) | 20nH | | 3.3μH | 130mA | 2.2A |
| LQW18CN_00 | | p260 | 0603 (1608) | 4.9nH | | 650nH | 430mA | 2.6A |
| LQW21HN_00 | | p261 | 0805 (2012) | 470nH | | 2.2μH | 75mA | 160mA |
| LQH31HN_03 | | p261 | 1206 (3216) | 54nH | | 880nH | 180mA | 920mA |
| Inductors for General Circuits | LQW04CA_00 | p155 | Wire Wound Ferrite Core Type | 03019 (0805) | 60nH | 510nH | 200mA | 620mA |
| | LQW15CA_00 | p155 | | 0402 (1005) | 22nH | 2μH | 130mA | 1.3A |
| | LQW18CA_00 | p157 | | 0603 (1608) | 32nH | 580nH | 450mA | 2.2A |
| | LQH31MN_03 | p158 | | 1206 (3216) | 150nH | 100μH | 45mA | 250mA |
| | LQH32MN_23 | p160 | | 1210 (3225) | 1μH | 560μH | 40mA | 445mA |
| | LQH44NN_03 | p162 | | 1515 (4040) | 510nH | 470μH | 145mA | 4.5A |
| | LQH43MN_03 | p163 | | 1812 (4532) | 1μH | 1.5mH | 40mA | 500mA |
| | LQH43NN_03 | p165 | | 1812 (4532) | 1μH | 2.4mH | 25mA | 500mA |
| | LQB15NN_10 | p167 | Multilayer Type | 0402 (1005) | 220nH | 560nH | 300mA | 380mA |
| | LQB18NN_10 | p168 | | 0603 (1608) | 220nH | 560nH | 300mA | 450mA |
| LQM18JN_00 | p169 | 0603 (1608) | | 100nH | 160nH | 550mA | 650mA | |
| LQM18NN_00 | p169 | 0603 (1608) | | 47nH | 2.2μH | 15mA | 50mA | |
| LQM21NN_10 | p170 | 0805 (2012) | 100nH | 4.7μH | 30mA | 250mA | | |

Inductors for Power Lines

| | |
|------------------------------|------|
| Part Numbering | p8 |
| Product Detail | p10 |
| ⚠Caution/Notice | p136 |
| Soldering and Mounting | p138 |
| Packaging | p146 |

● Part Numbering

Inductors for Power Lines



① Product ID

| Product ID | |
|------------|-----------------------------|
| LQ | Chip Inductors (Chip Coils) |

② Structure

| Code | Structure |
|------|--------------------------------|
| H | Wire Wound Type (Ferrite Core) |
| M | Multilayer Type (Ferrite Core) |
| W | Wire Wound Type (Ferrite Core) |

③ Dimensions (LxW)

| Code | Nominal Dimensions (LxW) | Size Code (in inch) |
|------|--------------------------|---------------------|
| 15 | 1.0x0.5mm | 0402 |
| 18 | 1.6x0.8mm | 0603 |
| 21 | 2.0x1.25mm | 0805 |
| 2M | 2.0x1.6mm | 0806 |
| 2H | 2.5x2.0mm | 1008 |
| 3N | 3.0x3.0mm | 1212 |
| 31 | 3.2x1.6mm | 1206 |
| 32 | 3.2x2.5mm | 1210 |
| 43 | 4.5x3.2mm | 1812 |
| 44 | 4.0x4.0mm | 1515 |
| 5B | 5.0x5.0mm | 2020 |
| 55 | 5.7x5.0mm | 2220 |
| 66 | 6.3x6.3mm | 2525 |

④ Applications and Characteristics

| Code | Series | Applications and Characteristics |
|------|---------|---|
| D | LQM | for Choke (Low-current DC Power Supplies) |
| F | | for Choke (DC Power Supplies) |
| D | LQH | for Choke |
| S | | for Choke (Magnetically Shielded Type) |
| C | | for Choke (Coating Type) |
| P | LQM/LQH | for Power Line |
| D | LQW | |

⑤ Category

| Code | Category |
|------|--------------------------------|
| N | Standard Type |
| B | Special Feature Classification |
| W | |

⑥ Inductance

Expressed by three-digit alphanumeric. The unit is micro-henry (μH). The first and second figures are significant digits, and the third figure expresses the number of zeros that follow the two figures. If there is a decimal point, it is expressed by the capital letter "R." In this case, all figures are significant digits. If inductance is less than $0.1\mu\text{H}$, the inductance code is expressed by a combination of two figures and the capital letter "N," and the unit of inductance is nano-henry (nH). The capital letter "N" indicates the unit of "nH," and also expresses a decimal point. In this case, all figures are significant digits. For those products whose inductance values are specified using three designated digits, these values may be indicated using the closest two digits instead.

⑦ Inductance Tolerance

| Code | Inductance Tolerance |
|------|----------------------|
| K | $\pm 10\%$ |
| M | $\pm 20\%$ |
| N | $\pm 30\%$ |

⑧ Features (Except for LQH□□P/LQM□□P)

| Code | Features | Series |
|------|---------------------------------------|----------------|
| 0 | Standard Type | LQM/LQH/LQW |
| 2 | Standard Type | LQH32C/32D |
| 3 | Low DC Resistance | LQH32C/43CN |
| 5 | Low Profile Type | LQH2MC/32C/32D |
| 7 | Large Current Type | LQM21F |
| 8 | Low DC Resistance /Large Current Type | |

⑨ Thickness

(LQH□□P/LQM□□P Only • Except for LQH43P/LQH5BPN_38)

| Code | Nominal Dimensions (T) |
|------|------------------------|
| B | 0.35mm |
| C | 0.5mm |
| D | 0.6mm |
| E | 0.7mm |
| F | 0.8mm |
| O | 0.85mm |
| G | 0.9mm |
| J | 1.1mm |
| M | 1.4mm |
| N | 1.55mm |
| P | 1.65mm |
| T | 2.0mm |

Continued on the following page. ↗

Continued from the preceding page. ↘

⑨ Electrode (Except for LQH□□P/LQM□□P)

•Lead (Pb) Free

| Code | Electrode | Series |
|------|-----------|-------------------------|
| 0 | Sn | LQM/LQW |
| 2 | | LQH2MC |
| 3 | LF Solder | LQH (Except for LQH2MC) |

⑩ Specification

(LQH□□P/LQM□□P Only • Except for LQH43P/LQH5BPN_38)

| Code | Specification |
|-------|---|
| 0/S | Standard Type |
| C | Good Bias Current Characteristics Type |
| H/A/E | High Spec Type (Low DC Resistance; Good Bias Current Characteristics Type) |
| R | Low DC Resistance Type |

⑪ Thickness (LQH43P/LQH5BPN_38 Only)

| Code | Dimensions (T) |
|------|----------------|
| 26 | 2.6mm |
| 38 | 4.0mm max. |

⑫ Packaging

| Code | Packaging |
|------|-------------------------------|
| K | Embossed Taping (ø330mm Reel) |
| F | |
| L | Embossed Taping (ø180mm Reel) |
| E | |
| B | Bulk |
| J | Paper Taping (ø330mm Reel) |
| D | Paper Taping (ø180mm Reel) |

Inductors for Power Lines

DFE18SAN_E0 Series 0603 (1608) inch (mm)



| Packaging Code | Packaging | Minimum Quantity |
|----------------|------------------------|------------------|
| L | ø180mm Embossed Taping | 3000 |

| Part Number (□: packaging code) | Inductance | Inductance Test Frequency | Rated Current (Isat)* | Rated Current (Itemp)* | Max. of DC Resistance |
|------------------------------------|-------------|---------------------------|-----------------------|------------------------|-----------------------|
| DFE18SANR24ME0□ | 0.24μH ±20% | 1MHz | 4200mA | 3200mA | 0.036Ω |
| DFE18SANR47ME0□ | 0.47μH ±20% | 1MHz | 3100mA | 2400mA | 0.064Ω |
| DFE18SANR56ME0□ | 0.56μH ±20% | 1MHz | 2600mA | 2200mA | 0.070Ω |
| DFE18SAN1R0ME0□ | 1.0μH ±20% | 1MHz | 2000mA | 1600mA | 0.144Ω |

Absolute maximum voltage: 20V DC

Operating temp. range (Self-temp. rise included): -40 to 125°C

Operating temp. range (Self-temp. rise not included): -40 to 85°C

Class of Magnetic Shield: Metal Alloy

Only for reflow soldering

*Isat: Rated Current based on Inductance change

*Itemp: Rated Current based on Temperature rise

The saturation allowable DC current value is specified when the decrease of the initial inductance value at 30%. When rated current is applied to the products, the temperature rise caused by self-generated heat shall be limited to 40°C max. Keep the temperature (ambient temperature plus self-generation of heat) under 125°C.

Inductance-Frequency Characteristics (Typ.)



Inductance-Current Characteristics (Typ.)



Temperature Rise Characteristics (Typ.)



DFE18SAN_G0 Series 0603 (1608) inch (mm)



| Packaging Code | Packaging | Minimum Quantity |
|----------------|------------------------|------------------|
| L | ø180mm Embossed Taping | 3000 |

Continued on the following page. ↗

Continued from the preceding page. ↘

| Part Number (□: packaging code) | Inductance | Inductance Test Frequency | Rated Current (Isat)* | Rated Current (Itemp)* | Max. of DC Resistance |
|------------------------------------|-------------|------------------------------|-----------------------|------------------------|-----------------------|
| DFE18SANR24MG0□ | 0.24μH ±20% | 1MHz | 4900mA | 3500mA | 0.030Ω |
| DFE18SANR47MG0□ | 0.47μH ±20% | 1MHz | 3300mA | 2600mA | 0.054Ω |
| DFE18SAN1ROMG0□ | 1.0μH ±20% | 1MHz | 2100mA | 1700mA | 0.128Ω |

Absolute maximum voltage: 20V DC

Operating temp. range (Self-temp. rise included): -40 to 125°C

Operating temp. range (Self-temp. rise not included): -40 to 85°C

Class of Magnetic Shield: Metal Alloy

Only for reflow soldering

*Isat: Rated Current based on Inductance change

*Itemp: Rated Current based on Temperature rise

The saturation allowable DC current value is specified when the decrease of the initial inductance value at 30%. When rated current is applied to the products, the temperature rise caused by self-generated heat shall be limited to 40°C max. Keep the temperature (ambient temperature plus self-generation of heat) under 125°C.

Inductance-Frequency Characteristics (Typ.)



Inductance-Current Characteristics (Typ.)



Temperature Rise Characteristics (Typ.)



DFE18SBN_E0 Series 0603 (1608) inch (mm)



| Packaging Code | Packaging | Minimum Quantity |
|----------------|------------------------|------------------|
| L | ø180mm Embossed Taping | 3000 |

| Part Number (□: packaging code) | Inductance | Inductance Test Frequency | Rated Current (Isat)* | Rated Current (Itemp)* | Max. of DC Resistance |
|------------------------------------|-------------|------------------------------|-----------------------|------------------------|-----------------------|
| DFE18SBNR47ME0□ | 0.47μH ±20% | 1MHz | 3100mA | 2400mA | 0.06Ω |
| DFE18SBN1ROME0□ | 1.0μH ±20% | 1MHz | 1900mA | 1800mA | 0.12Ω |

Absolute maximum voltage: 20V DC

Operating temp. range (Self-temp. rise included): -40 to 125°C

Operating temp. range (Self-temp. rise not included): -40 to 85°C

Class of Magnetic Shield: Metal Alloy

Only for reflow soldering

*Isat: Rated Current based on Inductance change

*Itemp: Rated Current based on Temperature rise

The saturation allowable DC current value is specified when the decrease of the initial inductance value at 30%. When rated current is applied to the products, the temperature rise caused by self-generated heat shall be limited to 40°C max. Keep the temperature (ambient temperature plus self-generation of heat) under 125°C.

Continued on the following page. ↗

Continued from the preceding page. ↘

Inductance-Frequency Characteristics (Typ.)



Inductance-Current Characteristics (Typ.)



Temperature Rise Characteristics (Typ.)



DFE201208S Series 0805 (2012) inch (mm)



(in mm)

| Packaging Code | Packaging | Minimum Quantity |
|----------------|------------------------|------------------|
| =P2 | ø180mm Embossed Taping | 3000 |

| Part Number (□: packaging code) | Inductance | Inductance Test Frequency | Rated Current (Isat)* | Rated Current (Itemp)* | Max. of DC Resistance |
|------------------------------------|-------------|---------------------------|-----------------------|------------------------|-----------------------|
| DFE201208S-R47M□ | 0.47μH ±20% | 1MHz | 4000mA | 3000mA | 0.042Ω |
| DFE201208S-1R0M□ | 1.0μH ±20% | 1MHz | 2700mA | 2100mA | 0.084Ω |
| DFE201208S-1R5M□ | 1.5μH ±20% | 1MHz | 2300mA | 1800mA | 0.120Ω |
| DFE201208S-2R2M□ | 2.2μH ±20% | 1MHz | 1800mA | 1400mA | 0.204Ω |

Absolute maximum voltage: 20V DC

Operating temp. range (Self-temp. rise included): -40 to 125°C

Class of Magnetic Shield: Metal Alloy

Only for reflow soldering

*Isat: Rated Current based on Inductance change

*Itemp: Rated Current based on Temperature rise

Rated current (Isat) is specified when the decrease of the initial inductance value at 30%. Rated current (Itemp) is specified when temperature of the inductor is raised 40°C by DC current.

Inductance-Frequency Characteristics (Typ.)



Inductance-Current Characteristics (Typ.)



Temperature Rise Characteristics (Typ.)



Inductors for Power Lines DFE201208S
 Inductors for General Circuits
 RF Inductors

DFE201210S Series 0805 (2012) inch (mm)



(in mm)

| Packaging Code | Packaging | Minimum Quantity |
|----------------|------------------------|------------------|
| =P2 | ø180mm Embossed Taping | 3000 |

| Part Number (□: packaging code) | Inductance | Inductance Test Frequency | Rated Current (Isat)* | Rated Current (Itemp)* | Max. of DC Resistance |
|------------------------------------|-------------|---------------------------|-----------------------|------------------------|-----------------------|
| DFE201210S-R47M□ | 0.47μH ±20% | 1MHz | 4800mA | 3400mA | 0.032Ω |
| DFE201210S-1R0M□ | 1.0μH ±20% | 1MHz | 3200mA | 2300mA | 0.070Ω |
| DFE201210S-1R5M□ | 1.5μH ±20% | 1MHz | 2700mA | 2000mA | 0.096Ω |
| DFE201210S-2R2M□ | 2.2μH ±20% | 1MHz | 2100mA | 1500mA | 0.155Ω |

Absolute maximum voltage: 20V DC

Operating temp. range (Self-temp. rise included): -40 to 125°C

Class of Magnetic Shield: Metal Alloy

Only for reflow soldering

*Isat: Rated Current based on Inductance change

*Itemp: Rated Current based on Temperature rise

Rated current (Isat) is specified when the decrease of the initial inductance value at 30%. Rated current (Itemp) is specified when temperature of the inductor is raised 40°C by DC current.

Inductance-Frequency Characteristics (Typ.)



Inductance-Current Characteristics (Typ.)



Temperature Rise Characteristics (Typ.)



DFE201210U Series 0805 (2012) inch (mm)



(in mm)

| Packaging Code | Packaging | Minimum Quantity |
|----------------|------------------------|------------------|
| =P2 | ø180mm Embossed Taping | 3000 |

Continued on the following page. ↗

DFE201210S
Inductors for Power Lines

Inductors for General Circuits

RF Inductors

Continued from the preceding page. ↘

| Part Number (□: packaging code) | Inductance | Inductance Test Frequency | Rated Current (Isat)* | Rated Current (Itemp)* | Max. of DC Resistance |
|------------------------------------|-------------|------------------------------|-----------------------|------------------------|-----------------------|
| DFE201210U-R24M□ | 0.24μH ±20% | 1MHz | 6500mA | 3800mA | 0.025Ω |
| DFE201210U-R33M□ | 0.33μH ±20% | 1MHz | 5200mA | 3400mA | 0.031Ω |
| DFE201210U-R47M□ | 0.47μH ±20% | 1MHz | 4400mA | 3000mA | 0.042Ω |
| DFE201210U-R68M□ | 0.68μH ±20% | 1MHz | 3600mA | 2400mA | 0.060Ω |
| DFE201210U-1R0M□ | 1.0μH ±20% | 1MHz | 3100mA | 2000mA | 0.095Ω |
| DFE201210U-1R5M□ | 1.5μH ±20% | 1MHz | 2500mA | 1600mA | 0.138Ω |
| DFE201210U-2R2M□ | 2.2μH ±20% | 1MHz | 2000mA | 1200mA | 0.228Ω |

Absolute maximum voltage: 20V DC

Operating temp. range (Self-temp. rise included): -40 to 125°C

Class of Magnetic Shield: Metal Alloy

Only for reflow soldering

*Isat: Rated Current based on Inductance change

*Itemp: Rated Current based on Temperature rise

Rated current (Isat) is specified when the decrease of the initial inductance value at 30%. Rated current (Itemp) is specified when temperature of the inductor is raised 40°C by DC current.

Inductance-Frequency Characteristics (Typ.)



Inductance-Current Characteristics (Typ.)



Temperature Rise Characteristics (Typ.)



DFE201610C Series 0806 (2016) inch (mm)



(in mm)

| Packaging Code | Packaging | Minimum Quantity |
|----------------|------------------------|------------------|
| =P2 | ø180mm Embossed Taping | 3000 |

| Part Number (□: packaging code) | Inductance | Inductance Test Frequency | Rated Current (Isat)* | Rated Current (Itemp)* | Max. of DC Resistance |
|------------------------------------|-------------|------------------------------|-----------------------|------------------------|-----------------------|
| 1285AS-H-R56M□ | 0.56μH ±20% | 1MHz | 2800mA | 2800mA | 0.059Ω |
| 1285AS-H-R68M□ | 0.68μH ±20% | 1MHz | 2600mA | 2500mA | 0.072Ω |
| 1285AS-H-1R0M□ | 1.0μH ±20% | 1MHz | 2200mA | 2000mA | 0.096Ω |
| 1285AS-H-1R5M□ | 1.5μH ±20% | 1MHz | 1800mA | 1600mA | 0.144Ω |
| 1285AS-H-2R2M□ | 2.2μH ±20% | 1MHz | 1500mA | 1200mA | 0.204Ω |

Absolute maximum voltage: 20V DC

Operating temp. range (Self-temp. rise included): -40 to 85°C

Class of Magnetic Shield: Metal Alloy

Only for reflow soldering

*Isat: Rated Current based on Inductance change

*Itemp: Rated Current based on Temperature rise

Rated current (Isat) is specified when the decrease of the initial inductance value at 30%. Rated current (Itemp) is specified when temperature of the inductor is raised 40°C by DC current.

Continued on the following page. ↗

Continued from the preceding page. ↘

Inductance-Frequency Characteristics (Typ.)



Inductance-Current Characteristics (Typ.)



Temperature Rise Characteristics (Typ.)



DFE201610E Series 0806 (2016) inch (mm)



| Packaging Code | Packaging | Minimum Quantity |
|----------------|------------------------|------------------|
| =P2 | ø180mm Embossed Taping | 3000 |

| Part Number (□: packaging code) | Inductance | Inductance Test Frequency | Rated Current (Isat)* | Rated Current (Itemp)* | Max. of DC Resistance |
|------------------------------------|-------------|---------------------------|-----------------------|------------------------|-----------------------|
| DFE201610E-R24M□ | 0.24µH ±20% | 1MHz | 6300mA | 4700mA | 0.020Ω |
| DFE201610E-R33M□ | 0.33µH ±20% | 1MHz | 5500mA | 4000mA | 0.026Ω |
| DFE201610E-R47M□ | 0.47µH ±20% | 1MHz | 4800mA | 3600mA | 0.032Ω |
| DFE201610E-R68M□ | 0.68µH ±20% | 1MHz | 4300mA | 3100mA | 0.043Ω |
| DFE201610E-1R0M□ | 1.0µH ±20% | 1MHz | 3600mA | 2700mA | 0.057Ω |
| DFE201610E-1R5M□ | 1.5µH ±20% | 1MHz | 2900mA | 2100mA | 0.091Ω |
| DFE201610E-2R2M□ | 2.2µH ±20% | 1MHz | 2400mA | 1700mA | 0.140Ω |
| DFE201610E-4R7M□ | 4.7µH ±20% | 1MHz | 1600mA | 1100mA | 0.288Ω |
| DFE201610E-100M□ | 10µH ±20% | 1MHz | 1000mA | 650mA | 0.780Ω |

Absolute maximum voltage: 20V DC

Operating temp. range (Self-temp. rise included): -40 to 125°C

Class of Magnetic Shield: Metal Alloy

Only for reflow soldering

*Isat: Rated Current based on Inductance change

*Itemp: Rated Current based on Temperature rise

Rated current (Isat) is specified when the decrease of the initial inductance value at 30%. Rated current (Itemp) is specified when temperature of the inductor is raised 40°C by DC current.

Inductance-Frequency Characteristics (Typ.)



Inductance-Current Characteristics (Typ.)



Temperature Rise Characteristics (Typ.)



DFE201610P Series 0806 (2016) inch (mm)



| Packaging Code | Packaging | Minimum Quantity |
|----------------|------------------------|------------------|
| =P2 | ø180mm Embossed Taping | 3000 |

| Part Number (□: packaging code) | Inductance | Inductance Test Frequency | Rated Current (Isat)* | Rated Current (Itemp)* | Max. of DC Resistance |
|------------------------------------|-------------|---------------------------|-----------------------|------------------------|-----------------------|
| DFE201610P-R24M□ | 0.24μH ±20% | 1MHz | 5400mA | 3800mA | 0.026Ω |
| DFE201610P-R33M□ | 0.33μH ±20% | 1MHz | 4700mA | 3500mA | 0.034Ω |
| DFE201610P-R47M□ | 0.47μH ±20% | 1MHz | 4000mA | 3100mA | 0.040Ω |
| DFE201610P-R68M□ | 0.68μH ±20% | 1MHz | 3600mA | 2700mA | 0.048Ω |
| DFE201610P-1R0M□ | 1.0μH ±20% | 1MHz | 3100mA | 2200mA | 0.070Ω |
| DFE201610P-1R5M□ | 1.5μH ±20% | 1MHz | 2500mA | 1800mA | 0.110Ω |
| DFE201610P-2R2M□ | 2.2μH ±20% | 1MHz | 2000mA | 1400mA | 0.168Ω |

Absolute maximum voltage: 20V DC

Operating temp. range (Self-temp. rise included): -40 to 125°C

Class of Magnetic Shield: Metal Alloy

Only for reflow soldering

*Isat: Rated Current based on Inductance change

*Itemp: Rated Current based on Temperature rise

Rated current (Isat) is specified when the decrease of the initial inductance value at 30%. Rated current (Itemp) is specified when temperature of the inductor is raised 40°C by DC current.

Inductance-Frequency Characteristics (Typ.)



Inductance-Current Characteristics (Typ.)



Temperature Rise Characteristics (Typ.)



DFE201610R Series 0806 (2016) inch (mm)



| Packaging Code | Packaging | Minimum Quantity |
|----------------|------------------------|------------------|
| =P2 | ø180mm Embossed Taping | 3000 |

Continued on the following page. ↗

Continued from the preceding page. ↘

| Part Number (□: packaging code) | Inductance | Inductance Test Frequency | Rated Current (Isat)* | Rated Current (Itemp)* | Max. of DC Resistance |
|------------------------------------|-------------|------------------------------|-----------------------|------------------------|-----------------------|
| DFE201610R-H-R47M□ | 0.47μH ±20% | 1MHz | 3000mA | 2800mA | 0.048Ω |
| DFE201610R-H-1R0M□ | 1.0μH ±20% | 1MHz | 2200mA | 2100mA | 0.079Ω |
| DFE201610R-H-1R5M□ | 1.5μH ±20% | 1MHz | 1800mA | 1800mA | 0.118Ω |
| DFE201610R-H-2R2M□ | 2.2μH ±20% | 1MHz | 1600mA | 1400mA | 0.168Ω |

Absolute maximum voltage: 20V DC

Operating temp. range (Self-temp. rise included): -40 to 85°C

Class of Magnetic Shield: Metal Alloy

Only for reflow soldering

*Isat: Rated Current based on Inductance change

*Itemp: Rated Current based on Temperature rise

Rated current (Isat) is specified when the decrease of the initial inductance value at 30%. Rated current (Itemp) is specified when temperature of the inductor is raised 40°C by DC current.

Inductance-Frequency Characteristics (Typ.)



Inductance-Current Characteristics (Typ.)



Temperature Rise Characteristics (Typ.)



DFE201612C Series 0806 (2016) inch (mm)



| Packaging Code | Packaging | Minimum Quantity |
|----------------|------------------------|------------------|
| =P2 | ø180mm Embossed Taping | 3000 |

| Part Number (□: packaging code) | Inductance | Inductance Test Frequency | Rated Current (Isat)* | Rated Current (Itemp)* | Max. of DC Resistance |
|------------------------------------|-------------|------------------------------|-----------------------|------------------------|-----------------------|
| 1286AS-H-R47M□ | 0.47μH ±20% | 1MHz | 3400mA | 3200mA | 0.052Ω |
| 1286AS-H-1R0M□ | 1.0μH ±20% | 1MHz | 2500mA | 2300mA | 0.082Ω |
| 1286AS-H-1R5M□ | 1.5μH ±20% | 1MHz | 2000mA | 1800mA | 0.114Ω |
| 1286AS-H-2R2M□ | 2.2μH ±20% | 1MHz | 1600mA | 1300mA | 0.192Ω |

Absolute maximum voltage: 20V DC

Operating temp. range (Self-temp. rise included): -40 to 85°C

Class of Magnetic Shield: Metal Alloy

Only for reflow soldering

*Isat: Rated Current based on Inductance change

*Itemp: Rated Current based on Temperature rise

Rated current (Isat) is specified when the decrease of the initial inductance value at 30%. Rated current (Itemp) is specified when temperature of the inductor is raised 40°C by DC current.

Continued on the following page. ↗

DFE201612C
Inductors for Power Lines

Inductors for General Circuits

RF Inductors

Continued from the preceding page. ↘

Inductance-Frequency Characteristics (Typ.)



Inductance-Current Characteristics (Typ.)



Temperature Rise Characteristics (Typ.)



DFE201612E Series 0806 (2016) inch (mm)



(in mm)

| Packaging Code | Packaging | Minimum Quantity |
|----------------|------------------------|------------------|
| =P2 | ø180mm Embossed Taping | 3000 |

| Part Number (□: packaging code) | Inductance | Inductance Test Frequency | Rated Current (Isat)* | Rated Current (Itemp)* | Max. of DC Resistance |
|------------------------------------|-------------|---------------------------|-----------------------|------------------------|-----------------------|
| DFE201612E-R24M□ | 0.24µH ±20% | 1MHz | 6600mA | 5000mA | 0.019Ω |
| DFE201612E-R33M□ | 0.33µH ±20% | 1MHz | 6300mA | 4800mA | 0.021Ω |
| DFE201612E-R47M□ | 0.47µH ±20% | 1MHz | 5500mA | 4500mA | 0.026Ω |
| DFE201612E-R68M□ | 0.68µH ±20% | 1MHz | 4300mA | 3500mA | 0.033Ω |
| DFE201612E-1R0M□ | 1.0µH ±20% | 1MHz | 4000mA | 2900mA | 0.048Ω |
| DFE201612E-1R5M□ | 1.5µH ±20% | 1MHz | 3200mA | 2300mA | 0.072Ω |
| DFE201612E-2R2M□ | 2.2µH ±20% | 1MHz | 2400mA | 1800mA | 0.116Ω |
| DFE201612E-4R7M□ | 4.7µH ±20% | 1MHz | 1800mA | 1200mA | 0.252Ω |

Absolute maximum voltage: 20V DC

Operating temp. range (Self-temp. rise included): -40 to 125°C

Class of Magnetic Shield: Metal Alloy

Only for reflow soldering

*Isat: Rated Current based on Inductance change

*Itemp: Rated Current based on Temperature rise

Rated current (Isat) is specified when the decrease of the initial inductance value at 30%. Rated current (Itemp) is specified when temperature of the inductor is raised 40°C by DC current.

Inductance-Frequency Characteristics (Typ.)



Inductance-Current Characteristics (Typ.)



Temperature Rise Characteristics (Typ.)



DFE201612P Series 0806 (2016) inch (mm)



| Packaging Code | Packaging | Minimum Quantity |
|----------------|------------------------|------------------|
| =P2 | ø180mm Embossed Taping | 3000 |

| Part Number (□: packaging code) | Inductance | Inductance Test Frequency | Rated Current (Isat)* | Rated Current (Itemp)* | Max. of DC Resistance |
|------------------------------------|-------------|---------------------------|-----------------------|------------------------|-----------------------|
| DFE201612P-R24M□ | 0.24μH ±20% | 1MHz | 6500mA | 4400mA | 0.023Ω |
| DFE201612P-R33M□ | 0.33μH ±20% | 1MHz | 5600mA | 3900mA | 0.028Ω |
| DFE201612P-R47M□ | 0.47μH ±20% | 1MHz | 4800mA | 3700mA | 0.033Ω |
| DFE201612P-1R0M□ | 1.0μH ±20% | 1MHz | 3300mA | 2700mA | 0.054Ω |
| DFE201612P-1R5M□ | 1.5μH ±20% | 1MHz | 2700mA | 2000mA | 0.095Ω |
| DFE201612P-2R2M□ | 2.2μH ±20% | 1MHz | 2100mA | 1500mA | 0.144Ω |

Absolute maximum voltage: 20V DC

Operating temp. range (Self-temp. rise included): -40 to 125°C

Class of Magnetic Shield: Metal Alloy

Only for reflow soldering

*Isat: Rated Current based on Inductance change

*Itemp: Rated Current based on Temperature rise

Rated current (Isat) is specified when the decrease of the initial inductance value at 30%. Rated current (Itemp) is specified when temperature of the inductor is raised 40°C by DC current.

Inductance-Frequency Characteristics (Typ.)



Inductance-Current Characteristics (Typ.)



Temperature Rise Characteristics (Typ.)



DFE201612R Series 0806 (2016) inch (mm)



| Packaging Code | Packaging | Minimum Quantity |
|----------------|------------------------|------------------|
| =P2 | ø180mm Embossed Taping | 3000 |

Continued on the following page. ↗

Continued from the preceding page. ↘

| Part Number (□: packaging code) | Inductance | Inductance Test Frequency | Rated Current (Isat)* | Rated Current (Itemp)* | Max. of DC Resistance |
|------------------------------------|-------------|------------------------------|-----------------------|------------------------|-----------------------|
| DFE201612R-H-R47M□ | 0.47μH ±20% | 1MHz | 3500mA | 3200mA | 0.040Ω |
| DFE201612R-H-1R0M□ | 1.0μH ±20% | 1MHz | 2600mA | 2600mA | 0.070Ω |
| DFE201612R-H-1R5M□ | 1.5μH ±20% | 1MHz | 2100mA | 2000mA | 0.094Ω |
| DFE201612R-H-2R2M□ | 2.2μH ±20% | 1MHz | 1700mA | 1400mA | 0.154Ω |

Absolute maximum voltage: 20V DC

Operating temp. range (Self-temp. rise included): -40 to 85°C

Class of Magnetic Shield: Metal Alloy

Only for reflow soldering

*Isat: Rated Current based on Inductance change

*Itemp: Rated Current based on Temperature rise

Rated current (Isat) is specified when the decrease of the initial inductance value at 30%. Rated current (Itemp) is specified when temperature of the inductor is raised 40°C by DC current.

Inductance-Frequency Characteristics (Typ.)



Inductance-Current Characteristics (Typ.)



Temperature Rise Characteristics (Typ.)



DFE252007F Series 1008 (2520) inch (mm)



(in mm)

| Packaging Code | Packaging | Minimum Quantity |
|----------------|------------------------|------------------|
| =P2 | ø180mm Embossed Taping | 3000 |

| Part Number (□: packaging code) | Inductance | Inductance Test Frequency | Rated Current (Isat)* | Rated Current (Itemp)* | Max. of DC Resistance |
|------------------------------------|-------------|------------------------------|-----------------------|------------------------|-----------------------|
| DFE252007F-R47M□ | 0.47μH ±20% | 1MHz | 3300mA | 2700mA | 0.053Ω |
| DFE252007F-1R0M□ | 1.0μH ±20% | 1MHz | 2800mA | 2100mA | 0.085Ω |
| DFE252007F-1R5M□ | 1.5μH ±20% | 1MHz | 2100mA | 1700mA | 0.132Ω |
| DFE252007F-2R2M□ | 2.2μH ±20% | 1MHz | 1800mA | 1400mA | 0.182Ω |
| DFE252007F-3R3M□ | 3.3μH ±20% | 1MHz | 1500mA | 1200mA | 0.275Ω |
| DFE252007F-4R7M□ | 4.7μH ±20% | 1MHz | 1200mA | 940mA | 0.450Ω |

Absolute maximum voltage: 20V DC

Operating temp. range (Self-temp. rise included): -40 to 125°C

Class of Magnetic Shield: Metal Alloy

Only for reflow soldering

*Isat: Rated Current based on Inductance change

*Itemp: Rated Current based on Temperature rise

Rated current (Isat) is specified when the decrease of the initial inductance value at 30%. Rated current (Itemp) is specified when temperature of the inductor is raised 40°C by DC current.

Continued on the following page. ↗

Continued from the preceding page. ↘

Inductance-Frequency Characteristics (Typ.)



Inductance-Current Characteristics (Typ.)



Temperature Rise Characteristics (Typ.)



DFE252008C Series 1008 (2520) inch (mm)



| Packaging Code | Packaging | Minimum Quantity |
|----------------|------------------------|------------------|
| =P2 | ø180mm Embossed Taping | 3000 |

| Part Number (□: packaging code) | Inductance | Inductance Test Frequency | Rated Current (Isat)* | Rated Current (Itemp)* | Max. of DC Resistance |
|------------------------------------|-------------|---------------------------|-----------------------|------------------------|-----------------------|
| DFE252008C-R47M□ | 0.47µH ±20% | 1MHz | 3000mA | 2000mA | 0.060Ω |
| DFE252008C-1R0M□ | 1.0µH ±20% | 1MHz | 2300mA | 1400mA | 0.084Ω |
| DFE252008C-1R5M□ | 1.5µH ±20% | 1MHz | 2000mA | 1200mA | 0.126Ω |
| DFE252008C-2R2M□ | 2.2µH ±20% | 1MHz | 1600mA | 950mA | 0.180Ω |
| DFE252008C-3R3M□ | 3.3µH ±20% | 1MHz | 1300mA | 850mA | 0.252Ω |
| DFE252008C-4R7M□ | 4.7µH ±20% | 1MHz | 1100mA | 650mA | 0.438Ω |

Absolute maximum voltage: 20V DC

Operating temp. range (Self-temp. rise included): -40 to 85°C

Class of Magnetic Shield: Metal Alloy

Only for reflow soldering

*Isat: Rated Current based on Inductance change

*Itemp: Rated Current based on Temperature rise

Rated current (Isat) is specified when the decrease of the initial inductance value at 30%. Rated current (Itemp) is specified when temperature of the inductor is raised 40°C by DC current.

Inductance-Frequency Characteristics (Typ.)



Inductance-Current Characteristics (Typ.)



Temperature Rise Characteristics (Typ.)



DFE252008U Series 1008 (2520) inch (mm)



| Packaging Code | Packaging | Minimum Quantity |
|----------------|------------------------|------------------|
| =P2 | ø180mm Embossed Taping | 3000 |

| Part Number (□: packaging code) | Inductance | Inductance Test Frequency | Rated Current (Isat)* | Rated Current (Itemp)* | Max. of DC Resistance |
|------------------------------------|-------------|---------------------------|-----------------------|------------------------|-----------------------|
| DFE252008U-R47M□ | 0.47μH ±20% | 1MHz | 4500mA | 3000mA | 0.038Ω |
| DFE252008U-1R0M□ | 1.0μH ±20% | 1MHz | 3500mA | 2300mA | 0.070Ω |
| DFE252008U-1R5M□ | 1.5μH ±20% | 1MHz | 2700mA | 1900mA | 0.103Ω |
| DFE252008U-2R2M□ | 2.2μH ±20% | 1MHz | 2300mA | 1500mA | 0.150Ω |
| DFE252008U-4R7M□ | 4.7μH ±20% | 1MHz | 1600mA | 1000mA | 0.340Ω |
| DFE252008U-100M□ | 10μH ±20% | 1MHz | 1000mA | 600mA | 0.880Ω |

Absolute maximum voltage: 20V DC

Operating temp. range (Self-temp. rise included): -40 to 85°C

Class of Magnetic Shield: Metal Alloy

Only for reflow soldering

*Isat: Rated Current based on Inductance change

*Itemp: Rated Current based on Temperature rise

Rated current (Isat) is specified when the decrease of the initial inductance value at 30%. Rated current (Itemp) is specified when temperature of the inductor is raised 40°C by DC current.

Inductance-Frequency Characteristics (Typ.)



Inductance-Current Characteristics (Typ.)



Temperature Rise Characteristics (Typ.)



DFE252010C Series 1008 (2520) inch (mm)



| Packaging Code | Packaging | Minimum Quantity |
|----------------|------------------------|------------------|
| =P2 | ø180mm Embossed Taping | 3000 |

Continued on the following page. ↗

Continued from the preceding page. ↘

| Part Number (□: packaging code) | Inductance | Inductance Test Frequency | Rated Current (Isat)* | Rated Current (Itemp)* | Max. of DC Resistance |
|------------------------------------|-------------|------------------------------|-----------------------|------------------------|-----------------------|
| 1269AS-H-R47M□ | 0.47μH ±20% | 1MHz | 3500mA | 3100mA | 0.046Ω |
| 1269AS-H-1R0M□ | 1.0μH ±20% | 1MHz | 2700mA | 2500mA | 0.078Ω |
| 1269AS-H-1R5M□ | 1.5μH ±20% | 1MHz | 2100mA | 1900mA | 0.108Ω |
| 1269AS-H-2R2M□ | 2.2μH ±20% | 1MHz | 1900mA | 1500mA | 0.156Ω |
| 1269AS-H-3R3M□ | 3.3μH ±20% | 1MHz | 1500mA | 1200mA | 0.228Ω |
| 1269AS-H-4R7M□ | 4.7μH ±20% | 1MHz | 1300mA | 1000mA | 0.300Ω |
| 1269AS-H-6R8M□ | 6.8μH ±20% | 1MHz | 1100mA | 760mA | 0.516Ω |
| 1269AS-H-100N□ | 10μH ±30% | 1MHz | 1000mA | 680mA | 0.689Ω |

Absolute maximum voltage: 20V DC

Operating temp. range (Self-temp. rise included): -40 to 85°C

Class of Magnetic Shield: Metal Alloy

Only for reflow soldering

*Isat: Rated Current based on Inductance change

*Itemp: Rated Current based on Temperature rise

Rated current (Isat) is specified when the decrease of the initial inductance value at 30%. Rated current (Itemp) is specified when temperature of the inductor is raised 40°C by DC current.

Inductance-Frequency Characteristics (Typ.)



Inductance-Current Characteristics (Typ.)



Temperature Rise Characteristics (Typ.)



DFE252010F Series 1008 (2520) inch (mm)



(in mm)

| Packaging Code | Packaging | Minimum Quantity |
|----------------|------------------------|------------------|
| =P2 | ø180mm Embossed Taping | 3000 |

| Part Number (□: packaging code) | Inductance | Inductance Test Frequency | Rated Current (Isat)* | Rated Current (Itemp)* | Max. of DC Resistance |
|------------------------------------|-------------|------------------------------|-----------------------|------------------------|-----------------------|
| DFE252010F-R33M□ | 0.33μH ±20% | 1MHz | 6800mA | 4800mA | 0.021Ω |
| DFE252010F-R47M□ | 0.47μH ±20% | 1MHz | 6000mA | 4400mA | 0.027Ω |
| DFE252010F-R68M□ | 0.68μH ±20% | 1MHz | 5000mA | 3500mA | 0.037Ω |
| DFE252010F-R82M□ | 0.82μH ±20% | 1MHz | 4500mA | 3300mA | 0.040Ω |
| DFE252010F-1R0M□ | 1.0μH ±20% | 1MHz | 4100mA | 3100mA | 0.048Ω |
| DFE252010F-1R5M□ | 1.5μH ±20% | 1MHz | 3400mA | 2500mA | 0.072Ω |
| DFE252010F-2R2M□ | 2.2μH ±20% | 1MHz | 3100mA | 2300mA | 0.097Ω |
| DFE252010F-3R3M□ | 3.3μH ±20% | 1MHz | 2200mA | 1600mA | 0.170Ω |

Absolute maximum voltage: 20V DC

Operating temp. range (Self-temp. rise included): -40 to 125°C

Class of Magnetic Shield: Metal Alloy

Only for reflow soldering

*Isat: Rated Current based on Inductance change

*Itemp: Rated Current based on Temperature rise

Rated current (Isat) is specified when the decrease of the initial inductance value at 30%. Rated current (Itemp) is specified when temperature of the inductor is raised 40°C by DC current.

Continued on the following page. ↗

Continued from the preceding page. ↘

| Part Number (□: packaging code) | Inductance | Inductance Test Frequency | Rated Current (Isat)* | Rated Current (Itemp)* | Max. of DC Resistance |
|------------------------------------|------------|------------------------------|-----------------------|------------------------|-----------------------|
| DFE252010F-4R7M□ | 4.7μH ±20% | 1MHz | 1900mA | 1400mA | 0.240Ω |
| DFE252010F-6R8M□ | 6.8μH ±20% | 1MHz | 1400mA | 1100mA | 0.420Ω |
| DFE252010F-8R2M□ | 8.2μH ±20% | 1MHz | 1350mA | 1000mA | 0.520Ω |
| DFE252010F-100M□ | 10μH ±20% | 1MHz | 1300mA | 900mA | 0.600Ω |

Absolute maximum voltage: 20V DC

Operating temp. range (Self-temp. rise included): -40 to 125°C

Class of Magnetic Shield: Metal Alloy

Only for reflow soldering

*Isat: Rated Current based on Inductance change

*Itemp: Rated Current based on Temperature rise

Rated current (Isat) is specified when the decrease of the initial inductance value at 30%. Rated current (Itemp) is specified when temperature of the inductor is raised 40°C by DC current.

Inductance-Frequency Characteristics (Typ.)



Inductance-Current Characteristics (Typ.)



Temperature Rise Characteristics (Typ.)



DFE252010P Series 1008 (2520) inch (mm)



(in mm)

| Packaging Code | Packaging | Minimum Quantity |
|----------------|------------------------|------------------|
| =P2 | ø180mm Embossed Taping | 3000 |

| Part Number (□: packaging code) | Inductance | Inductance Test Frequency | Rated Current (Isat)* | Rated Current (Itemp)* | Max. of DC Resistance |
|------------------------------------|-------------|------------------------------|-----------------------|------------------------|-----------------------|
| DFE252010P-R33M□ | 0.33μH ±20% | 1MHz | 5700mA | 3800mA | 0.029Ω |
| DFE252010P-R47M□ | 0.47μH ±20% | 1MHz | 5000mA | 3500mA | 0.035Ω |
| DFE252010P-R68M□ | 0.68μH ±20% | 1MHz | 4100mA | 3000mA | 0.048Ω |
| DFE252010P-1R0M□ | 1.0μH ±20% | 1MHz | 3800mA | 2700mA | 0.054Ω |
| DFE252010P-1R2M□ | 1.2μH ±20% | 1MHz | 3200mA | 2400mA | 0.068Ω |
| DFE252010P-1R5M□ | 1.5μH ±20% | 1MHz | 3000mA | 2100mA | 0.082Ω |
| DFE252010P-2R2M□ | 2.2μH ±20% | 1MHz | 2600mA | 1700mA | 0.115Ω |
| DFE252010P-3R3M□ | 3.3μH ±20% | 1MHz | 2100mA | 1400mA | 0.195Ω |
| DFE252010P-4R7M□ | 4.7μH ±20% | 1MHz | 1700mA | 1100mA | 0.270Ω |

Absolute maximum voltage: 20V DC

Operating temp. range (Self-temp. rise included): -40 to 125°C

Class of Magnetic Shield: Metal Alloy

Only for reflow soldering

*Isat: Rated Current based on Inductance change

*Itemp: Rated Current based on Temperature rise

Rated current (Isat) is specified when the decrease of the initial inductance value at 30%. Rated current (Itemp) is specified when temperature of the inductor is raised 40°C by DC current.

Continued on the following page. ↗

Continued from the preceding page. ↘

Inductance-Frequency Characteristics (Typ.)



Inductance-Current Characteristics (Typ.)



Temperature Rise Characteristics (Typ.)



DFE252010R Series 1008 (2520) inch (mm)



(in mm)

| Packaging Code | Packaging | Minimum Quantity |
|----------------|------------------------|------------------|
| =P2 | ø180mm Embossed Taping | 3000 |

| Part Number (□: packaging code) | Inductance | Inductance Test Frequency | Rated Current (Isat)* | Rated Current (Itemp)* | Max. of DC Resistance |
|------------------------------------|------------|---------------------------|-----------------------|------------------------|-----------------------|
| DFE252010R-H-1R0M□ | 1.0µH ±20% | 1MHz | 3000mA | 2700mA | 0.068Ω |
| DFE252010R-H-1R5M□ | 1.5µH ±20% | 1MHz | 2300mA | 2100mA | 0.090Ω |
| DFE252010R-H-2R2M□ | 2.2µH ±20% | 1MHz | 2100mA | 1700mA | 0.126Ω |
| DFE252010R-H-4R7M□ | 4.7µH ±20% | 1MHz | 1400mA | 1100mA | 0.276Ω |

Absolute maximum voltage: 20V DC

Operating temp. range (Self-temp. rise included): -40 to 85°C

Class of Magnetic Shield: Metal Alloy

Only for reflow soldering

*Isat: Rated Current based on Inductance change

*Itemp: Rated Current based on Temperature rise

Rated current (Isat) is specified when the decrease of the initial inductance value at 30%. Rated current (Itemp) is specified when temperature of the inductor is raised 40°C by DC current.

Inductance-Frequency Characteristics (Typ.)



Inductance-Current Characteristics (Typ.)



Temperature Rise Characteristics (Typ.)



DFE252012C Series 1008 (2520) inch (mm)



| Packaging Code | Packaging | Minimum Quantity |
|----------------|------------------------|------------------|
| =P2 | ø180mm Embossed Taping | 3000 |

| Part Number (□: packaging code) | Inductance | Inductance Test Frequency | Rated Current (Isat)* | Rated Current (Itemp)* | Max. of DC Resistance |
|------------------------------------|-------------|---------------------------|-----------------------|------------------------|-----------------------|
| 1239AS-H-R47M□ | 0.47μH ±20% | 1MHz | 3800mA | 3700mA | 0.039Ω |
| 1239AS-H-1R0M□ | 1.0μH ±20% | 1MHz | 3000mA | 3000mA | 0.059Ω |
| 1239AS-H-1R5M□ | 1.5μH ±20% | 1MHz | 2600mA | 2400mA | 0.072Ω |
| 1239AS-H-2R2M□ | 2.2μH ±20% | 1MHz | 2200mA | 2000mA | 0.108Ω |
| 1239AS-H-3R3M□ | 3.3μH ±20% | 1MHz | 1800mA | 1500mA | 0.144Ω |
| 1239AS-H-4R7M□ | 4.7μH ±20% | 1MHz | 1500mA | 1300mA | 0.240Ω |
| 1239AS-H-6R0M□ | 6.0μH ±20% | 1MHz | 1400mA | 1100mA | 0.275Ω |
| 1239AS-H-6R8M□ | 6.8μH ±20% | 1MHz | 1300mA | 1000mA | 0.375Ω |
| 1239AS-H-100M□ | 10μH ±20% | 1MHz | 1000mA | 850mA | 0.460Ω |

Absolute maximum voltage: 20V DC

Operating temp. range (Self-temp. rise included): -40 to 85°C

Class of Magnetic Shield: Metal Alloy

Only for reflow soldering

*Isat: Rated Current based on Inductance change

*Itemp: Rated Current based on Temperature rise

Rated current (Isat) is specified when the decrease of the initial inductance value at 30%. Rated current (Itemp) is specified when temperature of the inductor is raised 40°C by DC current.

Inductance-Frequency Characteristics (Typ.)



Inductance-Current Characteristics (Typ.)



Temperature Rise Characteristics (Typ.)



DFE252012F Series 1008 (2520) inch (mm)



| Packaging Code | Packaging | Minimum Quantity |
|----------------|------------------------|------------------|
| =P2 | ø180mm Embossed Taping | 3000 |

Continued on the following page. ↗

Continued from the preceding page. ↘

| Part Number (□: packaging code) | Inductance | Inductance Test Frequency | Rated Current (Isat)* | Rated Current (Itemp)* | Max. of DC Resistance |
|------------------------------------|-------------|------------------------------|-----------------------|------------------------|-----------------------|
| DFE252012F-R33M□ | 0.33μH ±20% | 1MHz | 7600mA | 5100mA | 0.019Ω |
| DFE252012F-R47M□ | 0.47μH ±20% | 1MHz | 6700mA | 4900mA | 0.023Ω |
| DFE252012F-R68M□ | 0.68μH ±20% | 1MHz | 5400mA | 3900mA | 0.031Ω |
| DFE252012F-R82M□ | 0.82μH ±20% | 1MHz | 4900mA | 3600mA | 0.035Ω |
| DFE252012F-1R0M□ | 1.0μH ±20% | 1MHz | 4700mA | 3300mA | 0.040Ω |
| DFE252012F-1R5M□ | 1.5μH ±20% | 1MHz | 3800mA | 2700mA | 0.058Ω |
| DFE252012F-2R2M□ | 2.2μH ±20% | 1MHz | 3300mA | 2300mA | 0.082Ω |
| DFE252012F-3R3M□ | 3.3μH ±20% | 1MHz | 2500mA | 1800mA | 0.135Ω |
| DFE252012F-4R7M□ | 4.7μH ±20% | 1MHz | 2100mA | 1500mA | 0.190Ω |
| DFE252012F-6R8M□ | 6.8μH ±20% | 1MHz | 1700mA | 1200mA | 0.330Ω |
| DFE252012F-8R2M□ | 8.2μH ±20% | 1MHz | 1500mA | 1100mA | 0.410Ω |
| DFE252012F-100M□ | 10μH ±20% | 1MHz | 1400mA | 950mA | 0.480Ω |

Absolute maximum voltage: 20V DC

Operating temp. range (Self-temp. rise included): -40 to 125°C

Class of Magnetic Shield: Metal Alloy

Only for reflow soldering

*Isat: Rated Current based on Inductance change

*Itemp: Rated Current based on Temperature rise

Rated current (Isat) is specified when the decrease of the initial inductance value at 30%. Rated current (Itemp) is specified when temperature of the inductor is raised 40°C by DC current.

Inductance-Frequency Characteristics (Typ.)



Inductance-Current Characteristics (Typ.)



Temperature Rise Characteristics (Typ.)



DFE252012P Series 1008 (2520) inch (mm)



(in mm)

| Packaging Code | Packaging | Minimum Quantity |
|----------------|------------------------|------------------|
| =P2 | ø180mm Embossed Taping | 3000 |

| Part Number (□: packaging code) | Inductance | Inductance Test Frequency | Rated Current (Isat)* | Rated Current (Itemp)* | Max. of DC Resistance |
|------------------------------------|-------------|------------------------------|-----------------------|------------------------|-----------------------|
| DFE252012P-R33M□ | 0.33μH ±20% | 1MHz | 6600mA | 4600mA | 0.023Ω |
| DFE252012P-R47M□ | 0.47μH ±20% | 1MHz | 5700mA | 4000mA | 0.027Ω |
| DFE252012P-R68M□ | 0.68μH ±20% | 1MHz | 4800mA | 3500mA | 0.037Ω |
| DFE252012P-1R0M□ | 1.0μH ±20% | 1MHz | 4300mA | 3200mA | 0.042Ω |

Absolute maximum voltage: 20V DC

Operating temp. range (Self-temp. rise included): -40 to 125°C

Class of Magnetic Shield: Metal Alloy

Only for reflow soldering

*Isat: Rated Current based on Inductance change

*Itemp: Rated Current based on Temperature rise

Rated current (Isat) is specified when the decrease of the initial inductance value at 30%. Rated current (Itemp) is specified when temperature of the inductor is raised 40°C by DC current.

Continued on the following page. ↗

Continued from the preceding page. ↘

| Part Number (□: packaging code) | Inductance | Inductance Test Frequency | Rated Current (Isat)* | Rated Current (Itemp)* | Max. of DC Resistance |
|------------------------------------|------------|------------------------------|-----------------------|------------------------|-----------------------|
| DFE252012P-1R5M□ | 1.5μH ±20% | 1MHz | 3500mA | 2600mA | 0.060Ω |
| DFE252012P-2R2M□ | 2.2μH ±20% | 1MHz | 3000mA | 2200mA | 0.084Ω |
| DFE252012P-3R3M□ | 3.3μH ±20% | 1MHz | 2300mA | 1700mA | 0.140Ω |
| DFE252012P-4R7M□ | 4.7μH ±20% | 1MHz | 2000mA | 1400mA | 0.200Ω |

Absolute maximum voltage: 20V DC

Operating temp. range (Self-temp. rise included): -40 to 125°C

Class of Magnetic Shield: Metal Alloy

Only for reflow soldering

*Isat: Rated Current based on Inductance change

*Itemp: Rated Current based on Temperature rise

Rated current (Isat) is specified when the decrease of the initial inductance value at 30%. Rated current (Itemp) is specified when temperature of the inductor is raised 40°C by DC current.

Inductance-Frequency Characteristics (Typ.)



Inductance-Current Characteristics (Typ.)



Temperature Rise Characteristics (Typ.)



DFE252012R Series 1008 (2520) inch (mm)



(in mm)

| Packaging Code | Packaging | Minimum Quantity |
|----------------|------------------------|------------------|
| =P2 | ø180mm Embossed Taping | 3000 |

| Part Number (□: packaging code) | Inductance | Inductance Test Frequency | Rated Current (Isat)* | Rated Current (Itemp)* | Max. of DC Resistance |
|------------------------------------|------------|------------------------------|-----------------------|------------------------|-----------------------|
| DFE252012R-H-1R0M□ | 1.0μH ±20% | 1MHz | 3400mA | 3100mA | 0.049Ω |
| DFE252012R-H-1R5M□ | 1.5μH ±20% | 1MHz | 2800mA | 2500mA | 0.065Ω |
| DFE252012R-H-2R2M□ | 2.2μH ±20% | 1MHz | 2400mA | 2000mA | 0.090Ω |
| DFE252012R-H-4R7M□ | 4.7μH ±20% | 1MHz | 1700mA | 1400mA | 0.216Ω |

Absolute maximum voltage: 20V DC

Operating temp. range (Self-temp. rise included): -40 to 85°C

Class of Magnetic Shield: Metal Alloy

Only for reflow soldering

*Isat: Rated Current based on Inductance change

*Itemp: Rated Current based on Temperature rise

Rated current (Isat) is specified when the decrease of the initial inductance value at 30%. Rated current (Itemp) is specified when temperature of the inductor is raised 40°C by DC current.

Continued on the following page. ↗

Inductors for Power Lines
 DFE252012R
 Inductors for General Circuits
 RF Inductors

Continued from the preceding page. ↘

Inductance-Frequency Characteristics (Typ.)



Inductance-Current Characteristics (Typ.)

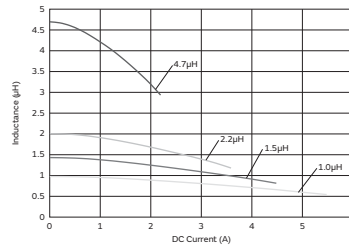

Temperature Rise Characteristics (Typ.)



DFE322510C Series 1210 (3225) inch (mm)



| Packaging Code | Packaging | Minimum Quantity |
|----------------|------------------------|------------------|
| =P2 | ø180mm Embossed Taping | 3000 |

| Part Number (□: packaging code) | Inductance | Inductance Test Frequency | Rated Current (Isat)* | Rated Current (Itemp)* | Max. of DC Resistance |
|------------------------------------|-------------|---------------------------|-----------------------|------------------------|-----------------------|
| 1276AS-H-R47M□ | 0.47µH ±20% | 1MHz | 3800mA | 3300mA | 0.038Ω |
| 1276AS-H-R68M□ | 0.68µH ±20% | 1MHz | 3500mA | 2900mA | 0.045Ω |
| 1276AS-H-1R0M□ | 1.0µH ±20% | 1MHz | 3100mA | 2600mA | 0.062Ω |
| 1276AS-H-1R5M□ | 1.5µH ±20% | 1MHz | 2600mA | 2100mA | 0.087Ω |
| 1276AS-H-2R2M□ | 2.2µH ±20% | 1MHz | 2200mA | 1600mA | 0.118Ω |
| 1276AS-H-3R3M□ | 3.3µH ±20% | 1MHz | 1800mA | 1400mA | 0.190Ω |
| 1276AS-H-4R7M□ | 4.7µH ±20% | 1MHz | 1600mA | 1200mA | 0.264Ω |
| 1276AS-H-6R8M□ | 6.8µH ±20% | 1MHz | 1300mA | 1000mA | 0.378Ω |
| 1276AS-H-100M□ | 10µH ±20% | 1MHz | 1000mA | 800mA | 0.588Ω |

Absolute maximum voltage: 20V DC

Operating temp. range (Self-temp. rise included): -40 to 85°C

Class of Magnetic Shield: Metal Alloy

Only for reflow soldering

*Isat: Rated Current based on Inductance change

*Itemp: Rated Current based on Temperature rise

Rated current (Isat) is specified when the decrease of the initial inductance value at 30%. Rated current (Itemp) is specified when temperature of the inductor is raised 40°C by DC current.

Inductance-Frequency Characteristics (Typ.)



Inductance-Current Characteristics (Typ.)



Temperature Rise Characteristics (Typ.)



DFE322512C Series 1210 (3225) inch (mm)



| Packaging Code | Packaging | Minimum Quantity |
|----------------|------------------------|------------------|
| =P2 | ø180mm Embossed Taping | 3000 |

| Part Number (□: packaging code) | Inductance | Inductance Test Frequency | Rated Current (Isat)* | Rated Current (Itemp)* | Max. of DC Resistance |
|------------------------------------|-------------|---------------------------|-----------------------|------------------------|-----------------------|
| 1277AS-H-R47M□ | 0.47μH ±20% | 1MHz | 4700mA | 3700mA | 0.031Ω |
| 1277AS-H-R68M□ | 0.68μH ±20% | 1MHz | 4200mA | 3500mA | 0.035Ω |
| 1277AS-H-1R0M□ | 1.0μH ±20% | 1MHz | 3700mA | 3100mA | 0.045Ω |
| 1277AS-H-1R5M□ | 1.5μH ±20% | 1MHz | 3000mA | 2600mA | 0.065Ω |
| 1277AS-H-2R2M□ | 2.2μH ±20% | 1MHz | 2600mA | 2100mA | 0.084Ω |
| 1277AS-H-3R3M□ | 3.3μH ±20% | 1MHz | 2100mA | 1800mA | 0.126Ω |
| 1277AS-H-4R7M□ | 4.7μH ±20% | 1MHz | 1800mA | 1400mA | 0.180Ω |
| 1277AS-H-6R8M□ | 6.8μH ±20% | 1MHz | 1500mA | 1200mA | 0.276Ω |
| 1277AS-H-100M□ | 10μH ±20% | 1MHz | 1200mA | 900mA | 0.420Ω |

Absolute maximum voltage: 20V DC

Operating temp. range (Self-temp. rise included): -40 to 85°C

Class of Magnetic Shield: Metal Alloy

Only for reflow soldering

*Isat: Rated Current based on Inductance change

*Itemp: Rated Current based on Temperature rise

Rated current (Isat) is specified when the decrease of the initial inductance value at 30%. Rated current (Itemp) is specified when temperature of the inductor is raised 40°C by DC current.

Inductance-Frequency Characteristics (Typ.)



Inductance-Current Characteristics (Typ.)



Temperature Rise Characteristics (Typ.)



DFE322512F Series 1210 (3225) inch (mm)



| Packaging Code | Packaging | Minimum Quantity |
|----------------|------------------------|------------------|
| =P2 | ø180mm Embossed Taping | 3000 |

Continued on the following page. ↗

Continued from the preceding page. ↘

| Part Number (□: packaging code) | Inductance | Inductance Test Frequency | Rated Current (Isat)* | Rated Current (Itemp)* | Max. of DC Resistance |
|------------------------------------|-------------|------------------------------|-----------------------|------------------------|-----------------------|
| DFE322512F-R47M□ | 0.47μH ±20% | 1MHz | 6700mA | 4800mA | 0.023Ω |
| DFE322512F-R68M□ | 0.68μH ±20% | 1MHz | 6100mA | 4400mA | 0.026Ω |
| DFE322512F-1R0M□ | 1.0μH ±20% | 1MHz | 4800mA | 3800mA | 0.032Ω |
| DFE322512F-1R5M□ | 1.5μH ±20% | 1MHz | 3900mA | 3000mA | 0.048Ω |
| DFE322512F-2R2M□ | 2.2μH ±20% | 1MHz | 3400mA | 2600mA | 0.066Ω |
| DFE322512F-3R3M□ | 3.3μH ±20% | 1MHz | 2600mA | 2000mA | 0.108Ω |
| DFE322512F-4R7M□ | 4.7μH ±20% | 1MHz | 2300mA | 1600mA | 0.157Ω |
| DFE322512F-6R8M□ | 6.8μH ±20% | 1MHz | 2000mA | 1200mA | 0.220Ω |
| DFE322512F-100M□ | 10μH ±20% | 1MHz | 1700mA | 1100mA | 0.324Ω |

Absolute maximum voltage: 20V DC

Operating temp. range (Self-temp. rise included): -40 to 125°C

Class of Magnetic Shield: Metal Alloy

Only for reflow soldering

*Isat: Rated Current based on Inductance change

*Itemp: Rated Current based on Temperature rise

Rated current (Isat) is specified when the decrease of the initial inductance value at 30%. Rated current (Itemp) is specified when temperature of the inductor is raised 40°C by DC current.

Inductance-Frequency Characteristics (Typ.)



Inductance-Current Characteristics (Typ.)



Temperature Rise Characteristics (Typ.)



FDSD0412 Series 1515 (4040) inch (mm)



| Packaging Code | Packaging | Minimum Quantity |
|----------------|------------------------|------------------|
| =P3 | ø330mm Embossed Taping | 4000 |

| Part Number (□: packaging code) | Inductance | Inductance Test Frequency | Rated Current (Isat)* | Rated Current (Itemp)* | Max. of DC Resistance |
|------------------------------------|-------------|------------------------------|-----------------------|------------------------|-----------------------|
| FDSD0412-H-R33M□ | 0.33μH ±20% | 0.1MHz | 7500mA | 6400mA | 0.019Ω |
| FDSD0412-H-R47M□ | 0.47μH ±20% | 0.1MHz | 6500mA | 6000mA | 0.023Ω |
| FDSD0412-H-1R0M□ | 1.0μH ±20% | 0.1MHz | 4700mA | 4300mA | 0.044Ω |
| FDSD0412-H-1R2M□ | 1.2μH ±20% | 0.1MHz | 4500mA | 3700mA | 0.048Ω |
| FDSD0412-H-1R5M□ | 1.5μH ±20% | 0.1MHz | 4100mA | 3300mA | 0.064Ω |
| FDSD0412-H-2R2M□ | 2.2μH ±20% | 0.1MHz | 3500mA | 2800mA | 0.084Ω |
| FDSD0412-H-3R3M□ | 3.3μH ±20% | 0.1MHz | 2800mA | 2200mA | 0.122Ω |

Absolute maximum voltage: 30V DC

Operating temp. range (Self-temp. rise included): -40 to 125°C

Class of Magnetic Shield: Metal Alloy

Only for reflow soldering

*Isat: Rated Current based on Inductance change

*Itemp: Rated Current based on Temperature rise

Rated current (Isat) is specified when the decrease of the initial inductance value at 30%. Rated current (Itemp) is specified when temperature of the inductor is raised 40°C by DC current.

Continued on the following page. ↗

Continued from the preceding page. ↘

| Part Number (□: packaging code) | Inductance | Inductance Test Frequency | Rated Current (Isat)* | Rated Current (Itemp)* | Max. of DC Resistance |
|------------------------------------|------------|------------------------------|-----------------------|------------------------|-----------------------|
| FDSD0412-H-4R7M □ | 4.7μH ±20% | 0.1MHz | 2500mA | 1900mA | 0.161Ω |

Absolute maximum voltage: 30V DC

Operating temp. range (Self-temp. rise included): -40 to 125°C

Class of Magnetic Shield: Metal Alloy

Only for reflow soldering

*Isat: Rated Current based on Inductance change

*Itemp: Rated Current based on Temperature rise

Rated current (Isat) is specified when the decrease of the initial inductance value at 30%. Rated current (Itemp) is specified when temperature of the inductor is raised 40°C by DC current.

Inductance-Frequency Characteristics (Typ.)



Inductance-Current Characteristics (Typ.)



Temperature Rise Characteristics (Typ.)



FDSD0415 Series 1515 (4040) inch (mm)



| Packaging Code | Packaging | Minimum Quantity |
|----------------|------------------------|------------------|
| =P3 | ø330mm Embossed Taping | 4000 |

| Part Number (□: packaging code) | Inductance | Inductance Test Frequency | Rated Current (Isat)* | Rated Current (Itemp)* | Max. of DC Resistance |
|------------------------------------|-------------|------------------------------|-----------------------|------------------------|-----------------------|
| FDSD0415-H-R22M □ | 0.22μH ±20% | 0.1MHz | 12000mA | 7700mA | 0.014Ω |
| FDSD0415-H-R47M □ | 0.47μH ±20% | 0.1MHz | 9000mA | 6100mA | 0.018Ω |
| FDSD0415-H-1R0M □ | 1.0μH ±20% | 0.1MHz | 5300mA | 4500mA | 0.041Ω |
| FDSD0415-H-1R5M □ | 1.5μH ±20% | 0.1MHz | 5000mA | 3700mA | 0.047Ω |
| FDSD0415-H-2R2M □ | 2.2μH ±20% | 0.1MHz | 4100mA | 3100mA | 0.065Ω |
| FDSD0415-H-3R3M □ | 3.3μH ±20% | 0.1MHz | 3400mA | 2600mA | 0.095Ω |
| FDSD0415-H-4R7M □ | 4.7μH ±20% | 0.1MHz | 2900mA | 2100mA | 0.120Ω |

Absolute maximum voltage: 30V DC

Operating temp. range (Self-temp. rise included): -40 to 125°C

Class of Magnetic Shield: Metal Alloy

Only for reflow soldering

*Isat: Rated Current based on Inductance change

*Itemp: Rated Current based on Temperature rise

Rated current (Isat) is specified when the decrease of the initial inductance value at 30%. Rated current (Itemp) is specified when temperature of the inductor is raised 40°C by DC current.

Continued on the following page. ↗

Inductors for Power Lines
FDSD0415

Inductors for General Circuits

RF Inductors

Continued from the preceding page. ↘

Inductance-Frequency Characteristics (Typ.)



Inductance-Current Characteristics (Typ.)



Temperature Rise Characteristics (Typ.)



FDSD0420 Series 1515 (4040) inch (mm)



| Packaging Code | Packaging | Minimum Quantity |
|----------------|------------------------|------------------|
| =P3 | ø330mm Embossed Taping | 2000 |

| Part Number (□: packaging code) | Inductance | Inductance Test Frequency | Rated Current (Isat)* | Rated Current (Itemp)* | Max. of DC Resistance |
|------------------------------------|-------------|---------------------------|-----------------------|------------------------|-----------------------|
| FDSD0420-H-R33M□ | 0.33µH ±20% | 0.1MHz | 11000mA | 7700mA | 0.014Ω |
| FDSD0420-H-R47M□ | 0.47µH ±20% | 0.1MHz | 9400mA | 6800mA | 0.018Ω |
| FDSD0420-H-R68M□ | 0.68µH ±20% | 0.1MHz | 8300mA | 6500mA | 0.022Ω |
| FDSD0420-H-1R0M□ | 1.0µH ±20% | 0.1MHz | 6800mA | 5100mA | 0.029Ω |
| FDSD0420-H-1R5M□ | 1.5µH ±20% | 0.1MHz | 5700mA | 4300mA | 0.036Ω |
| FDSD0420-H-2R2M□ | 2.2µH ±20% | 0.1MHz | 4100mA | 3600mA | 0.047Ω |
| FDSD0420-H-3R3M□ | 3.3µH ±20% | 0.1MHz | 3700mA | 2900mA | 0.071Ω |
| FDSD0420-H-4R7M□ | 4.7µH ±20% | 0.1MHz | 3600mA | 2700mA | 0.083Ω |
| FDSD0420-H-6R8M□ | 6.8µH ±20% | 0.1MHz | 2700mA | 1900mA | 0.150Ω |
| FDSD0420-H-100M□ | 10µH ±20% | 0.1MHz | 2500mA | 1700mA | 0.200Ω |

Absolute maximum voltage: 30V DC

Operating temp. range (Self-temp. rise included): -40 to 125°C

Class of Magnetic Shield: Metal Alloy

Only for reflow soldering

*Isat: Rated Current based on Inductance change

*Itemp: Rated Current based on Temperature rise

Rated current (Isat) is specified when the decrease of the initial inductance value at 30%. Rated current (Itemp) is specified when temperature of the inductor is raised 40°C by DC current.

Inductance-Frequency Characteristics (Typ.)



Inductance-Current Characteristics (Typ.)



Temperature Rise Characteristics (Typ.)

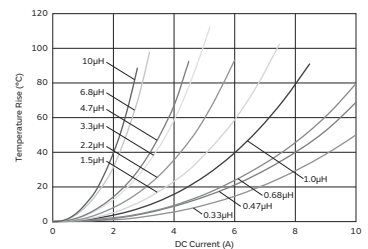

FDSD0420

Inductors for Power Lines

Inductors for General Circuits

RF Inductors

FDSD0420W Series 1515 (4040) inch (mm)



| Packaging Code | Packaging | Minimum Quantity |
|----------------|------------------------|------------------|
| =P3 | ø330mm Embossed Taping | 2000 |

| Part Number (□: packaging code) | Inductance | Inductance Test Frequency | Rated Current (Isat)* | Rated Current (Itemp)* | Max. of DC Resistance |
|------------------------------------|------------|------------------------------|-----------------------|------------------------|-----------------------|
| FDSD0420W-H-150M□ | 15μH ±20% | 0.1MHz | 1900mA | 1100mA | 0.35Ω |
| FDSD0420W-H-220M□ | 22μH ±20% | 0.1MHz | 1500mA | 820mA | 0.54Ω |

Absolute maximum voltage: 30V DC

Operating temp. range (Self-temp. rise included): -40 to 125°C

Class of Magnetic Shield: Metal Alloy

Only for reflow soldering

*Isat: Rated Current based on Inductance change

*Itemp: Rated Current based on Temperature rise

Rated current (Isat) is specified when the decrease of the initial inductance value at 30%. Rated current (Itemp) is specified when temperature of the inductor is raised 40°C by DC current.

Inductance-Current Characteristics (Typ.)



Temperature Rise Characteristics (Typ.)



FDSD0512 Series 2019 (5249) inch (mm)



| Packaging Code | Packaging | Minimum Quantity |
|----------------|------------------------|------------------|
| =P3 | ø330mm Embossed Taping | 4000 |

Continued on the following page. ↗

Continued from the preceding page. ↘

| Part Number (□: packaging code) | Inductance | Inductance Test Frequency | Rated Current (Isat)* | Rated Current (Itemp)* | Max. of DC Resistance |
|------------------------------------|------------|------------------------------|-----------------------|------------------------|-----------------------|
| FDSD0512-H-1R0M □ | 1.0μH ±20% | 0.1MHz | 6100mA | 4000mA | 0.044Ω |
| FDSD0512-H-K2R2M □ | 2.2μH ±20% | 0.1MHz | 4200mA | 3200mA | 0.068Ω |
| FDSD0512-H-4R7M □ | 4.7μH ±20% | 0.1MHz | 3000mA | 2000mA | 0.180Ω |
| FDSD0512-H-6R8M □ | 6.8μH ±20% | 0.1MHz | 2300mA | 1700mA | 0.210Ω |

Absolute maximum voltage: 30V DC

Operating temp. range (Self-temp. rise included): -40 to 125°C

Class of Magnetic Shield: Metal Alloy

Only for reflow soldering

*Isat: Rated Current based on Inductance change

*Itemp: Rated Current based on Temperature rise

Rated current (Isat) is specified when the decrease of the initial inductance value at 30%. Rated current (Itemp) is specified when temperature of the inductor is raised 40°C by DC current.

Inductance-Frequency Characteristics (Typ.)



Inductance-Current Characteristics (Typ.)



Temperature Rise Characteristics (Typ.)



FDSD0515 Series 2019 (5249) inch (mm)



| Packaging Code | Packaging | Minimum Quantity |
|----------------|------------------------|------------------|
| =P3 | ø330mm Embossed Taping | 4000 |

| Part Number (□: packaging code) | Inductance | Inductance Test Frequency | Rated Current (Isat)* | Rated Current (Itemp)* | Max. of DC Resistance |
|------------------------------------|------------|------------------------------|-----------------------|------------------------|-----------------------|
| FDSD0515-H-1R0M □ | 1.0μH ±20% | 0.1MHz | 7000mA | 5200mA | 0.030Ω |
| FDSD0515-H-2R2M □ | 2.2μH ±20% | 0.1MHz | 4800mA | 3400mA | 0.059Ω |
| FDSD0515-H-3R3M □ | 3.3μH ±20% | 0.1MHz | 3800mA | 3000mA | 0.075Ω |
| FDSD0515-H-4R7M □ | 4.7μH ±20% | 0.1MHz | 3200mA | 2600mA | 0.100Ω |

Absolute maximum voltage: 30V DC

Operating temp. range (Self-temp. rise included): -40 to 125°C

Class of Magnetic Shield: Metal Alloy

Only for reflow soldering

*Isat: Rated Current based on Inductance change

*Itemp: Rated Current based on Temperature rise

Rated current (Isat) is specified when the decrease of the initial inductance value at 30%. Rated current (Itemp) is specified when temperature of the inductor is raised 40°C by DC current.

Continued on the following page. ↗

FDSD0515 Inductors for Power Lines

Inductors for General Circuits

RF Inductors

Continued from the preceding page. ↘

Inductance-Frequency Characteristics (Typ.)



Inductance-Current Characteristics (Typ.)



Temperature Rise Characteristics (Typ.)



FDSD0518 Series 2019 (5249) inch (mm)



| Packaging Code | Packaging | Minimum Quantity |
|----------------|------------------------|------------------|
| =P3 | ø330mm Embossed Taping | 2000 |

| Part Number (□: packaging code) | Inductance | Inductance Test Frequency | Rated Current (Isat)* | Rated Current (Itemp)* | Max. of DC Resistance |
|------------------------------------|-------------|---------------------------|-----------------------|------------------------|-----------------------|
| FDSD0518-H-R68M□ | 0.68µH ±20% | 0.1MHz | 9000mA | 6800mA | 0.019Ω |
| FDSD0518-H-1R0M□ | 1.0µH ±20% | 0.1MHz | 8700mA | 6100mA | 0.021Ω |
| FDSD0518-H-1R5M□ | 1.5µH ±20% | 0.1MHz | 6700mA | 5300mA | 0.029Ω |
| FDSD0518-H-2R2M□ | 2.2µH ±20% | 0.1MHz | 5400mA | 4300mA | 0.040Ω |
| FDSD0518-H-3R3M□ | 3.3µH ±20% | 0.1MHz | 4600mA | 3400mA | 0.058Ω |
| FDSD0518-H-4R7M□ | 4.7µH ±20% | 0.1MHz | 3900mA | 3000mA | 0.073Ω |
| FDSD0518-H-6R8M□ | 6.8µH ±20% | 0.1MHz | 2900mA | 2600mA | 0.106Ω |
| FDSD0518-H-100M□ | 10µH ±20% | 0.1MHz | 2700mA | 2400mA | 0.150Ω |

Absolute maximum voltage: 30V DC

Operating temp. range (Self-temp. rise included): -40 to 125°C

Class of Magnetic Shield: Metal Alloy

Only for reflow soldering

*Isat: Rated Current based on Inductance change

*Itemp: Rated Current based on Temperature rise

Rated current (Isat) is specified when the decrease of the initial inductance value at 30%. Rated current (Itemp) is specified when temperature of the inductor is raised 40°C by DC current.

Inductance-Frequency Characteristics (Typ.)



Inductance-Current Characteristics (Typ.)



Temperature Rise Characteristics (Typ.)



FDV0530S Series 2020 (5050) inch (mm)



| Packaging Code | Packaging | Minimum Quantity |
|----------------|------------------------|------------------|
| =P3 | ø330mm Embossed Taping | 2000 |

| Part Number (□: packaging code) | Inductance | Inductance Test Frequency | Rated Current (I _{sat})* | Rated Current (I _{temp})* | Max. of DC Resistance |
|------------------------------------|-------------|---------------------------|------------------------------------|-------------------------------------|-----------------------|
| FDV0530S-H-R12M□ | 0.12μH ±20% | 0.1MHz | 18000mA | 13000mA | 0.0039Ω |
| FDV0530S-H-R24M□ | 0.24μH ±20% | 0.1MHz | 13000mA | 11000mA | 0.0056Ω |
| FDV0530S-H-R42M□ | 0.42μH ±20% | 0.1MHz | 9000mA | 8200mA | 0.0098Ω |
| FDV0530S-H-R60M□ | 0.60μH ±20% | 0.1MHz | 7900mA | 7200mA | 0.012Ω |
| FDV0530S-H-R78M□ | 0.78μH ±20% | 0.1MHz | 7100mA | 6900mA | 0.014Ω |
| FDV0530S-H-1R0M□ | 1.0μH ±20% | 0.1MHz | 6200mA | 5700mA | 0.017Ω |
| FDV0530S-H-1R5M□ | 1.5μH ±20% | 0.1MHz | 5400mA | 4900mA | 0.024Ω |
| FDV0530S-H-2R2M□ | 2.2μH ±20% | 0.1MHz | 4500mA | 4300mA | 0.034Ω |

Absolute maximum voltage: 30V DC

Operating temp. range (Self-temp. rise included): -40 to 125°C

Class of Magnetic Shield: Metal Alloy

Only for reflow soldering

*I_{sat}: Rated Current based on Inductance change

*I_{temp}: Rated Current based on Temperature rise

Rated current (I_{sat}) is specified when the decrease of the initial inductance value at 30%. Rated current (I_{temp}) is specified when temperature of the inductor is raised 40°C by DC current.

Inductance-Current Characteristics (Typ.)



Temperature Rise Characteristics (Typ.)



FDV0530 Series 2423 (6258) inch (mm)



| Packaging Code | Packaging | Minimum Quantity |
|----------------|------------------------|------------------|
| =P3 | ø330mm Embossed Taping | 1000 |

Continued on the following page. ↗

Continued from the preceding page. ↘

| Part Number (□: packaging code) | Inductance | Inductance Test Frequency | Rated Current (Isat)* | Rated Current (Itemp)* | Max. of DC Resistance |
|------------------------------------|-------------|------------------------------|-----------------------|------------------------|-----------------------|
| FDV0530-H-R11M□ | 0.11μH ±20% | 0.1MHz | 19600mA | 18200mA | 0.0016Ω |
| FDV0530-H-R20M□ | 0.2μH ±20% | 0.1MHz | 17500mA | 17700mA | 0.0024Ω |
| FDV0530-H-R36M□ | 0.36μH ±20% | 0.1MHz | 12600mA | 13900mA | 0.0041Ω |
| FDV0530-H-R56M□ | 0.56μH ±20% | 0.1MHz | 11300mA | 11100mA | 0.0063Ω |
| FDV0530-H-R75M□ | 0.75μH ±20% | 0.1MHz | 9900mA | 9700mA | 0.0076Ω |
| FDV0530-H-1R0M□ | 1.0μH ±20% | 0.1MHz | 8400mA | 7700mA | 0.0112Ω |
| FDV0530-H-1R5M□ | 1.5μH ±20% | 0.1MHz | 5700mA | 6600mA | 0.0155Ω |
| FDV0530-H-2R2M□ | 2.2μH ±20% | 0.1MHz | 5300mA | 6000mA | 0.0199Ω |
| FDV0530-H-3R3M□ | 3.3μH ±20% | 0.1MHz | 4100mA | 4500mA | 0.0341Ω |
| FDV0530-H-4R7M□ | 4.7μH ±20% | 0.1MHz | 3500mA | 3600mA | 0.0536Ω |

Absolute maximum voltage: 30V DC

Operating temp. range (Self-temp. rise included): -40 to 125°C

Class of Magnetic Shield: Metal Alloy

Only for reflow soldering

*Isat: Rated Current based on Inductance change

*Itemp: Rated Current based on Temperature rise

Rated current (Isat) is specified when the decrease of the initial inductance value at 20%. Rated current (Itemp) is specified when temperature of the inductor is raised 40°C by DC current.

Inductance-Current Characteristics (Typ.)



Temperature Rise Characteristics (Typ.)



FCUL0530 Series 2522 (6357) inch (mm)



| Packaging Code | Packaging | Minimum Quantity |
|----------------|------------------------|------------------|
| =P3 | ø330mm Embossed Taping | 1000 |

| Part Number (□: packaging code) | Inductance | Inductance Test Frequency | Rated Current (Isat)* | Rated Current (Itemp)* | DC Resistance |
|------------------------------------|-------------|------------------------------|-----------------------|------------------------|---------------|
| FCUL0530-R36M□ | 0.36μH ±20% | 0.1MHz | 17000mA | 18000mA | 0.00240Ω±7% |
| FCUL0530-R47M□ | 0.47μH ±20% | 0.1MHz | 14000mA | 16000mA | 0.00285Ω±7% |

Absolute maximum voltage: 30V DC

Operating temp. range (Self-temp. rise included): -40 to 125°C

Class of Magnetic Shield: Metal Alloy

Only for reflow soldering

*Isat: Rated Current based on Inductance change

*Itemp: Rated Current based on Temperature rise

Rated current (Isat) is specified when the decrease of the initial inductance value at 30%. Rated current (Itemp) is specified when temperature of the inductor is raised 40°C by DC current.

Continued on the following page. ↗

Continued from the preceding page. ↘

Inductance-Frequency Characteristics (Typ.)



Inductance-Current Characteristics (Typ.)



Temperature Rise Characteristics (Typ.)



FDSD0630 Series 2726 (7066) inch (mm)



| Packaging Code | Packaging | Minimum Quantity |
|----------------|------------------------|------------------|
| =P3 | ø330mm Embossed Taping | 1000 |

| Part Number (□: packaging code) | Inductance | Inductance Test Frequency | Rated Current (Isat)* | Rated Current (Itemp)* | Max. of DC Resistance |
|------------------------------------|-------------|---------------------------|-----------------------|------------------------|-----------------------|
| FDSD0630-H-R68M□ | 0.68µH ±20% | 0.1MHz | 17000mA | 9600mA | 0.0086Ω |
| FDSD0630-H-1R0M□ | 1.0µH ±20% | 0.1MHz | 15000mA | 9400mA | 0.0110Ω |
| FDSD0630-H-1R5N□ | 1.5µH ±30% | 0.1MHz | 13000mA | 8500mA | 0.0130Ω |
| FDSD0630-H-2R2M□ | 2.2µH ±20% | 0.1MHz | 12000mA | 7100mA | 0.0170Ω |
| FDSD0630-H-3R3M□ | 3.3µH ±20% | 0.1MHz | 8000mA | 5600mA | 0.0280Ω |
| FDSD0630-H-4R7M□ | 4.7µH ±20% | 0.1MHz | 7600mA | 4700mA | 0.0400Ω |
| FDSD0630-H-5R6M□ | 5.6µH ±20% | 0.1MHz | 7000mA | 4200mA | 0.0460Ω |
| FDSD0630-H-6R8M□ | 6.8µH ±20% | 0.1MHz | 5900mA | 3700mA | 0.0610Ω |
| FDSD0630-H-8R2M□ | 8.2µH ±20% | 0.1MHz | 5500mA | 3400mA | 0.0700Ω |
| FDSD0630-H-100M□ | 10µH ±20% | 0.1MHz | 5400mA | 3200mA | 0.0740Ω |

Absolute maximum voltage: 30V DC

Operating temp. range (Self-temp. rise included): -40 to 125°C

Class of Magnetic Shield: Metal Alloy

Only for reflow soldering

*Isat: Rated Current based on Inductance change

*Itemp: Rated Current based on Temperature rise

Rated current (Isat) is specified when the decrease of the initial inductance value at 30%. Rated current (Itemp) is specified when temperature of the inductor is raised 40°C by DC current.

Inductance-Frequency Characteristics (Typ.)



Inductance-Current Characteristics (Typ.)



Temperature Rise Characteristics (Typ.)



FCUL0624 Series 2926 (7366) inch (mm)



| Packaging Code | Packaging | Minimum Quantity |
|----------------|------------------------|------------------|
| =P3 | ø330mm Embossed Taping | 1500 |

| Part Number (□: packaging code) | Inductance | Inductance Test Frequency | Rated Current (Isat)* | Rated Current (Itemp)* | DC Resistance |
|------------------------------------|-------------|---------------------------|-----------------------|------------------------|---------------|
| FCUL0624-H-R22M□ | 0.22μH ±20% | 0.1MHz | 23000mA | 24000mA | 0.00140Ω±7% |
| FCUL0624-H-R47M□ | 0.47μH ±20% | 0.1MHz | 17000mA | 16000mA | 0.00327Ω±7% |

Absolute maximum voltage: 30V DC

Operating temp. range (Self-temp. rise included): -40 to 125°C

Class of Magnetic Shield: Metal Alloy

Only for reflow soldering

*Isat: Rated Current based on Inductance change

*Itemp: Rated Current based on Temperature rise

Rated current (Isat) is specified when the decrease of the initial inductance value at 30%. Rated current (Itemp) is specified when temperature of the inductor is raised 40°C by DC current.

Inductance-Frequency Characteristics (Typ.)



Inductance-Current Characteristics (Typ.)



Temperature Rise Characteristics (Typ.)



FCUL0630 Series 2926 (7366) inch (mm)



| Packaging Code | Packaging | Minimum Quantity |
|----------------|------------------------|------------------|
| =P3 | ø330mm Embossed Taping | 1000 |

Continued on the following page. ↗

Continued from the preceding page. ↘

| Part Number (□: packaging code) | Inductance | Inductance Test Frequency | Rated Current (Isat)* | Rated Current (Itemp)* | DC Resistance |
|------------------------------------|-------------|---------------------------|-----------------------|------------------------|---------------|
| FCUL0630-H-R12M□ | 0.12μH ±20% | 0.1MHz | 30000mA | 32000mA | 0.00077Ω±7% |
| FCUL0630-H-R22M□ | 0.22μH ±20% | 0.1MHz | 25000mA | 26000mA | 0.00112Ω±7% |
| FCUL0630-H-R36M□ | 0.36μH ±20% | 0.1MHz | 18000mA | 21000mA | 0.00190Ω±7% |
| FCUL0630-H-R47M□ | 0.47μH ±20% | 0.1MHz | 18000mA | 18000mA | 0.00248Ω±7% |
| FCUL0630-H-R56M□ | 0.56μH ±20% | 0.1MHz | 14000mA | 17000mA | 0.00283Ω±7% |
| FCUL0630-H-R68M□ | 0.68μH ±20% | 0.1MHz | 14000mA | 15000mA | 0.00358Ω±7% |

Absolute maximum voltage: 30V DC

Operating temp. range (Self-temp. rise included): -40 to 125°C

Class of Magnetic Shield: Metal Alloy

Only for reflow soldering

*Isat: Rated Current based on Inductance change

*Itemp: Rated Current based on Temperature rise

Rated current (Isat) is specified when the decrease of the initial inductance value at 30%. Rated current (Itemp) is specified when temperature of the inductor is raised 40°C by DC current.

Inductance-Frequency Characteristics (Typ.)



Inductance-Current Characteristics (Typ.)



Temperature Rise Characteristics (Typ.)



FDV0618 Series 2926 (7467) inch (mm)



| Packaging Code | Packaging | Minimum Quantity |
|----------------|------------------------|------------------|
| =P3 | ø330mm Embossed Taping | 1500 |

| Part Number (□: packaging code) | Inductance | Inductance Test Frequency | Rated Current (Isat)* | Rated Current (Itemp)* | Max. of DC Resistance |
|------------------------------------|-------------|---------------------------|-----------------------|------------------------|-----------------------|
| FDV0618-H-R24N□ | 0.24μH ±30% | 0.1MHz | 14000mA | 13000mA | 0.0045Ω |
| FDV0618-H-R35N□ | 0.35μH ±30% | 0.1MHz | 11000mA | 10000mA | 0.0068Ω |
| FDV0618-H-R68M□ | 0.68μH ±20% | 0.1MHz | 9800mA | 8700mA | 0.0100Ω |
| FDV0618-H-1R0M□ | 1.0μH ±20% | 0.1MHz | 7100mA | 5400mA | 0.0170Ω |
| FDV0618-H-1R5N□ | 1.5μH ±30% | 0.1MHz | 6000mA | 4800mA | 0.0270Ω |
| FDV0618-H-2R2M□ | 2.2μH ±20% | 0.1MHz | 5300mA | 4400mA | 0.0340Ω |
| FDV0618-H-3R3M□ | 3.3μH ±20% | 0.1MHz | 4100mA | 3200mA | 0.0480Ω |

Absolute maximum voltage: 30V DC

Operating temp. range (Self-temp. rise included): -40 to 125°C

Class of Magnetic Shield: Metal Alloy

Only for reflow soldering

*Isat: Rated Current based on Inductance change

*Itemp: Rated Current based on Temperature rise

Rated current (Isat) is specified when the decrease of the initial inductance value at 30%. Rated current (Itemp) is specified when temperature of the inductor is raised 40°C by DC current.

Continued on the following page. ↗

Continued from the preceding page. ↘

Inductance-Current Characteristics (Typ.)



Temperature Rise Characteristics (Typ.)



FDV0620 Series 2926 (7467) inch (mm)



| Packaging Code | Packaging | Minimum Quantity |
|----------------|------------------------|------------------|
| =P3 | ø330mm Embossed Taping | 1500 |

| Part Number (□: packaging code) | Inductance | Inductance Test Frequency | Rated Current (Isat)* | Rated Current (Itemp)* | Max. of DC Resistance |
|------------------------------------|-------------|---------------------------|-----------------------|------------------------|-----------------------|
| FDV0620-H-R20M□ | 0.2µH ±20% | 0.1MHz | 16200mA | 12400mA | 0.0045Ω |
| FDV0620-H-R47M□ | 0.47µH ±20% | 0.1MHz | 11000mA | 9000mA | 0.0083Ω |
| FDV0620-H-R68M□ | 0.68µH ±20% | 0.1MHz | 10000mA | 7700mA | 0.0100Ω |
| FDV0620-H-1R0M□ | 1.0µH ±20% | 0.1MHz | 7700mA | 5700mA | 0.0180Ω |
| FDV0620-H-1R5M□ | 1.5µH ±20% | 0.1MHz | 6000mA | 5000mA | 0.0260Ω |
| FDV0620-H-2R2M□ | 2.2µH ±20% | 0.1MHz | 5100mA | 4000mA | 0.0370Ω |
| FDV0620-H-3R3M□ | 3.3µH ±20% | 0.1MHz | 4200mA | 3200mA | 0.0510Ω |
| FDV0620-H-4R7M□ | 4.7µH ±20% | 0.1MHz | 3500mA | 2800mA | 0.0680Ω |

Absolute maximum voltage: 30V DC

Operating temp. range (Self-temp. rise included): -40 to 125°C

Class of Magnetic Shield: Metal Alloy

Only for reflow soldering

*Isat: Rated Current based on Inductance change

*Itemp: Rated Current based on Temperature rise

Rated current (Isat) is specified when the decrease of the initial inductance value at 20%. Rated current (Itemp) is specified when temperature of the inductor is raised 40°C by DC current.

Inductance-Current Characteristics (Typ.)



Temperature Rise Characteristics (Typ.)



FDVE0630 Series 2926 (7467) inch (mm)



| Packaging Code | Packaging | Minimum Quantity |
|----------------|------------------------|------------------|
| =P3 | ø330mm Embossed Taping | 1000 |

| Part Number (□: packaging code) | Inductance | Inductance Test Frequency | Rated Current (Isat)* | Rated Current (Itemp)* | Max. of DC Resistance |
|------------------------------------|-------------|---------------------------|-----------------------|------------------------|-----------------------|
| FDVE0630-H-R16M□ | 0.16μH ±20% | 0.1MHz | 19400mA | 20700mA | 0.0016Ω |
| FDVE0630-H-R33M□ | 0.33μH ±20% | 0.1MHz | 15900mA | 16900mA | 0.0027Ω |
| FDVE0630-H-R47M□ | 0.47μH ±20% | 0.1MHz | 15600mA | 14100mA | 0.0037Ω |
| FDVE0630-H-R68M□ | 0.68μH ±20% | 0.1MHz | 10400mA | 11900mA | 0.0060Ω |
| FDVE0630-H-R75M□ | 0.75μH ±20% | 0.1MHz | 10900mA | 10700mA | 0.0062Ω |
| FDVE0630-H-1R0M□ | 1.0μH ±20% | 0.1MHz | 9500mA | 9500mA | 0.0085Ω |
| FDVE0630-H-1R5M□ | 1.5μH ±20% | 0.1MHz | 8100mA | 8000mA | 0.0121Ω |
| FDVE0630-H-2R2M□ | 2.2μH ±20% | 0.1MHz | 6900mA | 6600mA | 0.0162Ω |
| FDVE0630-H-3R3M□ | 3.3μH ±20% | 0.1MHz | 5300mA | 5300mA | 0.0254Ω |
| FDVE0630-H-4R7M□ | 4.7μH ±20% | 0.1MHz | 4600mA | 4400mA | 0.0361Ω |
| FDVE0630-H-6R8M□ | 6.8μH ±20% | 0.1MHz | 3400mA | 3600mA | 0.0542Ω |
| FDVE0630-H-100M□ | 10μH ±20% | 0.1MHz | 3100mA | 2800mA | 0.0792Ω |

Absolute maximum voltage: 30V DC

Operating temp. range (Self-temp. rise included): -40 to 125°C

Class of Magnetic Shield: Metal Alloy

Only for reflow soldering

*Isat: Rated Current based on Inductance change

*Itemp: Rated Current based on Temperature rise

Rated current (Isat) is specified when the decrease of the initial inductance value at 20%. Rated current (Itemp) is specified when temperature of the inductor is raised 40°C by DC current.

Inductance-Current Characteristics (Typ.)



Temperature Rise Characteristics (Typ.)



FDVE0630 Inductors for Power Lines

Inductors for General Circuits

RF Inductors

FDVE0640 Series 2926 (7467) inch (mm)



| Packaging Code | Packaging | Minimum Quantity |
|----------------|------------------------|------------------|
| =P3 | ø330mm Embossed Taping | 1000 |

| Part Number (□: packaging code) | Inductance | Inductance Test Frequency | Rated Current (Isat)* | Rated Current (Itemp)* | Max. of DC Resistance |
|------------------------------------|------------|------------------------------|-----------------------|------------------------|-----------------------|
| FDVE0640-H-1R5M□ | 1.5μH ±20% | 0.1MHz | 8000mA | 8200mA | 0.0103Ω |
| FDVE0640-H-2R2M□ | 2.2μH ±20% | 0.1MHz | 7600mA | 6500mA | 0.0163Ω |
| FDVE0640-H-3R3M□ | 3.3μH ±20% | 0.1MHz | 6000mA | 5600mA | 0.0192Ω |
| FDVE0640-H-4R7M□ | 4.7μH ±20% | 0.1MHz | 4600mA | 5000mA | 0.0292Ω |

Absolute maximum voltage: 30V DC

Operating temp. range (Self-temp. rise included): -40 to 125°C

Class of Magnetic Shield: Metal Alloy

Only for reflow soldering

*Isat: Rated Current based on Inductance change

*Itemp: Rated Current based on Temperature rise

Rated current (Isat) is specified when the decrease of the initial inductance value at 20%. Rated current (Itemp) is specified when temperature of the inductor is raised 40°C by DC current.

Inductance-Current Characteristics (Typ.)



Temperature Rise Characteristics (Typ.)



FDUE0630 Series 3026 (7667) inch (mm)



| Packaging Code | Packaging | Minimum Quantity |
|----------------|------------------------|------------------|
| =P3 | ø330mm Embossed Taping | 1000 |

Continued on the following page. ↗

Continued from the preceding page. ↘

| Part Number (□: packaging code) | Inductance | Inductance Test Frequency | Rated Current (Isat)* | Rated Current (Itemp)* | DC Resistance |
|------------------------------------|-------------|---------------------------|-----------------------|------------------------|---------------|
| FDUE0630-H-R12M□ | 0.12μH ±20% | 0.1MHz | 33000mA | 36000mA | 0.00058Ω±7% |
| FDUE0630-H-R24M□ | 0.24μH ±20% | 0.1MHz | 23000mA | 27000mA | 0.00112Ω±7% |

Absolute maximum voltage: 30V DC

Operating temp. range (Self-temp. rise included): -40 to 125°C

Class of Magnetic Shield: Metal Alloy

Only for reflow soldering

*Isat: Rated Current based on Inductance change

*Itemp: Rated Current based on Temperature rise

Rated current (Isat) is specified when the decrease of the initial inductance value at 30%. Rated current (Itemp) is specified when temperature of the inductor is raised 40°C by DC current.

Inductance-Current Characteristics (Typ.)



Temperature Rise Characteristics (Typ.)



FDUE0640 Series 3026 (7667) inch (mm)



| Packaging Code | Packaging | Minimum Quantity |
|----------------|------------------------|------------------|
| =P3 | ø330mm Embossed Taping | 1000 |

| Part Number (□: packaging code) | Inductance | Inductance Test Frequency | Rated Current (Isat)* | Rated Current (Itemp)* | DC Resistance |
|------------------------------------|-------------|---------------------------|-----------------------|------------------------|---------------|
| FDUE0640-H-KR15M□ | 0.15μH ±20% | 0.1MHz | 25000mA | 33000mA | 0.00061Ω±7% |
| FDUE0640-H-R24M□ | 0.24μH ±20% | 0.1MHz | 19000mA | 27000mA | 0.00089Ω±7% |
| FDUE0640-H-R42M□ | 0.42μH ±20% | 0.1MHz | 15000mA | 22000mA | 0.00148Ω±7% |

Absolute maximum voltage: 30V DC

Operating temp. range (Self-temp. rise included): -40 to 125°C

Class of Magnetic Shield: Metal Alloy

Only for reflow soldering

*Isat: Rated Current based on Inductance change

*Itemp: Rated Current based on Temperature rise

Rated current (Isat) is specified when the decrease of the initial inductance value at 20%. Rated current (Itemp) is specified when temperature of the inductor is raised 40°C by DC current.

Inductance-Current Characteristics (Typ.)



Temperature Rise Characteristics (Typ.)



FDUE0650 Series 3026 (7667) inch (mm)



| Packaging Code | Packaging | Minimum Quantity |
|----------------|------------------------|------------------|
| =P3 | ø330mm Embossed Taping | 1000 |

| Part Number (□: packaging code) | Terminal Dimensions |
|------------------------------------|---------------------|
| FDUE0650-H-R60M□ | A:2.7mm |
| FDUE0650-H-1R0M□ | A:2.4mm |

| Part Number (□: packaging code) | Inductance | Inductance Test Frequency | Rated Current (Isat)* | Rated Current (Itemp)* | DC Resistance |
|------------------------------------|------------|---------------------------|-----------------------|------------------------|---------------|
| FDUE0650-H-R60M□ | 0.6μH ±20% | 0.1MHz | 12000mA | 18000mA | 0.00224Ω±10% |
| FDUE0650-H-1R0M□ | 1.0μH ±20% | 0.1MHz | 9800mA | 16000mA | 0.00338Ω±10% |

Absolute maximum voltage: 30V DC

Operating temp. range (Self-temp. rise included): -40 to 125°C

Class of Magnetic Shield: Metal Alloy

Only for reflow soldering

*Isat: Rated Current based on Inductance change

*Itemp: Rated Current based on Temperature rise

Rated current (Isat) is specified when the decrease of the initial inductance value at 20%. Rated current (Itemp) is specified when temperature of the inductor is raised 40°C by DC current.

Inductance-Current Characteristics (Typ.)



Temperature Rise Characteristics (Typ.)



FDA1055 Series 4242 (108108) inch (mm)



| Packaging Code | Packaging | Minimum Quantity |
|----------------|------------------------|------------------|
| =P3 | ø330mm Embossed Taping | 500 |

| Part Number (□: packaging code) | Terminal Dimensions |
|------------------------------------|--------------------------|
| FDA1055-H-R56M□ | A:11.6mm B:1.9mm C:6.5mm |
| FDA1055-H-1R2M□ | A:11.6mm B:1.9mm C:6.5mm |
| FDA1055-H-1R5M□ | A:11.6mm B:1.9mm C:6.5mm |
| FDA1055-H-2R2M□ | A:11.4mm B:1.7mm C:6.4mm |
| FDA1055-H-3R3M□ | A:11.3mm B:1.4mm C:6.4mm |
| FDA1055-H-4R7M□ | A:11.3mm B:1.4mm C:6.4mm |
| FDA1055-H-5R6M□ | A:11.3mm B:1.4mm C:6.4mm |

Continued on the following page. ↗

Continued from the preceding page. ↘

| Part Number (□: packaging code) | Inductance | Inductance Test Frequency | Rated Current (Isat)* | Rated Current (Itemp)* | Max. of DC Resistance |
|------------------------------------|-------------|------------------------------|-----------------------|------------------------|-----------------------|
| FDA1055-H-R56M□ | 0.56μH ±20% | 0.1MHz | 27700mA | 22700mA | 0.0018Ω |
| FDA1055-H-1R2M□ | 1.2μH ±20% | 0.1MHz | 20000mA | 17900mA | 0.0029Ω |
| FDA1055-H-1R5M□ | 1.5μH ±20% | 0.1MHz | 18000mA | 16600mA | 0.0035Ω |
| FDA1055-H-2R2M□ | 2.2μH ±20% | 0.1MHz | 15500mA | 13600mA | 0.0048Ω |
| FDA1055-H-3R3M□ | 3.3μH ±20% | 0.1MHz | 11700mA | 11200mA | 0.0073Ω |
| FDA1055-H-4R7M□ | 4.7μH ±20% | 0.1MHz | 9900mA | 9100mA | 0.0110Ω |
| FDA1055-H-5R6M□ | 5.6μH ±20% | 0.1MHz | 8000mA | 7500mA | 0.0120Ω |

Absolute maximum voltage: 30V DC

Operating temp. range (Self-temp. rise included): -40 to 125°C

Class of Magnetic Shield: Metal Alloy

Only for reflow soldering

*Isat: Rated Current based on Inductance change

*Itemp: Rated Current based on Temperature rise

Rated current (Isat) is specified when the decrease of the initial inductance value at 30%. Rated current (Itemp) is specified when temperature of the inductor is raised 40°C by DC current.

Inductance-Frequency Characteristics (Typ.)



Inductance-Current Characteristics (Typ.)



Temperature Rise Characteristics (Typ.)



FDUE1040D Series 4440 (112100) inch (mm)



| Packaging Code | Packaging | Minimum Quantity |
|----------------|------------------------|------------------|
| -P3 | ø330mm Embossed Taping | 500 |

| Part Number (□: packaging code) | Inductance | Inductance Test Frequency | Rated Current (Isat)* | Rated Current (Itemp)* | DC Resistance |
|------------------------------------|-------------|------------------------------|-----------------------|------------------------|---------------|
| FDUE1040D-H-R22M□ | 0.22μH ±20% | 0.1MHz | 32000mA | 32000mA | 0.00064Ω±7% |
| FDUE1040D-H-R36M□ | 0.36μH ±20% | 0.1MHz | 25000mA | 30000mA | 0.00079Ω±7% |
| FDUE1040D-H-R45M□ | 0.45μH ±20% | 0.1MHz | 24000mA | 27000mA | 0.00102Ω±7% |
| FDUE1040D-H-R56M□ | 0.56μH ±20% | 0.1MHz | 24000mA | 25000mA | 0.00124Ω±7% |
| FDUE1040D-H-1R0M□ | 1.0μH ±20% | 0.1MHz | 16000mA | 18000mA | 0.00235Ω±7% |

Absolute maximum voltage: 30V DC

Operating temp. range (Self-temp. rise included): -40 to 125°C

Class of Magnetic Shield: Metal Alloy

Only for reflow soldering

*Isat: Rated Current based on Inductance change

*Itemp: Rated Current based on Temperature rise

Rated current (Isat) is specified when the decrease of the initial inductance value at 20%. Rated current (Itemp) is specified when temperature of the inductor is raised 40°C by DC current.

Continued on the following page. ↗

Continued from the preceding page. ↘

Inductance-Current Characteristics (Typ.)



Temperature Rise Characteristics (Typ.)



FDVE1040 Series 4440 (112100) inch (mm)



| Packaging Code | Packaging | Minimum Quantity |
|----------------|------------------------|------------------|
| =P3 | ø330mm Embossed Taping | 500 |

| Part Number (□: packaging code) | Inductance | Inductance Test Frequency | Rated Current (Isat)* | Rated Current (Itemp)* | Max. of DC Resistance |
|------------------------------------|------------|---------------------------|-----------------------|------------------------|-----------------------|
| FDVE1040-H-1R5M□ | 1.5µH ±20% | 0.1MHz | 13700mA | 14600mA | 0.0046Ω |
| FDVE1040-H-2R2M□ | 2.2µH ±20% | 0.1MHz | 11400mA | 11600mA | 0.0068Ω |
| FDVE1040-H-2R7M□ | 2.7µH ±20% | 0.1MHz | 10900mA | 10500mA | 0.0088Ω |
| FDVE1040-H-3R3M□ | 3.3µH ±20% | 0.1MHz | 9800mA | 9000mA | 0.0101Ω |
| FDVE1040-H-4R7M□ | 4.7µH ±20% | 0.1MHz | 8200mA | 8000mA | 0.0138Ω |
| FDVE1040-H-5R6M□ | 5.6µH ±20% | 0.1MHz | 7900mA | 7300mA | 0.0180Ω |
| FDVE1040-H-6R8M□ | 6.8µH ±20% | 0.1MHz | 7100mA | 7100mA | 0.0202Ω |
| FDVE1040-H-100M□ | 10µH ±20% | 0.1MHz | 6100mA | 5200mA | 0.0341Ω |

Absolute maximum voltage: 30V DC

Operating temp. range (Self-temp. rise included): -40 to 125°C

Class of Magnetic Shield: Metal Alloy

Only for reflow soldering

*Isat: Rated Current based on Inductance change

*Itemp: Rated Current based on Temperature rise

Rated current (Isat) is specified when the decrease of the initial inductance value at 20%. Rated current (Itemp) is specified when temperature of the inductor is raised 40°C by DC current.

Inductance-Current Characteristics (Typ.)



Temperature Rise Characteristics (Typ.)



FCUL1040 Series 4540 (115100) inch (mm)



| Packaging Code | Packaging | Minimum Quantity |
|----------------|------------------------|------------------|
| =P3 | ø330mm Embossed Taping | 500 |

| Part Number (□: packaging code) | Terminal Dimensions |
|------------------------------------|---------------------|
| FCUL1040-H-R18M□ | A:3.9mm |
| FCUL1040-H-R36M□ | A:3.9mm |
| FCUL1040-H-R42M□ | A:3.5mm |

| Part Number (□: packaging code) | Inductance | Inductance Test Frequency | Rated Current (Isat)* | Rated Current (Itemp)* | DC Resistance |
|------------------------------------|-------------|---------------------------|-----------------------|------------------------|---------------|
| FCUL1040-H-R18M□ | 0.18μH ±20% | 0.1MHz | 53000mA | 38000mA | 0.00054Ω±7% |
| FCUL1040-H-R36M□ | 0.36μH ±20% | 0.1MHz | 36000mA | 31000mA | 0.00082Ω±7% |
| FCUL1040-H-R42M□ | 0.42μH ±20% | 0.1MHz | 34000mA | 30000mA | 0.00102Ω±7% |

Absolute maximum voltage: 30V DC

Operating temp. range (Self-temp. rise included): -40 to 125°C

Class of Magnetic Shield: Metal Alloy

Only for reflow soldering

*Isat: Rated Current based on Inductance change

*Itemp: Rated Current based on Temperature rise

Rated current (Isat) is specified when the decrease of the initial inductance value at 30%. Rated current (Itemp) is specified when temperature of the inductor is raised 40°C by DC current.

Inductance-Frequency Characteristics (Typ.)



Inductance-Current Characteristics (Typ.)



Temperature Rise Characteristics (Typ.)



FCUL1060 Series 4640 (116100) inch (mm)



| Packaging Code | Packaging | Minimum Quantity |
|----------------|------------------------|------------------|
| =P3 | ø330mm Embossed Taping | 500 |

Continued on the following page. ↗

Continued from the preceding page. ↘

| Part Number (□: packaging code) | Inductance | Inductance Test Frequency | Rated Current (Isat)* | Rated Current (Itemp)* | DC Resistance |
|------------------------------------|-------------|---------------------------|-----------------------|------------------------|---------------|
| FCUL1060-H-R36M □ | 0.36μH ±20% | 0.1MHz | 41000mA | 41000mA | 0.00053Ω±7% |
| FCUL1060-H-R56M □ | 0.56μH ±20% | 0.1MHz | 34000mA | 30000mA | 0.00085Ω±7% |

Absolute maximum voltage: 30V DC

Operating temp. range (Self-temp. rise included): -40 to 125°C

Class of Magnetic Shield: Metal Alloy

Only for reflow soldering

*Isat: Rated Current based on Inductance change

*Itemp: Rated Current based on Temperature rise

Rated current (Isat) is specified when the decrease of the initial inductance value at 30%. Rated current (Itemp) is specified when temperature of the inductor is raised 40°C by DC current.

Inductance-Frequency Characteristics (Typ.)



Inductance-Current Characteristics (Typ.)



Temperature Rise Characteristics (Typ.)



FDUE1245 Series 4848 (123121) inch (mm)



| Packaging Code | Packaging | Minimum Quantity |
|----------------|------------------------|------------------|
| =P3 | ø330mm Embossed Taping | 500 |

| Part Number (□: packaging code) | Terminal Dimensions |
|------------------------------------|---------------------|
| FDUE1245-H-R50M □ | A:13.4mm B:2.2mm |
| FDUE1245-H-R72M □ | A:13.4mm B:2.2mm |
| FDUE1245-H-1R0M □ | A:13.2mm B:2.1mm |
| FDUE1245-H-1R5M □ | A:13.2mm B:2.1mm |
| FDUE1245-H-2R2M □ | A:13.2mm B:2.1mm |

| Part Number (□: packaging code) | Inductance | Inductance Test Frequency | Rated Current (Isat)* | Rated Current (Itemp)* | DC Resistance |
|------------------------------------|-------------|---------------------------|-----------------------|------------------------|---------------|
| FDUE1245-H-R50M □ | 0.5μH ±20% | 0.1MHz | 28000mA | 30000mA | 0.0008Ω±7% |
| FDUE1245-H-R72M □ | 0.72μH ±20% | 0.1MHz | 24000mA | 22000mA | 0.00163Ω±7% |
| FDUE1245-H-1R0M □ | 1.0μH ±20% | 0.1MHz | 21000mA | 21000mA | 0.0017Ω±7% |
| FDUE1245-H-1R5M □ | 1.5μH ±20% | 0.1MHz | 17000mA | 20000mA | 0.00226Ω±7% |
| FDUE1245-H-2R2M □ | 2.2μH ±20% | 0.1MHz | 14000mA | 17000mA | 0.0034Ω±7% |

Absolute maximum voltage: 30V DC

Operating temp. range (Self-temp. rise included): -40 to 125°C

Class of Magnetic Shield: Metal Alloy

Only for reflow soldering

*Isat: Rated Current based on Inductance change

*Itemp: Rated Current based on Temperature rise

Rated current (Isat) is specified when the decrease of the initial inductance value at 20%. Rated current (Itemp) is specified when temperature of the inductor is raised 40°C by DC current.

Continued on the following page. ↗

Continued from the preceding page. ↘

Inductance-Current Characteristics (Typ.)



Temperature Rise Characteristics (Typ.)



FDA1254 Series 5049 (126125) inch (mm)



| Packaging Code | Packaging | Minimum Quantity |
|----------------|------------------------|------------------|
| =P3 | ø330mm Embossed Taping | 500 |

| Part Number (□: packaging code) | Terminal Dimensions |
|------------------------------------|--------------------------|
| FDA1254-H-R68M□ | A:13.5mm B:1.8mm C:7.7mm |
| FDA1254-H-1R0M□ | A:13.5mm B:1.8mm C:7.7mm |
| FDA1254-H-1R2M□ | A:13.5mm B:1.8mm C:7.7mm |
| FDA1254-H-2R2M□ | A:13.2mm B:1.5mm C:7.6mm |
| FDA1254-H-3R3M□ | A:12.9mm B:1.2mm C:7.6mm |
| FDA1254-H-4R7M□ | A:12.9mm B:1.2mm C:7.6mm |
| FDA1254-H-5R6M□ | A:12.9mm B:1.2mm C:7.6mm |
| FDA1254-H-8R0M□ | A:12.9mm B:1.2mm C:7.6mm |

| Part Number (□: packaging code) | Inductance | Inductance Test Frequency | Rated Current (Isat)* | Rated Current (Itemp)* | Max. of DC Resistance |
|------------------------------------|-------------|---------------------------|-----------------------|------------------------|-----------------------|
| FDA1254-H-R68M□ | 0.68µH ±20% | 0.1MHz | 29100mA | 23700mA | 0.0015Ω |
| FDA1254-H-1R0M□ | 1.0µH ±20% | 0.1MHz | 25200mA | 20500mA | 0.0020Ω |
| FDA1254-H-1R2M□ | 1.2µH ±20% | 0.1MHz | 20200mA | 18400mA | 0.0026Ω |
| FDA1254-H-2R2M□ | 2.2µH ±20% | 0.1MHz | 14700mA | 14200mA | 0.0045Ω |
| FDA1254-H-3R3M□ | 3.3µH ±20% | 0.1MHz | 13100mA | 11500mA | 0.0070Ω |
| FDA1254-H-4R7M□ | 4.7µH ±20% | 0.1MHz | 11200mA | 10200mA | 0.0088Ω |
| FDA1254-H-5R6M□ | 5.6µH ±20% | 0.1MHz | 10800mA | 9100mA | 0.0094Ω |
| FDA1254-H-8R0M□ | 8.0µH ±20% | 0.1MHz | 9100mA | 7100mA | 0.0160Ω |

Absolute maximum voltage: 30V DC

Operating temp. range (Self-temp. rise included): -40 to 125°C

Class of Magnetic Shield: Metal Alloy

Only for reflow soldering

*Isat: Rated Current based on Inductance change

*Itemp: Rated Current based on Temperature rise

Rated current (Isat) is specified when the decrease of the initial inductance value at 30%. Rated current (Itemp) is specified when temperature of the inductor is raised 40°C by DC current.

Inductance-Current Characteristics (Typ.)



Temperature Rise Characteristics (Typ.)



FDUE1260 Series 5650 (143127) inch (mm)



| Packaging Code | Packaging | Minimum Quantity |
|----------------|------------------------|------------------|
| =P3 | ø330mm Embossed Taping | 500 |

| Part Number (□: packaging code) | Inductance | Inductance Test Frequency | Rated Current (Isat)* | Rated Current (Itemp)* | DC Resistance |
|------------------------------------|-------------|---------------------------|-----------------------|------------------------|---------------|
| FDUE1260-H-R45N□ | 0.45μH ±30% | 0.1MHz | 32000mA | 34000mA | 0.00058Ω±7% |

Absolute maximum voltage: 30V DC

Operating temp. range (Self-temp. rise included): -40 to 125°C

Class of Magnetic Shield: Metal Alloy

Only for reflow soldering

*Isat: Rated Current based on Inductance change

*Itemp: Rated Current based on Temperature rise

Rated current (Isat) is specified when the decrease of the initial inductance value at 30%. Rated current (Itemp) is specified when temperature of the inductor is raised 40°C by DC current.

Inductance-Frequency Characteristics (Typ.)



Inductance-Current Characteristics (Typ.)



Temperature Rise Characteristics (Typ.)



LQW15DN_00 Series 0402 (1005) inch (mm)

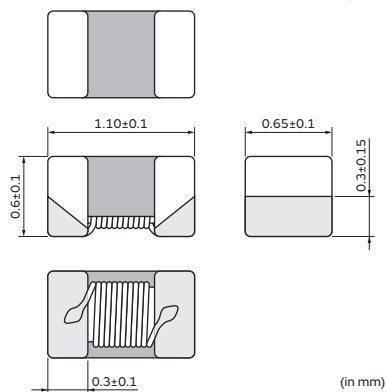

| Packaging Code | Packaging | Minimum Quantity |
|----------------|---------------------|------------------|
| D | ø180mm Paper Taping | 8000 |
| B | Packing in Bulk | 500 |

Continued on the following page. ↗

Continued from the preceding page. ↘

| Part Number (□: packaging code) | Inductance | Inductance Test Frequency | Rated Current (Isat)* | Rated Current (Itemp)* | DC Resistance | S.R.F.* (min.) |
|------------------------------------|------------|------------------------------|-----------------------|------------------------|---------------|----------------|
| LQW15DN100M00□ | 10μH ±20% | 10MHz | 120mA | 120mA | 4.7Ω±15% | 20MHz |
| LQW15DN150M00□ | 15μH ±20% | 10MHz | 100mA | 100mA | 5.7Ω±15% | 20MHz |

Operating temp. range: -40 to 85°C
 Class of Magnetic Shield: Magnetic Resin
 Only for reflow soldering

*Isat: Rated Current based on Inductance change
 *Itemp: Rated Current based on Temperature rise
 *S.R.F.: Self Resonant Frequency

When rated current is applied to the products, inductance will be within ±30% of nominal inductance value. When rated current is applied to the products, the temperature rise caused by self-generated heat shall be limited to 40°C max.

Inductance-Frequency Characteristics (Typ.)



Impedance-Frequency Characteristics (Typ.)



LQH2MCN_02 Series 0806 (2016) inch (mm)



| Packaging Code | Packaging | Minimum Quantity |
|----------------|------------------------|------------------|
| L | ø180mm Embossed Taping | 3000 |
| B | Packing in Bulk | 100 |

(in mm)

| Part Number (□: packaging code) | Inductance | Inductance Test Frequency | Rated Current | DC Resistance | S.R.F.* (min.) |
|------------------------------------|------------|------------------------------|---------------|---------------|----------------|
| LQH2MCN1R0M02□ | 1.0μH ±20% | 1MHz | 485mA | 0.30Ω±30% | 100MHz |
| LQH2MCN1R5M02□ | 1.5μH ±20% | 1MHz | 445mA | 0.40Ω±30% | 95MHz |
| LQH2MCN2R2M02□ | 2.2μH ±20% | 1MHz | 425mA | 0.48Ω±30% | 70MHz |
| LQH2MCN3R3M02□ | 3.3μH ±20% | 1MHz | 375mA | 0.60Ω±30% | 65MHz |
| LQH2MCN4R7M02□ | 4.7μH ±20% | 1MHz | 300mA | 0.8Ω±30% | 60MHz |
| LQH2MCN5R6M02□ | 5.6μH ±20% | 1MHz | 280mA | 0.9Ω±30% | 60MHz |
| LQH2MCN6R8M02□ | 6.8μH ±20% | 1MHz | 255mA | 1.0Ω±30% | 55MHz |
| LQH2MCN8R2M02□ | 8.2μH ±20% | 1MHz | 235mA | 1.1Ω±30% | 50MHz |
| LQH2MCN100K02□ | 10μH ±10% | 1MHz | 225mA | 1.2Ω±30% | 48MHz |
| LQH2MCN120K02□ | 12μH ±10% | 1MHz | 210mA | 1.4Ω±30% | 44MHz |
| LQH2MCN150K02□ | 15μH ±10% | 1MHz | 200mA | 1.6Ω±30% | 40MHz |
| LQH2MCN180K02□ | 18μH ±10% | 1MHz | 190mA | 1.8Ω±30% | 35MHz |

Operating temp. range: -40 to 85°C
 Class of Magnetic Shield: No Shield
 Only for reflow soldering

*S.R.F.: Self Resonant Frequency

When rated current is applied to the products, inductance will be within ±10% of initial inductance value. When rated current is applied to the products, the temperature rise caused by self-generated heat shall be limited to 40°C max.

Continued on the following page. ↗

Continued from the preceding page. ↘

| Part Number (□: packaging code) | Inductance | Inductance Test Frequency | Rated Current | DC Resistance | S.R.F.* (min.) |
|------------------------------------|------------|------------------------------|---------------|---------------|----------------|
| LQH2MCN220K02□ | 22μH ±10% | 1MHz | 185mA | 2.1Ω±30% | 30MHz |
| LQH2MCN270K02□ | 27μH ±10% | 1MHz | 180mA | 2.5Ω±30% | 30MHz |
| LQH2MCN330K02□ | 33μH ±10% | 1MHz | 160mA | 2.8Ω±30% | 28MHz |
| LQH2MCN390K02□ | 39μH ±10% | 1MHz | 125mA | 4.4Ω±30% | 24MHz |
| LQH2MCN470K02□ | 47μH ±10% | 1MHz | 120mA | 5.1Ω±30% | 18MHz |
| LQH2MCN560K02□ | 56μH ±10% | 1MHz | 110mA | 5.7Ω±30% | 17MHz |
| LQH2MCN680K02□ | 68μH ±10% | 1MHz | 100mA | 6.6Ω±30% | 14MHz |
| LQH2MCN820K02□ | 82μH ±10% | 1MHz | 90mA | 7.5Ω±30% | 14MHz |

Operating temp. range: -40 to 85°C

Class of Magnetic Shield: No Shield

Only for reflow soldering

*S.R.F.: Self Resonant Frequency

When rated current is applied to the products, inductance will be within ±10% of initial inductance value. When rated current is applied to the products, the temperature rise caused by self-generated heat shall be limited to 40°C max.

Inductance-Frequency Characteristics (Typ.)



Inductance-Current Characteristics (Typ.)



Temperature Rise Characteristics (Typ.)



LQH2MCN_52 Series 0806 (2016) inch (mm)



| Packaging Code | Packaging | Minimum Quantity |
|----------------|------------------------|------------------|
| L | ø180mm Embossed Taping | 3000 |
| B | Packing in Bulk | 100 |

| Part Number (□: packaging code) | Inductance | Inductance Test Frequency | Rated Current | DC Resistance | S.R.F.* (min.) |
|------------------------------------|------------|------------------------------|---------------|---------------|----------------|
| LQH2MCN1R0M52□ | 1.0μH ±20% | 1MHz | 595mA | 0.25Ω±30% | 215MHz |
| LQH2MCN1R5M52□ | 1.5μH ±20% | 1MHz | 540mA | 0.33Ω±30% | 165MHz |
| LQH2MCN2R2M52□ | 2.2μH ±20% | 1MHz | 500mA | 0.42Ω±30% | 125MHz |
| LQH2MCN3R3M52□ | 3.3μH ±20% | 1MHz | 360mA | 0.74Ω±30% | 110MHz |
| LQH2MCN4R7M52□ | 4.7μH ±20% | 1MHz | 335mA | 0.91Ω±30% | 90MHz |
| LQH2MCN6R8M52□ | 6.8μH ±20% | 1MHz | 285mA | 1.23Ω±30% | 65MHz |
| LQH2MCN100M52□ | 10μH ±20% | 1MHz | 200mA | 2.27Ω±30% | 60MHz |
| LQH2MCN120M52□ | 12μH ±20% | 1MHz | 170mA | 2.4Ω±30% | 30MHz |

Operating temp. range: -40 to 85°C

Class of Magnetic Shield: No Shield

Only for reflow soldering

*S.R.F.: Self Resonant Frequency

When rated current is applied to the products, inductance will be within ±10% of initial inductance value. When rated current is applied to the products, the temperature rise caused by self-generated heat shall be limited to 40°C max.

Continued from the preceding page. ↘

| Part Number (□: packaging code) | Inductance | Inductance Test Frequency | Rated Current | DC Resistance | S.R.F.* (min.) |
|------------------------------------|------------|------------------------------|---------------|---------------|----------------|
| LQH2MCN150M52□ | 15μH ±20% | 1MHz | 150mA | 3.5Ω±30% | 30MHz |
| LQH2MCN180M52□ | 18μH ±20% | 1MHz | 140mA | 4.0Ω±30% | 30MHz |
| LQH2MCN220M52□ | 22μH ±20% | 1MHz | 130mA | 5.5Ω±30% | 30MHz |

Operating temp. range: -40 to 85°C

Class of Magnetic Shield: No Shield

Only for reflow soldering

*S.R.F.: Self Resonant Frequency

When rated current is applied to the products, inductance will be within ±10% of initial inductance value. When rated current is applied to the products, the temperature rise caused by self-generated heat shall be limited to 40°C max.

Inductance-Frequency Characteristics (Typ.)



Inductance-Current Characteristics (Typ.)



Temperature Rise Characteristics (Typ.)



LQH2MPN_GR Series 0806 (2016) inch (mm)



| Packaging Code | Packaging | Minimum Quantity |
|----------------|------------------------|------------------|
| L | ø180mm Embossed Taping | 3000 |

| Part Number (□: packaging code) | Inductance | Inductance Test Frequency | Rated Current (I _{sat})* | Rated Current (I _{temp})* | DC Resistance | S.R.F.* (min.) |
|------------------------------------|-------------|------------------------------|------------------------------------|--|---------------|----------------|
| LQH2MPNR33NGR□ | 0.33μH ±30% | 1MHz | 2200mA | 1130mA(Ambient temp.85°C) 670mA(Ambient temp.105°C) | 0.15Ω±20% | 130MHz |
| LQH2MPNR47NGR□ | 0.47μH ±30% | 1MHz | 1950mA | 1060mA(Ambient temp.85°C) 630mA(Ambient temp.105°C) | 0.18Ω±20% | 120MHz |
| LQH2MPN1R0NGR□ | 1.0μH ±30% | 1MHz | 1550mA | 900mA(Ambient temp.85°C) 540mA(Ambient temp.105°C) | 0.25Ω±20% | 100MHz |
| LQH2MPN1R5NGR□ | 1.5μH ±30% | 1MHz | 1330mA | 790mA(Ambient temp.85°C) 470mA(Ambient temp.105°C) | 0.32Ω±20% | 60MHz |
| LQH2MPN2R2MGR□ | 2.2μH ±20% | 1MHz | 1180mA | 680mA(Ambient temp.85°C) 400mA(Ambient temp.105°C) | 0.39Ω±20% | 50MHz |

Operating temp. range (Self-temp. rise included): -40 to 125°C

Operating temp. range (Self-temp. rise not included): -40 to 105°C

Class of Magnetic Shield: Ferrite Core

Only for reflow soldering

*I_{sat}: Rated Current based on Inductance change

*I_{temp}: Rated Current based on Temperature rise

*S.R.F.: Self Resonant Frequency

When rated current is applied to the products, inductance will be within ±30% of initial inductance value range. Keep the temperature (ambient temperature plus self-generation of heat) under 125°C. When rated current is applied to the products, the self-temperature rise shall be limited to 40°C max. (ambient temperature 85°C). When rated current is applied to the products, the self-temperature rise shall be limited to 20°C max. (ambient temperature 85 °C to 105°C).

Continued on the following page. ↗

Continued from the preceding page. ↘

| Part Number (□: packaging code) | Inductance | Inductance Test Frequency | Rated Current (Isat)* | Rated Current (Itemp)* | DC Resistance | S.R.F.* (min.) |
|------------------------------------|------------|---------------------------|-----------------------|---|---------------|----------------|
| LQH2MPN3R3MGR□ | 3.3μH ±20% | 1MHz | 1020mA | 640mA(Ambient temp.85°C) 380mA(Ambient temp.105°C) | 0.47Ω±20% | 45MHz |
| LQH2MPN4R7MGR□ | 4.7μH ±20% | 1MHz | 870mA | 580mA(Ambient temp.85°C) 340mA(Ambient temp.105°C) | 0.60Ω±20% | 40MHz |
| LQH2MPN6R8MGR□ | 6.8μH ±20% | 1MHz | 730mA | 530mA(Ambient temp.85°C) 310mA(Ambient temp.105°C) | 0.72Ω±20% | 35MHz |
| LQH2MPN100MGR□ | 10μH ±20% | 1MHz | 610mA | 480mA(Ambient temp.85°C) 280mA(Ambient temp.105°C) | 0.88Ω±20% | 30MHz |
| LQH2MPN150MGR□ | 15μH ±20% | 1MHz | 490mA | 340mA(Ambient temp.85°C) 200mA(Ambient temp.105°C) | 1.7Ω±20% | 25MHz |
| LQH2MPN220MGR□ | 22μH ±20% | 1MHz | 410mA | 290mA(Ambient temp.85°C) 170mA(Ambient temp.105°C) | 2.1Ω±20% | 20MHz |
| LQH2MPN330MGR□ | 33μH ±20% | 1MHz | 310mA | 200mA(Ambient temp.85°C) 120mA(Ambient temp.105°C) | 4.3Ω±20% | 15MHz |
| LQH2MPN470MGR□ | 47μH ±20% | 1MHz | 270mA | 180mA(Ambient temp.85°C) 110mA(Ambient temp.105°C) | 5.3Ω±20% | 10MHz |
| LQH2MPN680MGR□ | 68μH ±20% | 1MHz | 230mA | 160mA(Ambient temp.85°C) 100mA(Ambient temp.105°C) | 6.7Ω±20% | 7MHz |
| LQH2MPN820MGR□ | 82μH ±20% | 1MHz | 210mA | 150mA(Ambient temp.85°C) 90mA(Ambient temp.105°C) | 7.3Ω±20% | 5MHz |

Operating temp. range (Self-temp. rise included): -40 to 125°C
 Operating temp. range (Self-temp. rise not included): -40 to 105°C
 Class of Magnetic Shield: Ferrite Core

Only for reflow soldering

*Isat: Rated Current based on Inductance change

*Itemp: Rated Current based on Temperature rise

*S.R.F.: Self Resonant Frequency

When rated current is applied to the products, inductance will be within ±30% of initial inductance value range. Keep the temperature (ambient temperature plus self-generation of heat) under 125°C. When rated current is applied to the products, the self-temperature rise shall be limited to 40°C max. (ambient temperature 85°C). When rated current is applied to the products, the self-temperature rise shall be limited to 20°C max. (ambient temperature 85 °C to 105°C).

Inductance-Frequency Characteristics (Typ.)



Inductance-Current Characteristics (Typ.)



Temperature Rise Characteristics (Typ.)



LQH2HPN_DR Series 1008 (2520) inch (mm)

LQH2HPN_DR
 Inductors for Power Lines

Inductors for General Circuits

RF Inductors



| Packaging Code | Packaging | Minimum Quantity |
|----------------|------------------------|------------------|
| L | ø180mm Embossed Taping | 4000 |

| Part Number (□: packaging code) | Inductance | Inductance Test Frequency | Rated Current (I _{sat})* | Rated Current (I _{temp})* | DC Resistance | S.R.F.* (min.) |
|------------------------------------|-------------|---------------------------|------------------------------------|--|---------------|----------------|
| LQH2HPNR47MDR□ | 0.47μH ±20% | 1MHz | 1670mA | 1250mA(Ambient temp.85°C) 750mA(Ambient temp.105°C) | 0.14Ω±20% | 120MHz |
| LQH2HPN1R0MDR□ | 1.0μH ±20% | 1MHz | 1370mA | 960mA(Ambient temp.85°C) 580mA(Ambient temp.105°C) | 0.24Ω±20% | 100MHz |
| LQH2HPN1R5MDR□ | 1.5μH ±20% | 1MHz | 1120mA | 900mA(Ambient temp.85°C) 540mA(Ambient temp.105°C) | 0.29Ω±20% | 60MHz |
| LQH2HPN2R2MDR□ | 2.2μH ±20% | 1MHz | 850mA | 820mA(Ambient temp.85°C) 500mA(Ambient temp.105°C) | 0.34Ω±20% | 50MHz |
| LQH2HPN3R3MDR□ | 3.3μH ±20% | 1MHz | 750mA | 730mA(Ambient temp.85°C) 440mA(Ambient temp.105°C) | 0.45Ω±20% | 45MHz |
| LQH2HPN4R7MDR□ | 4.7μH ±20% | 1MHz | 650mA | 650mA(Ambient temp.85°C) 390mA(Ambient temp.105°C) | 0.56Ω±20% | 40MHz |
| LQH2HPN6R8MDR□ | 6.8μH ±20% | 1MHz | 550mA | 490mA(Ambient temp.85°C) 300mA(Ambient temp.105°C) | 1.0Ω±20% | 35MHz |
| LQH2HPN100MDR□ | 10μH ±20% | 1MHz | 420mA | 430mA(Ambient temp.85°C) 260mA(Ambient temp.105°C) | 1.2Ω±20% | 30MHz |
| LQH2HPN150MDR□ | 15μH ±20% | 1MHz | 340mA | 290mA(Ambient temp.85°C) 180mA(Ambient temp.105°C) | 2.5Ω±20% | 25MHz |
| LQH2HPN220MDR□ | 22μH ±20% | 1MHz | 260mA | 270mA(Ambient temp.85°C) 170mA(Ambient temp.105°C) | 3.0Ω±20% | 20MHz |

Operating temp. range (Self-temp. rise included): -40 to 125°C
 Operating temp. range (Self-temp. rise not included): -40 to 105°C
 Class of Magnetic Shield: Magnetic Resin
 Only for reflow soldering

*I_{sat}: Rated Current based on Inductance change
 *I_{temp}: Rated Current based on Temperature rise
 *S.R.F.: Self Resonant Frequency

When rated current is applied to the products, inductance will be within ±30% of initial inductance value range. Keep the temperature (ambient temperature plus self-generation of heat) under 125°C. When rated current is applied to the products, the self-temperature rise shall be limited to 40°C max. (ambient temperature 85°C). When rated current is applied to the products, the self-temperature rise shall be limited to 20°C max. (ambient temperature 85 °C to 105°C).

Inductance-Frequency Characteristics (Typ.)

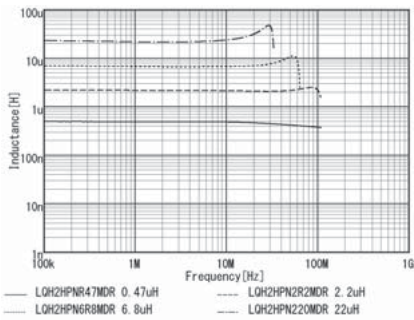

Inductance-Current Characteristics (Typ.)

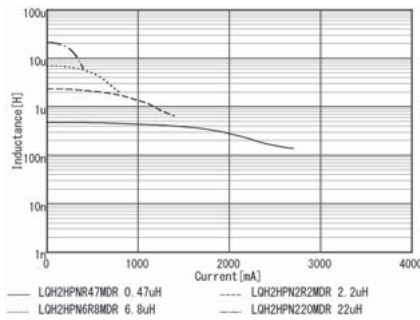

Temperature Rise Characteristics (Typ.)

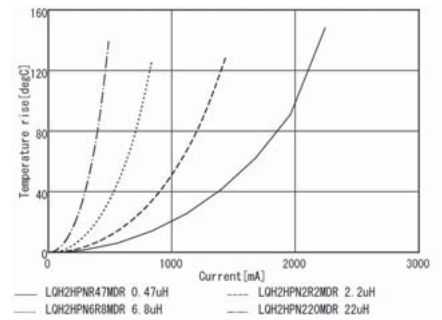

LQH2HPN_GR Series 1008 (2520) inch (mm)



(in mm)

| Packaging Code | Packaging | Minimum Quantity |
|----------------|------------------------|------------------|
| L | ø180mm Embossed Taping | 3000 |

| Part Number (□: packaging code) | Inductance | Inductance Test Frequency | Rated Current (I _{sat})* | Rated Current (I _{temp})* | DC Resistance | S.R.F.* (min.) | Operating temp. range (Self-temp. rise included) | Operating temp. range (Self-temp. rise not included) | Remark |
|------------------------------------|-------------|---------------------------|------------------------------------|---|---------------|----------------|--|--|--------|
| LQH2HPNR47MGR□ | 0.47μH ±20% | 1MHz | 2900mA | 2520mA(Ambient temp.85°C) 1470mA(Ambient temp.105°C) | 0.045Ω±20% | 120MHz | -40 to 125°C | -40 to 105°C | *1 |
| LQH2HPNR68MGR□ | 0.68μH ±20% | 1MHz | 2430mA | 2330mA(Ambient temp.85°C) 1350mA(Ambient temp.105°C) | 0.055Ω±20% | 110MHz | -40 to 125°C | -40 to 105°C | *1 |
| LQH2HPN1R0MGR□ | 1.0μH ±20% | 1MHz | 2130mA | 2100mA(Ambient temp.85°C) 1200mA(Ambient temp.105°C) | 0.068Ω±20% | 100MHz | -40 to 125°C | -40 to 105°C | *1 |
| LQH2HPN1R5MGR□ | 1.5μH ±20% | 1MHz | 1700mA | 1850mA(Ambient temp.85°C) 1110mA(Ambient temp.105°C) | 0.087Ω±20% | 90MHz | -40 to 125°C | -40 to 105°C | *1 |
| LQH2HPN2R2MGR□ | 2.2μH ±20% | 1MHz | 1550mA | 1470mA(Ambient temp.85°C) 850mA(Ambient temp.105°C) | 0.134Ω±20% | 80MHz | -40 to 125°C | -40 to 105°C | *1 |
| LQH2HPN3R3MGR□ | 3.3μH ±20% | 1MHz | 1230mA | 1100mA(Ambient temp.85°C) 660mA(Ambient temp.105°C) | 0.225Ω±20% | 70MHz | -40 to 125°C | -40 to 105°C | *1 |
| LQH2HPN4R7MGR□ | 4.7μH ±20% | 1MHz | 1090mA | 1000mA(Ambient temp.85°C) 570mA(Ambient temp.105°C) | 0.300Ω±20% | 50MHz | -40 to 125°C | -40 to 105°C | *1 |
| LQH2HPN6R8MGR□ | 6.8μH ±20% | 1MHz | 830mA | 860mA(Ambient temp.85°C) 490mA(Ambient temp.105°C) | 0.395Ω±20% | 40MHz | -40 to 125°C | -40 to 105°C | *1 |
| LQH2HPN100MGR□ | 10μH ±20% | 1MHz | 700mA | 710mA(Ambient temp.85°C) 430mA(Ambient temp.105°C) | 0.560Ω±20% | 30MHz | -40 to 125°C | -40 to 105°C | *1 |
| LQH2HPN150MGR□ | 15μH ±20% | 1MHz | 570mA | 560mA(Ambient temp.85°C) 310mA(Ambient temp.105°C) | 0.925Ω±20% | 20MHz | -40 to 125°C | -40 to 105°C | *1 |
| LQH2HPN220MGR□ | 22μH ±20% | 1MHz | 460mA | 430mA(Ambient temp.85°C) 250mA(Ambient temp.105°C) | 1.360Ω±20% | 15MHz | -40 to 125°C | -40 to 105°C | *1 |
| LQH2HPN101MGR□ | 100μH ±20% | 1MHz | 210mA | 150mA(Ambient temp.85°C) | 5.9Ω±20% | 5MHz | -40 to 105°C | -40 to 85°C | *2 |

Class of Magnetic Shield: Magnetic Resin

Only for reflow soldering

*I_{sat}: Rated Current based on Inductance change

*I_{temp}: Rated Current based on Temperature rise

*S.R.F.: Self Resonant Frequency

*1: When rated current is applied to the products, inductance will be within ±30% of initial inductance value range. Keep the temperature (ambient temperature plus self-generation of heat) under 125°C. When rated current is applied to the products, the temperature rise caused by self-generated heat shall be limited to 40°C (at the rated current under 85°C) or 20°C (at the rated current under 105°C).

*2: When rated current is applied to the products, inductance will be within ±30% of initial inductance value range. Keep the temperature (ambient temperature plus self-generation of heat) under 105°C. When rated current is applied to the products, the temperature rise caused by self-generated heat shall be limited to 20°C.

Inductance-Frequency Characteristics (Typ.)



Inductance-Current Characteristics (Typ.)



Temperature Rise Characteristics (Typ.)



LQH2HPN_JR Series 1008 (2520) inch (mm)



| Packaging Code | Packaging | Minimum Quantity |
|----------------|------------------------|------------------|
| L | ø180mm Embossed Taping | 2000 |

| Part Number (□: packaging code) | Inductance | Inductance Test Frequency | Rated Current (Isat)* | Rated Current (Itemp)* | DC Resistance | S.R.F.* (min.) |
|------------------------------------|-------------|---------------------------|-----------------------|---|---------------|----------------|
| LQH2HPNR47NJR□ | 0.47μH ±30% | 1MHz | 3500mA | 2750mA(Ambient temp.85°C) 1650mA(Ambient temp.105°C) | 0.031Ω±20% | 190MHz |
| LQH2HPN1R0NJR□ | 1.0μH ±30% | 1MHz | 2600mA | 2400mA(Ambient temp.85°C) 1440mA(Ambient temp.105°C) | 0.048Ω±20% | 120MHz |
| LQH2HPN1R2NJR□ | 1.2μH ±30% | 1MHz | 2450mA | 2070mA(Ambient temp.85°C) 1240mA(Ambient temp.105°C) | 0.055Ω±20% | 100MHz |
| LQH2HPN1R5NJR□ | 1.5μH ±30% | 1MHz | 2200mA | 1810mA(Ambient temp.85°C) 1080mA(Ambient temp.105°C) | 0.075Ω±20% | 95MHz |
| LQH2HPN2R2MJR□ | 2.2μH ±20% | 1MHz | 1700mA | 1650mA(Ambient temp.85°C) 990mA(Ambient temp.105°C) | 0.092Ω±20% | 50MHz |
| LQH2HPN3R3MJR□ | 3.3μH ±20% | 1MHz | 1450mA | 1420mA(Ambient temp.85°C) 850mA(Ambient temp.105°C) | 0.13Ω±20% | 45MHz |
| LQH2HPN4R7MJR□ | 4.7μH ±20% | 1MHz | 1230mA | 1290mA(Ambient temp.85°C) 770mA(Ambient temp.105°C) | 0.17Ω±20% | 40MHz |
| LQH2HPN6R8MJR□ | 6.8μH ±20% | 1MHz | 1050mA | 1000mA(Ambient temp.85°C) 600mA(Ambient temp.105°C) | 0.26Ω±20% | 35MHz |
| LQH2HPN100MJR□ | 10μH ±20% | 1MHz | 830mA | 830mA(Ambient temp.85°C) 490mA(Ambient temp.105°C) | 0.38Ω±20% | 30MHz |
| LQH2HPN150MJR□ | 15μH ±20% | 1MHz | 690mA | 710mA(Ambient temp.85°C) 420mA(Ambient temp.105°C) | 0.55Ω±20% | 20MHz |
| LQH2HPN220MJR□ | 22μH ±20% | 1MHz | 530mA | 540mA(Ambient temp.85°C) 320mA(Ambient temp.105°C) | 0.84Ω±20% | 20MHz |

Operating temp. range (Self-temp. rise included): -40 to 125°C
 Operating temp. range (Self-temp. rise not included): -40 to 105°C
 Class of Magnetic Shield: Magnetic Resin
 Only for reflow soldering

*Isat: Rated Current based on Inductance change
 *Itemp: Rated Current based on Temperature rise
 *S.R.F.: Self Resonant Frequency

When rated current is applied to the products, inductance will be within ±30% of initial inductance value range. Keep the temperature (ambient temperature plus self-generation of heat) under 125°C. When rated current is applied to the products, the self-temperature rise shall be limited to 40°C max. (ambient temperature 85°C). When rated current is applied to the products, the self-temperature rise shall be limited to 20°C max. (ambient temperature 85 °C to 105°C).

Inductance-Frequency Characteristics (Typ.)



Inductance-Current Characteristics (Typ.)



Temperature Rise Characteristics (Typ.)



LQH31CN_03 Series 1206 (3216) inch (mm)



| Packaging Code | Packaging | Minimum Quantity |
|----------------|------------------------|------------------|
| K | ø330mm Embossed Taping | 7500 |
| L | ø180mm Embossed Taping | 2000 |

| Part Number (□: packaging code) | Inductance | Inductance Test Frequency | Rated Current | DC Resistance | S.R.F.* (min.) |
|------------------------------------|-------------|---------------------------|---------------|---------------|----------------|
| LQH31CNR12M03□ | 0.12μH ±20% | 1MHz | 970mA | 0.08Ω±40% | 250MHz |
| LQH31CNR22M03□ | 0.22μH ±20% | 1MHz | 850mA | 0.10Ω±40% | 250MHz |
| LQH31CNR47M03□ | 0.47μH ±20% | 1MHz | 700mA | 0.15Ω±40% | 180MHz |
| LQH31CN1R0M03□ | 1.0μH ±20% | 1MHz | 510mA | 0.28Ω±30% | 100MHz |
| LQH31CN2R2M03□ | 2.2μH ±20% | 1MHz | 430mA | 0.41Ω±30% | 50MHz |
| LQH31CN4R7M03□ | 4.7μH ±20% | 1MHz | 340mA | 0.65Ω±30% | 31MHz |
| LQH31CN100K03□ | 10μH ±10% | 1MHz | 230mA | 1.3Ω±30% | 20MHz |
| LQH31CN220K03□ | 22μH ±10% | 1MHz | 160mA | 3.0Ω±30% | 14MHz |
| LQH31CN470K03□ | 47μH ±10% | 1MHz | 100mA | 8.0Ω±30% | 10MHz |
| LQH31CN101K03□ | 100μH ±10% | 1MHz | 80mA | 12.0Ω±30% | 7MHz |

Operating temp. range: -40 to 85°C

Class of Magnetic Shield: No Shield

*S.R.F.: Self Resonant Frequency

When rated current is applied to the products, inductance will be within ±10% of initial inductance value. When rated current is applied to the products, the temperature rise caused by self-generated heat shall be limited to 35°C max.

Inductance-Frequency Characteristics (Typ.)



Inductance-Current Characteristics (Typ.)



Impedance-Frequency Characteristics (Typ.)



LQH32CN_23 Series 1210 (3225) inch (mm)



| Packaging Code | Packaging | Minimum Quantity |
|----------------|------------------------|------------------|
| K | ø330mm Embossed Taping | 7500 |
| L | ø180mm Embossed Taping | 2000 |

Continued on the following page. ↗

Continued from the preceding page. ↘

| Part Number (□: packaging code) | Inductance | Inductance Test Frequency | Rated Current | DC Resistance | S.R.F.* (min.) |
|------------------------------------|------------|------------------------------|---------------|---------------|----------------|
| LQH32CN1R0M23□ | 1.0μH ±20% | 1MHz | 800mA | 0.09Ω±30% | 96MHz |
| LQH32CN2R2M23□ | 2.2μH ±20% | 1MHz | 600mA | 0.13Ω±30% | 64MHz |
| LQH32CN4R7M23□ | 4.7μH ±20% | 1MHz | 450mA | 0.2Ω±30% | 43MHz |
| LQH32CN100K23□ | 10μH ±10% | 1MHz | 300mA | 0.44Ω±30% | 26MHz |
| LQH32CN220K23□ | 22μH ±10% | 1MHz | 250mA | 0.71Ω±30% | 19MHz |
| LQH32CN470K23□ | 47μH ±10% | 1MHz | 170mA | 1.3Ω±30% | 15MHz |
| LQH32CN101K23□ | 100μH ±10% | 1MHz | 100mA | 3.5Ω±30% | 10MHz |
| LQH32CN221K23□ | 220μH ±10% | 1MHz | 70mA | 8.4Ω±30% | 6.8MHz |
| LQH32CN331K23□ | 330μH ±10% | 1MHz | 60mA | 10.0Ω±30% | 5.6MHz |
| LQH32CN391K23□ | 390μH ±10% | 1MHz | 60mA | 17Ω±30% | 5.0MHz |
| LQH32CN471K23□ | 470μH ±10% | 1kHz | 60mA | 19Ω±30% | 5.0MHz |
| LQH32CN561K23□ | 560μH ±10% | 1kHz | 60mA | 22.0Ω±30% | 5.0MHz |

Operating temp. range: -40 to 85°C

Class of Magnetic Shield: No Shield

*S.R.F.: Self Resonant Frequency

When rated current is applied to the products, self-temperature rise shall be limited to 20°C max and inductance will be within ±10% of initial inductance value.

Inductance-Frequency Characteristics (Typ.)



Inductance-Current Characteristics (Typ.)



Impedance-Frequency Characteristics (Typ.)



LQH32CN_33 Series 1210 (3225) inch (mm)



| Packaging Code | Packaging | Minimum Quantity |
|----------------|------------------------|------------------|
| K | ø330mm Embossed Taping | 7500 |
| L | ø180mm Embossed Taping | 2000 |

| Part Number (□: packaging code) | Inductance | Inductance Test Frequency | Rated Current | DC Resistance | S.R.F.* (min.) |
|------------------------------------|-------------|------------------------------|---------------|---------------|----------------|
| LQH32CNR15M33□ | 0.15μH ±20% | 1MHz | 1450mA | 0.028Ω±30% | 400MHz |
| LQH32CNR27M33□ | 0.27μH ±20% | 1MHz | 1250mA | 0.034Ω±30% | 250MHz |
| LQH32CNR47M33□ | 0.47μH ±20% | 1MHz | 1100mA | 0.042Ω±30% | 150MHz |
| LQH32CN1R0M33□ | 1.0μH ±20% | 1MHz | 1000mA | 0.06Ω±30% | 100MHz |
| LQH32CN2R2M33□ | 2.2μH ±20% | 1MHz | 790mA | 0.097Ω±30% | 64MHz |
| LQH32CN4R7M33□ | 4.7μH ±20% | 1MHz | 650mA | 0.15Ω±30% | 43MHz |
| LQH32CN100K33□ | 10μH ±10% | 1MHz | 450mA | 0.3Ω±30% | 26MHz |

Operating temp. range: -40 to 85°C

Class of Magnetic Shield: No Shield

*S.R.F.: Self Resonant Frequency

When rated current is applied to the products, self-temperature rise shall be limited to 20°C max and inductance will be within ±10% of initial inductance value.

Continued on the following page. ↗

Continued from the preceding page. ↘

Inductance-Frequency Characteristics (Typ.)



Inductance-Current Characteristics (Typ.)



Impedance-Frequency Characteristics (Typ.)



LQH32CN_53 Series 1210 (3225) inch (mm)



Marking of inductance letter is available. (optional)



0.9±0.3 (in mm)

| Packaging Code | Packaging | Minimum Quantity |
|----------------|------------------------|------------------|
| K | ø330mm Embossed Taping | 7500 |
| L | ø180mm Embossed Taping | 2000 |

| Part Number (□: packaging code) | Inductance | Inductance Test Frequency | Rated Current | DC Resistance | S.R.F.* (min.) |
|------------------------------------|------------|---------------------------|---------------|---------------|----------------|
| LQH32CN1R0M53□ | 1.0μH ±20% | 1MHz | 1000mA | 0.060Ω±30% | 100MHz |
| LQH32CN2R2M53□ | 2.2μH ±20% | 1MHz | 790mA | 0.097Ω±30% | 64MHz |
| LQH32CN3R3M53□ | 3.3μH ±20% | 1MHz | 710mA | 0.12Ω±30% | 50MHz |
| LQH32CN4R7M53□ | 4.7μH ±20% | 1MHz | 650mA | 0.15Ω±30% | 43MHz |
| LQH32CN6R8M53□ | 6.8μH ±20% | 1MHz | 540mA | 0.25Ω±30% | 32MHz |
| LQH32CN100K53□ | 10μH ±10% | 1MHz | 450mA | 0.30Ω±30% | 26MHz |
| LQH32CN150K53□ | 15μH ±10% | 1MHz | 300mA | 0.58Ω±30% | 26MHz |
| LQH32CN220K53□ | 22μH ±10% | 1MHz | 250mA | 0.71Ω±30% | 19MHz |
| LQH32CN330K53□ | 33μH ±10% | 1MHz | 200mA | 1.1Ω±30% | 17MHz |
| LQH32CN470K53□ | 47μH ±10% | 1MHz | 170mA | 1.3Ω±30% | 15MHz |
| LQH32CN680K53□ | 68μH ±10% | 1MHz | 130mA | 2.2Ω±30% | 12MHz |
| LQH32CN101K53□ | 100μH ±10% | 1MHz | 100mA | 3.5Ω±30% | 10MHz |

Operating temp. range: -40 to 85°C

Class of Magnetic Shield: No Shield

*S.R.F.: Self Resonant Frequency

When rated current is applied to the products, self-temperature rise shall be limited to 20°C max and inductance will be within ±10% of initial inductance value.

Inductance-Frequency Characteristics (Typ.)



Inductance-Current Characteristics (Typ.)



Impedance-Frequency Characteristics (Typ.)



LQH32DN_23 Series 1210 (3225) inch (mm)



| Packaging Code | Packaging | Minimum Quantity |
|----------------|------------------------|------------------|
| K | ø330mm Embossed Taping | 7500 |
| L | ø180mm Embossed Taping | 2000 |

| Part Number (□: packaging code) | Inductance | Inductance Test Frequency | Rated Current | DC Resistance | S.R.F.* (min.) | Operating temp. range |
|------------------------------------|------------|---------------------------|---------------|---------------|----------------|-----------------------|
| LQH32DN1R0M23□ | 1.0μH ±20% | 1MHz | 800mA | 0.09Ω±30% | 96MHz | -40 to 105°C |
| LQH32DN2R2M23□ | 2.2μH ±20% | 1MHz | 600mA | 0.13Ω±30% | 64MHz | -40 to 105°C |
| LQH32DN3R3M23□ | 3.3μH ±20% | 1MHz | 530mA | 0.20Ω±30% | 50MHz | -40 to 105°C |
| LQH32DN4R7M23□ | 4.7μH ±20% | 1MHz | 450mA | 0.20Ω±30% | 43MHz | -40 to 105°C |
| LQH32DN100K23□ | 10μH ±10% | 1MHz | 300mA | 0.44Ω±30% | 26MHz | -40 to 105°C |
| LQH32DN220K23□ | 22μH ±10% | 1MHz | 250mA | 0.71Ω±30% | 19MHz | -40 to 105°C |
| LQH32DN390K23□ | 39μH ±10% | 1MHz | 200mA | 1.2Ω±30% | 16MHz | -40 to 105°C |
| LQH32DN470K23□ | 47μH ±10% | 1MHz | 170mA | 1.3Ω±30% | 15MHz | -40 to 105°C |
| LQH32DN680K23□ | 68μH ±10% | 1MHz | 130mA | 2.2Ω±30% | 12MHz | -40 to 105°C |
| LQH32DN101K23□ | 100μH ±10% | 1MHz | 100mA | 3.5Ω±30% | 10MHz | -40 to 105°C |
| LQH32DN151K23□ | 150μH ±10% | 1MHz | 80mA | 5.1Ω±30% | 8.0MHz | -40 to 105°C |
| LQH32DN221K23□ | 220μH ±10% | 1MHz | 70mA | 8.4Ω±30% | 6.8MHz | -40 to 105°C |
| LQH32DN331K23□ | 330μH ±10% | 1MHz | 60mA | 10.0Ω±30% | 5.6MHz | -40 to 105°C |
| LQH32DN391K23□ | 390μH ±10% | 1MHz | 60mA | 17Ω±30% | 5MHz | -40 to 85°C |
| LQH32DN471K23□ | 470μH ±10% | 1kHz | 60mA | 19Ω±30% | 5MHz | -40 to 85°C |
| LQH32DN561K23□ | 560μH ±10% | 1kHz | 60mA | 22Ω±30% | 5MHz | -40 to 85°C |

Class of Magnetic Shield: No Shield
 Only for reflow soldering
 *S.R.F.: Self Resonant Frequency

When rated current is applied to the products, self-temperature rise shall be limited to 20°C max and inductance will be within ±10% of initial inductance value.

Inductance-Frequency Characteristics (Typ.)



Inductance-Current Characteristics (Typ.)



Impedance-Frequency Characteristics (Typ.)



LQH32DN_23 Inductors for Power Lines

Inductors for General Circuits

RF Inductors

LQH32DN_53 Series 1210 (3225) inch (mm)



| Packaging Code | Packaging | Minimum Quantity |
|----------------|------------------------|------------------|
| K | ø330mm Embossed Taping | 7500 |
| L | ø180mm Embossed Taping | 2000 |

| Part Number (□: packaging code) | Inductance | Inductance Test Frequency | Rated Current | DC Resistance | S.R.F.* (min.) |
|------------------------------------|------------|---------------------------|---------------|---------------|----------------|
| LQH32DN1R0M53□ | 1.0μH ±20% | 1MHz | 1000mA | 0.060Ω±30% | 100MHz |
| LQH32DN2R2M53□ | 2.2μH ±20% | 1MHz | 790mA | 0.097Ω±30% | 64MHz |
| LQH32DN3R3M53□ | 3.3μH ±20% | 1MHz | 710mA | 0.12Ω±30% | 50MHz |
| LQH32DN4R7M53□ | 4.7μH ±20% | 1MHz | 650mA | 0.15Ω±30% | 43MHz |
| LQH32DN6R8M53□ | 6.8μH ±20% | 1MHz | 540mA | 0.25Ω±30% | 32MHz |
| LQH32DN100K53□ | 10μH ±10% | 1MHz | 450mA | 0.30Ω±30% | 26MHz |
| LQH32DN150K53□ | 15μH ±10% | 1MHz | 300mA | 0.58Ω±30% | 26MHz |
| LQH32DN220K53□ | 22μH ±10% | 1MHz | 250mA | 0.71Ω±30% | 19MHz |
| LQH32DN330K53□ | 33μH ±10% | 1MHz | 200mA | 1.1Ω±30% | 17MHz |
| LQH32DN470K53□ | 47μH ±10% | 1MHz | 170mA | 1.3Ω±30% | 15MHz |
| LQH32DN680K53□ | 68μH ±10% | 1MHz | 130mA | 2.2Ω±30% | 12MHz |
| LQH32DN101K53□ | 100μH ±10% | 1MHz | 100mA | 3.5Ω±30% | 10MHz |

Operating temp. range: -40 to 105°C
 Class of Magnetic Shield: No Shield
 Only for reflow soldering

*S.R.F.: Self Resonant Frequency

When rated current is applied to the products, self-temperature rise shall be limited to 20°C max and inductance will be within ±10% of initial inductance value.

Inductance-Frequency Characteristics (Typ.)



Inductance-Current Characteristics (Typ.)



Impedance-Frequency Characteristics (Typ.)



LQH32PB_N0 Series 1210 (3225) inch (mm)



| Packaging Code | Packaging | Minimum Quantity |
|----------------|------------------------|------------------|
| K | ø330mm Embossed Taping | 7500 |
| L | ø180mm Embossed Taping | 2000 |
| B | Packing in Bulk | 500 |

(in mm)

| Part Number (□: packaging code) | Inductance | Inductance Test Frequency | Rated Current (Isat)* | Rated Current (Itemp)* | DC Resistance | S.R.F.* (min.) |
|------------------------------------|-------------|---------------------------|-----------------------|---|---------------|----------------|
| LQH32PBR47NNO□ | 0.47µH ±30% | 1MHz | 3400mA | 2550mA(Ambient temp.85°C) 1600mA(Ambient temp.105°C) | 0.030Ω±20% | 100MHz |
| LQH32PB1R0NNO□ | 1.0µH ±30% | 1MHz | 2300mA | 2050mA(Ambient temp.85°C) 1320mA(Ambient temp.105°C) | 0.045Ω±20% | 100MHz |
| LQH32PB1R5NNO□ | 1.5µH ±30% | 1MHz | 1750mA | 1750mA(Ambient temp.85°C) 1010mA(Ambient temp.105°C) | 0.057Ω±20% | 70MHz |
| LQH32PB2R2NNO□ | 2.2µH ±30% | 1MHz | 1550mA | 1600mA(Ambient temp.85°C) 970mA(Ambient temp.105°C) | 0.076Ω±20% | 70MHz |
| LQH32PB3R3NNO□ | 3.3µH ±30% | 1MHz | 1250mA | 1200mA(Ambient temp.85°C) 670mA(Ambient temp.105°C) | 0.12Ω±20% | 50MHz |
| LQH32PB4R7NNO□ | 4.7µH ±30% | 1MHz | 1000mA | 1000mA(Ambient temp.85°C) 530mA(Ambient temp.105°C) | 0.18Ω±20% | 40MHz |
| LQH32PB6R8NNO□ | 6.8µH ±30% | 1MHz | 850mA | 850mA(Ambient temp.85°C) 510mA(Ambient temp.105°C) | 0.24Ω±20% | 40MHz |
| LQH32PB100MNNO□ | 10µH ±20% | 1MHz | 750mA | 700mA(Ambient temp.85°C) 380mA(Ambient temp.105°C) | 0.38Ω±20% | 30MHz |
| LQH32PB150MNNO□ | 15µH ±20% | 1MHz | 600mA | 520mA(Ambient temp.85°C) 320mA(Ambient temp.105°C) | 0.57Ω±20% | 20MHz |
| LQH32PB220MNNO□ | 22µH ±20% | 1MHz | 500mA | 450mA(Ambient temp.85°C) 240mA(Ambient temp.105°C) | 0.81Ω±20% | 20MHz |
| LQH32PB330MNNO□ | 33µH ±20% | 1MHz | 380mA | 390mA(Ambient temp.85°C) 190mA(Ambient temp.105°C) | 1.15Ω±20% | 13MHz |
| LQH32PB470MNNO□ | 47µH ±20% | 1MHz | 330mA | 310mA(Ambient temp.85°C) 140mA(Ambient temp.105°C) | 1.78Ω±20% | 11MHz |
| LQH32PB680MNNO□ | 68µH ±20% | 1MHz | 280mA | 275mA(Ambient temp.85°C) 120mA(Ambient temp.105°C) | 2.28Ω±20% | 11MHz |
| LQH32PB101MNNO□ | 100µH ±20% | 1MHz | 180mA | 250mA(Ambient temp.85°C) 110mA(Ambient temp.105°C) | 2.70Ω±20% | 8MHz |
| LQH32PB121MNNO□ | 120µH ±20% | 1MHz | 170mA | 200mA(Ambient temp.85°C) 80mA(Ambient temp.105°C) | 4.38Ω±20% | 8MHz |

Operating temp. range (Self-temp. rise included): -40 to 125°C
 Operating temp. range (Self-temp. rise not included): -40 to 105°C
 Class of Magnetic Shield: Magnetic Resin

Only for reflow soldering
 *Isat: Rated Current based on Inductance change
 *Itemp: Rated Current based on Temperature rise
 *S.R.F.: Self Resonant Frequency

When rated current is applied to the products, inductance will be within ±30% of nominal inductance value. When rated current is applied to the products, the temperature rise caused by self-generated heat shall be limited to 40°C max. Keep the temperature (ambient temperature plus self-generation of heat) under 125°C.

Continued on the following page. ↗

LQH32PB_N0 Inductors for Power Lines

Inductors for General Circuits

RF Inductors

Continued from the preceding page. ↘

Inductance-Frequency Characteristics (Typ.)



Inductance-Current Characteristics (Typ.)



Temperature Rise Characteristics (Typ.)



LQH32PB_NC Series 1210 (3225) inch (mm)

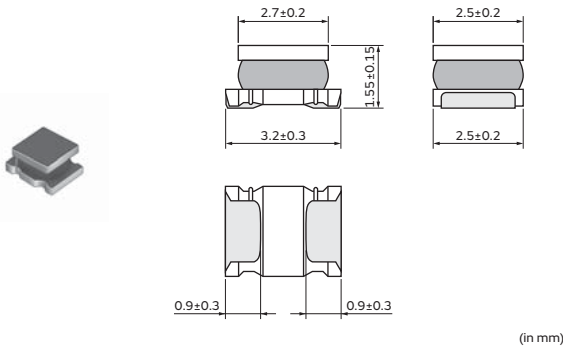

| Packaging Code | Packaging | Minimum Quantity |
|----------------|------------------------|------------------|
| K | ø330mm Embossed Taping | 7500 |
| L | ø180mm Embossed Taping | 2000 |
| B | Packing in Bulk | 500 |

| Part Number (□: packaging code) | Inductance | Inductance Test Frequency | Rated Current (Isat)* | Rated Current (Itemp)* | DC Resistance | S.R.F.* (min.) |
|------------------------------------|-------------|---------------------------|-----------------------|---|---------------|----------------|
| LQH32PBR47NNC□ | 0.47µH ±30% | 1MHz | 4400mA | 2900mA(Ambient temp.85°C) 1490mA(Ambient temp.105°C) | 0.024Ω±20% | 100MHz |
| LQH32PB1R0NNC□ | 1.0µH ±30% | 1MHz | 3000mA | 2500mA(Ambient temp.85°C) 1380mA(Ambient temp.105°C) | 0.036Ω±20% | 100MHz |
| LQH32PB1R5NNC□ | 1.5µH ±30% | 1MHz | 2600mA | 2100mA(Ambient temp.85°C) 1110mA(Ambient temp.105°C) | 0.053Ω±20% | 70MHz |
| LQH32PB2R2NNC□ | 2.2µH ±30% | 1MHz | 2000mA | 1850mA(Ambient temp.85°C) 910mA(Ambient temp.105°C) | 0.064Ω±20% | 70MHz |
| LQH32PB3R3NNC□ | 3.3µH ±30% | 1MHz | 1900mA | 1550mA(Ambient temp.85°C) 800mA(Ambient temp.105°C) | 0.100Ω±20% | 50MHz |
| LQH32PB4R7NNC□ | 4.7µH ±30% | 1MHz | 1600mA | 1200mA(Ambient temp.85°C) 610mA(Ambient temp.105°C) | 0.155Ω±20% | 40MHz |
| LQH32PB6R8NNC□ | 6.8µH ±30% | 1MHz | 1300mA | 1100mA(Ambient temp.85°C) 550mA(Ambient temp.105°C) | 0.220Ω±20% | 40MHz |
| LQH32PB100MNC□ | 10µH ±20% | 1MHz | 1000mA | 900mA(Ambient temp.85°C) 450mA(Ambient temp.105°C) | 0.295Ω±20% | 30MHz |
| LQH32PB150MNC□ | 15µH ±20% | 1MHz | 800mA | 700mA(Ambient temp.85°C) 330mA(Ambient temp.105°C) | 0.475Ω±20% | 20MHz |
| LQH32PB220MNC□ | 22µH ±20% | 1MHz | 650mA | 550mA(Ambient temp.85°C) 270mA(Ambient temp.105°C) | 0.685Ω±20% | 20MHz |

Operating temp. range (Self-temp. rise included): -40 to 125°C
 Operating temp. range (Self-temp. rise not included): -40 to 105°C
 Class of Magnetic Shield: Magnetic Resin

Only for reflow soldering

*Isat: Rated Current based on Inductance change

*Itemp: Rated Current based on Temperature rise

*S.R.F.: Self Resonant Frequency

When rated current is applied to the products, inductance will be within ±30% of nominal inductance value. When rated current is applied to the products, the temperature rise caused by self-generated heat shall be limited to 40°C max. Keep the temperature (ambient temperature plus self-generation of heat) under 125°C.

Continued on the following page. ↗

Inductors for Power Lines LQH32PB_NC
 Inductors for General Circuits
 RF Inductors

Continued from the preceding page. ↘

Inductance-Frequency Characteristics (Typ.)



Inductance-Current Characteristics (Typ.)



Temperature Rise Characteristics (Typ.)



LQH32PN_NO Series 1210 (3225) inch (mm)



| Packaging Code | Packaging | Minimum Quantity |
|----------------|------------------------|------------------|
| K | ø330mm Embossed Taping | 7500 |
| L | ø180mm Embossed Taping | 2000 |
| B | Packing in Bulk | 500 |

| Part Number (□: packaging code) | Inductance | Inductance Test Frequency | Rated Current (Isat)* | Rated Current (Itemp)* | DC Resistance | S.R.F.* (min.) |
|------------------------------------|-------------|---------------------------|-----------------------|------------------------|---------------|----------------|
| LQH32PNR47NNO□ | 0.47µH ±30% | 1MHz | 3400mA | 2550mA | 0.030Ω±20% | 100MHz |
| LQH32PN1R0NNO□ | 1.0µH ±30% | 1MHz | 2300mA | 2050mA | 0.045Ω±20% | 100MHz |
| LQH32PN1R5NNO□ | 1.5µH ±30% | 1MHz | 1750mA | 1750mA | 0.057Ω±20% | 70MHz |
| LQH32PN2R2NNO□ | 2.2µH ±30% | 1MHz | 1550mA | 1600mA | 0.076Ω±20% | 70MHz |
| LQH32PN3R3NNO□ | 3.3µH ±30% | 1MHz | 1250mA | 1200mA | 0.12Ω±20% | 50MHz |
| LQH32PN4R7NNO□ | 4.7µH ±30% | 1MHz | 1000mA | 1000mA | 0.18Ω±20% | 40MHz |
| LQH32PN6R8NNO□ | 6.8µH ±30% | 1MHz | 850mA | 850mA | 0.24Ω±20% | 40MHz |
| LQH32PN100MN0□ | 10µH ±20% | 1MHz | 750mA | 700mA | 0.38Ω±20% | 30MHz |
| LQH32PN150MN0□ | 15µH ±20% | 1MHz | 600mA | 520mA | 0.57Ω±20% | 20MHz |
| LQH32PN220MN0□ | 22µH ±20% | 1MHz | 500mA | 450mA | 0.81Ω±20% | 20MHz |
| LQH32PN330MN0□ | 33µH ±20% | 1MHz | 380mA | 390mA | 1.15Ω±20% | 13MHz |
| LQH32PN470MN0□ | 47µH ±20% | 1MHz | 330mA | 310mA | 1.78Ω±20% | 11MHz |
| LQH32PN680MN0□ | 68µH ±20% | 1MHz | 280mA | 275mA | 2.28Ω±20% | 11MHz |
| LQH32PN101MN0□ | 100µH ±20% | 1MHz | 180mA | 250mA | 2.70Ω±20% | 8MHz |
| LQH32PN121MN0□ | 120µH ±20% | 1MHz | 170mA | 200mA | 4.38Ω±20% | 8MHz |

Operating temp. range (Self-temp. rise included): -40 to 125°C
 Operating temp. range (Self-temp. rise not included): -40 to 85°C
 Class of Magnetic Shield: Magnetic Resin

Only for reflow soldering
 *Isat: Rated Current based on Inductance change
 *Itemp: Rated Current based on Temperature rise
 *S.R.F.: Self Resonant Frequency

When rated current is applied to the products, inductance will be within ±30% of nominal inductance value. When rated current is applied to the products, the temperature rise caused by self-generated heat shall be limited to 40°C max. Keep the temperature (ambient temperature plus self-generation of heat) under 125°C.

Continued on the following page. ↗

LQH32PN_NO Inductors for Power Lines

Inductors for General Circuits

RF Inductors

Continued from the preceding page. ↘

Inductance-Frequency Characteristics (Typ.)



Inductance-Current Characteristics (Typ.)



Temperature Rise Characteristics (Typ.)



LQH32PN_NC Series 1210 (3225) inch (mm)



| Packaging Code | Packaging | Minimum Quantity |
|----------------|------------------------|------------------|
| K | ø330mm Embossed Taping | 7500 |
| L | ø180mm Embossed Taping | 2000 |

| Part Number (□: packaging code) | Inductance | Inductance Test Frequency | Rated Current (Isat)* | Rated Current (Itemp)* | DC Resistance | S.R.F.* (min.) |
|------------------------------------|-------------|---------------------------|-----------------------|------------------------|---------------|----------------|
| LQH32PNR47NNC□ | 0.47μH ±30% | 1MHz | 4400mA | 2900mA | 0.024Ω±20% | 100MHz |
| LQH32PN1R0NNC□ | 1.0μH ±30% | 1MHz | 3000mA | 2500mA | 0.036Ω±20% | 100MHz |
| LQH32PN1R5NNC□ | 1.5μH ±30% | 1MHz | 2600mA | 2100mA | 0.053Ω±20% | 70MHz |
| LQH32PN2R2NNC□ | 2.2μH ±30% | 1MHz | 2000mA | 1850mA | 0.064Ω±20% | 70MHz |
| LQH32PN3R3NNC□ | 3.3μH ±30% | 1MHz | 1900mA | 1550mA | 0.100Ω±20% | 50MHz |
| LQH32PN4R7NNC□ | 4.7μH ±30% | 1MHz | 1600mA | 1200mA | 0.155Ω±20% | 40MHz |
| LQH32PN6R8NNC□ | 6.8μH ±30% | 1MHz | 1300mA | 1100mA | 0.220Ω±20% | 40MHz |
| LQH32PN100MNC□ | 10μH ±20% | 1MHz | 1000mA | 900mA | 0.295Ω±20% | 30MHz |
| LQH32PN150MNC□ | 15μH ±20% | 1MHz | 800mA | 700mA | 0.475Ω±20% | 20MHz |
| LQH32PN220MNC□ | 22μH ±20% | 1MHz | 650mA | 550mA | 0.685Ω±20% | 20MHz |

Operating temp. range (Self-temp. rise included): -40 to 125°C
 Operating temp. range (Self-temp. rise not included): -40 to 85°C
 Class of Magnetic Shield: Magnetic Resin

Only for reflow soldering

*Isat: Rated Current based on Inductance change

*Itemp: Rated Current based on Temperature rise

*S.R.F.: Self Resonant Frequency

When rated current is applied to the products, inductance will be within ±30% of nominal inductance value. When rated current is applied to the products, the temperature rise caused by self-generated heat shall be limited to 40°C max. Keep the temperature (ambient temperature plus self-generation of heat) under 125°C.

Inductance-Frequency Characteristics (Typ.)



Inductance-Current Characteristics (Typ.)



Temperature Rise Characteristics (Typ.)



DEM2812C Series 1211 (3028) inch (mm)



| Packaging Code | Packaging | Minimum Quantity |
|----------------|------------------------|------------------|
| =P2 | ø180mm Embossed Taping | 2000 |

| Part Number (□: packaging code) | Inductance | Inductance Test Frequency | Rated Current (Isat)* | Rated Current (Itemp)* | DC Resistance |
|------------------------------------|-------------|---------------------------|-----------------------|------------------------|-----------------|
| 1225AS-H-R47N□ | 0.47μH ±30% | 0.1MHz | 2500mA | 3100mA | 0.026Ω+20%/-30% |
| 1225AS-H-R68N□ | 0.68μH ±30% | 0.1MHz | 2000mA | 2900mA | 0.031Ω+20%/-30% |
| 1225AS-H-1R0N□ | 1.0μH ±30% | 0.1MHz | 1800mA | 2700mA | 0.036Ω+20%/-30% |
| 1225AS-H-1R5N□ | 1.5μH ±30% | 0.1MHz | 1500mA | 2400mA | 0.043Ω+20%/-30% |
| 1225AS-H-2R2M□ | 2.2μH ±20% | 0.1MHz | 1200mA | 2000mA | 0.058Ω+20%/-30% |
| 1225AS-H-3R3M□ | 3.3μH ±20% | 0.1MHz | 1000mA | 1500mA | 0.080Ω+20%/-30% |
| 1225AS-H-4R7M□ | 4.7μH ±20% | 0.1MHz | 880mA | 1400mA | 0.105Ω+20%/-30% |
| 1225AS-H-6R8M□ | 6.8μH ±20% | 0.1MHz | 720mA | 1100mA | 0.170Ω+20%/-30% |
| 1225AS-H-100M□ | 10μH ±20% | 0.1MHz | 580mA | 850mA | 0.250Ω+20%/-30% |
| 1225AS-H-120M□ | 12μH ±20% | 0.1MHz | 550mA | 760mA | 0.290Ω+20%/-30% |

Operating temp. range (Self-temp. rise included): -40 to 85°C

Class of Magnetic Shield: Ferrite Core

Only for reflow soldering

*Isat: Rated Current based on Inductance change

*Itemp: Rated Current based on Temperature rise

Rated current (Isat) is specified when the decrease of the initial inductance value at 30%. Rated current (Itemp) is specified when temperature of the inductor is raised 40°C by DC current.

Inductance-Current Characteristics (Typ.)



Temperature Rise Characteristics (Typ.)



DEM2815C Series 1211 (3028) inch (mm)



| Packaging Code | Packaging | Minimum Quantity |
|----------------|------------------------|------------------|
| =P2 | ø180mm Embossed Taping | 2000 |

Continued on the following page. ↗

Continued from the preceding page. ↘

| Part Number (□: packaging code) | Inductance | Inductance Test Frequency | Rated Current (Isat)* | Rated Current (Itemp)* | DC Resistance |
|------------------------------------|-------------|------------------------------|-----------------------|------------------------|-----------------|
| 1226AS-H-R47N□ | 0.47μH ±30% | 0.1MHz | 2900mA | 3900mA | 0.020Ω+20%/-30% |
| 1226AS-H-1R0N□ | 1.0μH ±30% | 0.1MHz | 2100mA | 3300mA | 0.027Ω+20%/-30% |
| 1226AS-H-1R5N□ | 1.5μH ±30% | 0.1MHz | 1700mA | 2900mA | 0.031Ω+20%/-30% |
| 1226AS-H-2R2M□ | 2.2μH ±20% | 0.1MHz | 1400mA | 2200mA | 0.043Ω+20%/-30% |
| 1226AS-H-2R7M□ | 2.7μH ±20% | 0.1MHz | 1300mA | 2000mA | 0.053Ω+20%/-30% |
| 1226AS-H-3R3M□ | 3.3μH ±20% | 0.1MHz | 1100mA | 1900mA | 0.057Ω+20%/-30% |
| 1226AS-H-4R7M□ | 4.7μH ±20% | 0.1MHz | 950mA | 1600mA | 0.080Ω+20%/-30% |
| 1226AS-H-6R8M□ | 6.8μH ±20% | 0.1MHz | 800mA | 1200mA | 0.130Ω+20%/-30% |
| 1226AS-H-100M□ | 10μH ±20% | 0.1MHz | 650mA | 1000mA | 0.180Ω+20%/-30% |
| 1226AS-H-120M□ | 12μH ±20% | 0.1MHz | 600mA | 850mA | 0.228Ω+20%/-30% |
| 1226AS-H-150M□ | 15μH ±20% | 0.1MHz | 500mA | 800mA | 0.270Ω+20%/-30% |

Operating temp. range (Self-temp. rise included): -40 to 85°C

Class of Magnetic Shield: Ferrite Core

Only for reflow soldering

*Isat: Rated Current based on Inductance change

*Itemp: Rated Current based on Temperature rise

Rated current (Isat) is specified when the decrease of the initial inductance value at 30%. Rated current (Itemp) is specified when temperature of the inductor is raised 40°C by DC current.

Inductance-Current Characteristics (Typ.)

Temperature Rise Characteristics (Typ.)



DEM2818C Series 1211 (3028) inch (mm)



| Packaging Code | Packaging | Minimum Quantity |
|----------------|------------------------|------------------|
| -P2 | ø180mm Embossed Taping | 2000 |

| Part Number (□: packaging code) | Inductance | Inductance Test Frequency | Rated Current (Isat)* | Rated Current (Itemp)* | DC Resistance |
|------------------------------------|-------------|------------------------------|-----------------------|------------------------|-----------------|
| 1227AS-H-R47N□ | 0.47μH ±30% | 0.1MHz | 3300mA | 4700mA | 0.017Ω+20%/-30% |
| 1227AS-H-1R0N□ | 1.0μH ±30% | 0.1MHz | 2300mA | 3700mA | 0.024Ω+20%/-30% |
| 1227AS-H-1R5N□ | 1.5μH ±30% | 0.1MHz | 2000mA | 3400mA | 0.027Ω+20%/-30% |
| 1227AS-H-2R2M□ | 2.2μH ±20% | 0.1MHz | 1700mA | 2600mA | 0.039Ω+20%/-30% |
| 1227AS-H-3R3M□ | 3.3μH ±20% | 0.1MHz | 1300mA | 2000mA | 0.056Ω+20%/-30% |
| 1227AS-H-4R7M□ | 4.7μH ±20% | 0.1MHz | 1100mA | 1800mA | 0.077Ω+20%/-30% |
| 1227AS-H-6R8M□ | 6.8μH ±20% | 0.1MHz | 900mA | 1300mA | 0.122Ω+20%/-30% |

Operating temp. range (Self-temp. rise included): -40 to 85°C

Class of Magnetic Shield: Ferrite Core

Only for reflow soldering

*Isat: Rated Current based on Inductance change

*Itemp: Rated Current based on Temperature rise

Rated current (Isat) is specified when the decrease of the initial inductance value at 30%. Rated current (Itemp) is specified when temperature of the inductor is raised 40°C by DC current.

Inductors for Power Lines DEM2818C
 Inductors for General Circuits
 RF Inductors

Continued from the preceding page. ↘

| Part Number (□: packaging code) | Inductance | Inductance Test Frequency | Rated Current (Isat)* | Rated Current (Itemp)* | DC Resistance |
|------------------------------------|------------|---------------------------|-----------------------|------------------------|-----------------|
| 1227AS-H-100M□ | 10μH ±20% | 0.1MHz | 750mA | 1200mA | 0.170Ω+20%/-30% |
| 1227AS-H-120M□ | 12μH ±20% | 0.1MHz | 650mA | 1000mA | 0.215Ω+20%/-30% |

Operating temp. range (Self-temp. rise included): -40 to 85°C

Class of Magnetic Shield: Ferrite Core

Only for reflow soldering

*Isat: Rated Current based on Inductance change

*Itemp: Rated Current based on Temperature rise

Rated current (Isat) is specified when the decrease of the initial inductance value at 30%. Rated current (Itemp) is specified when temperature of the inductor is raised 40°C by DC current.

Inductance-Current Characteristics (Typ.)



Temperature Rise Characteristics (Typ.)



LQH3NPN_GR Series 1212 (3030) inch (mm)



| Packaging Code | Packaging | Minimum Quantity |
|----------------|------------------------|------------------|
| K | ø330mm Embossed Taping | 11000 |
| L | ø180mm Embossed Taping | 3000 |

| Part Number (□: packaging code) | Inductance | Inductance Test Frequency | Rated Current (Isat)* | Rated Current (Itemp)* | DC Resistance | S.R.F.* (min.) | Operating temp. range (Self-temp. rise included) | Operating temp. range (Self-temp. rise not included) | Remark |
|------------------------------------|-------------|---------------------------|-----------------------|---|---------------|----------------|---|---|--------|
| LQH3NPNR47NGR□ | 0.47μH ±30% | 1MHz | 2820mA | 2540mA(Ambient temp.85°C) 1520mA(Ambient temp.105°C) | 0.047Ω±20% | 180MHz | -40 to 125°C | -40 to 105°C | *1 |
| LQH3NPN1R0MGR□ | 1.0μH ±20% | 1MHz | 1700mA | 2080mA(Ambient temp.85°C) 1240mA(Ambient temp.105°C) | 0.062Ω±20% | 100MHz | -40 to 125°C | -40 to 105°C | *1 |
| LQH3NPN1R5MGR□ | 1.5μH ±20% | 1MHz | 1400mA | 2040mA(Ambient temp.85°C) 1220mA(Ambient temp.105°C) | 0.074Ω±20% | 80MHz | -40 to 125°C | -40 to 105°C | *1 |
| LQH3NPN2R2MGR□ | 2.2μH ±20% | 1MHz | 1180mA | 1730mA(Ambient temp.85°C) 1030mA(Ambient temp.105°C) | 0.087Ω±20% | 50MHz | -40 to 125°C | -40 to 105°C | *1 |
| LQH3NPN3R3MGR□ | 3.3μH ±20% | 1MHz | 1050mA | 1580mA(Ambient temp.85°C) 940mA(Ambient temp.105°C) | 0.12Ω±20% | 30MHz | -40 to 125°C | -40 to 105°C | *1 |
| LQH3NPN4R7MGR□ | 4.7μH ±20% | 1MHz | 850mA | 1520mA(Ambient temp.85°C) 910mA(Ambient temp.105°C) | 0.14Ω±20% | 27MHz | -40 to 125°C | -40 to 105°C | *1 |

Class of Magnetic Shield: Magnetic Resin

Only for reflow soldering

*Isat: Rated Current based on Inductance change

*Itemp: Rated Current based on Temperature rise

*S.R.F.: Self Resonant Frequency

*1: When rated current is applied to the products, inductance will be within ±30% of initial inductance value range. Keep the temperature (ambient temperature plus self-generation of heat) under 125°C. When rated current is applied to the products, the temperature rise caused by self-generated heat shall be limited to 40°C (at the rated current under 85°C) or 20°C (at the rated current under 105°C).

*2: When rated current is applied to the products, inductance will be within ±30% of initial inductance value range. Keep the temperature (ambient temperature plus self-generation of heat) under 105°C. When rated current is applied to the products, the temperature rise caused by self-generated heat shall be limited to 20°C.

Continued on the following page. ↗

Continued from the preceding page. ↘

| Part Number (□: packaging code) | Inductance | Inductance Test Frequency | Rated Current (Isat)* | Rated Current (Itemp)* | DC Resistance | S.R.F.* (min.) | Operating temp. range (Self-temp. rise included) | Operating temp. range (Self-temp. rise not included) | Remark |
|------------------------------------|------------|------------------------------|-----------------------|--|---------------|----------------|---|---|--------|
| LQH3NPN6R8MGR□ | 6.8μH ±20% | 1MHz | 720mA | 1140mA(Ambient temp.85°C) 680mA(Ambient temp.105°C) | 0.23Ω±20% | 25MHz | -40 to 125°C | -40 to 105°C | *1 |
| LQH3NPN100MGR□ | 10μH ±20% | 1MHz | 570mA | 1120mA(Ambient temp.85°C) 670mA(Ambient temp.105°C) | 0.28Ω±20% | 20MHz | -40 to 125°C | -40 to 105°C | *1 |
| LQH3NPN150MGR□ | 15μH ±20% | 1MHz | 480mA | 900mA(Ambient temp.85°C) 540mA(Ambient temp.105°C) | 0.39Ω±20% | 15MHz | -40 to 125°C | -40 to 105°C | *1 |
| LQH3NPN220MGR□ | 22μH ±20% | 1MHz | 390mA | 750mA(Ambient temp.85°C) 450mA(Ambient temp.105°C) | 0.53Ω±20% | 10MHz | -40 to 125°C | -40 to 105°C | *1 |
| LQH3NPN330MGR□ | 33μH ±20% | 1MHz | 320mA | 600mA(Ambient temp.85°C) 360mA(Ambient temp.105°C) | 0.86Ω±20% | 8MHz | -40 to 125°C | -40 to 105°C | *1 |
| LQH3NPN470MGR□ | 47μH ±20% | 1MHz | 260mA | 460mA(Ambient temp.85°C) 270mA(Ambient temp.105°C) | 1.4Ω±20% | 5MHz | -40 to 125°C | -40 to 105°C | *1 |
| LQH3NPN680MGR□ | 68μH ±20% | 1MHz | 220mA | 280mA(Ambient temp.85°C) | 2.1Ω±20% | 6MHz | -40 to 105°C | -40 to 85°C | *2 |
| LQH3NPN101MGR□ | 100μH ±20% | 1MHz | 190mA | 220mA(Ambient temp.85°C) | 3.2Ω±20% | 5MHz | -40 to 105°C | -40 to 85°C | *2 |
| LQH3NPN151MGR□ | 150μH ±20% | 1MHz | 160mA | 180mA(Ambient temp.85°C) | 4.9Ω±20% | 3MHz | -40 to 105°C | -40 to 85°C | *2 |
| LQH3NPN181MGR□ | 180μH ±20% | 1MHz | 130mA | 160mA(Ambient temp.85°C) | 6.4Ω±20% | 2MHz | -40 to 105°C | -40 to 85°C | *2 |
| LQH3NPN221MGR□ | 220μH ±20% | 1MHz | 120mA | 150mA(Ambient temp.85°C) | 7.5Ω±20% | 2MHz | -40 to 105°C | -40 to 85°C | *2 |
| LQH3NPN251MGR□ | 250μH ±20% | 1MHz | 110mA | 140mA(Ambient temp.85°C) | 8Ω±20% | 2MHz | -40 to 105°C | -40 to 85°C | *2 |

Class of Magnetic Shield: Magnetic Resin

Only for reflow soldering

*Isat: Rated Current based on Inductance change

*Itemp: Rated Current based on Temperature rise

*S.R.F.: Self Resonant Frequency

*1: When rated current is applied to the products, inductance will be within ±30% of initial inductance value range. Keep the temperature (ambient temperature plus self-generation of heat) under 125°C. When rated current is applied to the products, the temperature rise caused by self-generated heat shall be limited to 40°C (at the rated current under 85°C) or 20°C (at the rated current under 105°C).

*2: When rated current is applied to the products, inductance will be within ±30% of initial inductance value range. Keep the temperature (ambient temperature plus self-generation of heat) under 105°C. When rated current is applied to the products, the temperature rise caused by self-generated heat shall be limited to 20°C.

Inductance-Frequency Characteristics (Typ.)



Inductance-Current Characteristics (Typ.)



Temperature Rise Characteristics (Typ.)



LQH3NPN_JR Series 1212 (3030) inch (mm)



| Packaging Code | Packaging | Minimum Quantity |
|----------------|------------------------|------------------|
| K | ø330mm Embossed Taping | 8000 |
| L | ø180mm Embossed Taping | 2000 |

Continued on the following page. ↗

Continued from the preceding page. ↘

| Part Number (□: packaging code) | Inductance | Inductance Test Frequency | Rated Current (Isat)* | Rated Current (Itemp)* | DC Resistance | S.R.F.* (min.) |
|------------------------------------|-------------|------------------------------|-----------------------|---|---------------|----------------|
| LQH3NPNR68NJR□ | 0.68μH ±30% | 1MHz | 2700mA | 2860mA(Ambient temp.85°C) 1280mA(Ambient temp.105°C) | 0.032Ω±20% | 130MHz |
| LQH3NPN1R0MJR□ | 1.0μH ±20% | 1MHz | 2250mA | 2780mA(Ambient temp.85°C) 1230mA(Ambient temp.105°C) | 0.040Ω±20% | 100MHz |
| LQH3NPN1R5MJR□ | 1.5μH ±20% | 1MHz | 1950mA | 2510mA(Ambient temp.85°C) 1100mA(Ambient temp.105°C) | 0.049Ω±20% | 60MHz |
| LQH3NPN2R2MJR□ | 2.2μH ±20% | 1MHz | 1800mA | 2200mA(Ambient temp.85°C) 980mA(Ambient temp.105°C) | 0.068Ω±20% | 45MHz |
| LQH3NPN3R3MJR□ | 3.3μH ±20% | 1MHz | 1350mA | 1700mA(Ambient temp.85°C) 750mA(Ambient temp.105°C) | 0.095Ω±20% | 45MHz |
| LQH3NPN4R7MJR□ | 4.7μH ±20% | 1MHz | 1180mA | 1580mA(Ambient temp.85°C) 710mA(Ambient temp.105°C) | 0.12Ω±20% | 40MHz |
| LQH3NPN6R8MJR□ | 6.8μH ±20% | 1MHz | 970mA | 1360mA(Ambient temp.85°C) 610mA(Ambient temp.105°C) | 0.18Ω±20% | 35MHz |
| LQH3NPN100MJR□ | 10μH ±20% | 1MHz | 810mA | 1200mA(Ambient temp.85°C) 530mA(Ambient temp.105°C) | 0.24Ω±20% | 30MHz |
| LQH3NPN150MJR□ | 15μH ±20% | 1MHz | 650mA | 870mA(Ambient temp.85°C) 370mA(Ambient temp.105°C) | 0.38Ω±20% | 25MHz |
| LQH3NPN220MJR□ | 22μH ±20% | 1MHz | 520mA | 800mA(Ambient temp.85°C) 350mA(Ambient temp.105°C) | 0.50Ω±20% | 20MHz |
| LQH3NPN330MJR□ | 33μH ±20% | 1MHz | 420mA | 630mA(Ambient temp.85°C) 280mA(Ambient temp.105°C) | 0.79Ω±20% | 15MHz |
| LQH3NPN470MJR□ | 47μH ±20% | 1MHz | 360mA | 570mA(Ambient temp.85°C) 240mA(Ambient temp.105°C) | 1.0Ω±20% | 10MHz |

Operating temp. range (Self-temp. rise included): -40 to 125°C

Operating temp. range (Self-temp. rise not included): -40 to 105°C

Class of Magnetic Shield: Magnetic Resin

Only for reflow soldering

*Isat: Rated Current based on Inductance change

*Itemp: Rated Current based on Temperature rise

*S.R.F.: Self Resonant Frequency

When rated current is applied to the products, inductance will be within ±30% of initial inductance value range. Keep the temperature (ambient temperature plus self-generation of heat) under 125°C. When rated current is applied to the products, the self-temperature rise shall be limited to 40°C max. (ambient temperature 85°C). When rated current is applied to the products, the self-temperature rise shall be limited to 20°C max. (ambient temperature 85°C to 105°C).

Inductance-Frequency Characteristics (Typ.)



Inductance-Current Characteristics (Typ.)



Temperature Rise Characteristics (Typ.)



LQH3NPN_JR
 Inductors for Power Lines

Inductors for General Circuits

RF Inductors

LQH3NPN_ME Series 1212 (3030) inch (mm)



| Packaging Code | Packaging | Minimum Quantity |
|----------------|------------------------|------------------|
| K | ø330mm Embossed Taping | 8000 |
| L | ø180mm Embossed Taping | 2000 |
| B | Packing in Bulk | 100 |

| Part Number (□: packaging code) | Inductance | Inductance Test Frequency | Rated Current (I _{sat})* | Rated Current (I _{temp})* | DC Resistance | S.R.F.* (min.) |
|------------------------------------|------------|------------------------------|------------------------------------|---|---------------|----------------|
| LQH3NPN1R0MME□ | 1.0μH ±20% | 1MHz | 2350mA | 3000mA(Ambient temp.85°C) 1600mA(Ambient temp.105°C) | 0.025Ω±20% | 100MHz |
| LQH3NPN2R2MME□ | 2.2μH ±20% | 1MHz | 1800mA | 2100mA(Ambient temp.85°C) 1220mA(Ambient temp.105°C) | 0.065Ω±20% | 60MHz |
| LQH3NPN3R3MME□ | 3.3μH ±20% | 1MHz | 1520mA | 1900mA(Ambient temp.85°C) 1150mA(Ambient temp.105°C) | 0.084Ω±20% | 55MHz |
| LQH3NPN4R7MME□ | 4.7μH ±20% | 1MHz | 1300mA | 1700mA(Ambient temp.85°C) 1000mA(Ambient temp.105°C) | 0.1Ω±20% | 40MHz |
| LQH3NPN6R8MME□ | 6.8μH ±20% | 1MHz | 1040mA | 1450mA(Ambient temp.85°C) 900mA(Ambient temp.105°C) | 0.14Ω±20% | 30MHz |
| LQH3NPN100MME□ | 10μH ±20% | 1MHz | 810mA | 1280mA(Ambient temp.85°C) 800mA(Ambient temp.105°C) | 0.19Ω±20% | 20MHz |
| LQH3NPN150MME□ | 15μH ±20% | 1MHz | 660mA | 1020mA(Ambient temp.85°C) 620mA(Ambient temp.105°C) | 0.29Ω±20% | 15MHz |
| LQH3NPN220MME□ | 22μH ±20% | 1MHz | 570mA | 860mA(Ambient temp.85°C) 540mA(Ambient temp.105°C) | 0.4Ω±20% | 10MHz |
| LQH3NPN330MME□ | 33μH ±20% | 1MHz | 440mA | 760mA(Ambient temp.85°C) 460mA(Ambient temp.105°C) | 0.55Ω±20% | 8MHz |
| LQH3NPN470MME□ | 47μH ±20% | 1MHz | 380mA | 610mA(Ambient temp.85°C) 380mA(Ambient temp.105°C) | 0.82Ω±20% | 5MHz |
| LQH3NPN560MME□ | 56μH ±20% | 1MHz | 350mA | 500mA(Ambient temp.85°C) 320mA(Ambient temp.105°C) | 1Ω±20% | 5MHz |
| LQH3NPN680MME□ | 68μH ±20% | 1MHz | 310mA | 470mA(Ambient temp.85°C) 300mA(Ambient temp.105°C) | 1.15Ω±20% | 5MHz |
| LQH3NPN101MME□ | 100μH ±20% | 1MHz | 260mA | 430mA(Ambient temp.85°C) 270mA(Ambient temp.105°C) | 1.59Ω±20% | 3MHz |

Operating temp. range (Self-temp. rise included): -40 to 125°C

Operating temp. range (Self-temp. rise not included): -40 to 105°C

Class of Magnetic Shield: Magnetic Resin

Only for reflow soldering

*I_{sat}: Rated Current based on Inductance change

*I_{temp}: Rated Current based on Temperature rise

*S.R.F.: Self Resonant Frequency

When rated current is applied to the products, inductance will be within ±30% of initial inductance value range. Keep the temperature (ambient temperature plus self-generation of heat) under 125°C. When rated current is applied to the products, the self-temperature rise shall be limited to 40°C max. (ambient temperature 85°C). When rated current is applied to the products, the self-temperature rise shall be limited to 20°C max. (ambient temperature 85°C to 105°C).

Continued on the following page. ↗

Continued from the preceding page. ↘

Inductance-Frequency Characteristics (Typ.)



Inductance-Current Characteristics (Typ.)



Temperature Rise Characteristics (Typ.)



DEM3512C Series 1514 (3735) inch (mm)



| Packaging Code | Packaging | Minimum Quantity |
|----------------|------------------------|------------------|
| =P3 | ø330mm Embossed Taping | 2000 |

| Part Number (□: packaging code) | Inductance | Inductance Test Frequency | Rated Current (Isat)* | Rated Current (Itemp)* | DC Resistance |
|------------------------------------|-------------|------------------------------|-----------------------|------------------------|-----------------|
| 1229AS-H-R68N□ | 0.68μH ±30% | 0.1MHz | 2500mA | 2250mA | 0.043Ω+20%/-30% |
| 1229AS-H-1R0N□ | 1.0μH ±30% | 0.1MHz | 2050mA | 1850mA | 0.054Ω+20%/-30% |
| 1229AS-H-1R5N□ | 1.5μH ±30% | 0.1MHz | 1650mA | 1800mA | 0.062Ω+20%/-30% |
| 1229AS-H-2R0M□ | 2.0μH ±20% | 0.1MHz | 1500mA | 1700mA | 0.073Ω+20%/-30% |
| 1229AS-H-3R3M□ | 3.3μH ±20% | 0.1MHz | 1300mA | 1650mA | 0.080Ω+20%/-30% |
| 1229AS-H-4R7M□ | 4.7μH ±20% | 0.1MHz | 1100mA | 1350mA | 0.105Ω+20%/-30% |
| 1229AS-H-6R8M□ | 6.8μH ±20% | 0.1MHz | 900mA | 1200mA | 0.160Ω+20%/-30% |
| 1229AS-H-100M□ | 10μH ±20% | 0.1MHz | 750mA | 850mA | 0.240Ω+20%/-30% |
| 1229AS-H-120M□ | 12μH ±20% | 0.1MHz | 650mA | 790mA | 0.280Ω+20%/-30% |
| 1229AS-H-150M□ | 15μH ±20% | 0.1MHz | 590mA | 720mA | 0.340Ω+20%/-30% |
| 1229AS-H-220M□ | 22μH ±20% | 0.1MHz | 500mA | 530mA | 0.560Ω+20%/-30% |

Operating temp. range (Self-temp. rise included): -40 to 85°C

Class of Magnetic Shield: Ferrite Core

Only for reflow soldering

*Isat: Rated Current based on Inductance change

*Itemp: Rated Current based on Temperature rise

Rated current (Isat) is specified when the decrease of the initial inductance value at 30%. Rated current (Itemp) is specified when temperature of the inductor is raised 40°C by DC current.

Inductance-Current Characteristics (Typ.)

Temperature Rise Characteristics (Typ.)

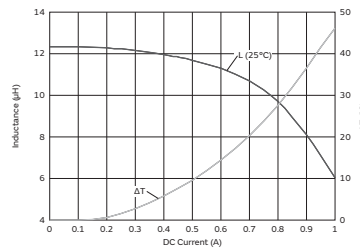
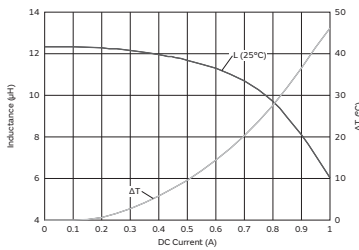

DEM3518C Series 1514 (3735) inch (mm)



| Packaging Code | Packaging | Minimum Quantity |
|----------------|------------------------|------------------|
| =P3 | ø330mm Embossed Taping | 2000 |

Continued on the following page. ↗

Continued from the preceding page. ↘

| Part Number (□: packaging code) | Inductance | Inductance Test Frequency | Rated Current (Isat)* | Rated Current (Itemp)* | DC Resistance |
|------------------------------------|-------------|------------------------------|-----------------------|------------------------|-----------------|
| 1231AS-H-R56N□ | 0.56μH ±30% | 0.1MHz | 3300mA | 3400mA | 0.024Ω+20%/-30% |
| 1231AS-H-1R2N□ | 1.2μH ±30% | 0.1MHz | 2400mA | 2900mA | 0.030Ω+20%/-30% |
| 1231AS-H-1R5N□ | 1.5μH ±30% | 0.1MHz | 2100mA | 2700mA | 0.035Ω+20%/-30% |
| 1231AS-H-2R2M□ | 2.2μH ±20% | 0.1MHz | 1900mA | 2550mA | 0.040Ω+20%/-30% |
| 1231AS-H-3R3M□ | 3.3μH ±20% | 0.1MHz | 1600mA | 2250mA | 0.050Ω+20%/-30% |
| 1231AS-H-4R7M□ | 4.7μH ±20% | 0.1MHz | 1350mA | 2000mA | 0.060Ω+20%/-30% |
| 1231AS-H-6R4M□ | 6.4μH ±20% | 0.1MHz | 1150mA | 1650mA | 0.085Ω+20%/-30% |
| 1231AS-H-100M□ | 10μH ±20% | 0.1MHz | 900mA | 1250mA | 0.145Ω+20%/-30% |
| 1231AS-H-120M□ | 12μH ±20% | 0.1MHz | 850mA | 1200mA | 0.155Ω+20%/-30% |
| 1231AS-H-150M□ | 15μH ±20% | 0.1MHz | 800mA | 1100mA | 0.185Ω+20%/-30% |
| 1231AS-H-220M□ | 22μH ±20% | 0.1MHz | 650mA | 880mA | 0.285Ω+20%/-30% |

Operating temp. range (Self-temp. rise included): -40 to 85°C

Class of Magnetic Shield: Ferrite Core

Only for reflow soldering

*Isat: Rated Current based on Inductance change

*Itemp: Rated Current based on Temperature rise

Rated current (Isat) is specified when the decrease of the initial inductance value at 30%. Rated current (Itemp) is specified when temperature of the inductor is raised 40°C by DC current.

Inductance-Current Characteristics (Typ.)



Temperature Rise Characteristics (Typ.)



LQH44PN_GR Series 1515 (4040) inch (mm)



(in mm)

| Packaging Code | Packaging | Minimum Quantity |
|----------------|------------------------|------------------|
| K | ø330mm Embossed Taping | 4500 |
| L | ø180mm Embossed Taping | 1000 |

| Part Number (□: packaging code) | Inductance | Inductance Test Frequency | Rated Current (Isat)* | Rated Current (Itemp)* | DC Resistance | S.R.F.* (min.) |
|------------------------------------|-------------|------------------------------|-----------------------|---|---------------|----------------|
| LQH44PNR68NGR□ | 0.68μH ±30% | 1MHz | 2400mA | 2500mA(Ambient temp.85°C) 1500mA(Ambient temp.105°C) | 0.043Ω±20% | 54MHz |
| LQH44PN2R2NGR□ | 2.2μH ±30% | 1MHz | 1600mA | 2000mA(Ambient temp.85°C) 1200mA(Ambient temp.105°C) | 0.074Ω±20% | 45MHz |

Operating temp. range (Self-temp. rise included): -40 to 125°C

Operating temp. range (Self-temp. rise not included): -40 to 105°C

Class of Magnetic Shield: Magnetic Resin

Only for reflow soldering

*Isat: Rated Current based on Inductance change

*Itemp: Rated Current based on Temperature rise

*S.R.F.: Self Resonant Frequency

When rated current is applied to the products, inductance will be within ±30% of initial inductance value range. Keep the temperature (ambient temperature plus self-generation of heat) under 125°C. When rated current is applied to the products, the self-temperature rise shall be limited to 40°C max (ambient temperature 85°C). When rated current is applied to the products, the self-temperature rise shall be limited to 20°C max (ambient temperature 85 °C to 105°C).

Continued on the following page. ↗

Continued from the preceding page. ↘

| Part Number (□: packaging code) | Inductance | Inductance Test Frequency | Rated Current (Isat)* | Rated Current (Itemp)* | DC Resistance | S.R.F.* (min.) |
|------------------------------------|------------|---------------------------|-----------------------|---|---------------|----------------|
| LQH44PN3R3NGR□ | 3.3μH ±30% | 1MHz | 1500mA | 1700mA(Ambient temp.85°C) 1000mA(Ambient temp.105°C) | 0.11Ω±20% | 25MHz |
| LQH44PN4R7MGR□ | 4.7μH ±20% | 1MHz | 1200mA | 1600mA(Ambient temp.85°C) 960mA(Ambient temp.105°C) | 0.13Ω±20% | 17MHz |
| LQH44PN6R8MGR□ | 6.8μH ±20% | 1MHz | 850mA | 1400mA(Ambient temp.85°C) 840mA(Ambient temp.105°C) | 0.17Ω±20% | 15MHz |
| LQH44PN100MGR□ | 10μH ±20% | 1MHz | 800mA | 1100mA(Ambient temp.85°C) 660mA(Ambient temp.105°C) | 0.27Ω±20% | 13MHz |
| LQH44PN150MGR□ | 15μH ±20% | 1MHz | 640mA | 900mA(Ambient temp.85°C) 540mA(Ambient temp.105°C) | 0.42Ω±20% | 10MHz |
| LQH44PN220MGR□ | 22μH ±20% | 1MHz | 500mA | 750mA(Ambient temp.85°C) 450mA(Ambient temp.105°C) | 0.57Ω±20% | 8MHz |
| LQH44PN330MGR□ | 33μH ±20% | 1MHz | 400mA | 480mA(Ambient temp.85°C) 280mA(Ambient temp.105°C) | 1.4Ω±20% | 6MHz |
| LQH44PN470MGR□ | 47μH ±20% | 1MHz | 360mA | 410mA(Ambient temp.85°C) 240mA(Ambient temp.105°C) | 1.7Ω±20% | 6MHz |

Operating temp. range (Self-temp. rise included): -40 to 125°C

Operating temp. range (Self-temp. rise not included): -40 to 105°C

Class of Magnetic Shield: Magnetic Resin

Only for reflow soldering

*Isat: Rated Current based on Inductance change

*Itemp: Rated Current based on Temperature rise

*S.R.F.: Self Resonant Frequency

When rated current is applied to the products, inductance will be within ±30% of initial inductance value range. Keep the temperature (ambient temperature plus self-generation of heat) under 125°C. When rated current is applied to the products, the self-temperature rise shall be limited to 40°C max (ambient temperature 85°C). When rated current is applied to the products, the self-temperature rise shall be limited to 20°C max (ambient temperature 85 °C to 105°C).

Inductance-Frequency Characteristics (Typ.)



Inductance-Current Characteristics (Typ.)



Temperature Rise Characteristics (Typ.)



LQH44PN_J0 Series 1515 (4040) inch (mm)



| Packaging Code | Packaging | Minimum Quantity |
|----------------|------------------------|------------------|
| K | ø330mm Embossed Taping | 4500 |
| L | ø180mm Embossed Taping | 1000 |

Continued on the following page. ↗

Continued from the preceding page. ↘

| Part Number (□: packaging code) | Inductance | Inductance Test Frequency | Rated Current (Isat)* | Rated Current (Itemp)* | DC Resistance | S.R.F.* (min.) |
|------------------------------------|------------|------------------------------|-----------------------|------------------------|---------------|----------------|
| LQH44PN1R0NJ0□ | 1.0μH ±30% | 100kHz | 2000mA | 1530mA | 0.048Ω±20% | 130MHz |
| LQH44PN1R5MJ0□ | 1.5μH ±20% | 100kHz | 1600mA | 1380mA | 0.061Ω±20% | 90MHz |
| LQH44PN2R2MJ0□ | 2.2μH ±20% | 100kHz | 1320mA | 1230mA | 0.074Ω±20% | 68MHz |
| LQH44PN3R3MJ0□ | 3.3μH ±20% | 100kHz | 900mA | 1000mA | 0.088Ω±20% | 55MHz |
| LQH44PN4R7MJ0□ | 4.7μH ±20% | 100kHz | 840mA | 980mA | 0.117Ω±20% | 50MHz |
| LQH44PN6R8MJ0□ | 6.8μH ±20% | 100kHz | 720mA | 860mA | 0.143Ω±20% | 38MHz |
| LQH44PN100MJ0□ | 10μH ±20% | 100kHz | 560mA | 790mA | 0.207Ω±20% | 30MHz |
| LQH44PN150MJ0□ | 15μH ±20% | 100kHz | 430mA | 610mA | 0.385Ω±20% | 25MHz |
| LQH44PN220MJ0□ | 22μH ±20% | 100kHz | 400mA | 550mA | 0.480Ω±20% | 18MHz |
| LQH44PN330MJ0□ | 33μH ±20% | 100kHz | 360mA | 430mA | 0.740Ω±20% | 15MHz |
| LQH44PN470MJ0□ | 47μH ±20% | 100kHz | 300mA | 380mA | 1.014Ω±20% | 13MHz |

Operating temp. range (Self-temp. rise included): -40 to 125°C
 Operating temp. range (Self-temp. rise not included): -40 to 85°C
 Class of Magnetic Shield: Magnetic Resin

Only for reflow soldering

*Isat: Rated Current based on Inductance change

*Itemp: Rated Current based on Temperature rise

*S.R.F.: Self Resonant Frequency

When rated current is applied to the products, inductance will be within ±30% of nominal inductance value. When rated current is applied to the products, the temperature rise caused by self-generated heat shall be limited to 40°C max. Keep the temperature (ambient temperature plus self-generation of heat) under 125°C.

Inductance-Frequency Characteristics (Typ.)



Inductance-Current Characteristics (Typ.)



Temperature Rise Characteristics (Typ.)



LQH44PN_P0 Series 1515 (4040) inch (mm)



(in mm)

| Packaging Code | Packaging | Minimum Quantity |
|----------------|------------------------|------------------|
| K | ø330mm Embossed Taping | 3500 |
| L | ø180mm Embossed Taping | 1000 |

Continued on the following page. ↗

LQH44PN_P0
 Inductors for Power Lines

Inductors for General Circuits

RF Inductors

Continued from the preceding page. ↘

| Part Number (□: packaging code) | Inductance | Inductance Test Frequency | Rated Current (Isat)* | Rated Current (Itemp)* | DC Resistance | S.R.F.* (min.) |
|------------------------------------|------------|---------------------------|-----------------------|------------------------|---------------|----------------|
| LQH44PN1R0NPO□ | 1.0μH ±30% | 1MHz | 2950mA | 2450mA | 0.030Ω±20% | 90MHz |
| LQH44PN2R2MPO□ | 2.2μH ±20% | 1MHz | 2500mA | 1800mA | 0.049Ω±20% | 70MHz |
| LQH44PN3R3MPO□ | 3.3μH ±20% | 1MHz | 2100mA | 1770mA | 0.065Ω±20% | 50MHz |
| LQH44PN4R7MPO□ | 4.7μH ±20% | 1MHz | 1700mA | 1700mA | 0.080Ω±20% | 40MHz |
| LQH44PN6R8MPO□ | 6.8μH ±20% | 1MHz | 1400mA | 1340mA | 0.12Ω±20% | 35MHz |
| LQH44PN100MPO□ | 10μH ±20% | 1MHz | 1150mA | 1170mA | 0.16Ω±20% | 25MHz |
| LQH44PN220MPO□ | 22μH ±20% | 1MHz | 800mA | 790mA | 0.37Ω±20% | 17MHz |

Operating temp. range (Self-temp. rise included): -40 to 125°C
 Operating temp. range (Self-temp. rise not included): -40 to 85°C
 Class of Magnetic Shield: Magnetic Resin
 Only for reflow soldering

*Isat: Rated Current based on Inductance change
 *Itemp: Rated Current based on Temperature rise
 *S.R.F.: Self Resonant Frequency

When rated current is applied to the products, inductance will be within ±30% of nominal inductance value. When rated current is applied to the products, the temperature rise caused by self-generated heat shall be limited to 40°C max. Keep the temperature (ambient temperature plus self-generation of heat) under 125°C.

Inductance-Frequency Characteristics (Typ.)



Inductance-Current Characteristics (Typ.)



Temperature Rise Characteristics (Typ.)



LQH43CN_03 Series 1812 (4532) inch (mm)



| Packaging Code | Packaging | Minimum Quantity |
|----------------|------------------------|------------------|
| L | ø180mm Embossed Taping | 500 |

| Part Number (□: packaging code) | Inductance | Inductance Test Frequency | Rated Current | Max. of DC Resistance | S.R.F.* (min.) |
|------------------------------------|------------|---------------------------|---------------|-----------------------|----------------|
| LQH43CN1R0M03□ | 1.0μH ±20% | 1MHz | 1080mA | 0.08Ω | 100MHz |
| LQH43CN1R5M03□ | 1.5μH ±20% | 1MHz | 1000mA | 0.09Ω | 85MHz |
| LQH43CN2R2M03□ | 2.2μH ±20% | 1MHz | 900mA | 0.11Ω | 60MHz |
| LQH43CN3R3M03□ | 3.3μH ±20% | 1MHz | 800mA | 0.13Ω | 47MHz |
| LQH43CN4R7M03□ | 4.7μH ±20% | 1MHz | 750mA | 0.15Ω | 35MHz |
| LQH43CN6R8M03□ | 6.8μH ±20% | 1MHz | 720mA | 0.20Ω | 30MHz |
| LQH43CN100K03□ | 10μH ±10% | 1MHz | 650mA | 0.24Ω | 23MHz |
| LQH43CN150K03□ | 15μH ±10% | 1MHz | 570mA | 0.32Ω | 20MHz |

Operating temp. range: -40 to 85°C
 Class of Magnetic Shield: No Shield
 *S.R.F.: Self Resonant Frequency

When rated current is applied to the products, self-temperature rise shall be limited to 20°C max and inductance will be within ±10% of initial inductance value.

Continued on the following page. ↗

Continued from the preceding page. ↘

| Part Number (□: packaging code) | Inductance | Inductance Test Frequency | Rated Current | Max. of DC Resistance | S.R.F.* (min.) |
|------------------------------------|------------|------------------------------|---------------|-----------------------|----------------|
| LQH43CN220K03□ | 22μH ±10% | 1MHz | 420mA | 0.6Ω | 15MHz |
| LQH43CN330K03□ | 33μH ±10% | 1MHz | 310mA | 1.0Ω | 12MHz |
| LQH43CN470K03□ | 47μH ±10% | 1MHz | 280mA | 1.1Ω | 10MHz |
| LQH43CN680K03□ | 68μH ±10% | 1MHz | 220mA | 1.7Ω | 8.4MHz |
| LQH43CN101K03□ | 100μH ±10% | 1MHz | 190mA | 2.2Ω | 6.8MHz |
| LQH43CN151K03□ | 150μH ±10% | 1MHz | 130mA | 3.5Ω | 5.5MHz |
| LQH43CN221K03□ | 220μH ±10% | 1MHz | 110mA | 4.0Ω | 4.5MHz |
| LQH43CN331K03□ | 330μH ±10% | 1MHz | 100mA | 6.8Ω | 3.6MHz |
| LQH43CN471K03□ | 470μH ±10% | 1kHz | 90mA | 8.5Ω | 3.0MHz |

Operating temp. range: -40 to 85°C

Class of Magnetic Shield: No Shield

*S.R.F.: Self Resonant Frequency

When rated current is applied to the products, self-temperature rise shall be limited to 20°C max and inductance will be within ±10% of initial inductance value.

Inductance-Frequency Characteristics (Typ.)

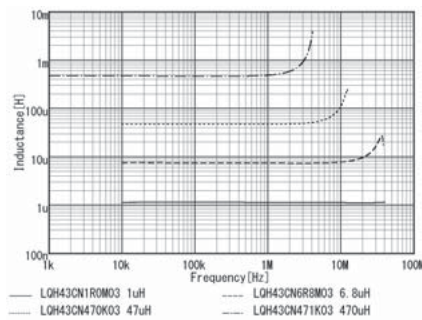

Inductance-Current Characteristics (Typ.)

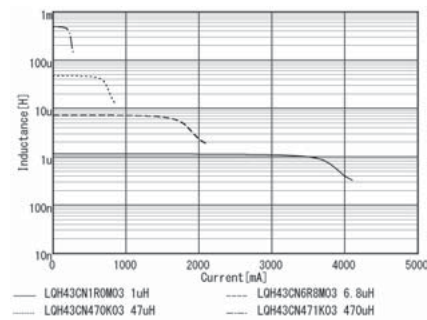

Impedance-Frequency Characteristics (Typ.)



LQH43CN_33 Series 1812 (4532) inch (mm)



| Packaging Code | Packaging | Minimum Quantity |
|----------------|------------------------|------------------|
| L | ø180mm Embossed Taping | 500 |

| Part Number (□: packaging code) | Inductance | Inductance Test Frequency | Rated Current | DC Resistance | S.R.F.* (min.) |
|------------------------------------|-------------|------------------------------|---------------|---------------|----------------|
| LQH43CNR56M33□ | 0.56μH ±20% | 1MHz | 2950mA | 0.023Ω±30% | 160MHz |
| LQH43CNR82M33□ | 0.82μH ±20% | 1MHz | 2800mA | 0.027Ω±30% | 130MHz |
| LQH43CN1R0M33□ | 1.0μH ±20% | 1MHz | 2600mA | 0.032Ω±30% | 110MHz |
| LQH43CN1R5M33□ | 1.5μH ±20% | 1MHz | 2450mA | 0.036Ω±30% | 80MHz |
| LQH43CN1R8M33□ | 1.8μH ±20% | 1MHz | 2300mA | 0.042Ω±30% | 70MHz |
| LQH43CN2R2M33□ | 2.2μH ±20% | 1MHz | 2100mA | 0.047Ω±30% | 60MHz |
| LQH43CN2R7M33□ | 2.7μH ±20% | 1MHz | 1800mA | 0.053Ω±30% | 50MHz |
| LQH43CN3R3M33□ | 3.3μH ±20% | 1MHz | 1650mA | 0.076Ω±30% | 47MHz |
| LQH43CN3R9M33□ | 3.9μH ±20% | 1MHz | 1600mA | 0.082Ω±30% | 40MHz |

Operating temp. range: -40 to 85°C

Class of Magnetic Shield: No Shield

*S.R.F.: Self Resonant Frequency

When rated current is applied to the products, inductance will be within ±20% of initial inductance value. When rated current is applied to the products, the temperature rise caused by self-generated heat shall be limited to 40°C max.

Continued on the following page. ↗

Continued from the preceding page. ↘

Inductance-Frequency Characteristics (Typ.)



Inductance-Current Characteristics (Typ.)



Impedance-Frequency Characteristics (Typ.)



LQH43PB_26 Series 1812 (4532) inch (mm)



| Packaging Code | Packaging | Minimum Quantity |
|----------------|------------------------|------------------|
| K | ø330mm Embossed Taping | 2500 |
| L | ø180mm Embossed Taping | 500 |

| Part Number (□: packaging code) | Inductance | Inductance Test Frequency | Rated Current (I _{sat})* | Rated Current (I _{temp})* | DC Resistance | S.R.F.* (min.) |
|------------------------------------|------------|---------------------------|------------------------------------|---|---------------|----------------|
| LQH43PB1R0N26□ | 1.0μH ±30% | 1MHz | 3400mA | 3300mA(Ambient temp.85°C) 1410mA(Ambient temp.105°C) | 0.026Ω±20% | 100MHz |
| LQH43PB2R2M26□ | 2.2μH ±20% | 1MHz | 2300mA | 2500mA(Ambient temp.85°C) 1120mA(Ambient temp.105°C) | 0.042Ω±20% | 45MHz |
| LQH43PB3R3M26□ | 3.3μH ±20% | 1MHz | 1800mA | 2100mA(Ambient temp.85°C) 1000mA(Ambient temp.105°C) | 0.052Ω±20% | 40MHz |
| LQH43PB4R7M26□ | 4.7μH ±20% | 1MHz | 1400mA | 1600mA(Ambient temp.85°C) 780mA(Ambient temp.105°C) | 0.075Ω±20% | 35MHz |
| LQH43PB6R8M26□ | 6.8μH ±20% | 1MHz | 1200mA | 1400mA(Ambient temp.85°C) 760mA(Ambient temp.105°C) | 0.098Ω±20% | 30MHz |
| LQH43PB8R2M26□ | 8.2μH ±20% | 1MHz | 1100mA | 1300mA(Ambient temp.85°C) 670mA(Ambient temp.105°C) | 0.128Ω±20% | 25MHz |
| LQH43PB100M26□ | 10μH ±20% | 1MHz | 1050mA | 1170mA(Ambient temp.85°C) 620mA(Ambient temp.105°C) | 0.147Ω±20% | 20MHz |
| LQH43PB220M26□ | 22μH ±20% | 1MHz | 700mA | 780mA(Ambient temp.85°C) 400mA(Ambient temp.105°C) | 0.327Ω±20% | 15MHz |
| LQH43PB470M26□ | 47μH ±20% | 1MHz | 470mA | 520mA(Ambient temp.85°C) 280mA(Ambient temp.105°C) | 0.718Ω±20% | 8MHz |
| LQH43PB101M26□ | 100μH ±20% | 1MHz | 320mA | 320mA(Ambient temp.85°C) 180mA(Ambient temp.105°C) | 1.538Ω±20% | 4MHz |

Operating temp. range (Self-temp. rise included): -40 to 125°C
 Operating temp. range (Self-temp. rise not included): -40 to 105°C
 Class of Magnetic Shield: Magnetic Resin

Only for reflow soldering

*I_{sat}: Rated Current based on Inductance change

*I_{temp}: Rated Current based on Temperature rise

*S.R.F.: Self Resonant Frequency

When rated current is applied to the products, inductance will be within ±30% of nominal inductance value. When rated current is applied to the products, the temperature rise caused by self-generated heat shall be limited to 40°C max. Keep the temperature (ambient temperature plus self-generation of heat) under 125°C.

Continued on the following page. ↗

Continued from the preceding page. ↘

| Part Number (□: packaging code) | Inductance | Inductance Test Frequency | Rated Current (I _{sat})* | Rated Current (I _{temp})* | DC Resistance | S.R.F.* (min.) |
|------------------------------------|------------|---------------------------|------------------------------------|---|---------------|----------------|
| LQH43PB151M26□ | 150μH ±20% | 1MHz | 280mA | 260mA(Ambient temp.85°C) 140mA(Ambient temp.105°C) | 2.362Ω±20% | 3MHz |
| LQH43PB221M26□ | 220μH ±20% | 1MHz | 220mA | 240mA(Ambient temp.85°C) 130mA(Ambient temp.105°C) | 2.900Ω±20% | 2MHz |

Operating temp. range (Self-temp. rise included): -40 to 125°C
 Operating temp. range (Self-temp. rise not included): -40 to 105°C
 Class of Magnetic Shield: Magnetic Resin

Only for reflow soldering

*I_{sat}: Rated Current based on Inductance change

*I_{temp}: Rated Current based on Temperature rise

*S.R.F.: Self Resonant Frequency

When rated current is applied to the products, inductance will be within ±30% of nominal inductance value. When rated current is applied to the products, the temperature rise caused by self-generated heat shall be limited to 40°C max. Keep the temperature (ambient temperature plus self-generation of heat) under 125°C.

Inductance-Frequency Characteristics (Typ.)



Inductance-Current Characteristics (Typ.)



Temperature Rise Characteristics (Typ.)



LQH43PN_26 Series 1812 (4532) inch (mm)



| Packaging Code | Packaging | Minimum Quantity |
|----------------|------------------------|------------------|
| K | ø330mm Embossed Taping | 2500 |
| L | ø180mm Embossed Taping | 500 |

| Part Number (□: packaging code) | Inductance | Inductance Test Frequency | Rated Current (I _{sat})* | Rated Current (I _{temp})* | DC Resistance | S.R.F.* (min.) |
|------------------------------------|------------|---------------------------|------------------------------------|-------------------------------------|---------------|----------------|
| LQH43PN1R0N26□ | 1.0μH ±30% | 1MHz | 3400mA | 3300mA | 0.026Ω±20% | 100MHz |
| LQH43PN2R2M26□ | 2.2μH ±20% | 1MHz | 2300mA | 2500mA | 0.042Ω±20% | 45MHz |
| LQH43PN3R3M26□ | 3.3μH ±20% | 1MHz | 1800mA | 2100mA | 0.052Ω±20% | 40MHz |
| LQH43PN4R7M26□ | 4.7μH ±20% | 1MHz | 1400mA | 1600mA | 0.075Ω±20% | 35MHz |
| LQH43PN6R8M26□ | 6.8μH ±20% | 1MHz | 1200mA | 1400mA | 0.098Ω±20% | 30MHz |
| LQH43PN8R2M26□ | 8.2μH ±20% | 1MHz | 1100mA | 1300mA | 0.128Ω±20% | 25MHz |
| LQH43PN100M26□ | 10μH ±20% | 1MHz | 1050mA | 1170mA | 0.147Ω±20% | 20MHz |
| LQH43PN220M26□ | 22μH ±20% | 1MHz | 700mA | 780mA | 0.327Ω±20% | 15MHz |
| LQH43PN470M26□ | 47μH ±20% | 1MHz | 470mA | 520mA | 0.718Ω±20% | 8MHz |

Operating temp. range: -40 to 85°C
 Class of Magnetic Shield: Magnetic Resin

*I_{sat}: Rated Current based on Inductance change

*I_{temp}: Rated Current based on Temperature rise

*S.R.F.: Self Resonant Frequency

When rated current is applied to the products, inductance will be within ±30% of nominal inductance value. When rated current is applied to the products, the temperature rise caused by self-generated heat shall be limited to 40°C max. Keep the temperature (ambient temperature plus self-generation of heat) under 125°C.

Continued on the following page. ↗

Continued from the preceding page. ↘

| Part Number (□: packaging code) | Inductance | Inductance Test Frequency | Rated Current (Isat)* | Rated Current (Itemp)* | DC Resistance | S.R.F.* (min.) |
|------------------------------------|------------|---------------------------|-----------------------|------------------------|---------------|----------------|
| LQH43PN101M26□ | 100μH ±20% | 1MHz | 320mA | 320mA | 1.538Ω±20% | 4MHz |
| LQH43PN151M26□ | 150μH ±20% | 1MHz | 280mA | 260mA | 2.362Ω±20% | 3MHz |
| LQH43PN221M26□ | 220μH ±20% | 1MHz | 220mA | 240mA | 2.900Ω±20% | 2MHz |

Operating temp. range: -40 to 85°C

Class of Magnetic Shield: Magnetic Resin

*Isat: Rated Current based on Inductance change

*Itemp: Rated Current based on Temperature rise

*S.R.F.: Self Resonant Frequency

When rated current is applied to the products, inductance will be within ±30% of nominal inductance value. When rated current is applied to the products, the temperature rise caused by self-generated heat shall be limited to 40°C max. Keep the temperature (ambient temperature plus self-generation of heat) under 125°C.

Inductance-Frequency Characteristics (Typ.)



Inductance-Current Characteristics (Typ.)



Temperature Rise Characteristics (Typ.)



DEM4518C Series 1818 (4745) inch (mm)



| Packaging Code | Packaging | Minimum Quantity |
|----------------|------------------------|------------------|
| =P3 | ø330mm Embossed Taping | 2000 |

| Part Number (□: packaging code) | Inductance | Inductance Test Frequency | Rated Current (Isat)* | Rated Current (Itemp)* | DC Resistance |
|------------------------------------|------------|---------------------------|-----------------------|------------------------|-----------------|
| 1235AS-H-1R2N□ | 1.2μH ±30% | 0.1MHz | 3500mA | 2900mA | 0.039Ω+20%/-30% |
| 1235AS-H-1R8N□ | 1.8μH ±30% | 0.1MHz | 3000mA | 2700mA | 0.047Ω+20%/-30% |
| 1235AS-H-2R4M□ | 2.4μH ±20% | 0.1MHz | 2600mA | 2300mA | 0.054Ω+20%/-30% |
| 1235AS-H-3R3M□ | 3.3μH ±20% | 0.1MHz | 2300mA | 2100mA | 0.062Ω+20%/-30% |
| 1235AS-H-4R3M□ | 4.3μH ±20% | 0.1MHz | 2000mA | 2000mA | 0.070Ω+20%/-30% |
| 1235AS-H-6R8M□ | 6.8μH ±20% | 0.1MHz | 1700mA | 1900mA | 0.088Ω+20%/-30% |
| 1235AS-H-100M□ | 10μH ±20% | 0.1MHz | 1300mA | 1700mA | 0.110Ω+20%/-30% |
| 1235AS-H-150M□ | 15μH ±20% | 0.1MHz | 980mA | 1100mA | 0.160Ω+20%/-30% |
| 1235AS-H-220M□ | 22μH ±20% | 0.1MHz | 910mA | 1000mA | 0.265Ω+20%/-30% |

Operating temp. range (Self-temp. rise included): -40 to 85°C

Class of Magnetic Shield: Ferrite Core

Only for reflow soldering

*Isat: Rated Current based on Inductance change

*Itemp: Rated Current based on Temperature rise

Rated current (Isat) is specified when the decrease of the initial inductance value at 30%. Rated current (Itemp) is specified when temperature of the inductor is raised 40°C by DC current.

Continued on the following page. ↗

Inductors for Power Lines DEM4518C
 Inductors for General Circuits
 RF Inductors

Continued from the preceding page. ↘

Inductance-Current Characteristics (Typ.)



Temperature Rise Characteristics (Typ.)



LQH5BPB_T0 Series 2020 (5050) inch (mm)



| Packaging Code | Packaging | Minimum Quantity |
|----------------|------------------------|------------------|
| K | ø330mm Embossed Taping | 3000 |
| L | ø180mm Embossed Taping | 500 |

| Part Number (□: packaging code) | Inductance | Inductance Test Frequency | Rated Current (Isat)* | Rated Current (Itemp)* | DC Resistance | S.R.F.* (min.) |
|------------------------------------|-------------|---------------------------|-----------------------|---|---------------|----------------|
| LQH5BPBR47NT0□ | 0.47µH ±30% | 100kHz | 7.7A | 4.0A(Ambient temp.85°C) 2.05A(Ambient temp.105°C) | 0.012Ω±20% | 220MHz |
| LQH5BPB1R0NT0□ | 1.0µH ±30% | 100kHz | 5.8A | 3.1A(Ambient temp.85°C) 1.68A(Ambient temp.105°C) | 0.019Ω±20% | 90MHz |
| LQH5BPB1R2NT0□ | 1.2µH ±30% | 100kHz | 5.4A | 3.1A(Ambient temp.85°C) 1.68A(Ambient temp.105°C) | 0.019Ω±20% | 90MHz |
| LQH5BPB1R5NT0□ | 1.5µH ±30% | 100kHz | 5.0A | 3.0A(Ambient temp.85°C) 1.63A(Ambient temp.105°C) | 0.024Ω±20% | 70MHz |
| LQH5BPB2R2NT0□ | 2.2µH ±30% | 100kHz | 4.0A | 2.6A(Ambient temp.85°C) 1.37A(Ambient temp.105°C) | 0.030Ω±20% | 55MHz |
| LQH5BPB2R7NT0□ | 2.7µH ±30% | 100kHz | 3.8A | 2.5A(Ambient temp.85°C) 1.23A(Ambient temp.105°C) | 0.035Ω±20% | 50MHz |
| LQH5BPB3R3NT0□ | 3.3µH ±30% | 100kHz | 3.5A | 2.3A(Ambient temp.85°C) 1.21A(Ambient temp.105°C) | 0.044Ω±20% | 40MHz |
| LQH5BPB4R7NT0□ | 4.7µH ±30% | 100kHz | 3.0A | 2.0A(Ambient temp.85°C) 1.09A(Ambient temp.105°C) | 0.058Ω±20% | 40MHz |
| LQH5BPB6R8NT0□ | 6.8µH ±30% | 100kHz | 2.5A | 1.65A(Ambient temp.85°C) 0.96A(Ambient temp.105°C) | 0.083Ω±20% | 30MHz |
| LQH5BPB100MT0□ | 10µH ±20% | 100kHz | 2.0A | 1.60A(Ambient temp.85°C) 0.87A(Ambient temp.105°C) | 0.106Ω±20% | 25MHz |
| LQH5BPB150MT0□ | 15µH ±20% | 100kHz | 1.6A | 1.20A(Ambient temp.85°C) 0.62A(Ambient temp.105°C) | 0.187Ω±20% | 18MHz |

Operating temp. range (Self-temp. rise included): -40 to 125°C
 Operating temp. range (Self-temp. rise not included): -40 to 105°C
 Class of Magnetic Shield: Magnetic Resin
 Only for reflow soldering

*Isat: Rated Current based on Inductance change
 *Itemp: Rated Current based on Temperature rise
 *S.R.F.: Self Resonant Frequency

When rated current is applied to the products, inductance will be within ±30% of nominal inductance value. When rated current is applied to the products, the temperature rise caused by self-generated heat shall be limited to 40°C max. Keep the temperature (ambient temperature plus self-generation of heat) under 125°C.

Continued on the following page. ↗

Continued from the preceding page. ↘

| Part Number (□: packaging code) | Inductance | Inductance Test Frequency | Rated Current (Isat)* | Rated Current (Itemp)* | DC Resistance | S.R.F.* (min.) |
|------------------------------------|------------|---------------------------|-----------------------|---|---------------|----------------|
| LQH5BPB220MT0□ | 22μH ±20% | 100kHz | 1.4A | 1.05A(Ambient temp.85°C) 0.55A(Ambient temp.105°C) | 0.259Ω±20% | 15MHz |

Operating temp. range (Self-temp. rise included): -40 to 125°C
 Operating temp. range (Self-temp. rise not included): -40 to 105°C
 Class of Magnetic Shield: Magnetic Resin

Only for reflow soldering

*Isat: Rated Current based on Inductance change

*Itemp: Rated Current based on Temperature rise

*S.R.F.: Self Resonant Frequency

When rated current is applied to the products, inductance will be within ±30% of nominal inductance value. When rated current is applied to the products, the temperature rise caused by self-generated heat shall be limited to 40°C max. Keep the temperature (ambient temperature plus self-generation of heat) under 125°C.

Inductance-Frequency Characteristics (Typ.)



Inductance-Current Characteristics (Typ.)



Temperature Rise Characteristics (Typ.)



LQH5BPN_38 Series 2020 (5050) inch (mm)



(in mm)

| Packaging Code | Packaging | Minimum Quantity |
|----------------|------------------------|------------------|
| K | ø330mm Embossed Taping | 1500 |
| L | ø180mm Embossed Taping | 400 |

| Part Number (□: packaging code) | Inductance | Inductance Test Frequency | Rated Current (Isat)* | Rated Current (Itemp)* | DC Resistance | S.R.F.* (min.) |
|------------------------------------|------------|---------------------------|-----------------------|------------------------|---------------|----------------|
| LQH5BPN1R0N38□ | 1.0μH ±30% | 100kHz | 7000mA | 4600mA | 0.012Ω±20% | 54MHz |
| LQH5BPN1R5N38□ | 1.5μH ±30% | 100kHz | 6500mA | 4500mA | 0.014Ω±20% | 50MHz |
| LQH5BPN2R2N38□ | 2.2μH ±30% | 100kHz | 5000mA | 4300mA | 0.016Ω±20% | 45MHz |
| LQH5BPN3R3N38□ | 3.3μH ±30% | 100kHz | 4000mA | 4000mA | 0.021Ω±20% | 25MHz |
| LQH5BPN4R7N38□ | 4.7μH ±30% | 100kHz | 3500mA | 3800mA | 0.026Ω±20% | 17MHz |
| LQH5BPN6R8M38□ | 6.8μH ±20% | 100kHz | 3000mA | 3000mA | 0.039Ω±20% | 15MHz |
| LQH5BPN100M38□ | 10μH ±20% | 100kHz | 2600mA | 2200mA | 0.056Ω±20% | 13MHz |
| LQH5BPN150M38□ | 15μH ±20% | 100kHz | 1800mA | 1900mA | 0.08Ω±20% | 10MHz |
| LQH5BPN220M38□ | 22μH ±20% | 100kHz | 1600mA | 1500mA | 0.11Ω±20% | 8.0MHz |

Operating temp. range (Self-temp. rise included): -40 to 125°C
 Operating temp. range (Self-temp. rise not included): -40 to 85°C
 Class of Magnetic Shield: Magnetic Resin

Only for reflow soldering

*Isat: Rated Current based on Inductance change

*Itemp: Rated Current based on Temperature rise

*S.R.F.: Self Resonant Frequency

When rated current is applied to the products, inductance will be within ±30% of initial inductance value range. When rated current is applied to the products, the temperature rise caused by self-generated heat shall be limited to 40°C max. (ambient temperature 85°C). Keep the temperature (ambient temperature plus self-generation of heat) under 125°C.

Continued on the following page. ↗

Continued from the preceding page. ↘

| Part Number (□: packaging code) | Inductance | Inductance Test Frequency | Rated Current (Isat)* | Rated Current (Itemp)* | DC Resistance | S.R.F.* (min.) |
|------------------------------------|------------|---------------------------|-----------------------|------------------------|---------------|----------------|
| LQH5BPN330M38□ | 33μH ±20% | 100kHz | 1300mA | 1300mA | 0.15Ω±20% | 6.5MHz |
| LQH5BPN470M38□ | 47μH ±20% | 100kHz | 1100mA | 1100mA | 0.22Ω±20% | 6.0MHz |
| LQH5BPN680M38□ | 68μH ±20% | 100kHz | 900mA | 930mA | 0.33Ω±20% | 5.0MHz |
| LQH5BPN101M38□ | 100μH ±20% | 100kHz | 750mA | 740mA | 0.48Ω±20% | 4.0MHz |
| LQH5BPN151M38□ | 150μH ±20% | 100kHz | 650mA | 630mA | 0.68Ω±20% | 3.5MHz |

Operating temp. range (Self-temp. rise included): -40 to 125°C
 Operating temp. range (Self-temp. rise not included): -40 to 85°C
 Class of Magnetic Shield: Magnetic Resin
 Only for reflow soldering

*Isat: Rated Current based on Inductance change
 *Itemp: Rated Current based on Temperature rise
 *S.R.F.: Self Resonant Frequency

When rated current is applied to the products, inductance will be within ±30% of initial inductance value range. When rated current is applied to the products, the temperature rise caused by self-generated heat shall be limited to 40°C max. (ambient temperature 85°C). Keep the temperature (ambient temperature plus self-generation of heat) under 125°C.

Inductance-Frequency Characteristics (Typ.)



Inductance-Current Characteristics (Typ.)



Temperature Rise Characteristics (Typ.)



LQH5BPN_T0 Series 2020 (5050) inch (mm)



| Packaging Code | Packaging | Minimum Quantity |
|----------------|------------------------|------------------|
| K | ø330mm Embossed Taping | 3000 |
| L | ø180mm Embossed Taping | 500 |

| Part Number (□: packaging code) | Inductance | Inductance Test Frequency | Rated Current (Isat)* | Rated Current (Itemp)* | DC Resistance | S.R.F.* (min.) |
|------------------------------------|-------------|---------------------------|-----------------------|------------------------|---------------|----------------|
| LQH5BPNR47NT0□ | 0.47μH ±30% | 100kHz | 7.7A | 4.0A | 0.012Ω±20% | 220MHz |
| LQH5BPN1R0NT0□ | 1.0μH ±30% | 100kHz | 5.8A | 3.1A | 0.019Ω±20% | 90MHz |
| LQH5BPN1R2NT0□ | 1.2μH ±30% | 100kHz | 5.4A | 3.1A | 0.019Ω±20% | 90MHz |
| LQH5BPN1R5NT0□ | 1.5μH ±30% | 100kHz | 5.0A | 3.0A | 0.024Ω±20% | 70MHz |
| LQH5BPN2R2NT0□ | 2.2μH ±30% | 100kHz | 4.0A | 2.6A | 0.030Ω±20% | 55MHz |
| LQH5BPN2R7NT0□ | 2.7μH ±30% | 100kHz | 3.8A | 2.5A | 0.035Ω±20% | 50MHz |

Operating temp. range (Self-temp. rise included): -40 to 125°C
 Operating temp. range (Self-temp. rise not included): -40 to 85°C
 Class of Magnetic Shield: Magnetic Resin
 Only for reflow soldering

*Isat: Rated Current based on Inductance change
 *Itemp: Rated Current based on Temperature rise
 *S.R.F.: Self Resonant Frequency

When rated current is applied to the products, inductance will be within ±30% of nominal inductance value. When rated current is applied to the products, the temperature rise caused by self-generated heat shall be limited to 40°C max. Keep the temperature (ambient temperature plus self-generation of heat) under 125°C.

Continued on the following page. ↗

Continued from the preceding page. ↘

| Part Number (□: packaging code) | Inductance | Inductance Test Frequency | Rated Current (Isat)* | Rated Current (Itemp)* | DC Resistance | S.R.F.* (min.) |
|------------------------------------|------------|---------------------------|-----------------------|------------------------|---------------|----------------|
| LQH5BPN3R3NTO□ | 3.3μH ±30% | 100kHz | 3.5A | 2.3A | 0.044Ω±20% | 40MHz |
| LQH5BPN4R7NTO□ | 4.7μH ±30% | 100kHz | 3.0A | 2.0A | 0.058Ω±20% | 40MHz |
| LQH5BPN6R8NTO□ | 6.8μH ±30% | 100kHz | 2.5A | 1.65A | 0.083Ω±20% | 30MHz |
| LQH5BPN100MTO□ | 10μH ±20% | 100kHz | 2.0A | 1.60A | 0.106Ω±20% | 25MHz |
| LQH5BPN150MTO□ | 15μH ±20% | 100kHz | 1.6A | 1.20A | 0.187Ω±20% | 18MHz |
| LQH5BPN220MTO□ | 22μH ±20% | 100kHz | 1.4A | 1.05A | 0.259Ω±20% | 15MHz |

Operating temp. range (Self-temp. rise included): -40 to 125°C
 Operating temp. range (Self-temp. rise not included): -40 to 85°C
 Class of Magnetic Shield: Magnetic Resin

Only for reflow soldering

*Isat: Rated Current based on Inductance change

*Itemp: Rated Current based on Temperature rise

*S.R.F.: Self Resonant Frequency

When rated current is applied to the products, inductance will be within ±30% of nominal inductance value. When rated current is applied to the products, the temperature rise caused by self-generated heat shall be limited to 40°C max. Keep the temperature (ambient temperature plus self-generation of heat) under 125°C.

Inductance-Frequency Characteristics (Typ.)



Inductance-Current Characteristics (Typ.)



Temperature Rise Characteristics (Typ.)

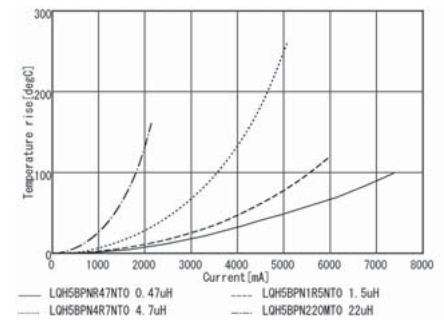

D52LC Series 2020 (5252) inch (mm)



| Packaging Code | Packaging | Minimum Quantity |
|----------------|------------------------|------------------|
| =P3 | ø330mm Embossed Taping | 2000 |

| Part Number (□: packaging code) | Inductance | Inductance Test Frequency | Rated Current (Isat)* | Rated Current (Itemp)* | Max. of DC Resistance |
|------------------------------------|------------|---------------------------|-----------------------|------------------------|-----------------------|
| #A914BYW-1R2M□ | 1.2μH ±20% | 0.1MHz | 2150mA | 2440mA | 0.044Ω |
| #A914BYW-2R2M□ | 2.2μH ±20% | 0.1MHz | 1630mA | 1740mA | 0.059Ω |
| #A914BYW-3R5M□ | 3.5μH ±20% | 0.1MHz | 1340mA | 1540mA | 0.073Ω |
| #A914BYW-4R7M□ | 4.7μH ±20% | 0.1MHz | 1140mA | 1300mA | 0.087Ω |
| #A914BYW-6R8M□ | 6.8μH ±20% | 0.1MHz | 950mA | 1170mA | 0.105Ω |
| #A914BYW-100M□ | 10μH ±20% | 0.1MHz | 760mA | 930mA | 0.150Ω |
| #A914BYW-150M□ | 15μH ±20% | 0.1MHz | 630mA | 770mA | 0.210Ω |
| #A914BYW-220M□ | 22μH ±20% | 0.1MHz | 560mA | 700mA | 0.275Ω |

Operating temp. range (Self-temp. rise included): -40 to 85°C
 Class of Magnetic Shield: Ferrite Core

Only for reflow soldering

*Isat: Rated Current based on Inductance change

*Itemp: Rated Current based on Temperature rise

Rated current (Isat) is specified when the decrease of the initial inductance value at 30%. Rated current (Itemp) is specified when temperature of the inductor is raised 40°C by DC current.

Continued on the following page. ↗

Continued from the preceding page. ↘

| Part Number (□: packaging code) | Inductance | Inductance Test Frequency | Rated Current (Isat)* | Rated Current (Itemp)* | Max. of DC Resistance |
|------------------------------------|------------|------------------------------|-----------------------|------------------------|-----------------------|
| #A914BYW-330M□ | 33μH ±20% | 0.1MHz | 440mA | 510mA | 0.455Ω |
| #A914BYW-470M□ | 47μH ±20% | 0.1MHz | 360mA | 380mA | 0.730Ω |
| #A914BYW-560M□ | 56μH ±20% | 0.1MHz | 330mA | 370mA | 0.828Ω |
| #A914BYW-680M□ | 68μH ±20% | 0.1MHz | 300mA | 350mA | 0.935Ω |
| #A914BY-101M□ | 100μH ±20% | 0.1MHz | 230mA | 260mA | 1.500Ω |

Operating temp. range (Self-temp. rise included): -40 to 85°C

Class of Magnetic Shield: Ferrite Core

Only for reflow soldering

*Isat: Rated Current based on Inductance change

*Itemp: Rated Current based on Temperature rise

Rated current (Isat) is specified when the decrease of the initial inductance value at 30%. Rated current (Itemp) is specified when temperature of the inductor is raised 40°C by DC current.

Inductance-Current Characteristics (Typ.)



Temperature Rise Characteristics (Typ.)



D53LC High Current Series 2020 (5252) inch (mm)

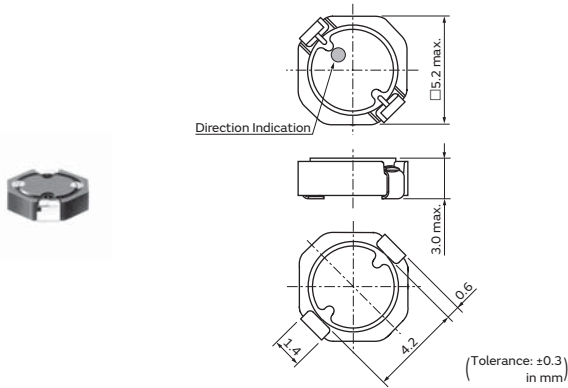

| Packaging Code | Packaging | Minimum Quantity |
|----------------|------------------------|------------------|
| =P3 | ø330mm Embossed Taping | 2000 |

| Part Number (□: packaging code) | Inductance | Inductance Test Frequency | Rated Current (Isat)* | Rated Current (Itemp)* | DC Resistance |
|------------------------------------|------------|------------------------------|-----------------------|------------------------|-----------------|
| #A915AY-1R1M□ | 1.1μH ±20% | 0.1MHz | 3870mA | 3250mA | 0.016Ω+20%/-30% |
| #A915AY-2R0M□ | 2.0μH ±20% | 0.1MHz | 2920mA | 2640mA | 0.022Ω+20%/-30% |
| #A915AY-3R3M□ | 3.3μH ±20% | 0.1MHz | 2360mA | 2260mA | 0.029Ω+20%/-30% |
| #A915AY-4R7M□ | 4.7μH ±20% | 0.1MHz | 1870mA | 2010mA | 0.038Ω+20%/-30% |
| #A915AY-6R8M□ | 6.8μH ±20% | 0.1MHz | 1510mA | 1650mA | 0.057Ω+20%/-30% |
| #A915AY-100M□ | 10μH ±20% | 0.1MHz | 1330mA | 1410mA | 0.075Ω+20%/-30% |
| #A915AY-150M□ | 15μH ±20% | 0.1MHz | 1050mA | 1100mA | 0.118Ω+20%/-30% |
| #A915AY-220M□ | 22μH ±20% | 0.1MHz | 860mA | 810mA | 0.173Ω+20%/-30% |
| #A915AY-330M□ | 33μH ±20% | 0.1MHz | 720mA | 750mA | 0.214Ω+20%/-30% |
| #A915AY-470M□ | 47μH ±20% | 0.1MHz | 620mA | 640mA | 0.293Ω+20%/-30% |
| #A915AY-680M□ | 68μH ±20% | 0.1MHz | 510mA | 520mA | 0.437Ω+20%/-30% |
| #A915AY-101M□ | 100μH ±20% | 0.1MHz | 430mA | 440mA | 0.667Ω+20%/-30% |

Operating temp. range (Self-temp. rise included): -40 to 85°C

Class of Magnetic Shield: Ferrite Core

Only for reflow soldering

*Isat: Rated Current based on Inductance change

*Itemp: Rated Current based on Temperature rise

Rated current (Isat) is specified when the decrease of the initial inductance value at 30%. Rated current (Itemp) is specified when temperature of the inductor is raised 40°C by DC current.

Continued on the following page. ↗

Continued from the preceding page. ↘

Inductance-Current Characteristics (Typ.)



Temperature Rise Characteristics (Typ.)



D53LC Low Rdc Series 2020 (5252) inch (mm)



| Packaging Code | Packaging | Minimum Quantity |
|----------------|------------------------|------------------|
| =P3 | ø330mm Embossed Taping | 2000 |

| Part Number (□: packaging code) | Inductance | Inductance Test Frequency | Rated Current (Isat)* | Rated Current (Itemp)* | DC Resistance |
|------------------------------------|------------|---------------------------|-----------------------|------------------------|-----------------|
| #A915BY-4R7M□ | 4.7µH ±20% | 0.1MHz | 1130mA | 2180mA | 0.029Ω+20%/-30% |
| #A915BY-6R8M□ | 6.8µH ±20% | 0.1MHz | 990mA | 1810mA | 0.042Ω+20%/-30% |
| #A915BY-100M□ | 10µH ±20% | 0.1MHz | 740mA | 1500mA | 0.056Ω+20%/-30% |
| #A915BY-150M□ | 15µH ±20% | 0.1MHz | 580mA | 1280mA | 0.081Ω+20%/-30% |
| #A915BY-220M□ | 22µH ±20% | 0.1MHz | 510mA | 1120mA | 0.112Ω+20%/-30% |
| #A915BY-330M□ | 33µH ±20% | 0.1MHz | 410mA | 880mA | 0.172Ω+20%/-30% |
| #A915BY-470M□ | 47µH ±20% | 0.1MHz | 340mA | 750mA | 0.224Ω+20%/-30% |
| #A915BY-680M□ | 68µH ±20% | 0.1MHz | 290mA | 640mA | 0.309Ω+20%/-30% |
| #A915BY-101M□ | 100µH ±20% | 0.1MHz | 260mA | 510mA | 0.474Ω+20%/-30% |
| #A915BY-151M□ | 150µH ±20% | 0.1MHz | 210mA | 380mA | 0.785Ω+20%/-30% |
| #A915BY-221M□ | 220µH ±20% | 0.1MHz | 180mA | 330mA | 0.995Ω+20%/-30% |

Operating temp. range (Self-temp. rise included): -40 to 85°C

Class of Magnetic Shield: Ferrite Core

Only for reflow soldering

*Isat: Rated Current based on Inductance change

*Itemp: Rated Current based on Temperature rise

Rated current (Isat) is specified when the decrease of the initial inductance value at 30%. Rated current (Itemp) is specified when temperature of the inductor is raised 40°C by DC current.

Inductance-Current Characteristics (Typ.)



Temperature Rise Characteristics (Typ.)



Inductors for Power Lines D53LC Low Rdc
 Inductors for General Circuits
 RF Inductors

LQH55DN_03 Series 2220 (5750) inch (mm)



| Packaging Code | Packaging | Minimum Quantity |
|----------------|------------------------|------------------|
| K | ø330mm Embossed Taping | 1500 |
| L | ø180mm Embossed Taping | 350 |

| Part Number (□: packaging code) | Inductance | Inductance Test Frequency | Rated Current | DC Resistance | S.R.F.* (min.) |
|------------------------------------|--------------|------------------------------|---------------|---------------|----------------|
| LQH55DNR12M03□ | 0.12μH ±20% | 1MHz | 6.0A | 0.007Ω±40% | 450MHz |
| LQH55DNR27M03□ | 0.27μH ±20% | 1MHz | 5.3A | 0.010Ω±40% | 300MHz |
| LQH55DNR47M03□ | 0.47μH ±20% | 1MHz | 4.8A | 0.013Ω±40% | 200MHz |
| LQH55DN1R0M03□ | 1.0μH ±20% | 1MHz | 4.0A | 0.019Ω±40% | 150MHz |
| LQH55DN1R5M03□ | 1.5μH ±20% | 1MHz | 3.7A | 0.022Ω±40% | 110MHz |
| LQH55DN2R2M03□ | 2.2μH ±20% | 1MHz | 3.2A | 0.029Ω±40% | 80MHz |
| LQH55DN3R3M03□ | 3.3μH ±20% | 1MHz | 2.9A | 0.036Ω±40% | 40MHz |
| LQH55DN4R7M03□ | 4.7μH ±20% | 1MHz | 2.7A | 0.041Ω±40% | 30MHz |
| LQH55DN6R8M03□ | 6.8μH ±20% | 1MHz | 2.0A | 0.074Ω±40% | 25MHz |
| LQH55DN100M03□ | 10μH ±20% | 1MHz | 1.7A | 0.093Ω±40% | 20MHz |
| LQH55DN150M03□ | 15μH ±20% | 1MHz | 1.4A | 0.15Ω±40% | 17MHz |
| LQH55DN220M03□ | 22μH ±20% | 1MHz | 1.2A | 0.19Ω±40% | 15MHz |
| LQH55DN330M03□ | 33μH ±20% | 1MHz | 0.9A | 0.32Ω±40% | 12MHz |
| LQH55DN470M03□ | 47μH ±20% | 1MHz | 0.8A | 0.40Ω±40% | 10MHz |
| LQH55DN680M03□ | 68μH ±20% | 1MHz | 0.64A | 0.67Ω±40% | 7.6MHz |
| LQH55DN101M03□ | 100μH ±20% | 100kHz | 0.56A | 0.86Ω±40% | 6.5MHz |
| LQH55DN151M03□ | 150μH ±20% | 100kHz | 0.42A | 1.9Ω±40% | 5.0MHz |
| LQH55DN221M03□ | 220μH ±20% | 100kHz | 0.32A | 2.4Ω±40% | 4.0MHz |
| LQH55DN331M03□ | 330μH ±20% | 100kHz | 0.27A | 4.4Ω±40% | 3.1MHz |
| LQH55DN471M03□ | 470μH ±20% | 100kHz | 0.24A | 5.4Ω±40% | 2.4MHz |
| LQH55DN681M03□ | 680μH ±20% | 100kHz | 0.19A | 8.1Ω±40% | 1.9MHz |
| LQH55DN102M03□ | 1000μH ±20% | 10kHz | 0.15A | 10.3Ω±40% | 1.7MHz |
| LQH55DN222M03□ | 2200μH ±20% | 10kHz | 0.10A | 21.5Ω±40% | 1.2MHz |
| LQH55DN472M03□ | 4700μH ±20% | 10kHz | 0.07A | 43.6Ω±40% | 0.8MHz |
| LQH55DN103M03□ | 10000μH ±20% | 10kHz | 0.05A | 100Ω±40% | 0.5MHz |

Operating temp. range: -40 to 80°C

Class of Magnetic Shield: No Shield

Only for reflow soldering

*S.R.F.: Self Resonant Frequency

When rated current is applied to the products, inductance will be within ±40% of initial inductance value. When rated current is applied to the products, the temperature rise caused by self-generated heat shall be limited to 40°C max.

Inductance-Frequency Characteristics (Typ.)



Inductance-Current Characteristics (Typ.)



Impedance-Frequency Characteristics (Typ.)



D63LCB Series 2424 (6060) inch (mm)



| Packaging Code | Packaging | Minimum Quantity |
|----------------|------------------------|------------------|
| =P3 | ø330mm Embossed Taping | 1500 |

| Part Number (□: packaging code) | Inductance | Inductance Test Frequency | Rated Current (Isat)* | Rated Current (Itemp)* | DC Resistance |
|------------------------------------|------------|------------------------------|-----------------------|------------------------|-----------------|
| #A921CY-1R0M□ | 1.0μH ±20% | 0.1MHz | 3590mA | 4520mA | 0.011Ω+20%/-30% |
| #A921CY-1R5M□ | 1.5μH ±20% | 0.1MHz | 2930mA | 3780mA | 0.013Ω+20%/-30% |
| #A921CY-2R2M□ | 2.2μH ±20% | 0.1MHz | 2420mA | 3510mA | 0.016Ω+20%/-30% |
| #A921CY-3R6M□ | 3.6μH ±20% | 0.1MHz | 1890mA | 3010mA | 0.021Ω+20%/-30% |
| #A921CY-4R7M□ | 4.7μH ±20% | 0.1MHz | 1660mA | 2580mA | 0.027Ω+20%/-30% |
| #A921CY-6R2M□ | 6.2μH ±20% | 0.1MHz | 1450mA | 2280mA | 0.032Ω+20%/-30% |
| #A921CY-100M□ | 10μH ±20% | 0.1MHz | 1140mA | 1910mA | 0.049Ω+20%/-30% |
| #A921CY-120M□ | 12μH ±20% | 0.1MHz | 1040mA | 1800mA | 0.052Ω+20%/-30% |
| #A921CY-150M□ | 15μH ±20% | 0.1MHz | 930mA | 1730mA | 0.062Ω+20%/-30% |
| #A921CY-180M□ | 18μH ±20% | 0.1MHz | 850mA | 1580mA | 0.074Ω+20%/-30% |
| #A921CY-220M□ | 22μH ±20% | 0.1MHz | 770mA | 1340mA | 0.095Ω+20%/-30% |
| #A921CY-270M□ | 27μH ±20% | 0.1MHz | 700mA | 1140mA | 0.120Ω+20%/-30% |
| #A921CY-330M□ | 33μH ±20% | 0.1MHz | 630mA | 1010mA | 0.140Ω+20%/-30% |
| #A921CY-390M□ | 39μH ±20% | 0.1MHz | 580mA | 980mA | 0.150Ω+20%/-30% |
| #A921CY-470M□ | 47μH ±20% | 0.1MHz | 530mA | 890mA | 0.185Ω+20%/-30% |
| #A921CY-560M□ | 56μH ±20% | 0.1MHz | 480mA | 820mA | 0.220Ω+20%/-30% |
| #A921CY-680M□ | 68μH ±20% | 0.1MHz | 440mA | 730mA | 0.270Ω+20%/-30% |
| #A921CY-820M□ | 82μH ±20% | 0.1MHz | 400mA | 640mA | 0.330Ω+20%/-30% |
| #A921CY-101M□ | 100μH ±20% | 0.1MHz | 360mA | 580mA | 0.415Ω+20%/-30% |
| #A921CY-151M□ | 150μH ±20% | 0.1MHz | 310mA | 440mA | 0.615Ω+20%/-30% |

Operating temp. range (Self-temp. rise included): -40 to 85°C

Class of Magnetic Shield: Ferrite Core

Only for reflow soldering

*Isat: Rated Current based on Inductance change

*Itemp: Rated Current based on Temperature rise

Rated current (Isat) is specified when the decrease of the initial inductance value at 30%. Rated current (Itemp) is specified when temperature of the inductor is raised 40°C by DC current.

Inductance-Current Characteristics (Typ.)



Temperature Rise Characteristics (Typ.)



DG6028C Series 2424 (6060) inch (mm)



| Packaging Code | Packaging | Minimum Quantity |
|----------------|------------------------|------------------|
| =P3 | ø330mm Embossed Taping | 2000 |

| Part Number (□: packaging code) | Inductance | Inductance Test Frequency | Rated Current (Isat)* | Rated Current (Itemp)* | DC Resistance |
|------------------------------------|------------|------------------------------|-----------------------|------------------------|---------------|
| 1253AY-1R0N□ | 1.0μH ±30% | 0.1MHz | 5300mA | 5800mA | 0.012Ω±20% |
| 1253AY-1R5N□ | 1.5μH ±30% | 0.1MHz | 4400mA | 5400mA | 0.016Ω±20% |
| 1253AY-2R2N□ | 2.2μH ±30% | 0.1MHz | 4000mA | 4800mA | 0.020Ω±20% |
| 1253AY-3R3N□ | 3.3μH ±30% | 0.1MHz | 2900mA | 4000mA | 0.028Ω±20% |
| 1253AY-4R7M□ | 4.7μH ±20% | 0.1MHz | 2600mA | 3600mA | 0.034Ω±20% |
| 1253AY-6R8M□ | 6.8μH ±20% | 0.1MHz | 2300mA | 3100mA | 0.047Ω±20% |
| 1253AY-100M□ | 10μH ±20% | 0.1MHz | 1900mA | 2500mA | 0.067Ω±20% |
| 1253AY-150M□ | 15μH ±20% | 0.1MHz | 1500mA | 2000mA | 0.094Ω±20% |
| 1253AY-220M□ | 22μH ±20% | 0.1MHz | 1300mA | 1700mA | 0.145Ω±20% |

Operating temp. range (Self-temp. rise included): -40 to 85°C

Class of Magnetic Shield: Magnetic Resin

Only for reflow soldering

*Isat: Rated Current based on Inductance change

*Itemp: Rated Current based on Temperature rise

Rated current (Isat) is specified when the decrease of the initial inductance value at 30%. Rated current (Itemp) is specified when temperature of the inductor is raised 40°C by DC current.

Inductance-Current Characteristics (Typ.)

Temperature Rise Characteristics (Typ.)

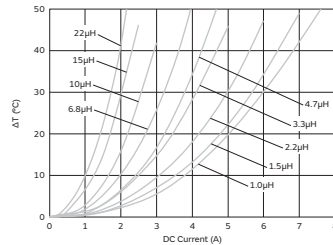

DG6045C Series 2424 (6060) inch (mm)



| Packaging Code | Packaging | Minimum Quantity |
|----------------|------------------------|------------------|
| =P3 | ø330mm Embossed Taping | 1500 |

Continued on the following page. ↗

Continued from the preceding page. ↘

| Part Number (□: packaging code) | Inductance | Inductance Test Frequency | Rated Current (Isat)* | Rated Current (Itemp)* | DC Resistance |
|------------------------------------|------------|------------------------------|-----------------------|------------------------|---------------|
| 1255AY-1R0N□ | 1.0μH ±30% | 0.1MHz | 9500mA | 6500mA | 0.010Ω±20% |
| 1255AY-1R2N□ | 1.2μH ±30% | 0.1MHz | 8400mA | 5900mA | 0.012Ω±20% |
| 1255AY-1R8N□ | 1.8μH ±30% | 0.1MHz | 6800mA | 5300mA | 0.014Ω±20% |
| 1255AY-2R2N□ | 2.2μH ±30% | 0.1MHz | 6300mA | 4700mA | 0.016Ω±20% |
| 1255AY-2R7N□ | 2.7μH ±30% | 0.1MHz | 5600mA | 4600mA | 0.018Ω±20% |
| 1255AY-3R3N□ | 3.3μH ±30% | 0.1MHz | 5200mA | 4400mA | 0.021Ω±20% |
| 1255AY-3R9N□ | 3.9μH ±30% | 0.1MHz | 4700mA | 4200mA | 0.022Ω±20% |
| 1255AY-4R7M□ | 4.7μH ±20% | 0.1MHz | 4500mA | 4000mA | 0.023Ω±20% |
| 1255AY-6R8M□ | 6.8μH ±20% | 0.1MHz | 3600mA | 3400mA | 0.036Ω±20% |
| 1255AY-100M□ | 10μH ±20% | 0.1MHz | 3100mA | 2900mA | 0.047Ω±20% |
| 1255AY-150M□ | 15μH ±20% | 0.1MHz | 2500mA | 2400mA | 0.063Ω±20% |
| 1255AY-220M□ | 22μH ±20% | 0.1MHz | 2000mA | 1900mA | 0.098Ω±20% |
| 1255AY-270M□ | 27μH ±20% | 0.1MHz | 1800mA | 1800mA | 0.135Ω±20% |
| 1255AY-330M□ | 33μH ±20% | 0.1MHz | 1700mA | 1500mA | 0.145Ω±20% |
| 1255AY-470M□ | 47μH ±20% | 0.1MHz | 1400mA | 1300mA | 0.210Ω±20% |
| 1255AY-680M□ | 68μH ±20% | 0.1MHz | 1200mA | 1000mA | 0.310Ω±20% |
| 1255AY-101M□ | 100μH ±20% | 0.1MHz | 900mA | 900mA | 0.460Ω±20% |

Operating temp. range (Self-temp. rise included): -40 to 85°C
 Class of Magnetic Shield: Magnetic Resin

Only for reflow soldering

*Isat: Rated Current based on Inductance change

*Itemp: Rated Current based on Temperature rise

Rated current (Isat) is specified when the decrease of the initial inductance value at 30%. Rated current (Itemp) is specified when temperature of the inductor is raised 40°C by DC current.

Inductance-Current Characteristics (Typ.)



Temperature Rise Characteristics (Typ.)



DG6050C Series 2424 (6060) inch (mm)



| Packaging Code | Packaging | Minimum Quantity |
|----------------|------------------------|------------------|
| =P3 | ø330mm Embossed Taping | 1500 |

Continued on the following page. ↗

Inductors for Power Lines DG6050C
 Inductors for General Circuits
 RF Inductors

Continued from the preceding page. ↘

| Part Number (□: packaging code) | Inductance | Inductance Test Frequency | Rated Current (I _{sat})* | Rated Current (I _{temp})* | DC Resistance |
|------------------------------------|------------|------------------------------|------------------------------------|-------------------------------------|---------------|
| 1264EY-1R2N□ | 1.2μH ±30% | 0.1MHz | 9800mA | 6300mA | 0.012Ω±20% |
| 1264EY-1R5N□ | 1.5μH ±30% | 0.1MHz | 8300mA | 5500mA | 0.014Ω±20% |
| 1264EY-2R2N□ | 2.2μH ±30% | 0.1MHz | 7800mA | 5300mA | 0.016Ω±20% |
| 1264EY-3R3N□ | 3.3μH ±30% | 0.1MHz | 6500mA | 4800mA | 0.021Ω±20% |
| 1264EY-4R7M□ | 4.7μH ±20% | 0.1MHz | 5400mA | 3700mA | 0.029Ω±20% |
| 1264EY-6R8M□ | 6.8μH ±20% | 0.1MHz | 4400mA | 3400mA | 0.035Ω±20% |
| 1264EY-100M□ | 10μH ±20% | 0.1MHz | 3500mA | 3100mA | 0.045Ω±20% |
| 1264EY-150M□ | 15μH ±20% | 0.1MHz | 3000mA | 2100mA | 0.087Ω±20% |
| 1264EY-220M□ | 22μH ±20% | 0.1MHz | 2300mA | 1800mA | 0.110Ω±20% |
| 1264EY-330M□ | 33μH ±20% | 0.1MHz | 1900mA | 1400mA | 0.170Ω±20% |
| 1264EY-470M□ | 47μH ±20% | 0.1MHz | 1700mA | 1200mA | 0.260Ω±20% |
| 1264EY-680M□ | 68μH ±20% | 0.1MHz | 1400mA | 1100mA | 0.325Ω±20% |
| 1264EY-101M□ | 100μH ±20% | 0.1MHz | 1200mA | 900mA | 0.460Ω±20% |

Operating temp. range (Self-temp. rise included): -40 to 85°C

Class of Magnetic Shield: Magnetic Resin

Only for reflow soldering

*I_{sat}: Rated Current based on Inductance change

*I_{temp}: Rated Current based on Temperature rise

Rated current (I_{sat}) is specified when the decrease of the initial inductance value at 30%. Rated current (I_{temp}) is specified when temperature of the inductor is raised 40°C by DC current.

Inductance-Current Characteristics (Typ.)



Temperature Rise Characteristics (Typ.)



LQH66SN_03 Series 2525 (6363) inch (mm)



| Packaging Code | Packaging | Minimum Quantity |
|----------------|------------------------|------------------|
| K | ø330mm Embossed Taping | 1500 |
| L | ø180mm Embossed Taping | 350 |

| Part Number (□: packaging code) | Inductance | Inductance Test Frequency | Rated Current | DC Resistance | S.R.F.* (min.) |
|------------------------------------|-------------|------------------------------|---------------|---------------|----------------|
| LQH66SNR27M03□ | 0.27μH ±20% | 1MHz | 6.0A | 0.007Ω±40% | 300MHz |
| LQH66SNR68M03□ | 0.68μH ±20% | 1MHz | 5.3A | 0.010Ω±40% | 180MHz |
| LQH66SN1R0M03□ | 1.0μH ±20% | 1MHz | 4.7A | 0.013Ω±40% | 150MHz |
| LQH66SN1R5M03□ | 1.5μH ±20% | 1MHz | 3.8A | 0.016Ω±40% | 110MHz |
| LQH66SN2R2M03□ | 2.2μH ±20% | 1MHz | 3.3A | 0.019Ω±40% | 80MHz |

Operating temp. range: -40 to 80°C

Class of Magnetic Shield: Ferrite Core

Only for reflow soldering

*S.R.F.: Self Resonant Frequency

When rated current is applied to the products, inductance will be within ±10% of initial inductance value. When rated current is applied to the products, the temperature rise caused by self-generated heat shall be limited to 40°C max.

Continued on the following page. ↗

Continued from the preceding page. ↘

| Part Number (□: packaging code) | Inductance | Inductance Test Frequency | Rated Current | DC Resistance | S.R.F.* (min.) |
|------------------------------------|--------------|------------------------------|---------------|---------------|----------------|
| LQH66SN3R3M03□ | 3.3μH ±20% | 1MHz | 2.6A | 0.022Ω±40% | 40MHz |
| LQH66SN4R7M03□ | 4.7μH ±20% | 1MHz | 2.2A | 0.025Ω±40% | 30MHz |
| LQH66SN6R8M03□ | 6.8μH ±20% | 1MHz | 1.8A | 0.029Ω±40% | 25MHz |
| LQH66SN100M03□ | 10μH ±20% | 1MHz | 1.6A | 0.036Ω±40% | 20MHz |
| LQH66SN150M03□ | 15μH ±20% | 1MHz | 1.3A | 0.069Ω±40% | 17MHz |
| LQH66SN220M03□ | 22μH ±20% | 1MHz | 1.1A | 0.087Ω±40% | 15MHz |
| LQH66SN330M03□ | 33μH ±20% | 1MHz | 0.86A | 0.14Ω±40% | 12MHz |
| LQH66SN470M03□ | 47μH ±20% | 1MHz | 0.76A | 0.17Ω±40% | 10MHz |
| LQH66SN680M03□ | 68μH ±20% | 1MHz | 0.60A | 0.29Ω±40% | 7.6MHz |
| LQH66SN101M03□ | 100μH ±20% | 100kHz | 0.52A | 0.36Ω±40% | 6.5MHz |
| LQH66SN151M03□ | 150μH ±20% | 100kHz | 0.42A | 0.63Ω±40% | 5.0MHz |
| LQH66SN221M03□ | 220μH ±20% | 100kHz | 0.35A | 0.79Ω±40% | 4.0MHz |
| LQH66SN331M03□ | 330μH ±20% | 100kHz | 0.28A | 1.8Ω±40% | 3.2MHz |
| LQH66SN471M03□ | 470μH ±20% | 100kHz | 0.24A | 2.2Ω±40% | 2.5MHz |
| LQH66SN681M03□ | 680μH ±20% | 100kHz | 0.20A | 3.9Ω±40% | 2.0MHz |
| LQH66SN102M03□ | 1000μH ±20% | 10kHz | 0.16A | 4.9Ω±40% | 1.7MHz |
| LQH66SN222M03□ | 2200μH ±20% | 10kHz | 0.10A | 9.4Ω±40% | 1.2MHz |
| LQH66SN472M03□ | 4700μH ±20% | 10kHz | 0.07A | 19.5Ω±40% | 0.8MHz |
| LQH66SN103M03□ | 10000μH ±20% | 10kHz | 0.05A | 39.7Ω±40% | 0.5MHz |

Operating temp. range: -40 to 80°C
 Class of Magnetic Shield: Ferrite Core
 Only for reflow soldering
 *S.R.F.: Self Resonant Frequency

When rated current is applied to the products, inductance will be within ±10% of initial inductance value. When rated current is applied to the products, the temperature rise caused by self-generated heat shall be limited to 40°C max.

Inductance-Frequency Characteristics (Typ.)



Inductance-Current Characteristics (Typ.)

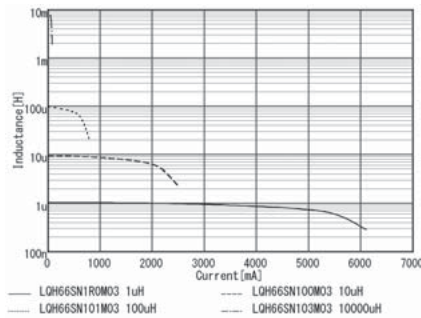

Impedance-Frequency Characteristics (Typ.)



DS75LC Series 2929 (7373) inch (mm)



| Packaging Code | Packaging | Minimum Quantity |
|----------------|------------------------|------------------|
| =P3 | ø330mm Embossed Taping | 1000 |

Continued on the following page. ↗

Continued from the preceding page. ↘

| Part Number (□: packaging code) | Inductance | Inductance Test Frequency | Rated Current (Isat)* | Rated Current (Itemp)* | Max. of DC Resistance |
|------------------------------------|------------|------------------------------|-----------------------|------------------------|-----------------------|
| B1047AS-1R0N□ | 1.0μH ±30% | 0.1MHz | 9200mA | 6400mA | 0.012Ω |
| B1047AS-1R5N□ | 1.5μH ±30% | 0.1MHz | 7700mA | 5900mA | 0.014Ω |
| B1047AS-2R2N□ | 2.2μH ±30% | 0.1MHz | 6500mA | 5500mA | 0.016Ω |
| B1047AS-2R7N□ | 2.7μH ±30% | 0.1MHz | 5600mA | 5100mA | 0.018Ω |
| B1047AS-3R6N□ | 3.6μH ±30% | 0.1MHz | 5000mA | 4400mA | 0.023Ω |
| B1047AS-4R7N□ | 4.7μH ±30% | 0.1MHz | 4500mA | 4100mA | 0.026Ω |
| B1047AS-5R6N□ | 5.6μH ±30% | 0.1MHz | 4000mA | 3500mA | 0.032Ω |
| B1047AS-6R8N□ | 6.8μH ±30% | 0.1MHz | 3600mA | 3400mA | 0.036Ω |
| B1047AS-8R2N□ | 8.2μH ±30% | 0.1MHz | 3200mA | 3000mA | 0.042Ω |
| B1047AS-100M□ | 10μH ±20% | 0.1MHz | 2900mA | 2700mA | 0.053Ω |
| B1047AS-120M□ | 12μH ±20% | 0.1MHz | 2700mA | 2400mA | 0.063Ω |
| B1047AS-150M□ | 15μH ±20% | 0.1MHz | 2400mA | 2200mA | 0.071Ω |
| B1047AS-180M□ | 18μH ±20% | 0.1MHz | 2200mA | 1900mA | 0.110Ω |
| B1047AS-220M□ | 22μH ±20% | 0.1MHz | 2000mA | 1800mA | 0.120Ω |
| B1047AS-270M□ | 27μH ±20% | 0.1MHz | 1800mA | 1600mA | 0.130Ω |
| B1047AS-330M□ | 33μH ±20% | 0.1MHz | 1640mA | 1500mA | 0.170Ω |
| B1047AS-390M□ | 39μH ±20% | 0.1MHz | 1500mA | 1400mA | 0.180Ω |
| B1047AS-470M□ | 47μH ±20% | 0.1MHz | 1380mA | 1300mA | 0.200Ω |
| B1047AS-560M□ | 56μH ±20% | 0.1MHz | 1240mA | 1200mA | 0.230Ω |
| B1047AS-680M□ | 68μH ±20% | 0.1MHz | 1130mA | 1000mA | 0.280Ω |
| B1047AS-820M□ | 82μH ±20% | 0.1MHz | 1000mA | 940mA | 0.320Ω |
| B1047AS-101M□ | 100μH ±20% | 0.1MHz | 940mA | 770mA | 0.460Ω |
| B1047AS-151M□ | 150μH ±20% | 0.1MHz | 760mA | 600mA | 0.710Ω |
| B1047AS-221M□ | 220μH ±20% | 0.1MHz | 620mA | 470mA | 1.100Ω |
| B1047AS-331M□ | 330μH ±20% | 0.1MHz | 510mA | 410mA | 1.400Ω |
| B1047AS-471M□ | 470μH ±20% | 0.1MHz | 430mA | 370mA | 1.700Ω |

Operating temp. range (Self-temp. rise included): -40 to 85°C

Class of Magnetic Shield: Ferrite Core

Only for reflow soldering

*Isat: Rated Current based on Inductance change

*Itemp: Rated Current based on Temperature rise

Rated current (Isat) is specified when the decrease of the initial inductance value at 30%. Rated current (Itemp) is specified when temperature of the inductor is raised 40°C by DC current.

Inductance-Current Characteristics (Typ.)



Temperature Rise Characteristics (Typ.)



DEM8030C Series 3131 (8080) inch (mm)



| Packaging Code | Packaging | Minimum Quantity |
|----------------|------------------------|------------------|
| =P3 | ø330mm Embossed Taping | 1000 |

| Part Number (□: packaging code) | Inductance | Inductance Test Frequency | Rated Current (Isat)* | Rated Current (Itemp)* | DC Resistance |
|------------------------------------|------------|---------------------------|-----------------------|------------------------|---------------|
| 1273AS-H-1R5N□ | 1.5μH ±30% | 0.1MHz | 7500mA | 7300mA | 0.0083Ω±20% |
| 1273AS-H-2R2N□ | 2.2μH ±30% | 0.1MHz | 6200mA | 6500mA | 0.0110Ω±20% |
| 1273AS-H-3R3N□ | 3.3μH ±30% | 0.1MHz | 5200mA | 5400mA | 0.0160Ω±20% |
| 1273AS-H-4R7N□ | 4.7μH ±30% | 0.1MHz | 4400mA | 4900mA | 0.0190Ω±20% |
| 1273AS-H-6R8N□ | 6.8μH ±30% | 0.1MHz | 3400mA | 3700mA | 0.0310Ω±20% |
| 1273AS-H-100M□ | 10μH ±20% | 0.1MHz | 2900mA | 3100mA | 0.0450Ω±20% |
| 1273AS-H-150M□ | 15μH ±20% | 0.1MHz | 2400mA | 2600mA | 0.0650Ω±20% |
| 1273AS-H-220M□ | 22μH ±20% | 0.1MHz | 2000mA | 2000mA | 0.1050Ω±20% |
| 1273AS-H-330M□ | 33μH ±20% | 0.1MHz | 1600mA | 1900mA | 0.1450Ω±20% |
| 1273AS-H-470M□ | 47μH ±20% | 0.1MHz | 1300mA | 1300mA | 0.2410Ω±20% |

Operating temp. range (Self-temp. rise included): -40 to 85°C

Class of Magnetic Shield: Ferrite Core

Only for reflow soldering

*Isat: Rated Current based on Inductance change

*Itemp: Rated Current based on Temperature rise

Rated current (Isat) is specified when the decrease of the initial inductance value at 30%. Rated current (Itemp) is specified when temperature of the inductor is raised 40°C by DC current.

Inductance-Current Characteristics (Typ.)

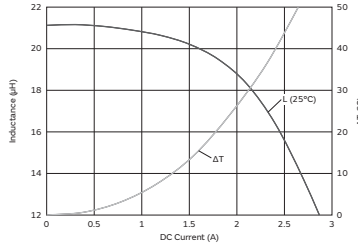

Temperature Rise Characteristics (Typ.)

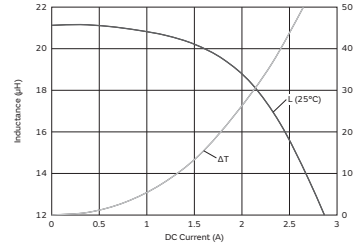

DEM8040C Series 3131 (8080) inch (mm)



| Packaging Code | Packaging | Minimum Quantity |
|----------------|------------------------|------------------|
| =P3 | ø330mm Embossed Taping | 1000 |

Continued on the following page. ↗

Continued from the preceding page. ↘

| Part Number (□: packaging code) | Inductance | Inductance Test Frequency | Rated Current (Isat)* | Rated Current (Itemp)* | DC Resistance |
|------------------------------------|------------|------------------------------|-----------------------|------------------------|---------------|
| 1248AS-H-1R5N□ | 1.5μH ±30% | 0.1MHz | 10000mA | 8000mA | 0.0084Ω±20% |
| 1248AS-H-2R2N□ | 2.2μH ±30% | 0.1MHz | 8600mA | 7000mA | 0.0110Ω±20% |
| 1248AS-H-3R3N□ | 3.3μH ±30% | 0.1MHz | 7200mA | 5600mA | 0.0160Ω±20% |
| 1248AS-H-4R7N□ | 4.7μH ±30% | 0.1MHz | 6200mA | 5300mA | 0.0190Ω±20% |
| 1248AS-H-6R8N□ | 6.8μH ±30% | 0.1MHz | 4800mA | 4200mA | 0.0300Ω±20% |
| 1248AS-H-100M□ | 10μH ±20% | 0.1MHz | 4100mA | 3400mA | 0.0440Ω±20% |
| 1248AS-H-150M□ | 15μH ±20% | 0.1MHz | 3400mA | 2700mA | 0.0650Ω±20% |
| 1248AS-H-220M□ | 22μH ±20% | 0.1MHz | 2800mA | 2200mA | 0.1050Ω±20% |
| 1248AS-H-330M□ | 33μH ±20% | 0.1MHz | 2400mA | 1800mA | 0.1400Ω±20% |

Operating temp. range (Self-temp. rise included): -40 to 85°C

Class of Magnetic Shield: Ferrite Core

Only for reflow soldering

*Isat: Rated Current based on Inductance change

*Itemp: Rated Current based on Temperature rise

Rated current (Isat) is specified when the decrease of the initial inductance value at 30%. Rated current (Itemp) is specified when temperature of the inductor is raised 40°C by DC current.

Inductance-Current Characteristics (Typ.)



Temperature Rise Characteristics (Typ.)



DEM8045C Series 3131 (8080) inch (mm)



| Packaging Code | Packaging | Minimum Quantity |
|----------------|------------------------|------------------|
| =P3 | ø330mm Embossed Taping | 1000 |

| Part Number (□: packaging code) | Inductance | Inductance Test Frequency | Rated Current (Isat)* | Rated Current (Itemp)* | DC Resistance |
|------------------------------------|------------|------------------------------|-----------------------|------------------------|---------------|
| 1217AS-H-1R5N□ | 1.5μH ±30% | 0.1MHz | 11200mA | 9400mA | 0.0065Ω±20% |
| 1217AS-H-2R2N□ | 2.2μH ±30% | 0.1MHz | 9300mA | 8700mA | 0.0083Ω±20% |
| 1217AS-H-3R3N□ | 3.3μH ±30% | 0.1MHz | 7700mA | 6800mA | 0.0120Ω±20% |
| 1217AS-H-4R7N□ | 4.7μH ±30% | 0.1MHz | 6700mA | 6300mA | 0.0150Ω±20% |
| 1217AS-H-5R6N□ | 5.6μH ±30% | 0.1MHz | 6100mA | 5400mA | 0.0190Ω±20% |
| 1217AS-H-6R8N□ | 6.8μH ±30% | 0.1MHz | 5200mA | 4800mA | 0.0230Ω±20% |
| 1217AS-H-8R2M□ | 8.2μH ±20% | 0.1MHz | 4800mA | 4500mA | 0.0280Ω±20% |
| 1217AS-H-100M□ | 10μH ±20% | 0.1MHz | 4300mA | 3900mA | 0.0330Ω±20% |
| 1217AS-H-150M□ | 15μH ±20% | 0.1MHz | 3300mA | 3500mA | 0.0440Ω±20% |

Operating temp. range (Self-temp. rise included): -40 to 85°C

Class of Magnetic Shield: Ferrite Core

Only for reflow soldering

*Isat: Rated Current based on Inductance change

*Itemp: Rated Current based on Temperature rise

Rated current (Isat) is specified when the decrease of the initial inductance value at 30%. Rated current (Itemp) is specified when temperature of the inductor is raised 40°C by DC current.

Continued on the following page. ↗

Continued from the preceding page. ↘

| Part Number (□: packaging code) | Inductance | Inductance Test Frequency | Rated Current (Isat)* | Rated Current (Itemp)* | DC Resistance |
|------------------------------------|------------|------------------------------|-----------------------|------------------------|---------------|
| 1217AS-H-180M□ | 18μH ±20% | 0.1MHz | 3200mA | 2900mA | 0.0640Ω±20% |
| 1217AS-H-220M□ | 22μH ±20% | 0.1MHz | 2900mA | 2400mA | 0.0780Ω±20% |
| 1217AS-H-330M□ | 33μH ±20% | 0.1MHz | 2300mA | 2200mA | 0.1100Ω±20% |
| 1217AS-H-470M□ | 47μH ±20% | 0.1MHz | 2100mA | 1800mA | 0.1700Ω±20% |

Operating temp. range (Self-temp. rise included): -40 to 85°C

Class of Magnetic Shield: Ferrite Core

Only for reflow soldering

*Isat: Rated Current based on Inductance change

*Itemp: Rated Current based on Temperature rise

Rated current (Isat) is specified when the decrease of the initial inductance value at 30%. Rated current (Itemp) is specified when temperature of the inductor is raised 40°C by DC current.

Inductance-Current Characteristics (Typ.)



Temperature Rise Characteristics (Typ.)



DG8040C Series 3131 (8080) inch (mm)



| Packaging Code | Packaging | Minimum Quantity |
|----------------|------------------------|------------------|
| =P3 | ø330mm Embossed Taping | 1000 |

| Part Number (□: packaging code) | Inductance | Inductance Test Frequency | Rated Current (Isat)* | Rated Current (Itemp)* | DC Resistance |
|------------------------------------|------------|------------------------------|-----------------------|------------------------|---------------|
| 1267AY-1R0N□ | 1.0μH ±30% | 0.1MHz | 10400mA | 8400mA | 0.007Ω±20% |
| 1267AY-1R5N□ | 1.5μH ±30% | 0.1MHz | 8200mA | 7300mA | 0.009Ω±20% |
| 1267AY-2R2N□ | 2.2μH ±30% | 0.1MHz | 7400mA | 6500mA | 0.011Ω±20% |
| 1267AY-3R3N□ | 3.3μH ±30% | 0.1MHz | 6100mA | 6100mA | 0.013Ω±20% |
| 1267AY-4R7N□ | 4.7μH ±30% | 0.1MHz | 5100mA | 5300mA | 0.017Ω±20% |
| 1267AY-6R8N□ | 6.8μH ±30% | 0.1MHz | 4000mA | 4500mA | 0.022Ω±20% |
| 1267AY-100M□ | 10μH ±20% | 0.1MHz | 3300mA | 3900mA | 0.033Ω±20% |
| 1267AY-150M□ | 15μH ±20% | 0.1MHz | 2600mA | 3200mA | 0.049Ω±20% |
| 1267AY-220M□ | 22μH ±20% | 0.1MHz | 2300mA | 2800mA | 0.062Ω±20% |
| 1267AY-330M□ | 33μH ±20% | 0.1MHz | 1900mA | 2200mA | 0.100Ω±20% |
| 1267AY-470M□ | 47μH ±20% | 0.1MHz | 1600mA | 1900mA | 0.140Ω±20% |
| 1267AY-680M□ | 68μH ±20% | 0.1MHz | 1300mA | 1600mA | 0.200Ω±20% |
| 1267AY-101M□ | 100μH ±20% | 0.1MHz | 1100mA | 1300mA | 0.280Ω±20% |

Operating temp. range (Self-temp. rise included): -40 to 85°C

Class of Magnetic Shield: Magnetic Resin

Only for reflow soldering

*Isat: Rated Current based on Inductance change

*Itemp: Rated Current based on Temperature rise

Rated current (Isat) is specified when the decrease of the initial inductance value at 30%. Rated current (Itemp) is specified when temperature of the inductor is raised 40°C by DC current.

Continued on the following page. ↗

Continued from the preceding page. ↘

Inductance-Current Characteristics (Typ.)



Temperature Rise Characteristics (Typ.)



DEM10050C Series 3939 (100100) inch (mm)



| Packaging Code | Packaging | Minimum Quantity |
|----------------|------------------------|------------------|
| =P3 | ø330mm Embossed Taping | 500 |

| Part Number (□: packaging code) | Inductance | Inductance Test Frequency | Rated Current (Isat)* | Rated Current (Itemp)* | DC Resistance |
|------------------------------------|------------|---------------------------|-----------------------|------------------------|---------------|
| 1274AS-H-1R5N□ | 1.5µH ±30% | 0.1MHz | 15300mA | 8900mA | 0.0064Ω±20% |
| 1274AS-H-2R2N□ | 2.2µH ±30% | 0.1MHz | 12600mA | 8000mA | 0.0080Ω±20% |
| 1274AS-H-3R3N□ | 3.3µH ±30% | 0.1MHz | 10800mA | 7400mA | 0.0095Ω±20% |
| 1274AS-H-4R7N□ | 4.7µH ±30% | 0.1MHz | 9500mA | 6700mA | 0.0112Ω±20% |
| 1274AS-H-5R6N□ | 5.6µH ±30% | 0.1MHz | 8300mA | 6300mA | 0.0152Ω±20% |
| 1274AS-H-6R8N□ | 6.8µH ±30% | 0.1MHz | 7500mA | 5400mA | 0.0177Ω±20% |
| 1274AS-H-8R2M□ | 8.2µH ±20% | 0.1MHz | 6800mA | 4800mA | 0.0220Ω±20% |
| 1274AS-H-100M□ | 10µH ±20% | 0.1MHz | 6200mA | 4400mA | 0.0253Ω±20% |
| 1274AS-H-150M□ | 15µH ±20% | 0.1MHz | 5100mA | 3900mA | 0.0352Ω±20% |
| 1274AS-H-220M□ | 22µH ±20% | 0.1MHz | 4200mA | 2900mA | 0.0567Ω±20% |
| 1274AS-H-330M□ | 33µH ±20% | 0.1MHz | 3500mA | 2500mA | 0.0780Ω±20% |

Operating temp. range (Self-temp. rise included): -40 to 85°C

Class of Magnetic Shield: Ferrite Core

Only for reflow soldering

*Isat: Rated Current based on Inductance change

*Itemp: Rated Current based on Temperature rise

Rated current (Isat) is specified when the decrease of the initial inductance value at 30%. Rated current (Itemp) is specified when temperature of the inductor is raised 40°C by DC current.

Inductance-Current Characteristics (Typ.)



Temperature Rise Characteristics (Typ.)



DEM10050C

Inductors for Power Lines

Inductors for General Circuits

RF Inductors

DEM10050C_DD Series 3939 (100100) inch (mm)



| Packaging Code | Packaging | Minimum Quantity |
|----------------|------------------------|------------------|
| =P3 | ø330mm Embossed Taping | 500 |

| Part Number (□: packaging code) | Inductance | Inductance Test Frequency | Rated Current (Isat)* | Rated Current (Itemp)* | DC Resistance |
|------------------------------------|------------|------------------------------|-----------------------|------------------------|---------------|
| DD1274AS-H-1R5N□ | 1.5μH ±30% | 0.1MHz | 15300mA | 8900mA | 0.0064Ω±20% |
| DD1274AS-H-2R2N□ | 2.2μH ±30% | 0.1MHz | 12600mA | 8000mA | 0.0080Ω±20% |
| DD1274AS-H-3R3N□ | 3.3μH ±30% | 0.1MHz | 10800mA | 7400mA | 0.0095Ω±20% |
| DD1274AS-H-4R7N□ | 4.7μH ±30% | 0.1MHz | 9500mA | 6700mA | 0.0112Ω±20% |
| DD1274AS-H-5R6N□ | 5.6μH ±30% | 0.1MHz | 8300mA | 6300mA | 0.0152Ω±20% |
| DD1274AS-H-6R8N□ | 6.8μH ±30% | 0.1MHz | 7500mA | 5400mA | 0.0177Ω±20% |
| DD1274AS-H-8R2M□ | 8.2μH ±20% | 0.1MHz | 6800mA | 4800mA | 0.0220Ω±20% |
| DD1274AS-H-100M□ | 10μH ±20% | 0.1MHz | 6200mA | 4400mA | 0.0253Ω±20% |
| DD1274AS-H-150M□ | 15μH ±20% | 0.1MHz | 5100mA | 3900mA | 0.0352Ω±20% |
| DD1274AS-H-220M□ | 22μH ±20% | 0.1MHz | 4200mA | 2900mA | 0.0567Ω±20% |
| DD1274AS-H-330M□ | 33μH ±20% | 0.1MHz | 3500mA | 2500mA | 0.0780Ω±20% |

Operating temp. range (Self-temp. rise included): -40 to 105°C

Class of Magnetic Shield: Ferrite Core

Only for reflow soldering

*Isat: Rated Current based on Inductance change

*Itemp: Rated Current based on Temperature rise

Rated current (Isat) is specified when the decrease of the initial inductance value at 30%. Rated current (Itemp) is specified when temperature of the inductor is raised 40°C by DC current.

Inductance-Current Characteristics (Typ.)



Temperature Rise Characteristics (Typ.)



Notice (Rating)

Max. current (DC, AC) as function of ambient temperature (derating curve).

Derating of Rated Current



DS104C2 Series 4040 (101101) inch (mm)



| Packaging Code | Packaging | Minimum Quantity |
|----------------|------------------------|------------------|
| =P3 | ø330mm Embossed Taping | 500 |

Continued on the following page. ↗

Continued from the preceding page. ↘

| Part Number (□: packaging code) | Inductance | Inductance Test Frequency | Rated Current (Isat)* | Rated Current (Itemp)* | Max. of DC Resistance |
|------------------------------------|------------|------------------------------|-----------------------|------------------------|-----------------------|
| #B952AS-H-1R1N□ | 1.1μH ±30% | 0.1MHz | 11700mA | 6000mA | 0.011Ω |
| #B952AS-H-1R8N□ | 1.8μH ±30% | 0.1MHz | 8700mA | 5400mA | 0.014Ω |
| #B952AS-H-2R7N□ | 2.7μH ±30% | 0.1MHz | 7300mA | 4900mA | 0.016Ω |
| #B952AS-H-3R9N□ | 3.9μH ±30% | 0.1MHz | 5800mA | 4600mA | 0.018Ω |
| #B952AS-H-5R1N□ | 5.1μH ±30% | 0.1MHz | 4900mA | 3800mA | 0.026Ω |
| #B952AS-H-6R8N□ | 6.8μH ±30% | 0.1MHz | 4500mA | 3100mA | 0.035Ω |
| #B952AS-H-8R2N□ | 8.2μH ±30% | 0.1MHz | 4100mA | 2900mA | 0.040Ω |
| #B952AS-H-100M□ | 10μH ±20% | 0.1MHz | 3600mA | 2700mA | 0.044Ω |
| #B952AS-H-120M□ | 12μH ±20% | 0.1MHz | 3300mA | 2500mA | 0.051Ω |
| #B952AS-H-150M□ | 15μH ±20% | 0.1MHz | 3100mA | 2300mA | 0.062Ω |
| #B952AS-H-180M□ | 18μH ±20% | 0.1MHz | 2700mA | 2000mA | 0.079Ω |
| #B952AS-H-220M□ | 22μH ±20% | 0.1MHz | 2400mA | 1900mA | 0.087Ω |
| #B952AS-H-270M□ | 27μH ±20% | 0.1MHz | 2200mA | 1800mA | 0.100Ω |
| #B952AS-H-330M□ | 33μH ±20% | 0.1MHz | 2000mA | 1600mA | 0.125Ω |
| #B952AS-H-390M□ | 39μH ±20% | 0.1MHz | 1800mA | 1400mA | 0.150Ω |
| #B952AS-H-470M□ | 47μH ±20% | 0.1MHz | 1700mA | 1300mA | 0.175Ω |
| #B952AS-H-560M□ | 56μH ±20% | 0.1MHz | 1500mA | 1200mA | 0.195Ω |
| #B952AS-H-680M□ | 68μH ±20% | 0.1MHz | 1300mA | 1100mA | 0.240Ω |
| #B952AS-H-820M□ | 82μH ±20% | 0.1MHz | 1200mA | 1000mA | 0.295Ω |
| #B952AS-H-101M□ | 100μH ±20% | 0.1MHz | 1100mA | 900mA | 0.380Ω |
| #B952AS-H-121M□ | 120μH ±20% | 0.1MHz | 970mA | 800mA | 0.460Ω |

Operating temp. range (Self-temp. rise included): -40 to 85°C

Class of Magnetic Shield: Ferrite Core

Only for reflow soldering

*Isat: Rated Current based on Inductance change

*Itemp: Rated Current based on Temperature rise

Rated current (Isat) is specified when the decrease of the initial inductance value at 10%. Rated current (Itemp) is specified when temperature of the inductor is raised 40°C by DC current.

Inductance-Current Characteristics (Typ.)



Temperature Rise Characteristics (Typ.)



DS106C2 Series 4040 (101101) inch (mm)



| Packaging Code | Packaging | Minimum Quantity |
|----------------|------------------------|------------------|
| =P3 | ø330mm Embossed Taping | 500 |

Continued on the following page. ↗

Continued from the preceding page. ↘

| Part Number (□: packaging code) | Inductance | Inductance Test Frequency | Rated Current (Isat)* | Rated Current (Itemp)* | Max. of DC Resistance |
|------------------------------------|------------|------------------------------|-----------------------|------------------------|-----------------------|
| #B966AS-1R2N□ | 1.2μH ±30% | 0.1MHz | 12000mA | 7200mA | 0.011Ω |
| #B966AS-1R8N□ | 1.8μH ±30% | 0.1MHz | 9800mA | 6700mA | 0.014Ω |
| #B966AS-2R7N□ | 2.7μH ±30% | 0.1MHz | 8100mA | 6100mA | 0.015Ω |
| #B966AS-3R9N□ | 3.9μH ±30% | 0.1MHz | 7100mA | 5600mA | 0.017Ω |
| #B966AS-4R7N□ | 4.7μH ±30% | 0.1MHz | 6100mA | 5400mA | 0.018Ω |
| #B966AS-6R8N□ | 6.8μH ±30% | 0.1MHz | 5200mA | 5000mA | 0.021Ω |
| #B966AS-8R2N□ | 8.2μH ±30% | 0.1MHz | 4800mA | 4600mA | 0.024Ω |
| #B966AS-100M□ | 10μH ±20% | 0.1MHz | 4400mA | 4300mA | 0.028Ω |
| #B966AS-120M□ | 12μH ±20% | 0.1MHz | 3900mA | 3700mA | 0.035Ω |
| #B966AS-160M□ | 16μH ±20% | 0.1MHz | 3300mA | 2700mA | 0.060Ω |
| #B966BS-180M□ | 18μH ±20% | 0.1MHz | 2800mA | 2600mA | 0.060Ω |
| #B966BS-220M□ | 22μH ±20% | 0.1MHz | 2700mA | 2500mA | 0.065Ω |
| #B966BS-270M□ | 27μH ±20% | 0.1MHz | 2400mA | 2300mA | 0.074Ω |
| #B966BS-330M□ | 33μH ±20% | 0.1MHz | 2100mA | 2200mA | 0.083Ω |
| #B966BS-390M□ | 39μH ±20% | 0.1MHz | 2100mA | 2200mA | 0.093Ω |
| #B966BS-470M□ | 47μH ±20% | 0.1MHz | 1800mA | 1800mA | 0.120Ω |
| #B966BS-560M□ | 56μH ±20% | 0.1MHz | 1600mA | 1600mA | 0.145Ω |
| #B966BS-680M□ | 68μH ±20% | 0.1MHz | 1400mA | 1400mA | 0.190Ω |
| #B966BS-101M□ | 100μH ±20% | 0.1MHz | 1200mA | 1200mA | 0.255Ω |
| #B966BS-151M□ | 150μH ±20% | 0.1MHz | 1000mA | 970mA | 0.385Ω |
| #B966BS-221M□ | 220μH ±20% | 0.1MHz | 840mA | 760mA | 0.610Ω |
| #B966BS-271M□ | 270μH ±20% | 0.1MHz | 750mA | 710mA | 0.690Ω |
| #B966BS-331M□ | 330μH ±20% | 0.1MHz | 690mA | 680mA | 0.760Ω |

Operating temp. range (Self-temp. rise included): -40 to 85°C

Class of Magnetic Shield: Ferrite Core

Only for reflow soldering

*Isat: Rated Current based on Inductance change

*Itemp: Rated Current based on Temperature rise

Rated current (Isat) is specified when the decrease of the initial inductance value at 10%. Rated current (Itemp) is specified when temperature of the inductor is raised 40°C by DC current.

Inductance-Current Characteristics (Typ.)



Temperature Rise Characteristics (Typ.)



DS126C2 Series 4949 (125125) inch (mm)



| Packaging Code | Packaging | Minimum Quantity |
|----------------|------------------------|------------------|
| =P3 | ø330mm Embossed Taping | 500 |

Continued on the following page. ↗

Inductors for Power Lines DS126C2
 Inductors for General Circuits
 RF Inductors

Continued from the preceding page. ↘

| Part Number (□: packaging code) | Inductance | Inductance Test Frequency | Rated Current (Isat)* | Rated Current (Itemp)* | Max. of DC Resistance |
|------------------------------------|------------|------------------------------|-----------------------|------------------------|-----------------------|
| #B953AS-1R7N□ | 1.7μH ±30% | 0.1MHz | 11800mA | 7700mA | 0.010Ω |
| #B953AS-2R7N□ | 2.7μH ±30% | 0.1MHz | 9000mA | 7000mA | 0.011Ω |
| #B953AS-3R9N□ | 3.9μH ±30% | 0.1MHz | 7900mA | 6000mA | 0.014Ω |
| #B953AS-5R6N□ | 5.6μH ±30% | 0.1MHz | 6800mA | 5600mA | 0.016Ω |
| #B953AS-7R5N□ | 7.5μH ±30% | 0.1MHz | 5700mA | 5100mA | 0.017Ω |
| #B953AS-100M□ | 10μH ±20% | 0.1MHz | 5500mA | 4400mA | 0.023Ω |
| #B953AS-120M□ | 12μH ±20% | 0.1MHz | 5000mA | 4000mA | 0.027Ω |
| #B953AS-150M□ | 15μH ±20% | 0.1MHz | 4500mA | 3600mA | 0.032Ω |
| #B953AS-180M□ | 18μH ±20% | 0.1MHz | 4100mA | 3200mA | 0.040Ω |
| #B953AS-220M□ | 22μH ±20% | 0.1MHz | 3600mA | 2900mA | 0.046Ω |
| #B953AS-270M□ | 27μH ±20% | 0.1MHz | 3200mA | 2800mA | 0.050Ω |
| #B953AS-330M□ | 33μH ±20% | 0.1MHz | 3000mA | 2400mA | 0.064Ω |
| #B953AS-390M□ | 39μH ±20% | 0.1MHz | 2700mA | 2200mA | 0.074Ω |
| #B953AS-470M□ | 47μH ±20% | 0.1MHz | 2400mA | 2100mA | 0.082Ω |
| #B953AS-560M□ | 56μH ±20% | 0.1MHz | 2000mA | 1900mA | 0.105Ω |
| #B953AS-680M□ | 68μH ±20% | 0.1MHz | 1700mA | 1700mA | 0.120Ω |
| #B953AS-820M□ | 82μH ±20% | 0.1MHz | 1600mA | 1600mA | 0.145Ω |
| #B953AS-101M□ | 100μH ±20% | 0.1MHz | 1500mA | 1400mA | 0.170Ω |
| #B953AS-121M□ | 120μH ±20% | 0.1MHz | 1300mA | 1300mA | 0.185Ω |
| #B953AS-151M□ | 150μH ±20% | 0.1MHz | 1200mA | 1200mA | 0.235Ω |
| #B953AS-181M□ | 180μH ±20% | 0.1MHz | 1100mA | 1100mA | 0.290Ω |
| #B953AS-221M□ | 220μH ±20% | 0.1MHz | 1000mA | 1000mA | 0.350Ω |
| #B953AS-271M□ | 270μH ±20% | 0.1MHz | 930mA | 920mA | 0.415Ω |
| #B953AS-331M□ | 330μH ±20% | 0.1MHz | 830mA | 830mA | 0.495Ω |
| #B953AS-391M□ | 390μH ±20% | 0.1MHz | 760mA | 770mA | 0.610Ω |
| #B953AS-471M□ | 470μH ±20% | 0.1MHz | 670mA | 700mA | 0.705Ω |
| #B953AS-561M□ | 560μH ±20% | 0.1MHz | 620mA | 640mA | 0.900Ω |
| #B953AS-681M□ | 680μH ±20% | 0.1MHz | 550mA | 580mA | 1.120Ω |

Operating temp. range (Self-temp. rise included): -40 to 85°C

Class of Magnetic Shield: Ferrite Core

Only for reflow soldering

*Isat: Rated Current based on Inductance change

*Itemp: Rated Current based on Temperature rise

Rated current (Isat) is specified when the decrease of the initial inductance value at 10%. Rated current (Itemp) is specified when temperature of the inductor is raised 40°C by DC current.

Inductance-Current Characteristics (Typ.)



Temperature Rise Characteristics (Typ.)



LQM18FN_00 Series 0603 (1608) inch (mm)



(in mm)

| Packaging Code | Packaging | Minimum Quantity |
|----------------|---------------------|------------------|
| D | ø180mm Paper Taping | 4000 |
| J | ø330mm Paper Taping | 10000 |
| B | Packing in Bulk | 1000 |

| Part Number (□: packaging code) | Inductance | Inductance Test Frequency | Rated Current | DC Resistance | S.R.F.* (min.) |
|------------------------------------|------------|---------------------------|---------------|---------------|----------------|
| LQM18FN1R0M00 □ | 1.0μH ±20% | 1MHz | 150mA | 0.20Ω±30% | 120MHz |
| LQM18FN2R2M00 □ | 2.2μH ±20% | 1MHz | 120mA | 0.40Ω±30% | 80MHz |
| LQM18FN4R7M00 □ | 4.7μH ±20% | 1MHz | 80mA | 0.60Ω±30% | 50MHz |
| LQM18FN100M00 □ | 10μH ±20% | 1MHz | 50mA | 0.90Ω±30% | 30MHz |

Operating temp. range: -55 to 125°C
 Class of Magnetic Shield: Ferrite Core
 *S.R.F.: Self Resonant Frequency

Inductance-Frequency Characteristics (Typ.)



Inductance-Current Characteristics (Typ.)



Impedance-Frequency Characteristics (Typ.)



LQM18PN_B0 Series 0603 (1608) inch (mm)



(in mm)

| Packaging Code | Packaging | Minimum Quantity |
|----------------|------------------------|------------------|
| L | ø180mm Embossed Taping | 4000 |
| B | Packing in Bulk | 1000 |

Continued on the following page. ↗

Continued from the preceding page. ↘

| Part Number (□: packaging code) | Inductance | Inductance Test Frequency | Rated Current | DC Resistance | S.R.F.* (min.) |
|------------------------------------|------------|------------------------------|---------------|---------------|----------------|
| LQM18PN1R5NBO□ | 1.5μH ±30% | 1MHz | 600mA | 0.35Ω±25% | 50MHz |

Operating temp. range: -55 to 125°C
 Class of Magnetic Shield: Ferrite Core
 *S.R.F.: Self Resonant Frequency

Inductance-Frequency Characteristics (Typ.)



Inductance-Current Characteristics (Typ.)



Temperature Rise Characteristics (Typ.)



LQM18PN_C0 Series 0603 (1608) inch (mm)



| Packaging Code | Packaging | Minimum Quantity |
|----------------|------------------------|------------------|
| L | ø180mm Embossed Taping | 4000 |
| B | Packing in Bulk | 1000 |

(in mm)

| Part Number (□: packaging code) | Inductance | Inductance Test Frequency | Rated Current | DC Resistance | S.R.F.* (min.) |
|------------------------------------|-------------|------------------------------|---------------|---------------|----------------|
| LQM18PNR47NCO□ | 0.47μH ±30% | 1MHz | 850mA | 0.15Ω±25% | 50MHz |
| LQM18PN1R0NCO□ | 1.0μH ±30% | 1MHz | 750mA | 0.20Ω±25% | 50MHz |
| LQM18PN1R5NCO□ | 1.5μH ±30% | 1MHz | 720mA | 0.22Ω±25% | 50MHz |
| LQM18PN1R8NCO□ | 1.8μH ±30% | 1MHz | 700mA | 0.24Ω±25% | 50MHz |
| LQM18PN2R2NCO□ | 2.2μH ±30% | 1MHz | 700mA | 0.24Ω±25% | 50MHz |

Operating temp. range: -55 to 125°C
 Class of Magnetic Shield: Ferrite Core
 *S.R.F.: Self Resonant Frequency

Inductance-Frequency Characteristics (Typ.)



Inductance-Current Characteristics (Typ.)



Temperature Rise Characteristics (Typ.)



LQM18PN_D0 Series 0603 (1608) inch (mm)



(in mm)

| Packaging Code | Packaging | Minimum Quantity |
|----------------|---------------------|------------------|
| D | ø180mm Paper Taping | 4000 |
| B | Packing in Bulk | 1000 |

| Part Number (□: packaging code) | Inductance | Inductance Test Frequency | Rated Current | DC Resistance | S.R.F.* (min.) |
|------------------------------------|------------|---------------------------|---------------|---------------|----------------|
| LQM18PN2R5NDO □ | 2.5μH ±30% | 1MHz | 700mA | 0.24Ω±25% | 60MHz |

Operating temp. range: -40 to 85°C
 Class of Magnetic Shield: Ferrite Core
 *S.R.F.: Self Resonant Frequency

Inductance-Frequency Characteristics (Typ.)



Inductance-Current Characteristics (Typ.)



Temperature Rise Characteristics (Typ.)



LQM18PN_DH Series 0603 (1608) inch (mm)



(in mm)

| Packaging Code | Packaging | Minimum Quantity |
|----------------|---------------------|------------------|
| D | ø180mm Paper Taping | 4000 |
| B | Packing in Bulk | 1000 |

| Part Number (□: packaging code) | Inductance | Inductance Test Frequency | Rated Current (Isat)* | Rated Current (Itemp)* | DC Resistance | S.R.F.* (min.) |
|------------------------------------|------------|---------------------------|--------------------------|--------------------------|---------------|----------------|
| LQM18PN2R2MDH □ | 2.2μH ±20% | 1MHz | 250mA(Max) / 300mA(Typ.) | 650mA(Max) / 800mA(Typ.) | 0.38Ω(typ.) | 60MHz |

Operating temp. range: -40 to 85°C
 Class of Magnetic Shield: Ferrite Core
 Only for reflow soldering
 *Isat: Rated Current based on Inductance change
 *Itemp: Rated Current based on Temperature rise
 *S.R.F.: Self Resonant Frequency

When rated current is applied to the products, inductance will be within ±30% of initial inductance value range. When rated current is applied to the products, the temperature rise caused by self-generated heat shall be limited to 40°C max. Keep the temperature (ambient temperature plus self-generation of heat) under 125°C.

Continued on the following page. ↗

Continued from the preceding page. ↘

Inductance-Frequency Characteristics (Typ.)



Inductance-Current Characteristics (Typ.)



Temperature Rise Characteristics (Typ.)



LQM18PN_F0 Series 0603 (1608) inch (mm)



| Packaging Code | Packaging | Minimum Quantity |
|----------------|------------------------|------------------|
| L | ø180mm Embossed Taping | 4000 |
| B | Packing in Bulk | 1000 |

| Part Number (□: packaging code) | Inductance | Inductance Test Frequency | Rated Current | DC Resistance | S.R.F.* (min.) |
|------------------------------------|------------|---------------------------|---------------|---------------|----------------|
| LQM18PN1RONFO□ | 1.0μH ±30% | 1MHz | 600mA | 0.28Ω±25% | 50MHz |

Operating temp. range: -55 to 125°C
 Class of Magnetic Shield: Ferrite Core
 *S.R.F.: Self Resonant Frequency

Inductance-Frequency Characteristics (Typ.)



Inductance-Current Characteristics (Typ.)



Temperature Rise Characteristics (Typ.)



LQM18PN_F0
 Inductors for Power Lines

Inductors for General Circuits

RF Inductors

LQM18PN_FH Series 0603 (1608) inch (mm)



| Packaging Code | Packaging | Minimum Quantity |
|----------------|---------------------|------------------|
| D | ø180mm Paper Taping | 4000 |
| B | Packing in Bulk | 1000 |

| Part Number (□: packaging code) | Inductance | Inductance Test Frequency | Rated Current (Isat)* | Rated Current (Itemp)* | DC Resistance | S.R.F.* (min.) |
|------------------------------------|-------------|---------------------------|--------------------------|--------------------------|---------------|----------------|
| LQM18PNR47MFH □ | 0.47μH ±20% | 1MHz | 1.3A(Max.) / 1.5A(Typ.) | 1.4A(Max.) / 1.7A(Typ.) | 0.1Ω(typ.) | 100MHz |
| LQM18PN1R0MFH □ | 1.0μH ±20% | 1MHz | 0.55A(Max.) / 0.7A(Typ.) | 1.3A(Max.) / 1.45A(Typ.) | 0.13Ω(typ.) | 100MHz |
| LQM18PN1R5MFH □ | 1.5μH ±20% | 1MHz | 0.4A(Max.) / 0.5A(Typ.) | 1.1A(Max.) / 1.25A(Typ.) | 0.17Ω(typ.) | 80MHz |
| LQM18PN2R2MFH □ | 2.2μH ±20% | 1MHz | 0.3A(Max.) / 0.35A(Typ.) | 0.7A(Max.) / 0.9A(Typ.) | 0.38Ω(typ.) | 80MHz |

Operating temp. range: -40 to 85°C
 Class of Magnetic Shield: Ferrite Core

Only for reflow soldering

*Isat: Rated Current based on Inductance change

*Itemp: Rated Current based on Temperature rise

*S.R.F.: Self Resonant Frequency

When rated current is applied to the products, inductance will be within ±30% of initial inductance value range. When rated current is applied to the products, the temperature rise caused by self-generated heat shall be limited to 40°C max. Keep the temperature (ambient temperature plus self-generation of heat) under 125°C.

Inductance-Frequency Characteristics (Typ.)



Inductance-Current Characteristics (Typ.)



Temperature Rise Characteristics (Typ.)



LQM18PN_FR Series 0603 (1608) inch (mm)



| Packaging Code | Packaging | Minimum Quantity |
|----------------|------------------------|------------------|
| L | ø180mm Embossed Taping | 4000 |
| B | Packing in Bulk | 1000 |

Continued on the following page. ↗

Continued from the preceding page. ↘

| Part Number (□: packaging code) | Inductance | Inductance Test Frequency | Rated Current | DC Resistance | S.R.F.* (min.) |
|------------------------------------|-------------|------------------------------|---------------|---------------|----------------|
| LQM18PNR22NFR□ | 0.22μH ±30% | 1MHz | 1250mA | 0.11Ω±25% | 100MHz |
| LQM18PNR47NFR□ | 0.47μH ±30% | 1MHz | 1100mA | 0.15Ω±25% | 100MHz |
| LQM18PN1R0MFRR□ | 1.0μH ±20% | 1MHz | 950mA | 0.20Ω±25% | 100MHz |
| LQM18PN1R5MFRR□ | 1.5μH ±20% | 1MHz | 800mA | 0.23Ω±25% | 100MHz |
| LQM18PN2R2MFRR□ | 2.2μH ±20% | 1MHz | 750mA | 0.30Ω±25% | 70MHz |
| LQM18PN3R3MFRR□ | 3.3μH ±20% | 1MHz | 700mA | 0.35Ω±25% | 60MHz |
| LQM18PN4R7MFRR□ | 4.7μH ±20% | 1MHz | 620mA | 0.44Ω±25% | 40MHz |

Operating temp. range: -40 to 85°C
 Class of Magnetic Shield: Ferrite Core
 *S.R.F.: Self Resonant Frequency

Inductance-Frequency Characteristics (Typ.)



Inductance-Current Characteristics (Typ.)



Temperature Rise Characteristics (Typ.)



LQM18PN_GH Series 0603 (1608) inch (mm)



(in mm)

| Packaging Code | Packaging | Minimum Quantity |
|----------------|---------------------|------------------|
| D | ø180mm Paper Taping | 4000 |
| B | Packing in Bulk | 1000 |

| Part Number (□: packaging code) | Inductance | Inductance Test Frequency | Rated Current (Isat)* | Rated Current (Itemp)* | DC Resistance | S.R.F.* (min.) |
|------------------------------------|------------|------------------------------|---------------------------|---------------------------|---------------|----------------|
| LQM18PN1R0MGH□ | 1.0μH ±20% | 1MHz | 0.8A(Max.) / 0.9A(Typ.) | 1.05A(Max.) / 1.15A(Typ.) | 0.2Ω(typ.) | 100MHz |
| LQM18PN2R2MGH□ | 2.2μH ±20% | 1MHz | 0.25A(Max.) / 0.35A(Typ.) | 1.05A(Max.) / 1.15A(Typ.) | 0.2Ω(typ.) | 70MHz |
| LQM18PN3R3MGH□ | 3.3μH ±20% | 1MHz | 0.15A(Max.) / 0.2A(Typ.) | 1.05A(Max.) / 1.15A(Typ.) | 0.2Ω(typ.) | 30MHz |

Operating temp. range: -40 to 85°C
 Class of Magnetic Shield: Ferrite Core
 Only for reflow soldering

*Isat: Rated Current based on Inductance change
 *Itemp: Rated Current based on Temperature rise
 *S.R.F.: Self Resonant Frequency

When rated current is applied to the products, inductance will be within ±30% of initial inductance value. When rated current is applied to the products, the temperature rise caused by self-generated heat shall be limited to 40°C max. Keep the temperature (ambient temperature plus self-generation of heat) under 125°C.

Continued on the following page. ↗

Continued from the preceding page. ↘

Inductance-Frequency Characteristics (Typ.)



Inductance-Current Characteristics (Typ.)



Temperature Rise Characteristics (Typ.)



LQM18PW_CH Series 0603 (1608) inch (mm)



| Dimension of T | Inductance: 1.0 to 2.2μH | |
|----------------|--------------------------|-----------|
| | | 0.50±0.15 |
| | Inductance: 2.5μH | |
| | | |

(in mm)

| Packaging Code | Packaging | Minimum Quantity |
|----------------|---------------------|------------------|
| D | ø180mm Paper Taping | 4000 |
| B | Packing in Bulk | 1000 |

| Part Number (□: packaging code) | Inductance | Inductance Test Frequency | Rated Current (Isat)* | Rated Current (Itemp)* | DC Resistance | S.R.F.* (min.) |
|------------------------------------|------------|---------------------------|--------------------------|--------------------------|---------------|----------------|
| LQM18PW1R0MCH□ | 1.0μH ±20% | 1MHz | 0.60A(Max) / 0.70A(Typ.) | 0.95A(Max) / 1.05A(Typ.) | 0.23Ω(typ.) | 70MHz |
| LQM18PW2R2MCH□ | 2.2μH ±20% | 1MHz | 0.20A(Max) / 0.30A(Typ.) | 0.75A(Max) / 0.85A(Typ.) | 0.38Ω(typ.) | 50MHz |
| LQM18PW2R5NCH□ | 2.5μH ±30% | 1MHz | 0.10A(Max) / 0.15A(Typ.) | 0.90A(Max) / 1.00A(Typ.) | 0.24Ω(typ.) | 50MHz |

Operating temp. range: -40 to 85°C

Class of Magnetic Shield: Ferrite Core

Only for reflow soldering

*Isat: Rated Current based on Inductance change

*Itemp: Rated Current based on Temperature rise

*S.R.F.: Self Resonant Frequency

When rated current is applied to the products, inductance will be within ±30% of initial inductance value range. When rated current is applied to the products, the temperature rise caused by self-generated heat shall be limited to 40°C max. Keep the temperature (ambient temperature plus self-generation of heat) under 125°C.

Inductance-Frequency Characteristics (Typ.)



Inductance-Current Characteristics (Typ.)



Temperature Rise Characteristics (Typ.)



LQM21DN_00 Series 0805 (2012) inch (mm)



| | | |
|----------------|-------------------------|----------|
| Dimension of t | Inductance: 1.0 to 10μH | 0.85±0.2 |
| | Inductance: 22 to 47μH | 1.25±0.2 |

(Inductance: 1.0μH to 10μH)

| Packaging Code | Packaging | Minimum Quantity |
|----------------|---------------------|------------------|
| D | ø180mm Paper Taping | 4000 |
| J | ø330mm Paper Taping | 10000 |
| B | Packing in Bulk | 1000 |

(Inductance: 22μH to 47μH)

| Packaging Code | Packaging | Minimum Quantity |
|----------------|------------------------|------------------|
| K | ø330mm Embossed Taping | 10000 |
| L | ø180mm Embossed Taping | 3000 |
| B | Packing in Bulk | 1000 |

| Part Number (□: packaging code) | Inductance | Inductance Test Frequency | Rated Current | Max. of DC Resistance | S.R.F.* (min.) |
|------------------------------------|------------|---------------------------|---------------|-----------------------|----------------|
| LQM21DN1R0N00□ | 1.0μH ±30% | 1MHz | 60mA | 0.10Ω | 75MHz |
| LQM21DN2R2N00□ | 2.2μH ±30% | 1MHz | 40mA | 0.17Ω | 50MHz |
| LQM21DN4R7N00□ | 4.7μH ±30% | 1MHz | 30mA | 0.30Ω | 35MHz |
| LQM21DN100N00□ | 10μH ±30% | 1MHz | 15mA | 0.50Ω | 24MHz |
| LQM21DN220N00□ | 22μH ±30% | 1MHz | 13mA | 0.65Ω | 16MHz |
| LQM21DN470N00□ | 47μH ±30% | 1MHz | 7mA | 1.20Ω | 7.5MHz |

Operating temp. range: -40 to 85°C
 Class of Magnetic Shield: Ferrite Core
 *S.R.F.: Self Resonant Frequency

Inductance-Frequency Characteristics (Typ.)



Inductance-Current Characteristics (Typ.)



Impedance-Frequency Characteristics (Typ.)



LQM21FN_00 Series 0805 (2012) inch (mm)



| | | |
|----------------|--------------------------|----------|
| Dimension of t | Inductance: 1.0 to 2.2μH | 0.85±0.2 |
| | Inductance: 4.7 to 47μH | 1.25±0.2 |

(Inductance: 1.0μH to 2.2μH)

| Packaging Code | Packaging | Minimum Quantity |
|----------------|---------------------|------------------|
| D | ø180mm Paper Taping | 4000 |
| J | ø330mm Paper Taping | 10000 |
| B | Packing in Bulk | 1000 |

(Inductance: 4.7μH to 47μH)

| Packaging Code | Packaging | Minimum Quantity |
|----------------|------------------------|------------------|
| K | ø330mm Embossed Taping | 10000 |
| L | ø180mm Embossed Taping | 3000 |
| B | Packing in Bulk | 1000 |

Continued on the following page. ↗

Continued from the preceding page. ↘

| Part Number (□: packaging code) | Inductance | Inductance Test Frequency | Rated Current | DC Resistance | S.R.F.* (min.) |
|------------------------------------|------------|------------------------------|---------------|---------------|----------------|
| LQM21FN1R0N00□ | 1.0μH ±30% | 1MHz | 220mA | 0.20Ω±30% | 105MHz |
| LQM21FN2R2N00□ | 2.2μH ±30% | 1MHz | 150mA | 0.28Ω±30% | 70MHz |
| LQM21FN4R7N00□ | 4.7μH ±30% | 1MHz | 80mA | 0.30Ω±30% | 25MHz |
| LQM21FN100N00□ | 10μH ±30% | 1MHz | 60mA | 0.50Ω±30% | 15MHz |
| LQM21FN220N00□ | 22μH ±30% | 1MHz | 13mA | 0.35Ω±30% | 15MHz |
| LQM21FN470N00□ | 47μH ±30% | 1MHz | 7mA | 0.60Ω±30% | 7.5MHz |

Operating temp. range: -40 to 85°C
 Class of Magnetic Shield: Ferrite Core
 *S.R.F.: Self Resonant Frequency

Inductance-Frequency Characteristics (Typ.)



Inductance-Current Characteristics (Typ.)



Impedance-Frequency Characteristics (Typ.)



LQM21FN_70 Series 0805 (2012) inch (mm)



(in mm)

| Packaging Code | Packaging | Minimum Quantity |
|----------------|------------------------|------------------|
| L | ø180mm Embossed Taping | 3000 |
| B | Packing in Bulk | 1000 |

| Part Number (□: packaging code) | Inductance | Inductance Test Frequency | Rated Current | DC Resistance | S.R.F.* (min.) |
|------------------------------------|------------|------------------------------|---------------|---------------|----------------|
| LQM21FN4R7M70□ | 4.7μH ±20% | 1MHz | 120mA | 0.35Ω±30% | 25MHz |
| LQM21FN100M70□ | 10μH ±20% | 1MHz | 100mA | 0.60Ω±30% | 15MHz |

Operating temp. range: -55 to 125°C
 Class of Magnetic Shield: Ferrite Core
 *S.R.F.: Self Resonant Frequency

Inductance-Frequency Characteristics (Typ.)



Inductance-Current Characteristics (Typ.)



Impedance-Frequency Characteristics (Typ.)



Inductors for Power Lines LQM21FN_70
 Inductors for General Circuits
 RF Inductors

LQM21FN_80 Series 0805 (2012) inch (mm)



| Packaging Code | Packaging | Minimum Quantity |
|----------------|------------------------|------------------|
| K | ø330mm Embossed Taping | 10000 |
| L | ø180mm Embossed Taping | 3000 |
| B | Packing in Bulk | 1000 |

| Part Number (□: packaging code) | Inductance | Inductance Test Frequency | Rated Current | DC Resistance | S.R.F.* (min.) |
|------------------------------------|------------|---------------------------|---------------|---------------|----------------|
| LQM21FN4R7M80 □ | 4.7μH ±20% | 1MHz | 120mA | 0.18Ω±30% | 25MHz |
| LQM21FN100M80 □ | 10μH ±20% | 1MHz | 100mA | 0.30Ω±30% | 15MHz |

Operating temp. range (Self-temp. rise not included): -55 to 125°C
 Class of Magnetic Shield: Ferrite Core
 *S.R.F.: Self Resonant Frequency

Inductance-Frequency Characteristics (Typ.)



Inductance-Current Characteristics (Typ.)



Impedance-Frequency Characteristics (Typ.)



LQM21PN_C0 Series 0805 (2012) inch (mm)



| Packaging Code | Packaging | Minimum Quantity |
|----------------|---------------------|------------------|
| D | ø180mm Paper Taping | 4000 |
| B | Packing in Bulk | 1000 |

Continued on the following page. ↗

LQM21FN_80
 Inductors for Power Lines

Inductors for General Circuits

RF Inductors

Continued from the preceding page. ↘

| Part Number (□: packaging code) | Inductance | Inductance Test Frequency | Rated Current | DC Resistance | S.R.F.* (min.) |
|------------------------------------|-------------|------------------------------|--|---------------|----------------|
| LQM21PNR47MCO□ | 0.47μH ±20% | 1MHz | 1.1A(Ambient temp.85°C) 0.82A(Ambient temp.125°C) | 0.12Ω±25% | 100MHz |
| LQM21PN1R0MCO□ | 1.0μH ±20% | 1MHz | 0.8A(Ambient temp.85°C) 0.60A(Ambient temp.125°C) | 0.19Ω±25% | 90MHz |
| LQM21PN1R5MCO□ | 1.5μH ±20% | 1MHz | 0.7A(Ambient temp.85°C) 0.52A(Ambient temp.125°C) | 0.26Ω±25% | 70MHz |
| LQM21PN2R2MCO□ | 2.2μH ±20% | 1MHz | 0.6A(Ambient temp.85°C) 0.45A(Ambient temp.125°C) | 0.34Ω±25% | 50MHz |

Operating temp. range: -55 to 125°C

Class of Magnetic Shield: Ferrite Core

*S.R.F.: Self Resonant Frequency

In operating temperatures exceeding +85°C, derating of current is necessary for the LQM21P_C0 series. Please apply the derating curve shown in the chart according to the operating temperature. Please consider "Notice (Rating)." When rated current is applied to the products, the temperature rise caused by self-generated heat shall be limited to 40°C max.

Inductance-Frequency Characteristics (Typ.)



Inductance-Current Characteristics (Typ.)



Temperature Rise Characteristics (Typ.)



Notice (Rating)

In operating temperatures exceeding +85°C, derating of current is necessary for this series. Please apply the derating curve shown in the chart according to the operating temperature.

Derating of Rated Current



LQM21PN_CA Series 0805 (2012) inch (mm)



(in mm)

| Packaging Code | Packaging | Minimum Quantity |
|----------------|---------------------|------------------|
| D | ø180mm Paper Taping | 3000 |
| B | Packing in Bulk | 1000 |

Continued on the following page. ↗

Continued from the preceding page. ↘

| Part Number (□: packaging code) | Inductance | Inductance Test Frequency | Rated Current (Isat)* | Rated Current (Itemp)* | DC Resistance | S.R.F.* (min.) |
|------------------------------------|------------|---------------------------|---------------------------|---------------------------|---------------|----------------|
| LQM21PN2R2MCA□ | 2.2μH ±20% | 1MHz | 0.28A(Max.) / 0.30A(Typ.) | 1.05A(Max.) / 1.30A(Typ.) | 0.2Ω(typ.) | 40MHz |

Operating temp. range: -40 to 85°C
 Class of Magnetic Shield: Ferrite Core

Only for reflow soldering

*Isat: Rated Current based on Inductance change

*Itemp: Rated Current based on Temperature rise

*S.R.F.: Self Resonant Frequency

When rated current is applied to the products, inductance will be within ±30% of initial inductance value range. When rated current is applied to the products, the temperature rise caused by self-generated heat shall be limited to 40°C max. Keep the temperature (ambient temperature plus self-generation of heat) under 125°C.

Inductance-Frequency Characteristics (Typ.)



Inductance-Current Characteristics (Typ.)



Temperature Rise Characteristics (Typ.)

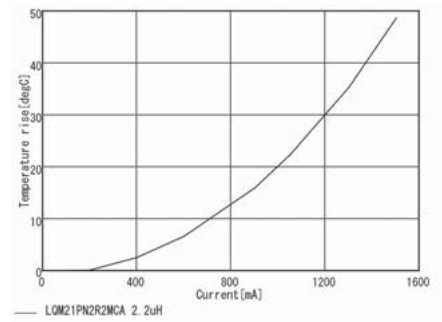

LQM21PN_CH Series 0805 (2012) inch (mm)



| Packaging Code | Packaging | Minimum Quantity |
|----------------|---------------------|------------------|
| D | ø180mm Paper Taping | 3000 |
| J | ø330mm Paper Taping | 10000 |
| B | Packing in Bulk | 1000 |

| Part Number (□: packaging code) | Inductance | Inductance Test Frequency | Rated Current (Isat)* | Rated Current (Itemp)* | DC Resistance | S.R.F.* (min.) |
|------------------------------------|-------------|---------------------------|--------------------------|--------------------------|---------------|----------------|
| LQM21PNR47MCH□ | 0.47μH ±20% | 1MHz | 1.6A(Max.) / 1.8A(Typ.) | 1.4A(Max.) / 1.8A(Typ.) | 0.11Ω(typ.) | 80MHz |
| LQM21PNR82MCH□ | 0.82μH ±20% | 1MHz | 0.7A(Max.) / 0.9A(Typ.) | 1.3A(Max.) / 1.6A(Typ.) | 0.13Ω(typ.) | 60MHz |
| LQM21PN1R0MCH□ | 1.0μH ±20% | 1MHz | 0.35A(Max.) / 0.5A(Typ.) | 1.2A(Max.) / 1.5A(Typ.) | 0.15Ω(typ.) | 50MHz |
| LQM21PN1R5MCH□ | 1.5μH ±20% | 1MHz | 0.25A(Max.) / 0.4A(Typ.) | 1.1A(Max.) / 1.4A(Typ.) | 0.17Ω(typ.) | 40MHz |
| LQM21PN2R2MCH□ | 2.2μH ±20% | 1MHz | 0.18A(Max.) / 0.2A(Typ.) | 1.05A(Max.) / 1.3A(Typ.) | 0.2Ω(typ.) | 30MHz |

Operating temp. range: -40 to 85°C

Class of Magnetic Shield: Ferrite Core

Only for reflow soldering

*Isat: Rated Current based on Inductance change

*Itemp: Rated Current based on Temperature rise

*S.R.F.: Self Resonant Frequency

When rated current is applied to the products, inductance will be within ±30% of initial inductance value range. When rated current is applied to the products, the temperature rise caused by self-generated heat shall be limited to 40°C max. Keep the temperature (ambient temperature plus self-generation of heat) under 125°C.

Continued on the following page. ↗

LQM21PN_CH
 Inductors for Power Lines

Inductors for General Circuits

RF Inductors

Continued from the preceding page. ↘

Inductance-Frequency Characteristics (Typ.)



Inductance-Current Characteristics (Typ.)



Temperature Rise Characteristics (Typ.)



LQM21PN_EH Series 0805 (2012) inch (mm)



(in mm)

| Packaging Code | Packaging | Minimum Quantity |
|----------------|---------------------|------------------|
| D | ø180mm Paper Taping | 3000 |
| B | Packing in Bulk | 1000 |

| Part Number (□: packaging code) | Inductance | Inductance Test Frequency | Rated Current (Isat)* | Rated Current (Itemp)* | DC Resistance | S.R.F.* (min.) |
|------------------------------------|-------------|---------------------------|--------------------------|-------------------------|---------------|----------------|
| LQM21PNR24MEH□ | 0.24μH ±20% | 1MHz | 2.8A(Max.) / 3.1A(Typ.) | 2.4A(Max.) / 2.9A(Typ.) | 0.04Ω(typ.) | 130MHz |
| LQM21PNR47MEH□ | 0.47μH ±20% | 1MHz | 1.5A(Max.) / 1.8A(Typ.) | 1.9A(Max.) / 2.4A(Typ.) | 0.06Ω(typ.) | 80MHz |
| LQM21PN1R0MEH□ | 1.0μH ±20% | 1MHz | 0.8A(Max.) / 1A(Typ.) | 1.6A(Max.) / 2A(Typ.) | 0.085Ω(typ.) | 50MHz |
| LQM21PN1R5MEH□ | 1.5μH ±20% | 1MHz | 0.4A(Max.) / 0.55A(Typ.) | 1.5A(Max.) / 1.8A(Typ.) | 0.1Ω(typ.) | 40MHz |
| LQM21PN2R2MEH□ | 2.2μH ±20% | 1MHz | 0.3A(Max.) / 0.45A(Typ.) | 1.1A(Max.) / 1.4A(Typ.) | 0.175Ω(typ.) | 30MHz |

Operating temp. range: -40 to 85°C

Class of Magnetic Shield: Ferrite Core

Only for reflow soldering

*Isat: Rated Current based on Inductance change

*Itemp: Rated Current based on Temperature rise

*S.R.F.: Self Resonant Frequency

When rated current is applied to the products, inductance will be within ±30% of initial inductance value range. When rated current is applied to the products, the temperature rise caused by self-generated heat shall be limited to 40°C max. Keep the temperature (ambient temperature plus self-generation of heat) under 125°C.

Inductance-Frequency Characteristics (Typ.)



Inductance-Current Characteristics (Typ.)



Temperature Rise Characteristics (Typ.)



LQM21PN_G0 Series 0805 (2012) inch (mm)



| Packaging Code | Packaging | Minimum Quantity |
|----------------|---------------------|------------------|
| D | ø180mm Paper Taping | 4000 |
| B | Packing in Bulk | 1000 |

| Part Number (□: packaging code) | Inductance | Inductance Test Frequency | Rated Current | DC Resistance | S.R.F.* (min.) |
|------------------------------------|-------------|---------------------------|--|---------------|----------------|
| LQM21PNR47MG0□ | 0.47μH ±20% | 1MHz | 1.3A(Ambient temp.85°C) 0.95A(Ambient temp.125°C) | 0.075Ω(typ.) | 100MHz |
| LQM21PNR54MG0□ | 0.54μH ±20% | 1MHz | 1.3A(Ambient temp.85°C) 0.95A(Ambient temp.125°C) | 0.075Ω(typ.) | 100MHz |
| LQM21PN3R3MG0□ | 3.3μH ±20% | 1MHz | 0.8A(Ambient temp.85°C) 0.55A(Ambient temp.125°C) | 0.165Ω(typ.) | 30MHz |
| LQM21PN3R3NG0□ | 3.3μH ±30% | 1MHz | 0.8A(Ambient temp.85°C) 0.55A(Ambient temp.125°C) | 0.165Ω(typ.) | 30MHz |

Operating temp. range: -55 to 125°C
 Class of Magnetic Shield: Ferrite Core
 *S.R.F.: Self Resonant Frequency

In operating temperatures exceeding +85°C, derating of current is necessary for the LQM21P_G0 series. Please apply the derating curve shown in the chart according to the operating temperature. Please consider "Notice (Rating)." When rated current is applied to the products, the temperature rise caused by self-generated heat shall be limited to 40°C max.

Inductance-Frequency Characteristics (Typ.)



Inductance-Current Characteristics (Typ.)



Temperature Rise Characteristics (Typ.)



Notice (Rating)

In operating temperatures exceeding +85°C, derating of current is necessary for this series. Please apply the derating curve shown in the chart according to the operating temperature.

Derating of Rated Current



LQM21PN_GC Series 0805 (2012) inch (mm)



| Packaging Code | Packaging | Minimum Quantity |
|----------------|---------------------|------------------|
| D | ø180mm Paper Taping | 4000 |
| B | Packing in Bulk | 1000 |

| Part Number (□: packaging code) | Inductance | Inductance Test Frequency | Rated Current | DC Resistance | S.R.F.* (min.) |
|------------------------------------|------------|---------------------------|--|---------------|----------------|
| LQM21PN1R0NGC□ | 1.0μH ±30% | 1MHz | 0.9A(Ambient temp.85°C) 0.65A(Ambient temp.125°C) | 0.10Ω±25% | 50MHz |
| LQM21PN2R2NGC□ | 2.2μH ±30% | 1MHz | 0.8A(Ambient temp.85°C) 0.6A(Ambient temp.125°C) | 0.23Ω±25% | 40MHz |

Operating temp. range: -55 to 125°C
 Class of Magnetic Shield: Ferrite Core
 *S.R.F.: Self Resonant Frequency

In operating temperatures exceeding +85°C, derating of current is necessary for the LQM21P_GC series. Please apply the derating curve shown in the chart according to the operating temperature. Please consider "Notice (Rating)." When rated current is applied to the products, the temperature rise caused by self-generated heat shall be limited to 40°C max.

Inductance-Frequency Characteristics (Typ.)



Inductance-Current Characteristics (Typ.)



Temperature Rise Characteristics (Typ.)



Notice (Rating)

In operating temperatures exceeding +85°C, derating of current is necessary for this series. Please apply the derating curve shown in the chart according to the operating temperature.

Derating of Rated Current



LQM21PN_GH Series 0805 (2012) inch (mm)



| Packaging Code | Packaging | Minimum Quantity |
|----------------|------------------------|------------------|
| L | ø180mm Embossed Taping | 3000 |
| B | Packing in Bulk | 1000 |

| Part Number (□: packaging code) | Inductance | Inductance Test Frequency | Rated Current (Isat)* | Rated Current (Itemp)* | DC Resistance | S.R.F.* (min.) |
|------------------------------------|-------------|---------------------------|--------------------------|------------------------|---------------|----------------|
| LQM21PNR47MGH□ | 0.47μH ±20% | 1MHz | 1.8A(Max) / 2.4A(Typ.) | 2.4A(Max) / 3.1A(Typ.) | 0.04Ω(typ.) | 80MHz |
| LQM21PN1R0MGH□ | 1.0μH ±20% | 1MHz | 1.1A(Max) / 1.5A(Typ.) | 1.7A(Max) / 2.0A(Typ.) | 0.08Ω(typ.) | 60MHz |
| LQM21PN1R5MGH□ | 1.5μH ±20% | 1MHz | 0.64A(Max) / 1.2A(Typ.) | 1.4A(Max) / 1.8A(Typ.) | 0.11Ω(typ.) | 50MHz |
| LQM21PN2R2MGH□ | 2.2μH ±20% | 1MHz | 0.45A(Max) / 0.7A(Typ.) | 1.3A(Max) / 1.7A(Typ.) | 0.125Ω(typ.) | 40MHz |
| LQM21PN4R7MGH□ | 4.7μH ±20% | 1MHz | 0.25A(Max) / 0.27A(Typ.) | 1.0A(Max) / 1.2A(Typ.) | 0.22Ω(typ.) | 20MHz |

Operating temp. range: -40 to 85°C

Class of Magnetic Shield: Ferrite Core

Only for reflow soldering

*Isat: Rated Current based on Inductance change

*Itemp: Rated Current based on Temperature rise

*S.R.F.: Self Resonant Frequency

When rated current is applied to the products, inductance will be within ±30% of initial inductance value range. When rated current is applied to the products, the temperature rise caused by self-generated heat shall be limited to 40°C max. Keep the temperature (ambient temperature plus self-generation of heat) under 125°C.

Inductance-Frequency Characteristics (Typ.)



Inductance-Current Characteristics (Typ.)



Temperature Rise Characteristics (Typ.)



LQM21PN_GR Series 0805 (2012) inch (mm)



| Packaging Code | Packaging | Minimum Quantity |
|----------------|---------------------|------------------|
| D | ø180mm Paper Taping | 4000 |
| B | Packing in Bulk | 1000 |

Continued on the following page. ↗

Continued from the preceding page. ↘

| Part Number (□: packaging code) | Inductance | Inductance Test Frequency | Rated Current | DC Resistance | S.R.F.* (min.) |
|------------------------------------|------------|------------------------------|--|---------------|----------------|
| LQM21PN1R0NGR□ | 1.0μH ±30% | 1MHz | 1.3A(Ambient temp.85°C) 0.95A(Ambient temp.125°C) | 0.066Ω±25% | 50MHz |
| LQM21PN3R3MGR□ | 3.3μH ±20% | 1MHz | 1.0A(Ambient temp.85°C) 0.75A(Ambient temp.125°C) | 0.150Ω±25% | 30MHz |
| LQM21PN3R3NGR□ | 3.3μH ±30% | 1MHz | 1.0A(Ambient temp.85°C) 0.75A(Ambient temp.125°C) | 0.150Ω±25% | 30MHz |
| LQM21PN4R7MGR□ | 4.7μH ±20% | 1MHz | 0.8A(Ambient temp.85°C) 0.6A(Ambient temp.125°C) | 0.23Ω±25% | 30MHz |
| LQM21PN4R7NGR□ | 4.7μH ±30% | 1MHz | 0.8A(Ambient temp.85°C) 0.6A(Ambient temp.125°C) | 0.23Ω±25% | 30MHz |

Operating temp. range: -55 to 125°C

Class of Magnetic Shield: Ferrite Core

*S.R.F.: Self Resonant Frequency

In operating temperatures exceeding +85°C, derating of current is necessary for the LQM21P_GR series. Please apply the derating curve shown in the chart according to the operating temperature. Please consider "Notice (Rating)." When rated current is applied to the products, the temperature rise caused by self-generated heat shall be limited to 40°C max.

Inductance-Frequency Characteristics (Typ.)



Inductance-Current Characteristics (Typ.)



Temperature Rise Characteristics (Typ.)



Notice (Rating)

In operating temperatures exceeding +85°C, derating of current is necessary for this series.

Please apply the derating curve shown in the chart according to the operating temperature.

Derating of Rated Current



LQM21PN_GS Series 0805 (2012) inch (mm)



| Packaging Code | Packaging | Minimum Quantity |
|----------------|---------------------|------------------|
| D | ø180mm Paper Taping | 4000 |
| B | Packing in Bulk | 1000 |

(in mm)

Continued on the following page. ↗

Continued from the preceding page. ↘

| Part Number (□: packaging code) | Inductance | Inductance Test Frequency | Rated Current | DC Resistance | S.R.F.* (min.) |
|------------------------------------|------------|------------------------------|---------------|---------------|----------------|
| LQM21PN2R2MGS□ | 2.2μH ±20% | 1MHz | 950mA | 0.180Ω±25% | 40MHz |
| LQM21PN4R7MGS□ | 4.7μH ±20% | 1MHz | 750mA | 0.290Ω±25% | 20MHz |

Operating temp. range: -40 to 85°C
 Class of Magnetic Shield: Ferrite Core
 *S.R.F.: Self Resonant Frequency

Inductance-Frequency Characteristics (Typ.)



Inductance-Current Characteristics (Typ.)



Temperature Rise Characteristics (Typ.)



LQM2MPN_DH Series 0806 (2016) inch (mm)



| Packaging Code | Packaging | Minimum Quantity |
|----------------|------------------------|------------------|
| L | ø180mm Embossed Taping | 3000 |
| B | Packing in Bulk | 1000 |

| Part Number (□: packaging code) | Inductance | Inductance Test Frequency | Rated Current (I _{sat})* | Rated Current (I _{temp})* | DC Resistance | S.R.F.* (min.) |
|------------------------------------|------------|------------------------------|------------------------------------|-------------------------------------|---------------|----------------|
| LQM2MPN2R2MDH□ | 2.2μH ±20% | 1MHz | 0.63A(Max.) / 0.68A(Typ.) | 1.27A(Max.) / 1.35A(Typ.) | 0.2Ω(typ.) | 40MHz |

Operating temp. range: -40 to 85°C
 Class of Magnetic Shield: Ferrite Core
 Only for reflow soldering
 *I_{sat}: Rated Current based on Inductance change
 *I_{temp}: Rated Current based on Temperature rise
 *S.R.F.: Self Resonant Frequency

When rated current is applied to the products, inductance will be within ±30% of initial inductance value range. When rated current is applied to the products, the temperature rise caused by self-generated heat shall be limited to 40°C max. Keep the temperature (ambient temperature plus self-generation of heat) under 125°C.

Inductance-Frequency Characteristics (Typ.)



Inductance-Current Characteristics (Typ.)



Temperature Rise Characteristics (Typ.)



LQM2MPN_EH Series 0806 (2016) inch (mm)



(in mm)

| Packaging Code | Packaging | Minimum Quantity |
|----------------|------------------------|------------------|
| L | ø180mm Embossed Taping | 3000 |
| B | Packing in Bulk | 1000 |

| Part Number (□: packaging code) | Inductance | Inductance Test Frequency | Rated Current (Isat)* | Rated Current (Itemp)* | DC Resistance | S.R.F.* (min.) |
|------------------------------------|-------------|---------------------------|-------------------------|-------------------------|---------------|----------------|
| LQM2MPNR24MEH□ | 0.24μH ±20% | 1MHz | 4.1A(Max) / 4.5A(Typ.) | 2.6A(Max) / 3.3A(Typ.) | 0.035Ω(typ.) | 130MHz |
| LQM2MPNR47MEH□ | 0.47μH ±20% | 1MHz | 2.3A(Max) / 2.5A(Typ.) | 2.15A(Max) / 2.8A(Typ.) | 0.05Ω(typ.) | 80MHz |
| LQM2MPNR68MEH□ | 0.68μH ±20% | 1MHz | 2.0A(Max) / 2.2A(Typ.) | 1.75A(Max) / 2.3A(Typ.) | 0.075Ω(typ.) | 60MHz |
| LQM2MPN1ROMEH□ | 1.0μH ±20% | 1MHz | 1.8A(Max) / 2.0A(Typ.) | 1.5A(Max) / 2.0A(Typ.) | 0.1Ω(typ.) | 50MHz |
| LQM2MPN1R5MEH□ | 1.5μH ±20% | 1MHz | 0.75A(Max) / 0.9A(Typ.) | 1.6A(Max) / 2.1A(Typ.) | 0.09Ω(typ.) | 40MHz |
| LQM2MPN2R2MEH□ | 2.2μH ±20% | 1MHz | 0.7A(Max) / 0.85A(Typ.) | 1.1A(Max) / 1.45A(Typ.) | 0.18Ω(typ.) | 30MHz |

Operating temp. range: -40 to 85°C

Class of Magnetic Shield: Ferrite Core

Only for reflow soldering

*Isat: Rated Current based on Inductance change

*Itemp: Rated Current based on Temperature rise

*S.R.F.: Self Resonant Frequency

When rated current is applied to the products, inductance will be within ±30% of initial inductance value range. When rated current is applied to the products, the temperature rise caused by self-generated heat shall be limited to 40°C max. Keep the temperature (ambient temperature plus self-generation of heat) under 125°C.

Inductance-Frequency Characteristics (Typ.)



Inductance-Current Characteristics (Typ.)



Temperature Rise Characteristics (Typ.)



LQM2MPN_GO Series 0806 (2016) inch (mm)



(in mm)

| Packaging Code | Packaging | Minimum Quantity |
|----------------|------------------------|------------------|
| L | ø180mm Embossed Taping | 3000 |
| B | Packing in Bulk | 1000 |

Continued on the following page. ↗

Continued from the preceding page. ↘

| Part Number (□: packaging code) | Inductance | Inductance Test Frequency | Rated Current | DC Resistance | S.R.F.* (min.) |
|------------------------------------|-------------|------------------------------|---|---------------|----------------|
| LQM2MPNR47MG0□ | 0.47μH ±20% | 1MHz | 1.6A(Ambient temp.85°C) 1.2A(Ambient temp.125°C) | 0.060Ω(typ.) | 100MHz |
| LQM2MPNR47NG0□ | 0.47μH ±30% | 1MHz | 1.6A(Ambient temp.85°C) 1.2A(Ambient temp.125°C) | 0.060Ω(typ.) | 100MHz |
| LQM2MPN1R0NG0□ | 1.0μH ±30% | 1MHz | 1.4A(Ambient temp.85°C) 1.0A(Ambient temp.125°C) | 0.085Ω(typ.) | 60MHz |
| LQM2MPN1R5MG0□ | 1.5μH ±20% | 1MHz | 1.2A(Ambient temp.85°C) 0.9A(Ambient temp.125°C) | 0.11Ω(typ.) | 50MHz |
| LQM2MPN1R5NG0□ | 1.5μH ±30% | 1MHz | 1.2A(Ambient temp.85°C) 0.9A(Ambient temp.125°C) | 0.11Ω(typ.) | 50MHz |
| LQM2MPN2R2MG0□ | 2.2μH ±20% | 1MHz | 1.2A(Ambient temp.85°C) 0.9A(Ambient temp.125°C) | 0.11Ω(typ.) | 40MHz |
| LQM2MPN2R2NG0□ | 2.2μH ±30% | 1MHz | 1.2A(Ambient temp.85°C) 0.9A(Ambient temp.125°C) | 0.11Ω(typ.) | 40MHz |
| LQM2MPN3R3NG0□ | 3.3μH ±30% | 1MHz | 1.2A(Ambient temp.85°C) 0.9A(Ambient temp.125°C) | 0.12Ω(typ.) | 30MHz |
| LQM2MPN4R7MG0□ | 4.7μH ±20% | 1MHz | 1.1A(Ambient temp.85°C) 0.8A(Ambient temp.125°C) | 0.14Ω(typ.) | 20MHz |
| LQM2MPN4R7NG0□ | 4.7μH ±30% | 1MHz | 1.1A(Ambient temp.85°C) 0.8A(Ambient temp.125°C) | 0.14Ω(typ.) | 20MHz |

Operating temp. range: -55 to 125°C
 Class of Magnetic Shield: Ferrite Core
 *S.R.F.: Self Resonant Frequency

In operating temperatures exceeding +85°C, derating of current is necessary for the LQM2MPN_G0 series. Please apply the derating curve shown in the chart according to the operating temperature. Please consider "Notice (Rating)." When rated current is applied to the products, the temperature rise caused by self-generated heat shall be limited to 40°C max.

Inductance-Frequency Characteristics (Typ.)



Inductance-Current Characteristics (Typ.)



Temperature Rise Characteristics (Typ.)



Notice (Rating)

In operating temperatures exceeding +85°C, derating of current is necessary for this series. Please apply the derating curve shown in the chart according to the operating temperature.

Derating of Rated Current



LQM2MPN_GH Series 0806 (2016) inch (mm)



| Packaging Code | Packaging | Minimum Quantity |
|----------------|------------------------|------------------|
| L | ø180mm Embossed Taping | 3000 |
| B | Packing in Bulk | 1000 |

| Part Number (□: packaging code) | Inductance | Inductance Test Frequency | Rated Current (Isat)* | Rated Current (Itemp)* | DC Resistance | S.R.F.* (min.) |
|------------------------------------|-------------|---------------------------|------------------------|------------------------|---------------|----------------|
| LQM2MPNR16MGH□ | 0.16μH ±20% | 1MHz | 5.0A(Max) / 5.5A(Typ.) | 4.0A(Max) / 5.0A(Typ.) | 0.014Ω(typ.) | 150MHz |
| LQM2MPNR24MGH□ | 0.24μH ±20% | 1MHz | 4.8A(Max) / 5.0A(Typ.) | 3.4A(Max) / 4.4A(Typ.) | 0.02Ω(typ.) | 130MHz |
| LQM2MPNR33MGH□ | 0.33μH ±20% | 1MHz | 3.7A(Max) / 3.9A(Typ.) | 3.1A(Max) / 4.0A(Typ.) | 0.024Ω(typ.) | 90MHz |
| LQM2MPNR47MGH□ | 0.47μH ±20% | 1MHz | 3.4A(Max) / 3.6A(Typ.) | 2.5A(Max) / 3.2A(Typ.) | 0.037Ω(typ.) | 80MHz |
| LQM2MPNR68MGH□ | 0.68μH ±20% | 1MHz | 3.1A(Max) / 3.4A(Typ.) | 1.9A(Max) / 2.5A(Typ.) | 0.055Ω(typ.) | 60MHz |
| LQM2MPN1R0MGH□ | 1.0μH ±20% | 1MHz | 2.0A(Max) / 2.3A(Typ.) | 1.9A(Max) / 2.4A(Typ.) | 0.064Ω(typ.) | 60MHz |
| LQM2MPN1R5MGH□ | 1.5μH ±20% | 1MHz | 1.8A(Max) / 2.0A(Typ.) | 1.5A(Max) / 1.9A(Typ.) | 0.104Ω(typ.) | 50MHz |
| LQM2MPN2R2MGH□ | 2.2μH ±20% | 1MHz | 1.3A(Max) / 1.5A(Typ.) | 1.0A(Max) / 1.3A(Typ.) | 0.21Ω(typ.) | 40MHz |

Operating temp. range: -40 to 85°C
 Class of Magnetic Shield: Ferrite Core
 Only for reflow soldering

*Isat: Rated Current based on Inductance change
 *Itemp: Rated Current based on Temperature rise
 *S.R.F.: Self Resonant Frequency

When rated current is applied to the products, inductance will be within ±30% of initial inductance value range. When rated current is applied to the products, the temperature rise caused by self-generated heat shall be limited to 40°C max. Keep the temperature (ambient temperature plus self-generation of heat) under 125°C.

Inductance-Frequency Characteristics (Typ.)



Inductance-Current Characteristics (Typ.)



Temperature Rise Characteristics (Typ.)



LQM2HPN_CH Series 1008 (2520) inch (mm)



| Packaging Code | Packaging | Minimum Quantity |
|----------------|------------------------|------------------|
| K | ø330mm Embossed Taping | 10000 |
| L | ø180mm Embossed Taping | 3000 |
| B | Packing in Bulk | 1000 |

Continued on the following page. ↗

Continued from the preceding page. ↘

| Part Number (□: packaging code) | Inductance | Inductance Test Frequency | Rated Current (Isat)* | Rated Current (Itemp)* | DC Resistance | S.R.F.* (min.) |
|------------------------------------|-------------|------------------------------|---------------------------|---------------------------|---------------|----------------|
| LQM2HPNR24MCH□ | 0.24μH ±20% | 1MHz | 2.55A(Max.) / 3A(Typ.) | 2.2A(Max.) / 2.7A(Typ.) | 0.055Ω(typ.) | 130MHz |
| LQM2HPNR47MCH□ | 0.47μH ±20% | 1MHz | 1.66A(Max.) / 1.95A(Typ.) | 1.5A(Max.) / 1.9A(Typ.) | 0.115Ω(typ.) | 80MHz |
| LQM2HPNR68MCH□ | 0.68μH ±20% | 1MHz | 1.1A(Max.) / 1.3A(Typ.) | 1.5A(Max.) / 1.8A(Typ.) | 0.12Ω(typ.) | 60MHz |
| LQM2HPN1R0MCH□ | 1.0μH ±20% | 1MHz | 0.6A(Max.) / 0.7A(Typ.) | 1.7A(Max.) / 2.1A(Typ.) | 0.08Ω(typ.) | 50MHz |
| LQM2HPN1R5MCH□ | 1.5μH ±20% | 1MHz | 0.6A(Max.) / 0.7A(Typ.) | 0.95A(Max.) / 1.1A(Typ.) | 0.285Ω(typ.) | 40MHz |
| LQM2HPN2R2MCH□ | 2.2μH ±20% | 1MHz | 0.43A(Max.) / 0.5A(Typ.) | 0.85A(Max.) / 1.05A(Typ.) | 0.355Ω(typ.) | 30MHz |

Operating temp. range: -40 to 85°C

Class of Magnetic Shield: Ferrite Core

Only for reflow soldering

*Isat: Rated Current based on Inductance change

*Itemp: Rated Current based on Temperature rise

*S.R.F.: Self Resonant Frequency

When rated current is applied to the products, inductance will be within ±30% of initial inductance value range. When rated current is applied to the products, the temperature rise caused by self-generated heat shall be limited to 40°C max. Keep the temperature (ambient temperature plus self-generation of heat) under 125°C.

Inductance-Frequency Characteristics (Typ.)



Inductance-Current Characteristics (Typ.)



Temperature Rise Characteristics (Typ.)



LQM2HPN_E0 Series 1008 (2520) inch (mm)



(in mm)

| Packaging Code | Packaging | Minimum Quantity |
|----------------|------------------------|------------------|
| L | ø180mm Embossed Taping | 3000 |
| B | Packing in Bulk | 1000 |

| Part Number (□: packaging code) | Inductance | Inductance Test Frequency | Rated Current | DC Resistance | S.R.F.* (min.) |
|------------------------------------|-------------|------------------------------|---------------|---------------|----------------|
| LQM2HPNR56ME0□ | 0.56μH ±20% | 1MHz | 1500mA | 0.06Ω±25% | 70MHz |

Operating temp. range: -55 to 125°C

Class of Magnetic Shield: Ferrite Core

*S.R.F.: Self Resonant Frequency

Continued on the following page. ↗

Continued from the preceding page. ↘

Inductance-Frequency Characteristics (Typ.)



Inductance-Current Characteristics (Typ.)



Temperature Rise Characteristics (Typ.)



LQM2HPN_EH Series 1008 (2520) inch (mm)



(in mm)

| Packaging Code | Packaging | Minimum Quantity |
|----------------|------------------------|------------------|
| L | ø180mm Embossed Taping | 3000 |
| B | Packing in Bulk | 1000 |

| Part Number (□: packaging code) | Inductance | Inductance Test Frequency | Rated Current (I _{sat})* | Rated Current (I _{temp})* | DC Resistance | S.R.F.* (min.) |
|------------------------------------|-------------|---------------------------|------------------------------------|-------------------------------------|---------------|----------------|
| LQM2HPNR24MEH□ | 0.24μH ±20% | 1MHz | 4.5A(Max) / 5.0A(Typ.) | 3.0A(Max) / 3.8A(Typ.) | 0.027Ω(typ.) | 130MHz |
| LQM2HPNR47MEH□ | 0.47μH ±20% | 1MHz | 4.0A(Max) / 4.3A(Typ.) | 2.2A(Max) / 2.6A(Typ.) | 0.055Ω(typ.) | 80MHz |
| LQM2HPNR68MEH□ | 0.68μH ±20% | 1MHz | 2.1A(Max) / 2.3A(Typ.) | 1.85A(Max) / 2.3A(Typ.) | 0.075Ω(typ.) | 60MHz |
| LQM2HPN1R0MEH□ | 1.0μH ±20% | 1MHz | 1.9A(Max) / 2.1A(Typ.) | 1.65A(Max) / 2.0A(Typ.) | 0.095Ω(typ.) | 50MHz |
| LQM2HPN1R5MEH□ | 1.5μH ±20% | 1MHz | 1.2A(Max) / 1.4A(Typ.) | 1.45A(Max) / 1.8A(Typ.) | 0.12Ω(typ.) | 40MHz |
| LQM2HPN2R2MEH□ | 2.2μH ±20% | 1MHz | 0.8A(Max) / 1.0A(Typ.) | 1.3A(Max) / 1.7A(Typ.) | 0.15Ω(typ.) | 30MHz |

Operating temp. range: -40 to 85°C

Class of Magnetic Shield: Ferrite Core

Only for reflow soldering

*I_{sat}: Rated Current based on Inductance change

*I_{temp}: Rated Current based on Temperature rise

*S.R.F.: Self Resonant Frequency

When rated current is applied to the products, inductance will be within ±30% of initial inductance value range. When rated current is applied to the products, the temperature rise caused by self-generated heat shall be limited to 40°C max. Keep the temperature (ambient temperature plus self-generation of heat) under 125°C.

Inductance-Frequency Characteristics (Typ.)



Inductance-Current Characteristics (Typ.)



Temperature Rise Characteristics (Typ.)



LQM2HPN_G0 Series 1008 (2520) inch (mm)



| Packaging Code | Packaging | Minimum Quantity |
|----------------|------------------------|------------------|
| L | ø180mm Embossed Taping | 3000 |
| B | Packing in Bulk | 1000 |

| Part Number (□: packaging code) | Inductance | Inductance Test Frequency | Rated Current | DC Resistance | S.R.F.* (min.) |
|------------------------------------|-------------|---------------------------|--|---------------|----------------|
| LQM2HPNR47MG0□ | 0.47μH ±20% | 1MHz | 1.8A(Ambient temp.85°C) 1.3A(Ambient temp.125°C) | 0.040Ω(typ.) | 100MHz |
| LQM2HPN1R0MG0□ | 1.0μH ±20% | 1MHz | 1.6A(Ambient temp.85°C) 1.2A(Ambient temp.125°C) | 0.055Ω(typ.) | 60MHz |
| LQM2HPN1R5MG0□ | 1.5μH ±20% | 1MHz | 1.5A(Ambient temp.85°C) 1.1A(Ambient temp.125°C) | 0.070Ω(typ.) | 50MHz |
| LQM2HPN2R2MG0□ | 2.2μH ±20% | 1MHz | 1.3A(Ambient temp.85°C) 0.97A(Ambient temp.125°C) | 0.080Ω(typ.) | 40MHz |
| LQM2HPN3R3MG0□ | 3.3μH ±20% | 1MHz | 1.2A(Ambient temp.85°C) 0.9A(Ambient temp.125°C) | 0.10Ω(typ.) | 30MHz |
| LQM2HPN4R7MG0□ | 4.7μH ±20% | 1MHz | 1.1A(Ambient temp.85°C) 0.82A(Ambient temp.125°C) | 0.11Ω(typ.) | 25MHz |

Operating temp. range: -55 to 125°C
 Class of Magnetic Shield: Ferrite Core

*S.R.F.: Self Resonant Frequency

In operating temperatures exceeding +85°C, derating of current is necessary for the LQM2HP_G0 series. Please apply the derating curve shown in the chart according to the operating temperature. Please consider "Notice (Rating)." When rated current is applied to the products, the temperature rise caused by self-generated heat shall be limited to 40°C max.

Inductance-Frequency Characteristics (Typ.)



Inductance-Current Characteristics (Typ.)



Temperature Rise Characteristics (Typ.)



Notice (Rating)

In operating temperatures exceeding +85°C, derating of current is necessary for this series. Please apply the derating curve shown in the chart according to the operating temperature.

Derating of Rated Current



LQM2HPN_GC Series 1008 (2520) inch (mm)



| Packaging Code | Packaging | Minimum Quantity |
|----------------|------------------------|------------------|
| L | ø180mm Embossed Taping | 3000 |
| B | Packing in Bulk | 1000 |

| Part Number (□: packaging code) | Inductance | Inductance Test Frequency | Rated Current | DC Resistance | S.R.F.* (min.) | Operating temp. range |
|------------------------------------|------------|---------------------------|---------------|---------------|----------------|-----------------------|
| LQM2HPN1R0MGC□ | 1.0μH ±20% | 1MHz | 1500mA | 0.08Ω±25% | 50MHz | -30 to 85°C |
| LQM2HPN3R3MGC□ | 3.3μH ±20% | 1MHz | 1000mA | 0.16Ω±25% | 30MHz | -55 to 125°C |
| LQM2HPN4R7MGC□ | 4.7μH ±20% | 1MHz | 800mA | 0.18Ω±25% | 25MHz | -55 to 125°C |

Class of Magnetic Shield: Ferrite Core
 *S.R.F.: Self Resonant Frequency

Inductance-Frequency Characteristics (Typ.)



Inductance-Current Characteristics (Typ.)



Temperature Rise Characteristics (Typ.)



LQM2HPN_GH Series 1008 (2520) inch (mm)



| Packaging Code | Packaging | Minimum Quantity |
|----------------|------------------------|------------------|
| L | ø180mm Embossed Taping | 3000 |
| B | Packing in Bulk | 1000 |

Continued on the following page. ↗

Continued from the preceding page. ↘

| Part Number (□: packaging code) | Inductance | Inductance Test Frequency | Rated Current (Isat)* | Rated Current (Itemp)* | DC Resistance | S.R.F.* (min.) |
|------------------------------------|-------------|---------------------------|------------------------|------------------------|---------------|----------------|
| LQM2HPNR24MGH□ | 0.24μH ±20% | 1MHz | 4.5A(Max) / 5.7A(Typ.) | 3.3A(Max) / 4.2A(Typ.) | 0.024Ω(typ.) | 80MHz |
| LQM2HPNR33MGH□ | 0.33μH ±20% | 1MHz | 5A(Max) / 5.3A(Typ.) | 3A(Max) / 4A(Typ.) | 0.03Ω(typ.) | 80MHz |
| LQM2HPNR47MGH□ | 0.47μH ±20% | 1MHz | 4.5A(Max) / 4.8A(Typ.) | 2.6A(Max) / 3.3A(Typ.) | 0.04Ω(typ.) | 80MHz |
| LQM2HPNR68MGH□ | 0.68μH ±20% | 1MHz | 3.8A(Max) / 4.0A(Typ.) | 2.3A(Max) / 2.9A(Typ.) | 0.05Ω(typ.) | 60MHz |
| LQM2HPN1R0MGH□ | 1.0μH ±20% | 1MHz | 2.0A(Max) / 2.3A(Typ.) | 2.3A(Max) / 2.9A(Typ.) | 0.05Ω(typ.) | 50MHz |
| LQM2HPN1R5MGH□ | 1.5μH ±20% | 1MHz | 1.5A(Max) / 1.6A(Typ.) | 2.0A(Max) / 2.6A(Typ.) | 0.065Ω(typ.) | 40MHz |
| LQM2HPN2R2MGH□ | 2.2μH ±20% | 1MHz | 1.5A(Max) / 1.6A(Typ.) | 1.5A(Max) / 1.9A(Typ.) | 0.11Ω(typ.) | 30MHz |

Operating temp. range: -40 to 85°C

Class of Magnetic Shield: Ferrite Core

Only for reflow soldering

*Isat: Rated Current based on Inductance change

*Itemp: Rated Current based on Temperature rise

*S.R.F.: Self Resonant Frequency

When rated current is applied to the products, inductance will be within ±30% of initial inductance value range. When rated current is applied to the products, the temperature rise caused by self-generated heat shall be limited to 40°C max. Keep the temperature (ambient temperature plus self-generation of heat) under 125°C.

Inductance-Frequency Characteristics (Typ.)



Inductance-Current Characteristics (Typ.)



Temperature Rise Characteristics (Typ.)



LQM2HPN_GS Series 1008 (2520) inch (mm)



(in mm)

| Packaging Code | Packaging | Minimum Quantity |
|----------------|------------------------|------------------|
| L | ø180mm Embossed Taping | 3000 |
| B | Packing in Bulk | 1000 |

| Part Number (□: packaging code) | Inductance | Inductance Test Frequency | Rated Current | DC Resistance | S.R.F.* (min.) |
|------------------------------------|------------|---------------------------|---------------|---------------|----------------|
| LQM2HPN2R2MGS□ | 2.2μH ±20% | 1MHz | 1100mA | 0.18Ω±25% | 40MHz |
| LQM2HPN3R3MGS□ | 3.3μH ±20% | 1MHz | 1050mA | 0.21Ω±25% | 20MHz |
| LQM2HPN4R7MGS□ | 4.7μH ±20% | 1MHz | 1000mA | 0.25Ω±25% | 20MHz |

Operating temp. range: -40 to 85°C

Class of Magnetic Shield: Ferrite Core

*S.R.F.: Self Resonant Frequency

Continued on the following page. ↗

Continued from the preceding page. ↘

Inductance-Frequency Characteristics (Typ.)



Inductance-Current Characteristics (Typ.)



Temperature Rise Characteristics (Typ.)



LQM2HPN_J0 Series 1008 (2520) inch (mm)



| Packaging Code | Packaging | Minimum Quantity |
|----------------|------------------------|------------------|
| L | ø180mm Embossed Taping | 3000 |
| B | Packing in Bulk | 1000 |

| Part Number (□: packaging code) | Inductance | Inductance Test Frequency | Rated Current | DC Resistance | S.R.F.* (min.) |
|------------------------------------|------------|---------------------------|---------------|---------------|----------------|
| LQM2HPN1R0MJ0□ | 1.0μH ±20% | 1MHz | 1500mA | 0.09Ω±25% | 70MHz |
| LQM2HPN2R2MJ0□ | 2.2μH ±20% | 1MHz | 1000mA | 0.12Ω±25% | 40MHz |
| LQM2HPN3R3MJ0□ | 3.3μH ±20% | 1MHz | 1000mA | 0.12Ω±25% | 30MHz |

Operating temp. range: -55 to 125°C
 Class of Magnetic Shield: Ferrite Core
 *S.R.F.: Self Resonant Frequency

Inductance-Frequency Characteristics (Typ.)



Inductance-Current Characteristics (Typ.)



Temperature Rise Characteristics (Typ.)



LQM2HPN_JH Series 1008 (2520) inch (mm)



| Packaging Code | Packaging | Minimum Quantity |
|----------------|------------------------|------------------|
| L | ø180mm Embossed Taping | 3000 |
| B | Packing in Bulk | 1000 |

(in mm)

| Part Number (□: packaging code) | Inductance | Inductance Test Frequency | Rated Current (I _{sat})* | Rated Current (I _{temp})* | DC Resistance | S.R.F.* (min.) |
|------------------------------------|-------------|---------------------------|------------------------------------|-------------------------------------|---------------|----------------|
| LQM2HPNR47MJH□ | 0.47μH ±20% | 1MHz | 3.2A(Max) / 3.5A(Typ.) | 2.7A(Max) / 3.4A(Typ.) | 0.037Ω(typ.) | 70MHz |
| LQM2HPN1R0MJH□ | 1.0μH ±20% | 1MHz | 2.1A(Max) / 2.4A(Typ.) | 2.3A(Max) / 2.9A(Typ.) | 0.05Ω(typ.) | 50MHz |
| LQM2HPN2R2MJH□ | 2.2μH ±20% | 1MHz | 1.4A(Max) / 1.6A(Typ.) | 1.5A(Max) / 1.9A(Typ.) | 0.11Ω(typ.) | 30MHz |

Operating temp. range: -40 to 85°C

Class of Magnetic Shield: Ferrite Core

Only for reflow soldering

*I_{sat}: Rated Current based on Inductance change

*I_{temp}: Rated Current based on Temperature rise

*S.R.F.: Self Resonant Frequency

When rated current is applied to the products, inductance will be within ±30% of initial inductance value. When rated current is applied to the products, the temperature rise caused by self-heating will be 40°C or less. Keep the temperature of product (ambient temperature plus self-generation of heat) under 125°C.

Inductance-Frequency Characteristics (Typ.)



Inductance-Current Characteristics (Typ.)



Temperature Rise Characteristics (Typ.)



LQM31PN_00 Series 1206 (3216) inch (mm)



(in mm)

| Packaging Code | Packaging | Minimum Quantity |
|----------------|------------------------|------------------|
| L | ø180mm Embossed Taping | 3000 |
| B | Packing in Bulk | 1000 |

Continued on the following page. ↗

Continued from the preceding page. ↘

| Part Number (□: packaging code) | Inductance | Inductance Test Frequency | Rated Current | DC Resistance | S.R.F.* (min.) |
|------------------------------------|-------------|------------------------------|---------------|---------------|----------------|
| LQM31PNR47M00□ | 0.47μH ±20% | 1MHz | 1400mA | 0.07Ω±25% | 80MHz |
| LQM31PN1R0M00□ | 1.0μH ±20% | 1MHz | 1200mA | 0.12Ω±25% | 60MHz |
| LQM31PN1R5M00□ | 1.5μH ±20% | 1MHz | 1000mA | 0.14Ω±25% | 50MHz |
| LQM31PN2R2M00□ | 2.2μH ±20% | 1MHz | 900mA | 0.19Ω±25% | 40MHz |
| LQM31PN3R3M00□ | 3.3μH ±20% | 1MHz | 800mA | 0.24Ω±25% | 30MHz |
| LQM31PN4R7M00□ | 4.7μH ±20% | 1MHz | 700mA | 0.30Ω±25% | 25MHz |

Operating temp. range: -55 to 125°C
 Class of Magnetic Shield: Ferrite Core
 *S.R.F.: Self Resonant Frequency

Inductance-Frequency Characteristics (Typ.)



Inductance-Current Characteristics (Typ.)



Temperature Rise Characteristics (Typ.)



LQM32PN_G0 Series 1210 (3225) inch (mm)



| Packaging Code | Packaging | Minimum Quantity |
|----------------|------------------------|------------------|
| L | ø180mm Embossed Taping | 3000 |
| B | Packing in Bulk | 1000 |

| Part Number (□: packaging code) | Inductance | Inductance Test Frequency | Rated Current | DC Resistance | S.R.F.* (min.) |
|------------------------------------|------------|------------------------------|---------------|---------------|----------------|
| LQM32PN1R0MG0□ | 1.0μH ±20% | 1MHz | 1800mA | 0.048Ω±25% | 40MHz |

Operating temp. range: -40 to 85°C
 Class of Magnetic Shield: Ferrite Core
 Only for reflow soldering
 *S.R.F.: Self Resonant Frequency

Inductance-Frequency Characteristics (Typ.)



Inductance-Current Characteristics (Typ.)



Temperature Rise Characteristics (Typ.)



LQM32PN_GC Series 1210 (3225) inch (mm)



(in mm)

| Packaging Code | Packaging | Minimum Quantity |
|----------------|------------------------|------------------|
| L | ø180mm Embossed Taping | 3000 |
| B | Packing in Bulk | 1000 |

| Part Number (□: packaging code) | Inductance | Inductance Test Frequency | Rated Current (Isat)* | Rated Current (Itemp)* | DC Resistance | S.R.F.* (min.) |
|------------------------------------|------------|---------------------------|-------------------------|-------------------------|---------------|----------------|
| LQM32PN1R0MGC□ | 1.0μH ±20% | 1MHz | 2.2A(Max.) / 2.9A(Typ.) | 1.8A(Max.) / 2.4A(Typ.) | 0.043Ω(Typ.) | 60MHz |

Operating temp. range: -40 to 85°C

Class of Magnetic Shield: Ferrite Core

Only for reflow soldering

*Isat: Rated Current based on Inductance change

*Itemp: Rated Current based on Temperature rise

*S.R.F.: Self Resonant Frequency

When rated current is applied to the products, inductance will be within ±30% of initial inductance value. When rated current is applied to the products, the temperature rise caused by self-heating will be 40°C or less. Keep the temperature of product (ambient temperature plus self-generation of heat) under 125°C.

Inductance-Frequency Characteristics (Typ.)



Inductance-Current Characteristics (Typ.)



Temperature Rise Characteristics (Typ.)



LQM32PN_GC

Inductors for Power Lines

Inductors for General Circuits

RF Inductors

Inductors for Power Lines ⚠️Caution/Notice

⚠️Caution

Rating

1. About the Rated Current

Do not use products beyond the rated current as this may create excessive heat and deteriorate the insulation resistance.

Be sure to provide an appropriate fail-safe function on your product to prevent a second damage that may be caused by the abnormal function or the failure of our product.

2. About Excessive Surge Current

Surge current (pulse current or rush current) greater than the specified rated current applied to the product may cause a critical failure, such as an open circuit or burnout caused by excessive temperature rise.

Please contact us in advance if applying a surge current.

Notice

Storage and Operating Condition

<Operating Environment>

Do not use products in a chemical atmosphere such as chlorine gas, acid or sulfide gas.

<Storage Requirements>

1. Storage Period

The LQB/LQG/LQH/LQP/LQW series should be used within 12 months; the other products should be used within 6 months.

Check solderability if this period is exceeded.

2. Storage Conditions

(1) Store products in a warehouse in compliance with the following conditions:

Temperature: -10 to +40°C.

Humidity: 15 to 85% (relative humidity)

Do not subject products to rapid changes in temperature and humidity.

Do not store them in a chemical atmosphere such as one containing sulfurous acid gas, alkaline gas or acid. This will prevent electrode oxidation, which causes poor solderability and possible corrosion of inductors.

(2) Do not store products in bulk packaging to prevent collision among inductors, which causes core chipping and wire breakage.

(3) Store products on pallets to protect from humidity, dust, etc.

(4) Avoid heat shock, vibration, direct sunlight, etc.

Handling

This item is designed to have sufficient strength, but handle with care to avoid chipping or breaking its ceramic structure.

LQW15D series

- To prevent breaking the wire, avoid touching with sharp materials, such as tweezers or other materials such as the bristles of a cleaning brush, to the wire wound portion.
- To prevent breaking the core, avoid applying excessive mechanical shock to products mounted on the board.
- In some mounting machines, when picking up components, a support pin pushes the components up from the bottom of the base tape. In this case, please remove the support pin. The support pin may damage the components and break the wire.
- The product temperature rises about 40°C maximum when the permissible current is applied to LQW15D. Please use caution regarding the temperature of the substrate and air around the part.

LQH_C/D/H/M/N/P series

- To prevent breaking the wire, avoid touching with sharp materials, such as tweezers or the bristles of a cleaning brush, to the wire wound portion of this product.
- To prevent breaking the core, avoid applying excessive mechanical shock to products mounted on the board.
- Temperature may rise up to max. 40°C when applying the rated current to Inductors for Power Lines. Use caution regarding the temperature rating of the circuit board and components around the products.
- Metal alloy inductor product*
Metal alloy inductor product* employs a core with low insulation resistance, pay strict attention when use it.
 - a) Do not make any through holes and copper pattern under the coil. except a copper pattern to the electrode.
 - b) Design/mount any components not to contact this product.

*Regarding Metal alloy inductor product, please refer to Product Guide in the page 2 to 5.

Continued on the following page. ↗

Inductors for Power Lines ⚠Caution/Notice

Continued from the preceding page. ↘

LQM series

- There is the possibility that magnetism may change the inductance value. Do not use a magnet or tweezers with magnetism when handling products. (The tip of the tweezers should be molded with resin or pottery.)
- When the excessive current over rated current is applied, it may cause the inductance value to change due to magnetism.

<Transportation>

Do not apply excessive vibration or mechanical shock to products.

<Resin Coating>

When coating products with resin, the relatively high resin curing stress may change inductance values.

For exterior coating, select resin carefully so that electrical and mechanical performance of the product is not affected. Prior to use, please evaluate reliability with the product mounted in your application set.

- LQW15D, LQH2HPN_DR series

An open circuit issue may occur by mechanical stress caused by the resin, amount/cured shape of resin, or operating conditions, etc. Some resins containing impurities or chloride may possibly generate chlorine by hydrolysis under some operating conditions, causing corrosion of the inductor wire and leading to an open circuit.

<Handling of a Substrate>

After mounting products on a substrate, do not apply any stress to the product caused by bending or twisting the substrate when cropping the substrate, inserting and removing a connector from the substrate, or tightening a screw to the substrate.

Excessive mechanical stress may cause cracking in the Product.

Bending



Twisting



Inductors for Power Lines Soldering and Mounting

1. Standard Land Pattern Dimensions

Land Pattern + Solder Resist
 Land Pattern
 Solder Resist
 (in mm)

| Series | Standard Land Dimensions | | | | | | |
|---|--------------------------|-------------------|--------|-----|---------|------|------|
| LQM18F/18P (Except for LQM18P_CH/FH/GH) LQM21D/21F/21P (Except for LQM21P_CA/CH/EH/GH) LQM2MP (Except for LQM2MP_EH/GH) LQM2HP (Except for LQM2HP_CH/EH/GH/JH) LQM31P LQM32P LQH2M LQH31C LQH32P LQH44P_PO/J0/GR LQH5BP LQH55D/66S LQW15CN_00 LQW15C_10 LQW15DN LQW18C | | Part Number | | a | b | c | d |
| | | LQM18F/18P | Flow | 0.7 | 2.2-2.6 | 0.7 | - |
| | | | Reflow | | | | |
| | | LQM21D/21F/21P | | 1.2 | 3.0-4.0 | 1.0 | - |
| | | LQM2MP | | 0.8 | 2.4 | 1.8 | - |
| | | LQM2HP | | 1.6 | 3.0 | 1.5 | - |
| | | LQM31P | | 2.0 | 4.2-5.2 | 1.2 | - |
| | | LQM32P | | 1.9 | 3.6 | 2.7 | - |
| | | LQH2M | | 0.8 | 2.6 | 1.0 | - |
| | | LQH31C | | 1.0 | 4.5 | 1.5 | - |
| | | LQH32P | | 1.3 | 3.8 | 2.0 | - |
| | | LQH44P_PO | | 1.3 | 4.4 | 3.0 | 1.55 |
| | | LQH44P_J0/GR | | 1.5 | 4.4 | 2.7 | 1.45 |
| | | LQH5BP | | 1.8 | 5.5 | 4.1 | 1.85 |
| | | LQH55D/66S | | 2.0 | 8.0 | 3.5 | 3.0 |
| | | LQW15CN_00 | | 0.4 | 1.4 | 0.6 | - |
| | | LQW15C_10/LQW15DN | | 0.4 | 1.4 | 0.66 | - |
| | | LQW18C | | 0.7 | 2.2 | 1.0 | - |

| Series | Part Number | Rated Current (A) | a | b | c | Land Pad Thickness and Dimension d | | | | | | |
|------------------------|-----------------------------|-------------------|---------|-----|-----|------------------------------------|-------------------|------|---------|-----|-----|-----|
| | | | | | | 18µm | 35µm | 70µm | | | | |
| | | | | | | LQM18P_CH | 0-0.7 0.7-1.05 | 0.7 | 1.8-2.0 | 0.7 | 0.7 | 0.7 |
| LQM18P_FH | 0-0.7 0.7-1.7 | 0.7 | 1.8-2.0 | 0.7 | 0.7 | 0.7 | 1.4 | 0.7 | 0.7 | | | |
| LQM18P_GH | 0-0.7 0.7-1.15 | 0.7 | 1.8-2.0 | 0.7 | 0.7 | 0.7 | 1.2 | 0.7 | 0.7 | | | |
| LQM21P_CA | 0-1.3 | 1.2 | 3.0-4.0 | 1.0 | 1.3 | 1.0 | 1.0 | 1.3 | 1.0 | 1.0 | | |
| LQM21P_CH | 0-1.0 1.0-1.5 1.5- | 1.2 | 3.0-4.0 | 1.0 | 1.0 | 1.0 | 1.5 | 1.0 | 1.0 | 2.0 | 1.5 | 1.0 |
| LQM21P_EH LQM21P_GH | 0-1.0 1.0-1.5 1.5-3.1 | 1.2 | 3.0-4.0 | 1.0 | 1.0 | 1.0 | 1.5 | 1.0 | 1.0 | 3.0 | 1.5 | 1.0 |
| LQM2MP_EH | 0-1.5 1.5-2.5 2.5-4.5 | 0.8 | 2.4 | 1.8 | 1.8 | 1.8 | 2.4 | 1.8 | 1.8 | 5.0 | 2.4 | 1.8 |
| LQM2MP_GH | 0-1.5 1.5-2.5 2.5-5.0 | 0.8 | 2.4 | 1.8 | 1.8 | 1.8 | 2.4 | 1.8 | 1.8 | 5.0 | 2.4 | 1.8 |
| LQM2HP_CH | 0-1.5 1.5-3.0 | 1.6 | 3.0 | 1.5 | 1.5 | 1.5 | 3.0 | 1.5 | 1.5 | 3.0 | 1.5 | 1.5 |
| LQM2HP_EH | 0-1.5 1.5-3.0 3.0-5.0 | 1.6 | 3.0 | 1.5 | 1.5 | 1.5 | 3.0 | 1.5 | 1.5 | 5.0 | 3.0 | 1.5 |
| LQM2HP_GH | 0-1.5 1.5-2.6 3.3-4.2 | 1.6 | 3.0 | 1.5 | 1.5 | 1.5 | 2.4 | 1.5 | 1.5 | 4.4 | 3.6 | 2.4 |
| LQM2HP_JH | 0-1.6 1.6-2.4 2.4-3.5 | 1.6 | 3.0 | 1.5 | 1.5 | 1.5 | 2.4 | 1.5 | 1.5 | 3.6 | 2.4 | 1.5 |



Attention should be paid to potential magnetic coupling effects when using the Inductor (coil) as a resonator.

Continued on the following page. ↗

Inductors for Power Lines Soldering and Mounting

Continued from the preceding page. ↘

Land Pattern + Solder Resist
 Land Pattern
 Solder Resist

 (in mm)

| Series | Standard Land Dimensions | | | | |
|---|---|-----------------|------|------|-----|
| D52LC D53LC D63LCB DEM3512C DEM3518C DEM4518C DFE18SAN_EO DFE18SAN_GO DFE18SBN_EO DFE201208S DFE201210S DFE201210U DFE201610C DFE201610E DFE201610P DFE201610R DFE201612C DFE201612E DFE201612P DFE201612R DFE252007F DFE252008C DFE252008U DFE252010C DFE252010F DFE252010P DFE252010R DFE252012C DFE252012F DFE252012P DFE252012R DFE322510C DFE322512C DFE322512F DS104C2 DS106C2 DS126C2 DS75LC FCUL0530 FDSD0412 FDSD0415 FDSD0420 FDSD0420W LQH2HP_DR LQH2HP_GR/JR LQH3NP_JR/GR/ME |  | Part Number | a | b | c |
| | | D52LC | 4.0 | 6.0 | 2.0 |
| | | D53LC | 4.0 | 6.0 | 2.0 |
| | | D63LCB | 4.6 | 6.6 | 2.6 |
| | | DEM3512C | 2.3 | 4.3 | 1.4 |
| | | DEM3518C | 2.3 | 4.3 | 1.4 |
| | | DEM4518C | 3.3 | 5.3 | 2.2 |
| | | DFE18SAN_EO | 0.7 | 1.8 | 1.0 |
| | | DFE18SAN_GO | 0.7 | 1.8 | 1.0 |
| | | DFE18SBN_EO | 0.7 | 1.8 | 1.0 |
| | | DFE201208S | 0.8 | 2.4 | 1.4 |
| | | DFE201210S | 0.8 | 2.4 | 1.4 |
| | | DFE201210U | 0.8 | 2.4 | 1.4 |
| | | DFE201610C | 0.8 | 2.4 | 1.8 |
| | | DFE201610E | 0.8 | 2.4 | 1.8 |
| | | DFE201610P | 0.8 | 2.4 | 1.8 |
| | | DFE201610R | 0.8 | 2.4 | 1.8 |
| | | DFE201612C | 0.8 | 2.4 | 1.8 |
| | | DFE201612E | 0.8 | 2.4 | 1.8 |
| | | DFE201612P | 0.8 | 2.4 | 1.8 |
| | | DFE201612R | 0.8 | 2.4 | 1.8 |
| | | DFE252007F | 1.2 | 2.8 | 2.0 |
| | | DFE252008C | 1.2 | 2.8 | 2.0 |
| | | DFE252008U | 1.2 | 2.8 | 2.0 |
| | | DFE252010C | 1.2 | 2.8 | 2.0 |
| | | DFE252010F | 1.2 | 2.8 | 2.0 |
| | | DFE252010P | 1.2 | 2.8 | 2.0 |
| | | DFE252010R | 1.2 | 2.8 | 2.0 |
| | | DFE252012C | 1.2 | 2.8 | 2.0 |
| | | DFE252012F | 1.2 | 2.8 | 2.0 |
| | | DFE252012P | 1.2 | 2.8 | 2.0 |
| | | DFE252012R | 1.2 | 2.8 | 2.0 |
| | | DFE322510C | 1.9 | 3.7 | 2.8 |
| | | DFE322512C | 1.9 | 3.7 | 2.8 |
| | | DFE322512F | 1.9 | 3.7 | 2.8 |
| | | DS104C2 | 5.4 | 10.7 | 3.6 |
| | | DS106C2 | 5.4 | 10.7 | 3.6 |
| | | DS126C2 | 7.9 | 13.1 | 3.6 |
| | | DS75LC | 4.4 | 8.4 | 3.0 |
| | | FCUL0530 | 3.4 | 7.0 | 2.0 |
| | | FDSD0412 | 1.8 | 4.6 | 2.4 |
| | | FDSD0415 | 1.8 | 4.6 | 2.4 |
| | | FDSD0420 | 1.8 | 4.6 | 2.4 |
| | | FDSD0420W | 1.8 | 4.6 | 2.4 |
| | | LQH2HP_DR | 0.83 | 2.5 | 1.6 |
| | | LQH2HP_GR/JR | 1.25 | 2.5 | 2.0 |
| | | LQH3NP_JR/GR/ME | 1.4 | 3.0 | 2.7 |

Attention should be paid to potential magnetic coupling effects when using the Inductor (coil) as a resonator.

Continued on the following page. ↗

Inductors for Power Lines

Inductors for General Circuits

RF Inductors

Inductors for Power Lines Soldering and Mounting

Continued from the preceding page. ↘

Land Pattern + Solder Resist
 Land Pattern
 Solder Resist
 (in mm)

| Series | Standard Land Dimensions | | | | | | | | | | | | | | | | | | | | | | | | | | | | | | | | | | | | | | | | | | | | | | | | | | | | | | | | | | | | | | | | | | | | | | | | | | | | | | | | | | | | | | | | | | | | | | | | | | | | | | | | | | |
|--|---|---|-----|---|-----|-----|--|--|-------------|---|---|----------|-----|-----|-----|----------|-----|-----|-----|----------|-----|-----|---------|----------|-----|-----|-----|----------|-----|-----|-----|----------|-----|-----|-----|----------|-----|-----|-----|----------|-----|-----|-----|----------|-----|-----|-----|----------|-----|-----|-----|----------|-----|-----|-----|----------|-----|-----|-----|----------|-----|-----|-----|----------|-----|-----|--------------------------|-----------|-----|-----|-----|----------|-----|-----|-----|----------|-----|-----|-----|---------|-----|-----|-----|----------|-----|-----|-----|---------|-----|-----|-----|---------|-----|-----|-----|----------|-----|-----|-----|----------|-----|-----|-----|----------|-----|-----|-----|
| DEM2812C DEM2815C DEM2818C FCUL0624 FCUL0630 FCUL1040 FCUL1060 FDSD0512 FDSD0515 FDSD0518 FDSD0630 FDUE0630 FDUE0640 FDUE0650 FDUE1040D FDUE1245 FDUE1260 FDV0530 FDV0530S FDV0618 FDV0620 FDVE0630 FDVE0640 FDVE1040 |  | | | | | | <table border="1" style="width: 100%; border-collapse: collapse;"> <thead> <tr> <th style="background-color: #cccccc;">Part Number</th> <th style="background-color: #cccccc;">a</th> <th style="background-color: #cccccc;">b</th> <th style="background-color: #cccccc;">c</th> </tr> </thead> <tbody> <tr><td>DEM2812C</td><td>1.8</td><td>0.9</td><td>1.2</td></tr> <tr><td>DEM2815C</td><td>1.8</td><td>0.9</td><td>1.2</td></tr> <tr><td>DEM2818C</td><td>1.8</td><td>0.9</td><td>1.2</td></tr> <tr><td>FCUL0624</td><td>4.0</td><td>2.1</td><td>1.9</td></tr> <tr><td>FCUL0630</td><td>4.0</td><td>2.1</td><td>1.9</td></tr> <tr><td>FCUL1040</td><td>6.0</td><td>3.8</td><td>4.9</td></tr> <tr><td>FCUL1060</td><td>6.0</td><td>3.8</td><td>4.9</td></tr> <tr><td>FDSD0512</td><td>2.2</td><td>1.7</td><td>2.8</td></tr> <tr><td>FDSD0515</td><td>2.2</td><td>1.7</td><td>2.8</td></tr> <tr><td>FDSD0518</td><td>2.2</td><td>1.7</td><td>2.8</td></tr> <tr><td>FDSD0630</td><td>4.0</td><td>2.0</td><td>3.5</td></tr> <tr><td>FDUE0630</td><td>4.0</td><td>2.1</td><td>2.5</td></tr> <tr><td>FDUE0640</td><td>4.0</td><td>2.1</td><td>2.5</td></tr> <tr><td>FDUE0650</td><td>4.0</td><td>2.1</td><td>3.2: 0.6μH 2.9: 1.0μH</td></tr> <tr><td>FDUE1040D</td><td>6.0</td><td>3.8</td><td>4.6</td></tr> <tr><td>FDUE1245</td><td>8.0</td><td>3.0</td><td>3.6</td></tr> <tr><td>FDUE1260</td><td>6.5</td><td>4.6</td><td>4.0</td></tr> <tr><td>FDV0530</td><td>3.2</td><td>1.8</td><td>3.1</td></tr> <tr><td>FDV0530S</td><td>2.2</td><td>1.7</td><td>2.8</td></tr> <tr><td>FDV0618</td><td>4.0</td><td>2.0</td><td>3.5</td></tr> <tr><td>FDV0620</td><td>4.0</td><td>2.0</td><td>3.5</td></tr> <tr><td>FDVE0630</td><td>4.0</td><td>2.0</td><td>3.5</td></tr> <tr><td>FDVE0640</td><td>4.0</td><td>2.0</td><td>3.5</td></tr> <tr><td>FDVE1040</td><td>6.0</td><td>3.8</td><td>4.0</td></tr> </tbody> </table> | Part Number | a | b | c | DEM2812C | 1.8 | 0.9 | 1.2 | DEM2815C | 1.8 | 0.9 | 1.2 | DEM2818C | 1.8 | 0.9 | 1.2 | FCUL0624 | 4.0 | 2.1 | 1.9 | FCUL0630 | 4.0 | 2.1 | 1.9 | FCUL1040 | 6.0 | 3.8 | 4.9 | FCUL1060 | 6.0 | 3.8 | 4.9 | FDSD0512 | 2.2 | 1.7 | 2.8 | FDSD0515 | 2.2 | 1.7 | 2.8 | FDSD0518 | 2.2 | 1.7 | 2.8 | FDSD0630 | 4.0 | 2.0 | 3.5 | FDUE0630 | 4.0 | 2.1 | 2.5 | FDUE0640 | 4.0 | 2.1 | 2.5 | FDUE0650 | 4.0 | 2.1 | 3.2: 0.6μH 2.9: 1.0μH | FDUE1040D | 6.0 | 3.8 | 4.6 | FDUE1245 | 8.0 | 3.0 | 3.6 | FDUE1260 | 6.5 | 4.6 | 4.0 | FDV0530 | 3.2 | 1.8 | 3.1 | FDV0530S | 2.2 | 1.7 | 2.8 | FDV0618 | 4.0 | 2.0 | 3.5 | FDV0620 | 4.0 | 2.0 | 3.5 | FDVE0630 | 4.0 | 2.0 | 3.5 | FDVE0640 | 4.0 | 2.0 | 3.5 | FDVE1040 | 6.0 | 3.8 | 4.0 |
| | Part Number | a | b | c | | | | | | | | | | | | | | | | | | | | | | | | | | | | | | | | | | | | | | | | | | | | | | | | | | | | | | | | | | | | | | | | | | | | | | | | | | | | | | | | | | | | | | | | | | | | | | | | | | | | | | | |
| | DEM2812C | 1.8 | 0.9 | 1.2 | | | | | | | | | | | | | | | | | | | | | | | | | | | | | | | | | | | | | | | | | | | | | | | | | | | | | | | | | | | | | | | | | | | | | | | | | | | | | | | | | | | | | | | | | | | | | | | | | | | | | | | |
| | DEM2815C | 1.8 | 0.9 | 1.2 | | | | | | | | | | | | | | | | | | | | | | | | | | | | | | | | | | | | | | | | | | | | | | | | | | | | | | | | | | | | | | | | | | | | | | | | | | | | | | | | | | | | | | | | | | | | | | | | | | | | | | | |
| | DEM2818C | 1.8 | 0.9 | 1.2 | | | | | | | | | | | | | | | | | | | | | | | | | | | | | | | | | | | | | | | | | | | | | | | | | | | | | | | | | | | | | | | | | | | | | | | | | | | | | | | | | | | | | | | | | | | | | | | | | | | | | | | |
| | FCUL0624 | 4.0 | 2.1 | 1.9 | | | | | | | | | | | | | | | | | | | | | | | | | | | | | | | | | | | | | | | | | | | | | | | | | | | | | | | | | | | | | | | | | | | | | | | | | | | | | | | | | | | | | | | | | | | | | | | | | | | | | | | |
| | FCUL0630 | 4.0 | 2.1 | 1.9 | | | | | | | | | | | | | | | | | | | | | | | | | | | | | | | | | | | | | | | | | | | | | | | | | | | | | | | | | | | | | | | | | | | | | | | | | | | | | | | | | | | | | | | | | | | | | | | | | | | | | | | |
| | FCUL1040 | 6.0 | 3.8 | 4.9 | | | | | | | | | | | | | | | | | | | | | | | | | | | | | | | | | | | | | | | | | | | | | | | | | | | | | | | | | | | | | | | | | | | | | | | | | | | | | | | | | | | | | | | | | | | | | | | | | | | | | | | |
| | FCUL1060 | 6.0 | 3.8 | 4.9 | | | | | | | | | | | | | | | | | | | | | | | | | | | | | | | | | | | | | | | | | | | | | | | | | | | | | | | | | | | | | | | | | | | | | | | | | | | | | | | | | | | | | | | | | | | | | | | | | | | | | | | |
| | FDSD0512 | 2.2 | 1.7 | 2.8 | | | | | | | | | | | | | | | | | | | | | | | | | | | | | | | | | | | | | | | | | | | | | | | | | | | | | | | | | | | | | | | | | | | | | | | | | | | | | | | | | | | | | | | | | | | | | | | | | | | | | | | |
| | FDSD0515 | 2.2 | 1.7 | 2.8 | | | | | | | | | | | | | | | | | | | | | | | | | | | | | | | | | | | | | | | | | | | | | | | | | | | | | | | | | | | | | | | | | | | | | | | | | | | | | | | | | | | | | | | | | | | | | | | | | | | | | | | |
| | FDSD0518 | 2.2 | 1.7 | 2.8 | | | | | | | | | | | | | | | | | | | | | | | | | | | | | | | | | | | | | | | | | | | | | | | | | | | | | | | | | | | | | | | | | | | | | | | | | | | | | | | | | | | | | | | | | | | | | | | | | | | | | | | |
| | FDSD0630 | 4.0 | 2.0 | 3.5 | | | | | | | | | | | | | | | | | | | | | | | | | | | | | | | | | | | | | | | | | | | | | | | | | | | | | | | | | | | | | | | | | | | | | | | | | | | | | | | | | | | | | | | | | | | | | | | | | | | | | | | |
| | FDUE0630 | 4.0 | 2.1 | 2.5 | | | | | | | | | | | | | | | | | | | | | | | | | | | | | | | | | | | | | | | | | | | | | | | | | | | | | | | | | | | | | | | | | | | | | | | | | | | | | | | | | | | | | | | | | | | | | | | | | | | | | | | |
| | FDUE0640 | 4.0 | 2.1 | 2.5 | | | | | | | | | | | | | | | | | | | | | | | | | | | | | | | | | | | | | | | | | | | | | | | | | | | | | | | | | | | | | | | | | | | | | | | | | | | | | | | | | | | | | | | | | | | | | | | | | | | | | | | |
| | FDUE0650 | 4.0 | 2.1 | 3.2: 0.6μH 2.9: 1.0μH | | | | | | | | | | | | | | | | | | | | | | | | | | | | | | | | | | | | | | | | | | | | | | | | | | | | | | | | | | | | | | | | | | | | | | | | | | | | | | | | | | | | | | | | | | | | | | | | | | | | | | | |
| | FDUE1040D | 6.0 | 3.8 | 4.6 | | | | | | | | | | | | | | | | | | | | | | | | | | | | | | | | | | | | | | | | | | | | | | | | | | | | | | | | | | | | | | | | | | | | | | | | | | | | | | | | | | | | | | | | | | | | | | | | | | | | | | | |
| | FDUE1245 | 8.0 | 3.0 | 3.6 | | | | | | | | | | | | | | | | | | | | | | | | | | | | | | | | | | | | | | | | | | | | | | | | | | | | | | | | | | | | | | | | | | | | | | | | | | | | | | | | | | | | | | | | | | | | | | | | | | | | | | | |
| | FDUE1260 | 6.5 | 4.6 | 4.0 | | | | | | | | | | | | | | | | | | | | | | | | | | | | | | | | | | | | | | | | | | | | | | | | | | | | | | | | | | | | | | | | | | | | | | | | | | | | | | | | | | | | | | | | | | | | | | | | | | | | | | | |
| | FDV0530 | 3.2 | 1.8 | 3.1 | | | | | | | | | | | | | | | | | | | | | | | | | | | | | | | | | | | | | | | | | | | | | | | | | | | | | | | | | | | | | | | | | | | | | | | | | | | | | | | | | | | | | | | | | | | | | | | | | | | | | | | |
| | FDV0530S | 2.2 | 1.7 | 2.8 | | | | | | | | | | | | | | | | | | | | | | | | | | | | | | | | | | | | | | | | | | | | | | | | | | | | | | | | | | | | | | | | | | | | | | | | | | | | | | | | | | | | | | | | | | | | | | | | | | | | | | | |
| | FDV0618 | 4.0 | 2.0 | 3.5 | | | | | | | | | | | | | | | | | | | | | | | | | | | | | | | | | | | | | | | | | | | | | | | | | | | | | | | | | | | | | | | | | | | | | | | | | | | | | | | | | | | | | | | | | | | | | | | | | | | | | | | |
| | FDV0620 | 4.0 | 2.0 | 3.5 | | | | | | | | | | | | | | | | | | | | | | | | | | | | | | | | | | | | | | | | | | | | | | | | | | | | | | | | | | | | | | | | | | | | | | | | | | | | | | | | | | | | | | | | | | | | | | | | | | | | | | | |
| | FDVE0630 | 4.0 | 2.0 | 3.5 | | | | | | | | | | | | | | | | | | | | | | | | | | | | | | | | | | | | | | | | | | | | | | | | | | | | | | | | | | | | | | | | | | | | | | | | | | | | | | | | | | | | | | | | | | | | | | | | | | | | | | | |
| | FDVE0640 | 4.0 | 2.0 | 3.5 | | | | | | | | | | | | | | | | | | | | | | | | | | | | | | | | | | | | | | | | | | | | | | | | | | | | | | | | | | | | | | | | | | | | | | | | | | | | | | | | | | | | | | | | | | | | | | | | | | | | | | | |
| | FDVE1040 | 6.0 | 3.8 | 4.0 | | | | | | | | | | | | | | | | | | | | | | | | | | | | | | | | | | | | | | | | | | | | | | | | | | | | | | | | | | | | | | | | | | | | | | | | | | | | | | | | | | | | | | | | | | | | | | | | | | | | | | | |
| | FDA1055 FDA1254 |  | | | | | | <table border="1" style="width: 100%; border-collapse: collapse;"> <thead> <tr> <th style="background-color: #cccccc;">Part Number</th> <th style="background-color: #cccccc;">a</th> <th style="background-color: #cccccc;">b</th> <th style="background-color: #cccccc;">c</th> <th style="background-color: #cccccc;">d</th> <th style="background-color: #cccccc;">e</th> <th style="background-color: #cccccc;">f</th> </tr> </thead> <tbody> <tr><td>FDA1055</td><td>4.3</td><td>2.0</td><td>2.9</td><td>3.0</td><td>7.7</td><td>2.4</td></tr> <tr><td>FDA1254</td><td>5.0</td><td>2.5</td><td>2.9</td><td>3.0</td><td>9.7</td><td>2.4</td></tr> </tbody> </table> | Part Number | a | b | c | d | e | f | FDA1055 | 4.3 | 2.0 | 2.9 | 3.0 | 7.7 | 2.4 | FDA1254 | 5.0 | 2.5 | 2.9 | 3.0 | 9.7 | 2.4 | | | | | | | | | | | | | | | | | | | | | | | | | | | | | | | | | | | | | | | | | | | | | | | | | | | | | | | | | | | | | | | | | | | | | | | | | | | | | | |
| | | Part Number | a | b | c | d | e | f | | | | | | | | | | | | | | | | | | | | | | | | | | | | | | | | | | | | | | | | | | | | | | | | | | | | | | | | | | | | | | | | | | | | | | | | | | | | | | | | | | | | | | | | | | | | | | | | | | | |
| | FDA1055 | 4.3 | 2.0 | 2.9 | 3.0 | 7.7 | 2.4 | | | | | | | | | | | | | | | | | | | | | | | | | | | | | | | | | | | | | | | | | | | | | | | | | | | | | | | | | | | | | | | | | | | | | | | | | | | | | | | | | | | | | | | | | | | | | | | | | | | | |
| | FDA1254 | 5.0 | 2.5 | 2.9 | 3.0 | 9.7 | 2.4 | | | | | | | | | | | | | | | | | | | | | | | | | | | | | | | | | | | | | | | | | | | | | | | | | | | | | | | | | | | | | | | | | | | | | | | | | | | | | | | | | | | | | | | | | | | | | | | | | | | | |
| LQH32C/D | Reflow Soldering *  | | | Flow Soldering (except LQH32D)  | | | | | | | | | | | | | | | | | | | | | | | | | | | | | | | | | | | | | | | | | | | | | | | | | | | | | | | | | | | | | | | | | | | | | | | | | | | | | | | | | | | | | | | | | | | | | | | | | | | | | | | |
| LQH3NP_MR |  | | | | | | | | | | | | | | | | | | | | | | | | | | | | | | | | | | | | | | | | | | | | | | | | | | | | | | | | | | | | | | | | | | | | | | | | | | | | | | | | | | | | | | | | | | | | | | | | | | | | | | | | | | |

Attention should be paid to potential magnetic coupling effects when using the Inductor (coil) as a resonator.

Continued on the following page. ↗

Inductors for Power Lines Soldering and Mounting

Continued from the preceding page. ↘

■ Land Pattern + Solder Resist ■ Land Pattern □ Solder Resist
 (in mm)

| Series | Standard Land Dimensions | |
|-------------------------------|---|--|
| LQH43CN LQH43PN LQH43PB | <p>Reflow Soldering *</p> | <p>Flow Soldering (except LQH43PB)</p> |
| | *Applicable to flow soldering. (except LQH43PB) | |

Attention should be paid to potential magnetic coupling effects when using the Inductor (coil) as a resonator.

| Series | Standard Land Dimensions | Series | Standard Land Dimensions |
|---------------------------|--------------------------|-------------------------------|--------------------------|
| DEM10050C DEM10050C_DD | | DG6028C DG6045C DG6050C | |
| DEM8030C | | DG8040C | |
| DEM8040C DEM8045C | | | |

Attention should be paid to potential magnetic coupling effects when using the Inductor (coil) as a resonator.

2. Standard Soldering Conditions

(1) Soldering method

Apply reflow soldering process except for flow soldering available products.

Please contact Murata regarding other soldering methods.

Solder: Use Sn-3.0Ag-0.5Cu solder.

Flux: Use rosin-based flux, but not strongly acidic flux (with chlorine content exceeding 0.2wt%).

Do not use water-soluble flux.

Please pay attention to solder paste's penetrating in order to avoid short circuit between the lines.

For additional mounting methods, please contact Murata.

Continued on the following page. ↗

Inductors for Power Lines Soldering and Mounting

Continued from the preceding page. ↘

(2) Soldering profile

● Flow Soldering profile



| Series | Pre-heating | | Standard Profile | | | Limit Profile | | |
|---|-------------|------------|------------------|------------|---------------|---------------|------------|---------------|
| | Temp. (T1) | Time. (t1) | Temp. (T2) | Time. (t2) | Cycle of flow | Temp. (T3) | Time. (t2) | Cycle of flow |
| LQM18F/18P (Except for CH/DH/FH/GH) LQM21D/21F/21P (Except for CA/CH/EH/GH) LQM2MP (Except for DH/EH/GH) LQM2HP (Except for CH/EH/GH/JH) LQM31P LQH31C | 150°C | 60s min. | 250°C | 4 to 6s | 2 times max. | 265±3°C | 5s max. | 2 times max. |
| LQH32C LQH43C/43PN | 150°C | 60s min. | 250°C | 4 to 6s | 2 times max. | 265±3°C | 5s max. | 1 time |

● Reflow Soldering profile



| Series | Standard Profile | | | | Limit Profile | | | |
|--|------------------|------------|-----------------------|-----------------|---------------|------------|-----------------------|-----------------|
| | Temp. (T1) | Time. (t1) | Peak temperature (T2) | Cycle of reflow | Temp. (T3) | Time. (t2) | Peak temperature (T4) | Cycle of reflow |
| LQM18F/18P LQM21D/21F/21P/2MP/2HP LQM31P/32P LQH2M, LQH2HP LQH31C LQH32D_23 (Except for 391/471/561) LQH32D_53 LQH3NP/32P/43P/44P/5BP LQW15C/18C/15D | 220°C | 30 to 60s | 245±3°C | 2 times max. | 230°C | 60s max. | 260°C/10s | 2 times max. |
| LQH32C LQH32D_23 (391/471/561 only) LQH43C LQH55D, LQH66S | 220°C | 30 to 60s | 245±3°C | 2 times max. | 230°C | 60s max. | 260°C/10s | 1 time |

Continued on the following page. ↗

Inductors for Power Lines Soldering and Mounting

Continued from the preceding page. ↘

●Reflow Soldering



*Reflow Times: 2 times max.

*We recommend an infrared ray as the heat source of the reflow bath. However halogen lamp should not be used; the side heat would be beyond the range of resistance heat, so we do not recommend it.

| Series | Heating | | Peak Temperature | Cycle of Flow |
|--------------|---------|-----------|------------------|---------------|
| | Temp. | Time | | |
| D52LC | 230°C | 20 to 40s | 250+5/-0°C | 2 times max. |
| D53LC | | | | |
| D63LCB | | | | |
| DEM10050C | | | | |
| DEM10050C_DD | | | | |
| DEM2812C | | | | |
| DEM2815C | | | | |
| DEM2818C | | | | |
| DEM3512C | | | | |
| DEM3518C | | | | |
| DEM4518C | | | | |
| DEM8030C | | | | |
| DEM8040C | | | | |
| DEM8045C | | | | |
| DFE18SAN_EO | | | | |
| DFE18SAN_GO | | | | |
| DFE18SBN_EO | | | | |
| DFE201208S | | | | |
| DFE201210S | | | | |
| DFE201210U | | | | |
| DFE201610C | | | | |
| DFE201610E | | | | |
| DFE201610P | | | | |
| DFE201610R | | | | |
| DFE201612C | | | | |
| DFE201612E | | | | |
| DFE201612P | | | | |
| DFE201612R | | | | |
| DFE252007F | | | | |
| DFE252008C | | | | |
| DFE252008U | | | | |
| DFE252010C | | | | |
| DFE252010F | | | | |
| DFE252010P | | | | |
| DFE252010R | | | | |
| DFE252012C | | | | |
| DFE252012F | | | | |
| DFE252012P | | | | |
| DFE252012R | | | | |
| DFE322510C | | | | |
| DFE322512C | | | | |
| DFE322512F | | | | |

| Series | Heating | | Peak Temperature | Cycle of Flow |
|-----------|---------|-----------|------------------|---------------|
| | Temp. | Time | | |
| DG6028C | 230°C | 20 to 40s | 250+5/-0°C | 2 times max. |
| DG6045C | | | | |
| DG6050C | | | | |
| DG8040C | | | | |
| DS104C2 | | | | |
| DS106C2 | | | | |
| DS126C2 | | | | |
| DS75LC | | | | |
| FCUL0530 | | | | |
| FCUL0624 | | | | |
| FCUL0630 | | | | |
| FCUL1040 | | | | |
| FCUL1060 | | | | |
| FDA1055 | | | | |
| FDA1254 | | | | |
| FSD0412 | | | | |
| FSD0415 | | | | |
| FSD0420 | | | | |
| FSD0420W | | | | |
| FSD0512 | | | | |
| FSD0515 | | | | |
| FSD0518 | | | | |
| FSD0630 | | | | |
| FDUE0630 | | | | |
| FDUE0640 | | | | |
| FDUE0650 | | | | |
| FDUE1040D | | | | |
| FDUE1245 | | | | |
| FDUE1260 | | | | |
| FDV0530 | | | | |
| FDV0530S | | | | |
| FDV0618 | | | | |
| FDV0620 | | | | |
| FDVE0630 | | | | |
| FDVE0640 | | | | |
| FDVE1040 | | | | |

Continued on the following page. ↗

Inductors for Power Lines Soldering and Mounting

Continued from the preceding page. ↘

(3) Reworking with a Soldering Iron

Preheating at 150°C for 1 minute is required. Do not directly touch the ceramic element with the tip of the soldering iron. The reworking soldering conditions are as follows:

- Soldering iron power output: 80W max.
- Temperature of soldering iron tip: 350°C
- Diameter of soldering iron end: 3.0mm max.
- Soldering time: within 3 s

Please keep the fix time with the soldering iron within 1 time for each terminal.

3. Mounting Instructions

(1) Land Pattern Designing (LQH series, LQW series, DFE18SAN/SBN series)

Please follow the recommended patterns. Otherwise, their performance, which includes electrical performance or solderability, may be affected, or result in "position shift" in the soldering process.

(2) Magnetic Coupling

Since some products are constructed like an open magnetic circuit, narrow spacing between inductors (coils) may cause magnetic coupling.



(3) PCB Warping

The PCB should be designed so that products are not subjected to mechanical stress caused by warping the board.



Continued on the following page. ↗

Inductors for Power Lines Soldering and Mounting

Continued from the preceding page. ↘

(4) Amount of Solder Paste

Excessive solder causes electrode corrosion, while insufficient solder causes low electrode bonding strength. Adjust the amount of solder paste as shown on the right so that the correct amount is applied.

Guideline of solder paste thickness

- LQW15D: 50 to 100μm
- LQM, LQH2M/2HP, LQH3NP/32P, LQH43PB/44P/5BP, DFE18SAN/SBN: 100 to 150μm
- LQH31C/32C, LQH43C/43PN, LQH55D, LQH66S: 200 to 300μm



4. Cleaning

Beware of function well before use the product when washing. The following conditions should be observed when cleaning LQ series:

- (1) Cleaning Temperature: 60°C max. (40°C max. for alcohol cleaning agents)
- (2) Ultrasonic
 - Output: 20W/l max.
 - Duration: 5 minutes max.
 - Frequency: 28 to 40kHz
 - Care should be taken not to cause resonance of the PCB and mounted products.

(3) Cleaning agent

The following cleaning agents have been tested on individual components. Evaluation in complete assembly should be done prior to production.

- (a) Alcohol cleaning agents
 - Isopropyl alcohol (IPA)
- (b) Aqueous cleaning agents
 - Pine Alpha ST-100S
 - LQH66S series: Aqueous agents should not be used because they may cause quality deterioration or damage to appearance.

- (4) Ensure that flux residue is completely removed. Component should be thoroughly dried after aqueous agents have been removed with deionized water.

Inductors for Power Lines Packaging

Minimum Quantity and 8mm Width Taping Dimensions



Paper Tape

| Part Number | Dimensions | | Total Thickness of Tape c | Packaging Code (Minimum Qty. (pcs.)) | | |
|-------------|------------|------|------------------------------|--------------------------------------|-------------|---------|
| | a | b | | ø180mm reel | ø330mm reel | Bulk |
| LQW15D | 0.8 | 1.29 | 1.2 max. | D (8000) | — | B (500) |

(in mm)

Minimum Quantity and 8mm Width Taping Dimensions



The dimension of the cavity of embossed tape is measured at the bottom side.

*1: 0.25 LQM2HP/2MP/31P_00, LQH2, LQM21P

Paper Tape 1

| Part Number | Dimensions | | Total Thickness of Tape c | Packaging Code (Minimum Qty. (pcs.)) | | |
|---------------------|------------|------|------------------------------|--------------------------------------|-------------|----------|
| | a | b | | ø180mm reel | ø330mm reel | Bulk |
| LQM21D (1 to 10μH) | 1.45 | 2.25 | 1.1 max. | D (4000) | J (10000) | B (1000) |
| LQM21F (1 to 2.2μH) | 1.45 | 2.25 | 1.1 max. | D (4000) | J (10000) | B (1000) |
| LQM21P_C0 | 1.45 | 2.25 | 0.8 max. | D (4000) | — | B (1000) |
| LQM21P_CA | 1.45 | 1.45 | 0.9 max. | D (3000) | — | B (1000) |
| LQM21P_CH | 1.45 | 2.25 | 0.7 max. | D (3000) | J (10000) | B (1000) |
| LQM21P_EH | 1.45 | 2.25 | 1.0 max. | D (3000) | — | B (1000) |
| LQM21P_G | 1.45 | 2.25 | 1.1 max. | D (4000) | — | B (1000) |
| LQM18F | 1.05 | 1.85 | 1.1 max. | D (4000) | J (10000) | B (1000) |
| LQM18P_D0 | 1.05 | 1.85 | 0.85 max. | D (4000) | — | B (1000) |
| LQM18P_CH | 1.1 | 1.9 | 0.95 max. | D (4000) | — | B (1000) |
| LQM18P_GH | 1.1 | 1.9 | 1.25 max. | D (4000) | — | B (1000) |

Paper Tape 2

| Part Number | Dimensions | | Total Thickness of Tape c | Packaging Code (Minimum Qty. (pcs.)) | | |
|-------------|------------|------|------------------------------|--------------------------------------|-------------|----------|
| | a | b | | ø180mm reel | ø330mm reel | Bulk |
| LQM18PN_DH | 1.05 | 1.85 | 1.05 max. | D (4000) | — | B (1000) |

(in mm)

Continued on the following page. ↗

Inductors for Power Lines Packaging

Continued from the preceding page. ↘

Minimum Quantity and 8mm Width Taping Dimensions

| Embossed Tape | | | | | | |
|---------------------------|------------|------|-----------------|--------------------------------------|-------------|----------|
| Part Number | Dimensions | | Depth of Cavity | Packaging Code (Minimum Qty. (pcs.)) | | |
| | a | b | c | ø180mm reel | ø330mm reel | Bulk |
| LQH2HP_DR | 2.3 | 2.8 | 0.7 | L (4000) | — | — |
| LQH2MC_02 | 1.9 | 2.3 | 1.05 | L (3000) | — | B (100) |
| LQH2MC_52 | 1.9 | 2.3 | 0.8 | L (3000) | — | B (100) |
| LQH2MP | 1.9 | 2.3 | 1.05 | L (3000) | — | — |
| LQH31C | 1.9 | 3.6 | 2.0 | L (2000) | K (7500) | — |
| LQH32C_33/23, LQH32D_23 | 2.9 | 3.6 | 2.1 | L (2000) | K (7500) | — |
| LQH32C_53, LQH32D_53 | 2.9 | 3.6 | 1.7 | L (2000) | K (7500) | — |
| LQH32PN_NC | 2.9 | 3.6 | 1.7 | L (2000) | K (7500) | — |
| LQH32PB_N0/NC, LQH32PN_N0 | 2.9 | 3.6 | 1.7 | L (2000) | K (7500) | B (500) |
| LQM18P_B0 | 1.0 | 1.8 | 0.50 | L (4000) | — | B (1000) |
| LQM18P_C0 | 1.0 | 1.8 | 0.60 | L (4000) | — | B (1000) |
| LQM18P_F0 | 1.0 | 1.8 | 1.0 | L (4000) | — | B (1000) |
| LQM21D (22 to 47μH) | 1.45 | 2.25 | 1.3 | L (3000) | K (10000) | B (1000) |
| LQM21F (4.7 to 47μH) | 1.45 | 2.25 | 1.3 | L (3000) | K (10000) | B (1000) |
| LQM21P_GH | 1.45 | 2.25 | 1.05 | L (3000) | — | B (1000) |
| LQM2HP_CH | 2.3 | 2.8 | 0.6 | L (3000) | K (10000) | B (1000) |
| LQM2HP_E0/EH | 2.3 | 2.8 | 0.9 | L (3000) | — | B (1000) |
| LQM2HP_G0/GC/GS | 2.3 | 2.8 | 1.1 | L (3000) | — | B (1000) |
| LQM2HP_GH | 2.3 | 2.8 | 1.1 | L (3000) | — | — |
| LQM2HP_J0/JC | 2.25 | 2.75 | 1.3 | L (3000) | — | B (1000) |
| LQM2HP_JH | 2.25 | 2.75 | 1.3 | L (3000) | — | — |
| LQM2MP_DH/EH | 1.9 | 2.4 | 0.9 | L (3000) | — | B (1000) |
| LQM2MP_G0 | 1.85 | 2.25 | 1.1 | L (3000) | — | B (1000) |
| LQM2MP_GH | 1.9 | 2.4 | 1.1 | L (3000) | — | — |
| LQM31P_00 | 1.9 | 3.5 | 1.05 | L (3000) | — | B (1000) |
| LQM32P_G0/GC | 2.9 | 3.6 | 1.15 | L (3000) | — | B (1000) |

(in mm)

Continued on the following page. ↗

Inductors for Power Lines Packaging

Continued from the preceding page. ↘

Minimum Quantity and 8mm Width Taping Dimensions



The dimension of the cavity is measured at the bottom side.

Embossed Tape

| Part Number | Dimensions | | Depth of Cavity | Packaging Code (Minimum Qty. (pcs.)) | | |
|-------------|------------|-----|-----------------|--------------------------------------|--------------------|------|
| | a | b | | $\phi 180$ mm reel | $\phi 330$ mm reel | Bulk |
| LQH2HP_GR | 2.3 | 2.8 | 1.1 | L (3000) | — | — |
| LQH2HP_JR | 2.3 | 2.8 | 1.3 | L (2000) | — | — |



The dimension of the cavity is measured at the bottom side.

*1 0.3 LQH3NP_GR
 *2 1.1±0.1 LQH3NP_GR

Embossed Tape

| Part Number | Dimensions | | Depth of Cavity | Packaging Code (Minimum Qty. (pcs.)) | | |
|-------------|------------|-----|-----------------|--------------------------------------|--------------------|---------|
| | a | b | | $\phi 180$ mm reel | $\phi 330$ mm reel | Bulk |
| LQH3NP_GR | 3.3 | 3.3 | 1.1 | L (3000) | K (11000) | — |
| LQH3NP_JR | 3.3 | 3.3 | 1.6 | L (2000) | K (8000) | — |
| LQH3NP_ME | 3.3 | 3.3 | 1.6 | L (2000) | K (8000) | B (100) |

(in mm)

Continued on the following page. ↗

Inductors for Power Lines Packaging

Continued from the preceding page. ↘

Minimum Quantity and 12mm Width Embossed Taping Dimensions



The dimension of the cavity of embossed tape is measured at the bottom side.

Embossed Tape

| Part Number | Dimensions (*c: Depth of Cavity) | | | | Packaging Code (Minimum Qty. (pcs.)) | | |
|--------------|----------------------------------|-----|-----|-----|--------------------------------------|-------------|------|
| | a | b | c | d | ø180mm reel | ø330mm reel | Bulk |
| LQH43C | 3.6 | 4.9 | 2.7 | 0.3 | L (500) | — | — |
| LQH43P | 3.6 | 4.9 | 2.7 | 0.3 | L (500) | K (2500) | — |
| LQH44P_J0/GR | 4.3 | 4.3 | 1.4 | 0.3 | L (1000) | K (4500) | — |
| LQH44P_P0 | 4.3 | 4.3 | 1.9 | 0.3 | L (1000) | K (3500) | — |
| LQH5BP_38 | 5.3 | 5.3 | 4.2 | 0.4 | L (400) | K (1500) | — |
| LQH5BP_TO | 5.3 | 5.3 | 2.4 | 0.3 | L (500) | K (3000) | — |
| LQH55D | 5.4 | 6.1 | 5.0 | 0.4 | L (350) | K (1500) | — |
| LQH66S | 6.7 | 6.7 | 5.6 | 0.4 | L (350) | K (1500) | — |

(in mm)

Continued on the following page. ↗

Inductors for Power Lines Packaging

Continued from the preceding page. ↘

Tape and Reel Dimensions



Surface Mounting Type, Reel/Tape List

| Series | Reel Size (mm) | | | Tape Size (mm) | | | | | | | Q'ty 1 Reel |
|-------------|----------------|----------|--------|----------------|----------|----------------|-----------|-----------|------|---------|----------------|
| | A | B1 | B2 | C | D | E | F | G | H | I | |
| DFE18SAN_E0 | ø180 | 9.0±0.3 | 11.4±1 | 8.0±0.2 | 3.5±0.05 | 1.15±0.1/-0.05 | 1.95±0.05 | 0.92±0.05 | 0.25 | 4.0±0.1 | 3000 |
| DFE18SAN_G0 | ø180 | 9.0±0.3 | 11.4±1 | 8.0±0.2 | 3.5±0.05 | 1.15±0.1/-0.05 | 1.95±0.05 | 1.15±0.05 | 0.25 | 4.0±0.1 | 3000 |
| DFE18SBN_E0 | ø180 | 9.0±0.3 | 11.4±1 | 8.0±0.2 | 3.5±0.05 | 1.15±0.1/-0.05 | 1.95±0.05 | 0.92±0.05 | 0.25 | 4.0±0.1 | 3000 |
| DFE201208S | ø180 | 9.0±0.3 | 11.4±1 | 8.0±0.2 | 3.5±0.05 | 1.48±0.05 | 2.28±0.05 | 1.0±0.1 | 0.25 | 4.0±0.1 | 3000 |
| DFE201210S | ø180 | 9.0±0.3 | 11.4±1 | 8.0±0.2 | 3.5±0.05 | 1.48±0.05 | 2.28±0.05 | 1.2±0.1 | 0.25 | 4.0±0.1 | 3000 |
| DFE201610C | ø180 | 9.0±0.3 | 11.4±1 | 8.0±0.2 | 3.5±0.05 | 1.85±0.1 | 2.25±0.1 | 1.1±0.1 | 0.25 | 4.0±0.1 | 3000 |
| DFE201612C | ø180 | 9.0±0.3 | 11.4±1 | 8.0±0.2 | 3.5±0.05 | 1.85±0.1 | 2.25±0.1 | 1.3±0.1 | 0.25 | 4.0±0.1 | 3000 |
| DFE252008C | ø180 | 9.0±0.3 | 11.4±1 | 8.0±0.2 | 3.5±0.05 | 2.20±0.1 | 2.75±0.1 | 1.1±0.1 | 0.25 | 4.0±0.1 | 3000 |
| DFE252010C | ø180 | 9.0±0.3 | 11.4±1 | 8.0±0.2 | 3.5±0.05 | 2.20±0.1 | 2.75±0.1 | 1.1±0.1 | 0.25 | 4.0±0.1 | 3000 |
| DFE252012C | ø180 | 9.0±0.3 | 11.4±1 | 8.0±0.2 | 3.5±0.05 | 2.20±0.1 | 2.75±0.1 | 1.3±0.1 | 0.25 | 4.0±0.1 | 3000 |
| DFE322510C | ø180 | 9.0±0.3 | 11.4±1 | 8.0±0.2 | 3.5±0.05 | 2.80±0.1 | 3.5±0.1 | 1.1±0.1 | 0.25 | 4.0±0.1 | 3000 |
| DFE322512C | ø180 | 9.0±0.3 | 11.4±1 | 8.0±0.2 | 3.5±0.1 | 2.90±0.1 | 3.6±0.1 | 1.4±0.1 | 0.25 | 4.0±0.1 | 3000 |
| DFE201610R | ø180 | 9.0±0.3 | 11.4±1 | 8.0±0.2 | 3.5±0.05 | 1.85±0.1 | 2.25±0.1 | 1.1±0.1 | 0.25 | 4.0±0.1 | 3000 |
| DFE201612R | ø180 | 9.0±0.3 | 11.4±1 | 8.0±0.2 | 3.5±0.05 | 1.85±0.1 | 2.25±0.1 | 1.3±0.1 | 0.25 | 4.0±0.1 | 3000 |
| DFE252010R | ø180 | 9.0±0.3 | 11.4±1 | 8.0±0.2 | 3.5±0.05 | 2.20±0.1 | 2.75±0.1 | 1.1±0.1 | 0.25 | 4.0±0.1 | 3000 |
| DFE252012R | ø180 | 9.0±0.3 | 11.4±1 | 8.0±0.2 | 3.5±0.05 | 2.20±0.1 | 2.75±0.1 | 1.3±0.1 | 0.25 | 4.0±0.1 | 3000 |
| DFE201610P | ø180 | 9.0±0.3 | 11.4±1 | 8.0±0.2 | 3.5±0.05 | 1.85±0.1 | 2.25±0.1 | 1.1±0.1 | 0.25 | 4.0±0.1 | 3000 |
| DFE201612P | ø180 | 9.0±0.3 | 11.4±1 | 8.0±0.2 | 3.5±0.05 | 1.85±0.1 | 2.25±0.1 | 1.3±0.1 | 0.25 | 4.0±0.1 | 3000 |
| DFE252010P | ø180 | 9.0±0.3 | 11.4±1 | 8.0±0.2 | 3.5±0.05 | 2.20±0.1 | 2.75±0.1 | 1.1±0.1 | 0.25 | 4.0±0.1 | 3000 |
| DFE252012P | ø180 | 9.0±0.3 | 11.4±1 | 8.0±0.2 | 3.5±0.05 | 2.20±0.1 | 2.75±0.1 | 1.3±0.1 | 0.25 | 4.0±0.1 | 3000 |
| DFE201610E | ø180 | 9.0±0.3 | 11.4±1 | 8.0±0.2 | 3.5±0.05 | 1.9±0.1 | 2.30±0.1 | 1.1±0.1 | 0.25 | 4.0±0.1 | 3000 |
| DFE201612E | ø180 | 9.0±0.3 | 11.4±1 | 8.0±0.2 | 3.5±0.05 | 1.9±0.1 | 2.30±0.1 | 1.3±0.1 | 0.25 | 4.0±0.1 | 3000 |
| DFE201210U | ø180 | 9.0±0.3 | 11.4±1 | 8.0±0.2 | 3.5±0.05 | 1.5±0.1 | 2.30±0.1 | 1.1±0.1 | 0.30 | 4.0±0.1 | 3000 |
| DFE252007F | ø180 | 9.0±0.3 | 11.4±1 | 8.0±0.2 | 3.5±0.05 | 2.30±0.1 | 2.80±0.1 | 0.9±0.1 | 0.25 | 4.0±0.1 | 3000 |
| DFE252008U | ø180 | 9.0±0.3 | 11.4±1 | 8.0±0.2 | 3.5±0.05 | 2.20±0.1 | 2.75±0.1 | 1.1±0.1 | 0.25 | 4.0±0.1 | 3000 |
| DFE252010F | ø180 | 9.0±0.3 | 11.4±1 | 8.0±0.2 | 3.5±0.05 | 2.30±0.1 | 2.80±0.1 | 1.1±0.1 | 0.25 | 4.0±0.1 | 3000 |
| DFE252012F | ø180 | 9.0±0.3 | 11.4±1 | 8.0±0.2 | 3.5±0.05 | 2.30±0.1 | 2.80±0.1 | 1.1±0.1 | 0.25 | 4.0±0.1 | 3000 |
| DFE322512F | ø180 | 9.0±0.3 | 11.4±1 | 8.0±0.2 | 3.5±0.1 | 2.90±0.1 | 3.6±0.1 | 1.4±0.1 | 0.25 | 4.0±0.1 | 3000 |
| FDSD0412 | ø330 | 13.5±0.5 | 17.5±1 | 12.0±0.3 | 5.5±0.1 | 4.4±0.1 | 4.4±0.1 | 1.5±0.1 | 0.3 | 8.0±0.1 | 4000 |
| FDSD0415 | ø330 | 13.5±0.5 | 17.5±1 | 12.0±0.3 | 5.5±0.1 | 4.4±0.1 | 4.4±0.1 | 1.8±0.1 | 0.3 | 8.0±0.1 | 4000 |
| FDSD0420 | ø330 | 13.5±0.5 | 17.5±1 | 12.0±0.3 | 5.5±0.1 | 4.4±0.1 | 4.4±0.1 | 2.2±0.1 | 0.3 | 8.0±0.1 | 2000 |
| FDSD0420W | ø330 | 13.5±0.5 | 17.5±1 | 12.0±0.3 | 5.5±0.1 | 4.4±0.1 | 4.4±0.1 | 2.2±0.1 | 0.3 | 8.0±0.1 | 2000 |
| FDSD0512 | ø330 | 13.5±0.5 | 17.5±1 | 12.0±0.3 | 5.5±0.1 | 5.3±0.1 | 5.6±0.1 | 1.5±0.1 | 0.3 | 8.0±0.1 | 4000 |

Continued on the following page. ↗

Inductors for Power Lines Packaging

Continued from the preceding page. ↘

| Series | Reel Size (mm) | | | Tape Size (mm) | | | | | | | Q'ty 1 Reel |
|--------------|----------------|----------|--------|----------------|----------|----------|----------|----------|-----|----------|----------------|
| | A | B1 | B2 | C | D | E | F | G | H | I | |
| FDSD0515 | ø330 | 13.5±0.5 | 17.5±1 | 12.0±0.3 | 5.5±0.1 | 5.3±0.1 | 5.6±0.1 | 1.8±0.1 | 0.3 | 8.0±0.1 | 4000 |
| FDSD0518 | ø330 | 13.5±0.5 | 17.5±1 | 12.0±0.3 | 5.5±0.1 | 5.3±0.1 | 5.6±0.1 | 2.1±0.1 | 0.4 | 8.0±0.1 | 2000 |
| FDSD0630 | ø330 | 17.5±0.5 | 21.5±1 | 16.0±0.3 | 7.5±0.1 | 7.1±0.1 | 7.8±0.1 | 3.3±0.1 | 0.4 | 12.0±0.1 | 1000 |
| FDV0530 | ø330 | 17.5±0.5 | 21.5±1 | 16.0±0.3 | 7.5±0.1 | 6.2±0.1 | 6.6±0.1 | 3.3±0.1 | 0.4 | 12.0±0.1 | 1000 |
| FDV0530S | ø330 | 13.5±0.5 | 17.5±1 | 12.0±0.3 | 5.5±0.1 | 5.4±0.1 | 5.4±0.1 | 3.3±0.1 | 0.4 | 12.0±0.3 | 1000 |
| FDV0618 | ø330 | 17.5±0.5 | 21.5±1 | 16.0±0.3 | 7.5±0.1 | 7.0±0.1 | 7.8±0.1 | 2.2±0.1 | 0.4 | 12.0±0.1 | 1500 |
| FDV0620 | ø330 | 17.5±0.5 | 21.5±1 | 16.0±0.3 | 7.5±0.1 | 7.0±0.1 | 7.8±0.1 | 2.2±0.1 | 0.4 | 12.0±0.1 | 1500 |
| FDVE0630 | ø330 | 17.5±0.5 | 21.5±1 | 16.0±0.3 | 7.5±0.1 | 7.0±0.1 | 7.8±0.1 | 3.3±0.1 | 0.4 | 12.0±0.1 | 1000 |
| FDVE0640 | ø330 | 17.5±0.5 | 21.5±1 | 16.0±0.3 | 7.5±0.1 | 7.1±0.1 | 7.8±0.1 | 4.3±0.1 | 0.4 | 12.0±0.1 | 1000 |
| FDVE1040 | ø330 | 25.5±0.5 | 29.5±1 | 24.0±0.3 | 11.5±0.1 | 10.5±0.1 | 12.1±0.1 | 4.3±0.1 | 0.4 | 16.0±0.1 | 500 |
| FDUE0630 | ø330 | 17.5±0.5 | 21.5±1 | 16.0±0.3 | 7.5±0.1 | 7.1±0.1 | 7.8±0.1 | 3.3±0.1 | 0.4 | 12.0±0.1 | 1000 |
| FDUE0640 | ø330 | 17.5±0.5 | 21.5±1 | 16.0±0.3 | 7.5±0.1 | 7.0±0.1 | 7.8±0.1 | 4.3±0.1 | 0.4 | 12.0±0.1 | 1000 |
| FDUE0650 | ø330 | 17.5±0.5 | 21.5±1 | 16.0±0.3 | 7.5±0.1 | 7.0±0.1 | 7.8±0.1 | 5.3±0.1 | 0.4 | 12.0±0.1 | 1000 |
| FDUE1040D | ø330 | 25.5±0.5 | 29.5±1 | 24.0±0.3 | 11.5±0.1 | 10.5±0.1 | 12.1±0.1 | 4.3±0.1 | 0.4 | 16.0±0.1 | 500 |
| FDUE1245 | ø330 | 25.5±0.5 | 29.5±1 | 24.0±0.3 | 11.5±0.1 | 12.3±0.1 | 13.7±0.1 | 4.7±0.1 | 0.4 | 16.0±0.1 | 500 |
| FDUE1260 | ø330 | 25.5±0.5 | 29.5±1 | 24.0±0.3 | 11.5±0.1 | 12.9±0.1 | 14.7±0.1 | 6.37±0.1 | 0.4 | 16.0±0.1 | 500 |
| FDA1055 | ø330 | 25.5±0.5 | 29.5±1 | 24.0±0.3 | 11.5±0.1 | 11.1±0.1 | 12.0±0.1 | 5.7±0.1 | 0.4 | 16.0±0.1 | 500 |
| FDA1254 | ø330 | 25.5±0.5 | 29.5±1 | 24.0±0.3 | 11.5±0.1 | 12.9±0.1 | 13.9±0.1 | 5.7±0.1 | 0.4 | 16.0±0.1 | 500 |
| FCUL0530 | ø330 | 17.5±0.5 | 21.5±1 | 16.0±0.3 | 7.5±0.1 | 6.2±0.1 | 6.6±0.1 | 3.3±0.1 | 0.4 | 12.0±0.1 | 1000 |
| FCUL0624 | ø330 | 17.5±0.5 | 21.5±1 | 16.0±0.3 | 7.5±0.1 | 7.1±0.1 | 7.8±0.1 | 2.7±0.1 | 0.4 | 12.0±0.1 | 1500 |
| FCUL0630 | ø330 | 17.5±0.5 | 21.5±1 | 16.0±0.3 | 7.5±0.1 | 7.1±0.1 | 7.8±0.1 | 3.3±0.1 | 0.4 | 12.0±0.1 | 1000 |
| FCUL1040 | ø330 | 25.5±0.5 | 29.5±1 | 24.0±0.3 | 11.5±0.1 | 10.5±0.1 | 12.1±0.1 | 4.3±0.1 | 0.4 | 16.0±0.1 | 500 |
| FCUL1060 | ø330 | 25.5±0.5 | 29.5±1 | 24.0±0.3 | 11.5±0.1 | 10.5±0.1 | 12.1±0.1 | 6.3±0.1 | 0.4 | 16.0±0.1 | 500 |
| DEM2812C | ø180 | 9.0±0.5 | 11.4±1 | 8.0±0.2 | 3.5±0.05 | 3.05±0.1 | 3.25±0.1 | 1.5±0.1 | 0.3 | 4.0±0.1 | 2000 |
| DEM2815C | ø180 | 9.0±0.5 | 11.4±1 | 8.0±0.2 | 3.5±0.05 | 3.05±0.1 | 3.25±0.1 | 1.8±0.1 | 0.3 | 4.0±0.1 | 2000 |
| DEM2818C | ø180 | 9.0±0.5 | 11.4±1 | 8.0±0.2 | 3.5±0.05 | 3.05±0.1 | 3.25±0.1 | 2.1±0.1 | 0.3 | 4.0±0.1 | 2000 |
| DEM3512C | ø330 | 13.5±0.5 | 17.5±1 | 12.0±0.3 | 5.5±0.1 | 3.75±0.1 | 3.95±0.1 | 1.4±0.1 | 0.3 | 8.0±0.1 | 2000 |
| DEM3518C | ø330 | 13.5±0.5 | 17.5±1 | 12.0±0.3 | 5.5±0.1 | 3.75±0.1 | 3.95±0.1 | 2.0±0.1 | 0.3 | 8.0±0.1 | 2000 |
| DEM4518C | ø330 | 13.5±0.5 | 17.5±1 | 12.0±0.3 | 5.5±0.1 | 4.75±0.1 | 4.95±0.1 | 2.0±0.1 | 0.3 | 8.0±0.1 | 2000 |
| D52LC | ø330 | 13.5±0.5 | 17.5±1 | 12.0±0.3 | 5.5±0.1 | 5.3±0.1 | 5.3±0.1 | 2.4±0.1 | 0.4 | 8.0±0.1 | 2000 |
| D53LC | ø330 | 13.5±0.5 | 17.5±1 | 12.0±0.3 | 5.5±0.1 | 5.3±0.1 | 5.3±0.1 | 3.4±0.1 | 0.4 | 8.0±0.1 | 2000 |
| D63LCB | ø330 | 13.5±0.5 | 17.5±1 | 12.0±0.3 | 5.5±0.1 | 6.2±0.1 | 6.3±0.1 | 3.25±0.1 | 0.3 | 12.0±0.1 | 1500 |
| DG6028C | ø330 | 13.5±0.5 | 17.5±1 | 12.0±0.3 | 5.5±0.1 | 6.4±0.1 | 6.4±0.1 | 3.4±0.1 | 0.4 | 8.0±0.1 | 1500 |
| DG6045C | ø330 | 13.5±0.5 | 17.5±1 | 12.0±0.3 | 5.5±0.1 | 6.4±0.1 | 6.4±0.1 | 5.1±0.1 | 0.4 | 8.0±0.1 | 1500 |
| DG6050C | ø330 | 13.5±0.5 | 17.5±1 | 12.0±0.3 | 5.5±0.1 | 6.4±0.1 | 6.4±0.1 | 5.6±0.1 | 0.4 | 8.0±0.1 | 1500 |
| DS75LC | ø330 | 17.5±0.5 | 21.5±1 | 16.0±0.3 | 7.5±0.1 | 7.8±0.1 | 7.8±0.1 | 5.4±0.1 | 0.4 | 12.0±0.1 | 1000 |
| DG8040C | ø330 | 17.5±0.5 | 21.5±1 | 16.0±0.3 | 7.5±0.1 | 8.4±0.1 | 8.4±0.1 | 4.2±0.1 | 0.4 | 12.0±0.1 | 1000 |
| DEM8030C | ø330 | 17.5±0.5 | 21.5±1 | 16.0±0.3 | 7.5±0.1 | 8.4±0.1 | 8.4±0.1 | 3.2±0.1 | 0.4 | 12.0±0.1 | 1000 |
| DEM8040C | ø330 | 17.5±0.5 | 21.5±1 | 16.0±0.3 | 7.5±0.1 | 8.4±0.1 | 8.4±0.1 | 4.2±0.1 | 0.4 | 12.0±0.1 | 1000 |
| DEM8045C | ø330 | 17.5±0.5 | 21.5±1 | 16.0±0.3 | 7.5±0.1 | 8.4±0.1 | 8.4±0.1 | 4.7±0.1 | 0.4 | 12.0±0.1 | 1000 |
| DEM10050C | ø330 | 25.5±0.5 | 29.5±1 | 24.0±0.3 | 11.5±0.1 | 10.6±0.1 | 10.6±0.1 | 5.2±0.1 | 0.4 | 16.0±0.1 | 500 |
| DEM10050C_DD | ø330 | 25.5±0.5 | 29.5±1 | 24.0±0.3 | 11.5±0.1 | 10.6±0.1 | 10.6±0.1 | 5.2±0.1 | 0.4 | 16.0±0.1 | 500 |
| DS104C2 | ø330 | 25.5±0.5 | 29.5±1 | 24.0±0.3 | 11.5±0.1 | 10.5±0.1 | 10.5±0.1 | 5.0±0.1 | 0.4 | 16.0±0.1 | 500 |
| DS106C2 | ø330 | 25.5±0.5 | 29.5±1 | 24.0±0.3 | 11.5±0.1 | 10.5±0.1 | 10.5±0.1 | 6.9±0.1 | 0.4 | 16.0±0.1 | 500 |
| DS126C2 | ø330 | 25.5±0.5 | 29.5±1 | 24.0±0.3 | 11.5±0.1 | 12.9±0.1 | 12.9±0.1 | 6.9±0.1 | 0.4 | 16.0±0.1 | 500 |

Inductors for General Circuits

| | |
|------------------------------|------|
| Part Numbering | p154 |
| Product Detail | p155 |
| ⚠Caution/Notice | p172 |
| Soldering and Mounting | p174 |
| Packaging | p178 |

● Part Numbering

Inductors for General Use



① Product ID

| Product ID | |
|------------|-----------------------------|
| LQ | Chip Inductors (Chip Coils) |

② Structure

| Code | Structure |
|------|--------------------------------|
| B | Multilayer Type (Ferrite Core) |
| H | Wire Wound Type (Ferrite Core) |
| M | Multilayer Type (Ferrite Core) |
| W | Wire Wound Type (Ferrite Core) |

② Dimensions (LxW)

| Code | Nominal Dimensions (LxW) | Size Code (in inch) |
|------|--------------------------|---------------------|
| 04 | 0.8x0.4mm | 03019 |
| 15 | 1.0x0.5mm | 0402 |
| 18 | 1.6x0.8mm | 0603 |
| 21 | 2.0x1.25mm | 0805 |
| 31 | 3.2x1.6mm | 1206 |
| 32 | 3.2x2.5mm | 1210 |
| 43 | 4.5x3.2mm | 1812 |
| 44 | 4.0x4.0mm | 1515 |

④ Applications and Characteristics

| Code | Series | Applications and Characteristics |
|------|---------|-------------------------------------|
| C | LQW | for Choke |
| N | LQB/LQM | for Resonant Circuit |
| J | LQM | for Resonant Circuit |
| N | LQH | for Resonant Circuit |
| M | | for Resonant Circuit (Coating Type) |

⑤ Category

| Code | Category | |
|------|----------|----------------------------------|
| A | General | Impedance Device (Near GHz Band) |
| N | General | Standard Type |

⑥ Inductance

Expressed by three-digit alphanumeric. The unit is micro-henry (μH). The first and second figures are significant digits, and the third figure expresses the number of zeros that follow the two figures. If there is a decimal point, it is expressed by the capital letter "R." In this case, all figures are significant digits. If inductance is less than $0.1\mu\text{H}$, the inductance code is expressed by a combination of two figures and the capital letter "N," and the unit of inductance is nano-henry (nH). The capital letter "N" indicates the unit of "nH," and also expresses a decimal point. In this case, all figures are significant digits.

⑦ Inductance Tolerance

| Code | Inductance Tolerance |
|------|----------------------|
| J | $\pm 5\%$ |
| K | $\pm 10\%$ |
| M | $\pm 20\%$ |
| N | $\pm 30\%$ |

⑧ Features

| Code | Features | Series |
|------|---------------|------------------|
| 0 | Standard Type | LQM*1 /LQH*2/LQW |
| 1 | Standard Type | LQB/LQM21N |
| 2 | Standard Type | LQH32M |

*1 Except for LQM21N Series

*2 Except for LQH32 Series

⑨ Electrode

•Lead (Pb) Free

| Code | Electrode | Series |
|------|-----------|-------------|
| 0 | Sn | LQB/LQM/LQW |
| 3 | LF Solder | LQH |

⑩ Packaging

| Code | Packaging |
|------|---|
| K | Embossed Taping ($\phi 330\text{mm}$ Reel) |
| L | Embossed Taping ($\phi 180\text{mm}$ Reel) |
| B | Bulk |
| J | Paper Taping ($\phi 330\text{mm}$ Reel) |
| D | Paper Taping ($\phi 180\text{mm}$ Reel) |

Inductors for General Circuits

LQW04CA_00 Series 03019 (0805) inch (mm)



| Packaging Code | Packaging | Minimum Quantity |
|----------------|---------------------|------------------|
| D | ø180mm Paper Taping | 10000 |
| B | Packing in Bulk | 500 |

| Part Number (□: packaging code) | Inductance | Inductance Test Frequency | Rated Current | Max. of DC Resistance | S.R.F.* (min.) |
|------------------------------------|------------|---------------------------|---------------|-----------------------|----------------|
| LQW04CA60NK00□ | 60nH ±10% | 100MHz | 620mA | 0.18Ω | 3000MHz |
| LQW04CA90NK00□ | 90nH ±10% | 100MHz | 520mA | 0.24Ω | 2500MHz |
| LQW04CAR12K00□ | 120nH ±10% | 100MHz | 510mA | 0.28Ω | 2100MHz |
| LQW04CAR29K00□ | 290nH ±10% | 100MHz | 270mA | 0.94Ω | 1400MHz |
| LQW04CAR45K00□ | 450nH ±10% | 100MHz | 200mA | 1.23Ω | 850MHz |
| LQW04CAR51K00□ | 510nH ±10% | 100MHz | 200mA | 1.31Ω | 700MHz |

Operating temp. range: -40 to 85°C
 Class of Magnetic Shield: No Shield
 Only for reflow soldering
 *S.R.F.: Self Resonant Frequency

Inductance-Frequency Characteristics (Typ.)



Impedance-Frequency Characteristics (Typ.)



LQW15CA_00 Series 0402 (1005) inch (mm)



| Packaging Code | Packaging | Minimum Quantity |
|----------------|---------------------|------------------|
| D | ø180mm Paper Taping | 10000 |
| B | Packing in Bulk | 500 |

Continued on the following page. ↗

Continued from the preceding page. ↘

| Part Number (□: packaging code) | Inductance | Inductance Test Frequency | Rated Current | Max. of DC Resistance | S.R.F.* (min.) | Remark |
|------------------------------------|-------------|------------------------------|---------------|-----------------------|----------------|--------|
| LQW15CA22NJ00□ | 22nH ±5% | 10MHz | 1300mA | 0.06Ω | 3000MHz | *1 |
| LQW15CA22NK00□ | 22nH ±10% | 10MHz | 1300mA | 0.06Ω | 3000MHz | *1 |
| LQW15CA39NJ00□ | 39nH ±5% | 10MHz | 1100mA | 0.075Ω | 2700MHz | *2 |
| LQW15CA39NK00□ | 39nH ±10% | 10MHz | 1100mA | 0.075Ω | 2700MHz | *2 |
| LQW15CA59NJ00□ | 59nH ±5% | 10MHz | 1000mA | 0.095Ω | 2300MHz | *3 |
| LQW15CA59NK00□ | 59nH ±10% | 10MHz | 1000mA | 0.095Ω | 2300MHz | *3 |
| LQW15CA83NJ00□ | 83nH ±5% | 10MHz | 970mA | 0.12Ω | 1700MHz | *4 |
| LQW15CA83NK00□ | 83nH ±10% | 10MHz | 970mA | 0.12Ω | 1700MHz | *4 |
| LQW15CAR11J00□ | 110nH ±5% | 10MHz | 900mA | 0.13Ω | 1600MHz | *5 |
| LQW15CAR11K00□ | 110nH ±10% | 10MHz | 900mA | 0.13Ω | 1600MHz | *5 |
| LQW15CAR14J00□ | 140nH ±5% | 10MHz | 680mA | 0.18Ω | 1400MHz | *6 |
| LQW15CAR14K00□ | 140nH ±10% | 10MHz | 680mA | 0.18Ω | 1400MHz | *6 |
| LQW15CAR18J00□ | 180nH ±5% | 10MHz | 640mA | 0.21Ω | 1300MHz | *7 |
| LQW15CAR18K00□ | 180nH ±10% | 10MHz | 640mA | 0.21Ω | 1300MHz | *7 |
| LQW15CAR22J00□ | 220nH ±5% | 10MHz | 540mA | 0.29Ω | 1300MHz | *8 |
| LQW15CAR22K00□ | 220nH ±10% | 10MHz | 540mA | 0.29Ω | 1300MHz | *8 |
| LQW15CAR27J00□ | 270nH ±5% | 10MHz | 480mA | 0.38Ω | 1200MHz | *9 |
| LQW15CAR27K00□ | 270nH ±10% | 10MHz | 480mA | 0.38Ω | 1200MHz | *9 |
| LQW15CAR32J00□ | 320nH ±5% | 10MHz | 420mA | 0.41Ω | 1100MHz | *10 |
| LQW15CAR32K00□ | 320nH ±10% | 10MHz | 420mA | 0.41Ω | 1100MHz | *10 |
| LQW15CAR37J00□ | 370nH ±5% | 10MHz | 360mA | 0.575Ω | 1000MHz | *11 |
| LQW15CAR37K00□ | 370nH ±10% | 10MHz | 360mA | 0.575Ω | 1000MHz | *11 |
| LQW15CAR39J00□ | 390nH ±5% | 10MHz | 320mA | 0.72Ω | 950MHz | *12 |
| LQW15CAR39K00□ | 390nH ±10% | 10MHz | 320mA | 0.72Ω | 950MHz | *12 |
| LQW15CAR43J00□ | 430nH ±5% | 10MHz | 360mA | 0.68Ω | 920MHz | *13 |
| LQW15CAR43K00□ | 430nH ±10% | 10MHz | 360mA | 0.68Ω | 920MHz | *13 |
| LQW15CAR50J00□ | 500nH ±5% | 10MHz | 270mA | 0.97Ω | 900MHz | *14 |
| LQW15CAR50K00□ | 500nH ±10% | 10MHz | 270mA | 0.97Ω | 900MHz | *14 |
| LQW15CAR56J00□ | 560nH ±5% | 10MHz | 270mA | 1.00Ω | 900MHz | *15 |
| LQW15CAR56K00□ | 560nH ±10% | 10MHz | 270mA | 1.00Ω | 900MHz | *15 |
| LQW15CAR64J00□ | 640nH ±5% | 10MHz | 240mA | 1.40Ω | 870MHz | *16 |
| LQW15CAR64K00□ | 640nH ±10% | 10MHz | 240mA | 1.40Ω | 870MHz | *16 |
| LQW15CAR73J00□ | 730nH ±5% | 10MHz | 200mA | 1.95Ω | 810MHz | *17 |
| LQW15CAR73K00□ | 730nH ±10% | 10MHz | 200mA | 1.95Ω | 810MHz | *17 |
| LQW15CAR80J00□ | 800nH ±5% | 10MHz | 190mA | 2.10Ω | 770MHz | *18 |
| LQW15CAR80K00□ | 800nH ±10% | 10MHz | 190mA | 2.10Ω | 770MHz | *18 |
| LQW15CA1R0K00□ | 1000nH ±10% | 10MHz | 180mA | 2.2Ω | 400MHz | *19 |

Operating temp. range (Self-temp. rise included): -40 to 125°C

Class of Magnetic Shield: No Shield

Only for reflow soldering

*S.R.F.: Self Resonant Frequency

*1: Typical impedance: 100Ω (typ) @ 900MHz/150Ω (typ) @ 1.7GHz

*2: Typical impedance: 180Ω (typ) @ 900MHz/280Ω (typ) @ 1.7GHz

*3: Typical impedance: 290Ω (typ) @ 900MHz/360Ω (typ) @ 1.7GHz

*4: Typical impedance: 430Ω (typ) @ 900MHz/750Ω (typ) @ 1.7GHz

*5: Typical impedance: 580Ω (typ) @ 900MHz/1000Ω (typ) @ 1.7GHz

*6: Typical impedance: 780Ω (typ) @ 900MHz/1300Ω (typ) @ 1.7GHz

*7: Typical impedance: 1000Ω (typ) @ 900MHz/1700Ω (typ) @ 1.7GHz

*8: Typical impedance: 1400Ω (typ) @ 900MHz/2000Ω (typ) @ 1.7GHz

*9: Typical impedance: 1800Ω (typ) @ 900MHz/2100Ω (typ) @ 1.7GHz

*10: Typical impedance: 2200Ω (typ) @ 900MHz/2300Ω (typ) @ 1.7GHz

*11: Typical impedance: 2800Ω (typ) @ 900MHz/2350Ω (typ) @ 1.7GHz

*12: Typical impedance: 3000Ω (typ) @ 900MHz/2400Ω (typ) @ 1.7GHz

*13: Typical impedance: 3400Ω (typ) @ 900MHz/2400Ω (typ) @ 1.7GHz

*14: Typical impedance: 4250Ω (typ) @ 900MHz/2400Ω (typ) @ 1.7GHz

*15: Typical impedance: 4950Ω (typ) @ 900MHz/2350Ω (typ) @ 1.7GHz

*16: Typical impedance: 5800Ω (typ) @ 900MHz/2400Ω (typ) @ 1.7GHz

*17: Typical impedance: 6500Ω (typ) @ 900MHz/2450Ω (typ) @ 1.7GHz

*18: Typical impedance: 7000Ω (typ) @ 900MHz/2500Ω (typ) @ 1.7GHz

*19: Typical impedance: 5200Ω (typ) @ 900MHz/1600Ω (typ) @ 1.7GHz

*20: Typical impedance: 510Ω (typ) @ 900MHz/610Ω (typ) @ 1.7GHz

Continued on the following page. ↗

Continued from the preceding page. ↘

| Part Number (□: packaging code) | Inductance | Inductance Test Frequency | Rated Current | Max. of DC Resistance | S.R.F.* (min.) | Remark |
|------------------------------------|-------------|------------------------------|---------------|-----------------------|----------------|--------|
| LQW15CA2R0K00□ | 2000nH ±10% | 10MHz | 130mA | 3.2Ω | 120MHz | *20 |

Operating temp. range (Self-temp. rise included): -40 to 125°C
 Class of Magnetic Shield: No Shield

Only for reflow soldering

*S.R.F.: Self Resonant Frequency

- *1: Typical impedance: 100Ω (typ) @ 900MHz/150Ω (typ) @ 1.7GHz
- *2: Typical impedance: 180Ω (typ) @ 900MHz/280Ω (typ) @ 1.7GHz
- *3: Typical impedance: 290Ω (typ) @ 900MHz/360Ω (typ) @ 1.7GHz
- *4: Typical impedance: 430Ω (typ) @ 900MHz/750Ω (typ) @ 1.7GHz
- *5: Typical impedance: 580Ω (typ) @ 900MHz/1000Ω (typ) @ 1.7GHz
- *6: Typical impedance: 780Ω (typ) @ 900MHz/1300Ω (typ) @ 1.7GHz
- *7: Typical impedance: 1000Ω (typ) @ 900MHz/1700Ω (typ) @ 1.7GHz
- *8: Typical impedance: 1400Ω (typ) @ 900MHz/2000Ω (typ) @ 1.7GHz
- *9: Typical impedance: 1800Ω (typ) @ 900MHz/2100Ω (typ) @ 1.7GHz
- *10: Typical impedance: 2200Ω (typ) @ 900MHz/2300Ω (typ) @ 1.7GHz
- *11: Typical impedance: 2800Ω (typ) @ 900MHz/2350Ω (typ) @ 1.7GHz
- *12: Typical impedance: 3000Ω (typ) @ 900MHz/2400Ω (typ) @ 1.7GHz
- *13: Typical impedance: 3400Ω (typ) @ 900MHz/2400Ω (typ) @ 1.7GHz
- *14: Typical impedance: 4250Ω (typ) @ 900MHz/2400Ω (typ) @ 1.7GHz
- *15: Typical impedance: 4950Ω (typ) @ 900MHz/2350Ω (typ) @ 1.7GHz
- *16: Typical impedance: 5800Ω (typ) @ 900MHz/2400Ω (typ) @ 1.7GHz
- *17: Typical impedance: 6500Ω (typ) @ 900MHz/2450Ω (typ) @ 1.7GHz
- *18: Typical impedance: 7000Ω (typ) @ 900MHz/2500Ω (typ) @ 1.7GHz
- *19: Typical impedance: 5200Ω (typ) @ 900MHz/1600Ω (typ) @ 1.7GHz
- *20: Typical impedance: 510Ω (typ) @ 900MHz/610Ω (typ) @ 1.7GHz

Inductance-Frequency Characteristics (Typ.)



Impedance-Frequency Characteristics (Typ.)



LQW18CA_00 Series 0603 (1608) inch (mm)



| Packaging Code | Packaging | Minimum Quantity |
|----------------|---------------------|------------------|
| D | ø180mm Paper Taping | 4000 |
| J | ø330mm Paper Taping | 10000 |
| B | Packing in Bulk | 500 |

Continued on the following page. ↗

Continued from the preceding page. ↘

| Part Number (□: packaging code) | Inductance | Inductance Test Frequency | Rated Current | Max. of DC Resistance | S.R.F.* (min.) |
|------------------------------------|------------|------------------------------|---------------|-----------------------|----------------|
| LQW18CA32NJ00□ | 32nH ±5% | 10MHz | 2200mA | 0.030Ω | 3000MHz |
| LQW18CA56NJ00□ | 56nH ±5% | 10MHz | 1850mA | 0.040Ω | 2200MHz |
| LQW18CA85NJ00□ | 85nH ±5% | 10MHz | 1650mA | 0.048Ω | 1800MHz |
| LQW18CAR12J00□ | 120nH ±5% | 10MHz | 1500mA | 0.058Ω | 1500MHz |
| LQW18CAR16J00□ | 160nH ±5% | 10MHz | 1300mA | 0.075Ω | 1350MHz |
| LQW18CAR21J00□ | 210nH ±5% | 10MHz | 1050mA | 0.115Ω | 1150MHz |
| LQW18CAR27J00□ | 270nH ±5% | 10MHz | 900mA | 0.150Ω | 1050MHz |
| LQW18CAR33J00□ | 330nH ±5% | 10MHz | 780mA | 0.200Ω | 970MHz |
| LQW18CAR40J00□ | 400nH ±5% | 10MHz | 680mA | 0.260Ω | 900MHz |
| LQW18CAR48J00□ | 480nH ±5% | 10MHz | 580mA | 0.350Ω | 800MHz |
| LQW18CAR58J00□ | 580nH ±5% | 10MHz | 450mA | 0.460Ω | 760MHz |

Operating temp. range: -40 to 85°C
 Class of Magnetic Shield: No Shield
 Only for reflow soldering
 *S.R.F.: Self Resonant Frequency

Inductance-Frequency Characteristics (Typ.)



Impedance-Frequency Characteristics (Typ.)



LQH31MN_03 Series 1206 (3216) inch (mm)



| Packaging Code | Packaging | Minimum Quantity |
|----------------|------------------------|------------------|
| K | ø330mm Embossed Taping | 7500 |
| L | ø180mm Embossed Taping | 2000 |

| Part Number (□: packaging code) | Inductance | Inductance Test Frequency | Q (min.) | Q Test Frequency | Rated Current | DC Resistance | S.R.F.* (min.) |
|------------------------------------|-------------|------------------------------|----------|------------------|---------------|---------------|----------------|
| LQH31MNR15K03□ | 0.15μH ±10% | 1MHz | 20 | 25.2MHz | 250mA | 0.39Ω±40% | 250MHz |
| LQH31MNR22K03□ | 0.22μH ±10% | 1MHz | 20 | 25.2MHz | 240mA | 0.43Ω±40% | 250MHz |
| LQH31MNR33K03□ | 0.33μH ±10% | 1MHz | 30 | 25.2MHz | 230mA | 0.45Ω±40% | 250MHz |
| LQH31MNR47K03□ | 0.47μH ±10% | 1MHz | 30 | 25.2MHz | 215mA | 0.83Ω±40% | 200MHz |
| LQH31MNR56K03□ | 0.56μH ±10% | 1MHz | 30 | 25.2MHz | 200mA | 0.61Ω±40% | 180MHz |
| LQH31MNR68K03□ | 0.68μH ±10% | 1MHz | 30 | 25.2MHz | 190mA | 0.67Ω±40% | 160MHz |
| LQH31MNR82K03□ | 0.82μH ±10% | 1MHz | 30 | 25.2MHz | 185mA | 0.73Ω±40% | 120MHz |
| LQH31MN1R0K03□ | 1.0μH ±10% | 1MHz | 35 | 10MHz | 175mA | 0.49Ω±30% | 100MHz |

Operating temp. range: -40 to 85°C
 Class of Magnetic Shield: No Shield
 *S.R.F.: Self Resonant Frequency

When rated current is applied to the products, self-temperature rise shall be limited to 20°C max and inductance will be within ±10% of initial inductance value.

Continued from the preceding page. ↘

| Part Number (□: packaging code) | Inductance | Inductance Test Frequency | Q (min.) | Q Test Frequency | Rated Current | DC Resistance | S.R.F.* (min.) |
|------------------------------------|------------|------------------------------|----------|------------------|---------------|---------------|----------------|
| LQH31MN1R2J03□ | 1.2μH ±5% | 1MHz | 35 | 10MHz | 165mA | 0.37Ω±30% | 90MHz |
| LQH31MN1R2K03□ | 1.2μH ±10% | 1MHz | 35 | 10MHz | 165mA | 0.9Ω±30% | 90MHz |
| LQH31MN1R5J03□ | 1.5μH ±5% | 1MHz | 35 | 10MHz | 155mA | 1.0Ω±30% | 75MHz |
| LQH31MN1R5K03□ | 1.5μH ±10% | 1MHz | 35 | 10MHz | 155mA | 1.0Ω±30% | 75MHz |
| LQH31MN1R8J03□ | 1.8μH ±5% | 1MHz | 35 | 10MHz | 150mA | 1.6Ω±30% | 60MHz |
| LQH31MN1R8K03□ | 1.8μH ±10% | 1MHz | 35 | 10MHz | 150mA | 1.6Ω±30% | 60MHz |
| LQH31MN2R2J03□ | 2.2μH ±5% | 1MHz | 35 | 10MHz | 140mA | 0.7Ω±30% | 50MHz |
| LQH31MN2R2K03□ | 2.2μH ±10% | 1MHz | 35 | 10MHz | 140mA | 0.7Ω±30% | 50MHz |
| LQH31MN2R7J03□ | 2.7μH ±5% | 1MHz | 35 | 10MHz | 135mA | 0.55Ω±30% | 43MHz |
| LQH31MN2R7K03□ | 2.7μH ±10% | 1MHz | 35 | 10MHz | 135mA | 0.55Ω±30% | 43MHz |
| LQH31MN3R3J03□ | 3.3μH ±5% | 1MHz | 35 | 8MHz | 130mA | 0.61Ω±30% | 38MHz |
| LQH31MN3R3K03□ | 3.3μH ±10% | 1MHz | 35 | 8MHz | 130mA | 0.61Ω±30% | 38MHz |
| LQH31MN3R9J03□ | 3.9μH ±5% | 1MHz | 35 | 8MHz | 125mA | 1.5Ω±30% | 35MHz |
| LQH31MN3R9K03□ | 3.9μH ±10% | 1MHz | 35 | 8MHz | 125mA | 1.5Ω±30% | 35MHz |
| LQH31MN4R7J03□ | 4.7μH ±5% | 1MHz | 35 | 8MHz | 120mA | 1.7Ω±30% | 31MHz |
| LQH31MN4R7K03□ | 4.7μH ±10% | 1MHz | 35 | 8MHz | 120mA | 1.7Ω±30% | 31MHz |
| LQH31MN5R6J03□ | 5.6μH ±5% | 1MHz | 35 | 8MHz | 115mA | 1.8Ω±30% | 28MHz |
| LQH31MN5R6K03□ | 5.6μH ±10% | 1MHz | 35 | 8MHz | 115mA | 1.8Ω±30% | 28MHz |
| LQH31MN6R8J03□ | 6.8μH ±5% | 1MHz | 35 | 8MHz | 110mA | 2.0Ω±30% | 25MHz |
| LQH31MN6R8K03□ | 6.8μH ±10% | 1MHz | 35 | 8MHz | 110mA | 2.0Ω±30% | 25MHz |
| LQH31MN8R2J03□ | 8.2μH ±5% | 1MHz | 35 | 8MHz | 105mA | 2.2Ω±30% | 23MHz |
| LQH31MN8R2K03□ | 8.2μH ±10% | 1MHz | 35 | 8MHz | 105mA | 2.2Ω±30% | 23MHz |
| LQH31MN100J03□ | 10μH ±5% | 1MHz | 35 | 5MHz | 100mA | 2.5Ω±30% | 20MHz |
| LQH31MN100K03□ | 10μH ±10% | 1MHz | 35 | 5MHz | 100mA | 2.5Ω±30% | 20MHz |
| LQH31MN120J03□ | 12μH ±5% | 1MHz | 35 | 5MHz | 95mA | 2.7Ω±30% | 18MHz |
| LQH31MN120K03□ | 12μH ±10% | 1MHz | 35 | 5MHz | 95mA | 2.7Ω±30% | 18MHz |
| LQH31MN150J03□ | 15μH ±5% | 1MHz | 35 | 5MHz | 90mA | 3.0Ω±30% | 16MHz |
| LQH31MN150K03□ | 15μH ±10% | 1MHz | 35 | 5MHz | 90mA | 3.0Ω±30% | 16MHz |
| LQH31MN180J03□ | 18μH ±5% | 1MHz | 35 | 5MHz | 85mA | 3.4Ω±30% | 15MHz |
| LQH31MN180K03□ | 18μH ±10% | 1MHz | 35 | 5MHz | 85mA | 3.4Ω±30% | 15MHz |
| LQH31MN220J03□ | 22μH ±5% | 1MHz | 40 | 2.5MHz | 85mA | 3.1Ω±30% | 14MHz |
| LQH31MN220K03□ | 22μH ±10% | 1MHz | 40 | 2.5MHz | 85mA | 3.1Ω±30% | 14MHz |
| LQH31MN270J03□ | 27μH ±5% | 1MHz | 40 | 2.5MHz | 85mA | 3.4Ω±30% | 13MHz |
| LQH31MN270K03□ | 27μH ±10% | 1MHz | 40 | 2.5MHz | 85mA | 3.4Ω±30% | 13MHz |
| LQH31MN330J03□ | 33μH ±5% | 1MHz | 40 | 2.5MHz | 80mA | 3.8Ω±30% | 12MHz |
| LQH31MN330K03□ | 33μH ±10% | 1MHz | 40 | 2.5MHz | 80mA | 3.8Ω±30% | 12MHz |
| LQH31MN390J03□ | 39μH ±5% | 1MHz | 40 | 2.5MHz | 55mA | 7.2Ω±30% | 11MHz |
| LQH31MN390K03□ | 39μH ±10% | 1MHz | 40 | 2.5MHz | 55mA | 7.2Ω±30% | 11MHz |
| LQH31MN470J03□ | 47μH ±5% | 1MHz | 40 | 2.5MHz | 55mA | 8.0Ω±30% | 10MHz |
| LQH31MN470K03□ | 47μH ±10% | 1MHz | 40 | 2.5MHz | 55mA | 8.0Ω±30% | 10MHz |
| LQH31MN560J03□ | 56μH ±5% | 1MHz | 40 | 2.5MHz | 50mA | 8.9Ω±30% | 9.0MHz |
| LQH31MN560K03□ | 56μH ±10% | 1MHz | 40 | 2.5MHz | 50mA | 8.9Ω±30% | 9.0MHz |
| LQH31MN680J03□ | 68μH ±5% | 1MHz | 40 | 2.5MHz | 50mA | 9.9Ω±30% | 8.5MHz |
| LQH31MN680K03□ | 68μH ±10% | 1MHz | 40 | 2.5MHz | 50mA | 9.9Ω±30% | 8.5MHz |
| LQH31MN820J03□ | 82μH ±5% | 1MHz | 40 | 2.5MHz | 45mA | 11.0Ω±30% | 7.5MHz |
| LQH31MN820K03□ | 82μH ±10% | 1MHz | 40 | 2.5MHz | 45mA | 11.0Ω±30% | 7.5MHz |
| LQH31MN101J03□ | 100μH ±5% | 1MHz | 40 | 2.5MHz | 45mA | 12.0Ω±30% | 7.0MHz |
| LQH31MN101K03□ | 100μH ±10% | 1MHz | 40 | 2.5MHz | 45mA | 12.0Ω±30% | 7.0MHz |

Operating temp. range: -40 to 85°C

Class of Magnetic Shield: No Shield

*S.R.F.: Self Resonant Frequency

When rated current is applied to the products, self-temperature rise shall be limited to 20°C max and inductance will be within ±10% of initial inductance value.

Continued on the following page. ↗

Continued from the preceding page. ↘

Inductance-Frequency Characteristics (Typ.)



Q-Frequency Characteristics (Typ.)



LQH32MN_23 Series 1210 (3225) inch (mm)



| Packaging Code | Packaging | Minimum Quantity |
|----------------|------------------------|------------------|
| K | ø330mm Embossed Taping | 7500 |
| L | ø180mm Embossed Taping | 2000 |

| Part Number (□: packaging code) | Inductance | Inductance Test Frequency | Q (min.) | Q Test Frequency | Rated Current | Max. of DC Resistance | S.R.F.* (min.) |
|------------------------------------|------------|---------------------------|----------|------------------|---------------|-----------------------|----------------|
| LQH32MN1R0M23□ | 1.0μH ±20% | 1MHz | 20 | 1MHz | 445mA | 0.5Ω | 100MHz |
| LQH32MN1R2M23□ | 1.2μH ±20% | 1MHz | 20 | 1MHz | 425mA | 0.6Ω | 100MHz |
| LQH32MN1R5K23□ | 1.5μH ±10% | 1MHz | 20 | 1MHz | 400mA | 0.6Ω | 75MHz |
| LQH32MN1R8K23□ | 1.8μH ±10% | 1MHz | 20 | 1MHz | 390mA | 0.7Ω | 60MHz |
| LQH32MN2R2K23□ | 2.2μH ±10% | 1MHz | 20 | 1MHz | 370mA | 0.8Ω | 50MHz |
| LQH32MN2R7K23□ | 2.7μH ±10% | 1MHz | 20 | 1MHz | 320mA | 0.9Ω | 43MHz |
| LQH32MN3R3K23□ | 3.3μH ±10% | 1MHz | 20 | 1MHz | 300mA | 1.0Ω | 38MHz |
| LQH32MN3R9K23□ | 3.9μH ±10% | 1MHz | 20 | 1MHz | 290mA | 1.1Ω | 35MHz |
| LQH32MN4R7K23□ | 4.7μH ±10% | 1MHz | 20 | 1MHz | 270mA | 1.2Ω | 31MHz |
| LQH32MN5R6K23□ | 5.6μH ±10% | 1MHz | 20 | 1MHz | 250mA | 1.3Ω | 28MHz |
| LQH32MN6R8K23□ | 6.8μH ±10% | 1MHz | 20 | 1MHz | 240mA | 1.5Ω | 25MHz |
| LQH32MN8R2K23□ | 8.2μH ±10% | 1MHz | 20 | 1MHz | 225mA | 1.6Ω | 23MHz |
| LQH32MN100J23□ | 10μH ±5% | 1MHz | 35 | 1MHz | 190mA | 1.8Ω | 20MHz |
| LQH32MN100K23□ | 10μH ±10% | 1MHz | 35 | 1MHz | 190mA | 1.8Ω | 20MHz |
| LQH32MN120J23□ | 12μH ±5% | 1MHz | 35 | 1MHz | 180mA | 2.0Ω | 18MHz |
| LQH32MN120K23□ | 12μH ±10% | 1MHz | 35 | 1MHz | 180mA | 2.0Ω | 18MHz |
| LQH32MN150J23□ | 15μH ±5% | 1MHz | 35 | 1MHz | 170mA | 2.2Ω | 16MHz |
| LQH32MN150K23□ | 15μH ±10% | 1MHz | 35 | 1MHz | 170mA | 2.2Ω | 16MHz |
| LQH32MN180J23□ | 18μH ±5% | 1MHz | 35 | 1MHz | 165mA | 2.5Ω | 15MHz |
| LQH32MN180K23□ | 18μH ±10% | 1MHz | 35 | 1MHz | 165mA | 2.5Ω | 15MHz |
| LQH32MN220J23□ | 22μH ±5% | 1MHz | 35 | 1MHz | 150mA | 2.8Ω | 14MHz |
| LQH32MN220K23□ | 22μH ±10% | 1MHz | 35 | 1MHz | 150mA | 2.8Ω | 14MHz |
| LQH32MN270J23□ | 27μH ±5% | 1MHz | 35 | 1MHz | 125mA | 3.1Ω | 13MHz |
| LQH32MN270K23□ | 27μH ±10% | 1MHz | 35 | 1MHz | 125mA | 3.1Ω | 13MHz |
| LQH32MN330J23□ | 33μH ±5% | 1MHz | 40 | 1MHz | 115mA | 3.5Ω | 12MHz |
| LQH32MN330K23□ | 33μH ±10% | 1MHz | 40 | 1MHz | 115mA | 3.5Ω | 12MHz |

Operating temp. range (Self-temp. rise not included): -40 to 85°C

Class of Magnetic Shield: No Shield

*S.R.F.: Self Resonant Frequency

Continued from the preceding page. ↘

| Part Number (□: packaging code) | Inductance | Inductance Test Frequency | Q (min.) | Q Test Frequency | Rated Current | Max. of DC Resistance | S.R.F.* (min.) |
|------------------------------------|------------|---------------------------|----------|------------------|---------------|-----------------------|----------------|
| LQH32MN390J23□ | 39μH ±5% | 1MHz | 40 | 1MHz | 110mA | 3.9Ω | 11MHz |
| LQH32MN390K23□ | 39μH ±10% | 1MHz | 40 | 1MHz | 110mA | 3.9Ω | 11MHz |
| LQH32MN470J23□ | 47μH ±5% | 1MHz | 40 | 1MHz | 100mA | 4.3Ω | 11MHz |
| LQH32MN470K23□ | 47μH ±10% | 1MHz | 40 | 1MHz | 100mA | 4.3Ω | 11MHz |
| LQH32MN560J23□ | 56μH ±5% | 1MHz | 40 | 1MHz | 85mA | 4.9Ω | 10MHz |
| LQH32MN560K23□ | 56μH ±10% | 1MHz | 40 | 1MHz | 85mA | 4.9Ω | 10MHz |
| LQH32MN680J23□ | 68μH ±5% | 1MHz | 40 | 1MHz | 80mA | 5.5Ω | 9.0MHz |
| LQH32MN680K23□ | 68μH ±10% | 1MHz | 40 | 1MHz | 80mA | 5.5Ω | 9.0MHz |
| LQH32MN820J23□ | 82μH ±5% | 1MHz | 40 | 1MHz | 70mA | 6.2Ω | 8.5MHz |
| LQH32MN820K23□ | 82μH ±10% | 1MHz | 40 | 1MHz | 70mA | 6.2Ω | 8.5MHz |
| LQH32MN101J23□ | 100μH ±5% | 1MHz | 40 | 796kHz | 80mA | 7.0Ω | 8.0MHz |
| LQH32MN101K23□ | 100μH ±10% | 1MHz | 40 | 796kHz | 80mA | 7.0Ω | 8.0MHz |
| LQH32MN121J23□ | 120μH ±5% | 1MHz | 40 | 796kHz | 75mA | 8.0Ω | 7.5MHz |
| LQH32MN121K23□ | 120μH ±10% | 1MHz | 40 | 796kHz | 75mA | 8.0Ω | 7.5MHz |
| LQH32MN151J23□ | 150μH ±5% | 1MHz | 40 | 796kHz | 70mA | 9.3Ω | 7.0MHz |
| LQH32MN151K23□ | 150μH ±10% | 1MHz | 40 | 796kHz | 70mA | 9.3Ω | 7.0MHz |
| LQH32MN181J23□ | 180μH ±5% | 1MHz | 40 | 796kHz | 65mA | 10.2Ω | 6.0MHz |
| LQH32MN181K23□ | 180μH ±10% | 1MHz | 40 | 796kHz | 65mA | 10.2Ω | 6.0MHz |
| LQH32MN221J23□ | 220μH ±5% | 1MHz | 40 | 796kHz | 65mA | 11.8Ω | 5.5MHz |
| LQH32MN221K23□ | 220μH ±10% | 1MHz | 40 | 796kHz | 65mA | 11.8Ω | 5.5MHz |
| LQH32MN271J23□ | 270μH ±5% | 1MHz | 40 | 796kHz | 65mA | 12.5Ω | 5.0MHz |
| LQH32MN271K23□ | 270μH ±10% | 1MHz | 40 | 796kHz | 65mA | 12.5Ω | 5.0MHz |
| LQH32MN331J23□ | 330μH ±5% | 1MHz | 40 | 796kHz | 65mA | 13.0Ω | 5.0MHz |
| LQH32MN331K23□ | 330μH ±10% | 1MHz | 40 | 796kHz | 65mA | 13.0Ω | 5.0MHz |
| LQH32MN391J23□ | 390μH ±5% | 1MHz | 50 | 796kHz | 50mA | 22.0Ω | 5.0MHz |
| LQH32MN391K23□ | 390μH ±10% | 1MHz | 50 | 796kHz | 50mA | 22.0Ω | 5.0MHz |
| LQH32MN471J23□ | 470μH ±5% | 1kHz | 50 | 796kHz | 45mA | 25.0Ω | 5.0MHz |
| LQH32MN471K23□ | 470μH ±10% | 1kHz | 50 | 796kHz | 45mA | 25.0Ω | 5.0MHz |
| LQH32MN561J23□ | 560μH ±5% | 1kHz | 50 | 796kHz | 40mA | 28.0Ω | 5.0MHz |
| LQH32MN561K23□ | 560μH ±10% | 1kHz | 50 | 796kHz | 40mA | 28.0Ω | 5.0MHz |

Operating temp. range (Self-temp. rise not included): -40 to 85°C

Class of Magnetic Shield: No Shield

*S.R.F.: Self Resonant Frequency

Inductance-Frequency Characteristics (Typ.)



Q-Frequency Characteristics (Typ.)



Inductors for Power Lines
 Inductors for General Circuits
 RF Inductors

LQH44NN_03 Series 1515 (4040) inch (mm)



| Packaging Code | Packaging | Minimum Quantity |
|----------------|------------------------|------------------|
| K | ø330mm Embossed Taping | 1500 |
| L | ø180mm Embossed Taping | 250 |

| Part Number (□: packaging code) | Inductance | Inductance Test Frequency | Rated Current | DC Resistance | S.R.F.* (min.) |
|------------------------------------|-------------|---------------------------|---------------|---------------|----------------|
| LQH44NNR51M03□ | 0.51μH ±20% | 1kHz | 4.50A | 0.0075Ω±30% | 160MHz |
| LQH44NNR74M03□ | 0.74μH ±20% | 1kHz | 3.50A | 0.011Ω±30% | 150MHz |
| LQH44NN1R0M03□ | 1.0μH ±20% | 1kHz | 3.30A | 0.012Ω±30% | 90MHz |
| LQH44NN1R5M03□ | 1.5μH ±20% | 1kHz | 3.20A | 0.016Ω±30% | 70MHz |
| LQH44NN2R2M03□ | 2.2μH ±20% | 1kHz | 2.50A | 0.019Ω±20% | 55MHz |
| LQH44NN3R3M03□ | 3.3μH ±20% | 1kHz | 2.25A | 0.024Ω±30% | 34.8MHz |
| LQH44NN4R7M03□ | 4.7μH ±20% | 1kHz | 1.95A | 0.040Ω±30% | 23.4MHz |
| LQH44NN5R0K03□ | 5.0μH ±10% | 1kHz | 1.95A | 0.040Ω±30% | 23.4MHz |
| LQH44NN6R8K03□ | 6.8μH ±10% | 1kHz | 1.60A | 0.051Ω±30% | 19.8MHz |
| LQH44NN100K03□ | 10μH ±10% | 1kHz | 1.30A | 0.067Ω±30% | 23.5MHz |
| LQH44NN150K03□ | 15μH ±10% | 1kHz | 1.10A | 0.100Ω±30% | 11.5MHz |
| LQH44NN220K03□ | 22μH ±10% | 1kHz | 0.95A | 0.170Ω±30% | 14MHz |
| LQH44NN330K03□ | 33μH ±10% | 1kHz | 0.76A | 0.210Ω±30% | 12MHz |
| LQH44NN470K03□ | 47μH ±10% | 1kHz | 0.64A | 0.330Ω±30% | 10MHz |
| LQH44NN680K03□ | 68μH ±10% | 1kHz | 0.53A | 0.410Ω±30% | 8.0MHz |
| LQH44NN101K03□ | 100μH ±10% | 1kHz | 0.30A | 0.540Ω±30% | 6.3MHz |
| LQH44NN151K03□ | 150μH ±10% | 1kHz | 0.26A | 0.920Ω±30% | 5.2MHz |
| LQH44NN221K03□ | 220μH ±10% | 1kHz | 0.21A | 1.20Ω±30% | 3.9MHz |
| LQH44NN331K03□ | 330μH ±10% | 1kHz | 0.18A | 1.76Ω±30% | 3.0MHz |
| LQH44NN471K03□ | 470μH ±10% | 1kHz | 0.145A | 2.23Ω±30% | 2.7MHz |

Operating temp. range (Self-temp. rise included): -40 to 125°C
 Operating temp. range (Self-temp. rise not included): -40 to 85°C
 Class of Magnetic Shield: No Shield
 Only for reflow soldering
 *S.R.F.: Self Resonant Frequency

When rated current is applied to the products, inductance will be within ±30% of initial inductance value. When rated current is applied to the products, the temperature rise caused by self-generated heat shall be limited to 40°C max.

Inductance-Frequency Characteristics (Typ.)



Q-Frequency Characteristics (Typ.)



LQH43MN_03 Series 1812 (4532) inch (mm)

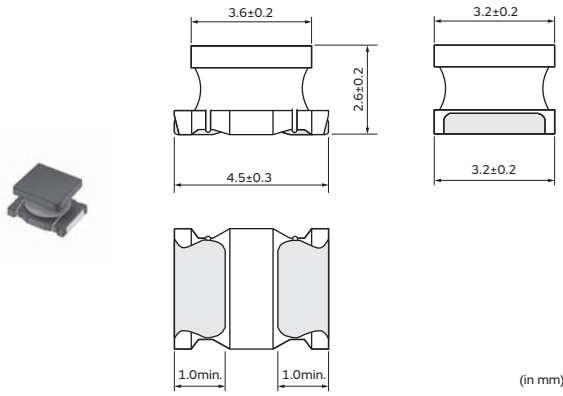

| Packaging Code | Packaging | Minimum Quantity |
|----------------|------------------------|------------------|
| K | ø330mm Embossed Taping | 2500 |
| L | ø180mm Embossed Taping | 500 |

| Part Number (□: packaging code) | Inductance | Inductance Test Frequency | Q (min.) | Q Test Frequency | Rated Current | Max. of DC Resistance | S.R.F.* (min.) |
|------------------------------------|------------|------------------------------|----------|------------------|---------------|-----------------------|----------------|
| LQH43MN1R0M03□ | 1.0μH ±20% | 1MHz | 20 | 1MHz | 500mA | 0.20Ω | 120MHz |
| LQH43MN1R2M03□ | 1.2μH ±20% | 1MHz | 20 | 1MHz | 500mA | 0.20Ω | 100MHz |
| LQH43MN1R5M03□ | 1.5μH ±20% | 1MHz | 20 | 1MHz | 500mA | 0.30Ω | 85MHz |
| LQH43MN1R8M03□ | 1.8μH ±20% | 1MHz | 20 | 1MHz | 500mA | 0.30Ω | 75MHz |
| LQH43MN2R2M03□ | 2.2μH ±20% | 1MHz | 20 | 1MHz | 500mA | 0.30Ω | 62MHz |
| LQH43MN2R7M03□ | 2.7μH ±20% | 1MHz | 20 | 1MHz | 500mA | 0.32Ω | 53MHz |
| LQH43MN3R3M03□ | 3.3μH ±20% | 1MHz | 20 | 1MHz | 500mA | 0.35Ω | 47MHz |
| LQH43MN3R9M03□ | 3.9μH ±20% | 1MHz | 20 | 1MHz | 500mA | 0.38Ω | 41MHz |
| LQH43MN4R7K03□ | 4.7μH ±10% | 1MHz | 30 | 1MHz | 500mA | 0.40Ω | 38MHz |
| LQH43MN5R6K03□ | 5.6μH ±10% | 1MHz | 30 | 1MHz | 500mA | 0.47Ω | 33MHz |
| LQH43MN6R8K03□ | 6.8μH ±10% | 1MHz | 30 | 1MHz | 450mA | 0.50Ω | 31MHz |
| LQH43MN8R2K03□ | 8.2μH ±10% | 1MHz | 30 | 1MHz | 450mA | 0.56Ω | 27MHz |
| LQH43MN100J03□ | 10μH ±5% | 1MHz | 35 | 1MHz | 400mA | 0.56Ω | 23MHz |
| LQH43MN100K03□ | 10μH ±10% | 1MHz | 35 | 1MHz | 400mA | 0.56Ω | 23MHz |
| LQH43MN120J03□ | 12μH ±5% | 1MHz | 35 | 1MHz | 380mA | 0.62Ω | 21MHz |
| LQH43MN120K03□ | 12μH ±10% | 1MHz | 35 | 1MHz | 380mA | 0.62Ω | 21MHz |
| LQH43MN150J03□ | 15μH ±5% | 1MHz | 35 | 1MHz | 360mA | 0.73Ω | 19MHz |
| LQH43MN150K03□ | 15μH ±10% | 1MHz | 35 | 1MHz | 360mA | 0.73Ω | 19MHz |
| LQH43MN180J03□ | 18μH ±5% | 1MHz | 35 | 1MHz | 340mA | 0.82Ω | 17MHz |
| LQH43MN180K03□ | 18μH ±10% | 1MHz | 35 | 1MHz | 340mA | 0.82Ω | 17MHz |
| LQH43MN220J03□ | 22μH ±5% | 1MHz | 35 | 1MHz | 320mA | 0.94Ω | 15MHz |
| LQH43MN220K03□ | 22μH ±10% | 1MHz | 35 | 1MHz | 320mA | 0.94Ω | 15MHz |
| LQH43MN270J03□ | 27μH ±5% | 1MHz | 35 | 1MHz | 300mA | 1.1Ω | 14MHz |
| LQH43MN270K03□ | 27μH ±10% | 1MHz | 35 | 1MHz | 300mA | 1.1Ω | 14MHz |
| LQH43MN330J03□ | 33μH ±5% | 1MHz | 35 | 1MHz | 270mA | 1.2Ω | 12MHz |
| LQH43MN330K03□ | 33μH ±10% | 1MHz | 35 | 1MHz | 270mA | 1.2Ω | 12MHz |
| LQH43MN390J03□ | 39μH ±5% | 1MHz | 35 | 1MHz | 240mA | 1.4Ω | 11MHz |
| LQH43MN390K03□ | 39μH ±10% | 1MHz | 35 | 1MHz | 240mA | 1.4Ω | 11MHz |
| LQH43MN470J03□ | 47μH ±5% | 1MHz | 35 | 1MHz | 220mA | 1.5Ω | 10MHz |
| LQH43MN470K03□ | 47μH ±10% | 1MHz | 35 | 1MHz | 220mA | 1.5Ω | 10MHz |
| LQH43MN560J03□ | 56μH ±5% | 1MHz | 35 | 1MHz | 200mA | 1.7Ω | 9.3MHz |
| LQH43MN560K03□ | 56μH ±10% | 1MHz | 35 | 1MHz | 200mA | 1.7Ω | 9.3MHz |
| LQH43MN680J03□ | 68μH ±5% | 1MHz | 35 | 1MHz | 180mA | 1.9Ω | 8.4MHz |
| LQH43MN680K03□ | 68μH ±10% | 1MHz | 35 | 1MHz | 180mA | 1.9Ω | 8.4MHz |
| LQH43MN820J03□ | 82μH ±5% | 1MHz | 35 | 1MHz | 170mA | 2.2Ω | 7.5MHz |
| LQH43MN820K03□ | 82μH ±10% | 1MHz | 35 | 1MHz | 170mA | 2.2Ω | 7.5MHz |
| LQH43MN101J03□ | 100μH ±5% | 1MHz | 40 | 796kHz | 160mA | 2.5Ω | 6.8MHz |
| LQH43MN101K03□ | 100μH ±10% | 1MHz | 40 | 796kHz | 160mA | 2.5Ω | 6.8MHz |
| LQH43MN121J03□ | 120μH ±5% | 1MHz | 40 | 796kHz | 150mA | 3.0Ω | 6.2MHz |

Operating temp. range: -40 to 85°C

Class of Magnetic Shield: No Shield

Only for reflow soldering

*S.R.F.: Self Resonant Frequency

When rated current is applied to the products, self-temperature rise shall be limited to 20°C max and inductance will be within ±10% of initial inductance value.

Continued on the following page. ↗

Continued from the preceding page. ↘

| Part Number (□: packaging code) | Inductance | Inductance Test Frequency | Q (min.) | Q Test Frequency | Rated Current | Max. of DC Resistance | S.R.F.* (min.) |
|------------------------------------|-------------|------------------------------|----------|------------------|---------------|-----------------------|----------------|
| LQH43MN121K03□ | 120μH ±10% | 1MHz | 40 | 796kHz | 150mA | 3.0Ω | 6.2MHz |
| LQH43MN151J03□ | 150μH ±5% | 1MHz | 40 | 796kHz | 130mA | 3.7Ω | 5.5MHz |
| LQH43MN151K03□ | 150μH ±10% | 1MHz | 40 | 796kHz | 130mA | 3.7Ω | 5.5MHz |
| LQH43MN181J03□ | 180μH ±5% | 1MHz | 40 | 796kHz | 120mA | 4.5Ω | 5.0MHz |
| LQH43MN181K03□ | 180μH ±10% | 1MHz | 40 | 796kHz | 120mA | 4.5Ω | 5.0MHz |
| LQH43MN221J03□ | 220μH ±5% | 1MHz | 40 | 796kHz | 110mA | 5.4Ω | 4.5MHz |
| LQH43MN221K03□ | 220μH ±10% | 1MHz | 40 | 796kHz | 110mA | 5.4Ω | 4.5MHz |
| LQH43MN271J03□ | 270μH ±5% | 1MHz | 40 | 796kHz | 100mA | 6.8Ω | 4.0MHz |
| LQH43MN271K03□ | 270μH ±10% | 1MHz | 40 | 796kHz | 100mA | 6.8Ω | 4.0MHz |
| LQH43MN331J03□ | 330μH ±5% | 1MHz | 40 | 796kHz | 95mA | 8.2Ω | 3.6MHz |
| LQH43MN331K03□ | 330μH ±10% | 1MHz | 40 | 796kHz | 95mA | 8.2Ω | 3.6MHz |
| LQH43MN391J03□ | 390μH ±5% | 1MHz | 40 | 796kHz | 90mA | 9.7Ω | 3.3MHz |
| LQH43MN391K03□ | 390μH ±10% | 1MHz | 40 | 796kHz | 90mA | 9.7Ω | 3.3MHz |
| LQH43MN471J03□ | 470μH ±5% | 1kHz | 40 | 796kHz | 80mA | 11.8Ω | 3.0MHz |
| LQH43MN471K03□ | 470μH ±10% | 1kHz | 40 | 796kHz | 80mA | 11.8Ω | 3.0MHz |
| LQH43MN561J03□ | 560μH ±5% | 1kHz | 40 | 796kHz | 70mA | 14.5Ω | 2.7MHz |
| LQH43MN561K03□ | 560μH ±10% | 1kHz | 40 | 796kHz | 70mA | 14.5Ω | 2.7MHz |
| LQH43MN681J03□ | 680μH ±5% | 1kHz | 40 | 796kHz | 65mA | 17.0Ω | 2.5MHz |
| LQH43MN681K03□ | 680μH ±10% | 1kHz | 40 | 796kHz | 65mA | 17.0Ω | 2.5MHz |
| LQH43MN821J03□ | 820μH ±5% | 1kHz | 40 | 796kHz | 60mA | 20.5Ω | 2.2MHz |
| LQH43MN821K03□ | 820μH ±10% | 1kHz | 40 | 796kHz | 60mA | 20.5Ω | 2.2MHz |
| LQH43MN102J03□ | 1000μH ±5% | 1kHz | 40 | 252kHz | 50mA | 25.0Ω | 2.0MHz |
| LQH43MN102K03□ | 1000μH ±10% | 1kHz | 40 | 252kHz | 50mA | 25.0Ω | 2.0MHz |
| LQH43MN122J03□ | 1200μH ±5% | 1kHz | 40 | 252kHz | 45mA | 30.0Ω | 1.8MHz |
| LQH43MN122K03□ | 1200μH ±10% | 1kHz | 40 | 252kHz | 45mA | 30.0Ω | 1.8MHz |
| LQH43MN152J03□ | 1500μH ±5% | 1kHz | 40 | 252kHz | 40mA | 37.0Ω | 1.6MHz |
| LQH43MN152K03□ | 1500μH ±10% | 1kHz | 40 | 252kHz | 40mA | 37.0Ω | 1.6MHz |

Operating temp. range: -40 to 85°C

Class of Magnetic Shield: No Shield

Only for reflow soldering

*S.R.F.: Self Resonant Frequency

When rated current is applied to the products, self-temperature rise shall be limited to 20°C max and inductance will be within ±10% of initial inductance value.

Inductance-Frequency Characteristics (Typ.)



Q-Frequency Characteristics (Typ.)



LQH43NN_03 Series 1812 (4532) inch (mm)



| Packaging Code | Packaging | Minimum Quantity |
|----------------|------------------------|------------------|
| K | ø330mm Embossed Taping | 2500 |
| L | ø180mm Embossed Taping | 500 |

| Part Number (□: packaging code) | Inductance | Inductance Test Frequency | Q (min.) | Q Test Frequency | Rated Current | Max. of DC Resistance | S.R.F.* (min.) |
|------------------------------------|------------|------------------------------|----------|------------------|---------------|-----------------------|----------------|
| LQH43NN1R0M03□ | 1.0μH ±20% | 1MHz | 20 | 1MHz | 500mA | 0.20Ω | 120MHz |
| LQH43NN1R2M03□ | 1.2μH ±20% | 1MHz | 20 | 1MHz | 500mA | 0.20Ω | 100MHz |
| LQH43NN1R5M03□ | 1.5μH ±20% | 1MHz | 20 | 1MHz | 500mA | 0.30Ω | 85MHz |
| LQH43NN1R8M03□ | 1.8μH ±20% | 1MHz | 20 | 1MHz | 500mA | 0.30Ω | 75MHz |
| LQH43NN2R2M03□ | 2.2μH ±20% | 1MHz | 20 | 1MHz | 500mA | 0.30Ω | 62MHz |
| LQH43NN2R7M03□ | 2.7μH ±20% | 1MHz | 20 | 1MHz | 500mA | 0.32Ω | 53MHz |
| LQH43NN3R3M03□ | 3.3μH ±20% | 1MHz | 20 | 1MHz | 500mA | 0.35Ω | 47MHz |
| LQH43NN3R9M03□ | 3.9μH ±20% | 1MHz | 20 | 1MHz | 500mA | 0.38Ω | 41MHz |
| LQH43NN4R7K03□ | 4.7μH ±10% | 1MHz | 30 | 1MHz | 500mA | 0.40Ω | 38MHz |
| LQH43NN4R7M03□ | 4.7μH ±20% | 1MHz | 30 | 1MHz | 500mA | 0.40Ω | 38MHz |
| LQH43NN5R6K03□ | 5.6μH ±10% | 1MHz | 30 | 1MHz | 500mA | 0.47Ω | 33MHz |
| LQH43NN5R6M03□ | 5.6μH ±20% | 1MHz | 30 | 1MHz | 500mA | 0.47Ω | 33MHz |
| LQH43NN6R8K03□ | 6.8μH ±10% | 1MHz | 30 | 1MHz | 450mA | 0.50Ω | 31MHz |
| LQH43NN6R8M03□ | 6.8μH ±20% | 1MHz | 30 | 1MHz | 450mA | 0.50Ω | 31MHz |
| LQH43NN8R2K03□ | 8.2μH ±10% | 1MHz | 30 | 1MHz | 450mA | 0.56Ω | 27MHz |
| LQH43NN8R2M03□ | 8.2μH ±20% | 1MHz | 30 | 1MHz | 450mA | 0.56Ω | 27MHz |
| LQH43NN100J03□ | 10μH ±5% | 1MHz | 35 | 1MHz | 400mA | 0.56Ω | 23MHz |
| LQH43NN100K03□ | 10μH ±10% | 1MHz | 35 | 1MHz | 400mA | 0.56Ω | 23MHz |
| LQH43NN120J03□ | 12μH ±5% | 1MHz | 35 | 1MHz | 380mA | 0.62Ω | 21MHz |
| LQH43NN120K03□ | 12μH ±10% | 1MHz | 35 | 1MHz | 380mA | 0.62Ω | 21MHz |
| LQH43NN150J03□ | 15μH ±5% | 1MHz | 35 | 1MHz | 360mA | 0.73Ω | 19MHz |
| LQH43NN150K03□ | 15μH ±10% | 1MHz | 35 | 1MHz | 360mA | 0.73Ω | 19MHz |
| LQH43NN180J03□ | 18μH ±5% | 1MHz | 35 | 1MHz | 340mA | 0.82Ω | 17MHz |
| LQH43NN180K03□ | 18μH ±10% | 1MHz | 35 | 1MHz | 340mA | 0.82Ω | 17MHz |
| LQH43NN220J03□ | 22μH ±5% | 1MHz | 35 | 1MHz | 320mA | 0.94Ω | 15MHz |
| LQH43NN220K03□ | 22μH ±10% | 1MHz | 35 | 1MHz | 320mA | 0.94Ω | 15MHz |
| LQH43NN270J03□ | 27μH ±5% | 1MHz | 35 | 1MHz | 300mA | 1.1Ω | 14MHz |
| LQH43NN270K03□ | 27μH ±10% | 1MHz | 35 | 1MHz | 300mA | 1.1Ω | 14MHz |
| LQH43NN330J03□ | 33μH ±5% | 1MHz | 35 | 1MHz | 270mA | 1.2Ω | 12MHz |
| LQH43NN330K03□ | 33μH ±10% | 1MHz | 35 | 1MHz | 270mA | 1.2Ω | 12MHz |
| LQH43NN390J03□ | 39μH ±5% | 1MHz | 35 | 1MHz | 240mA | 1.4Ω | 11MHz |
| LQH43NN390K03□ | 39μH ±10% | 1MHz | 35 | 1MHz | 240mA | 1.4Ω | 11MHz |
| LQH43NN470J03□ | 47μH ±5% | 1MHz | 35 | 1MHz | 220mA | 1.5Ω | 10MHz |
| LQH43NN470K03□ | 47μH ±10% | 1MHz | 35 | 1MHz | 220mA | 1.5Ω | 10MHz |
| LQH43NN560J03□ | 56μH ±5% | 1MHz | 35 | 1MHz | 200mA | 1.7Ω | 9.3MHz |
| LQH43NN560K03□ | 56μH ±10% | 1MHz | 35 | 1MHz | 200mA | 1.7Ω | 9.3MHz |
| LQH43NN680J03□ | 68μH ±5% | 1MHz | 35 | 1MHz | 180mA | 1.9Ω | 8.4MHz |
| LQH43NN680K03□ | 68μH ±10% | 1MHz | 35 | 1MHz | 180mA | 1.9Ω | 8.4MHz |
| LQH43NN820J03□ | 82μH ±5% | 1MHz | 35 | 1MHz | 170mA | 2.2Ω | 7.5MHz |

Operating temp. range: -40 to 105°C

Class of Magnetic Shield: No Shield

Only for reflow soldering

*S.R.F.: Self Resonant Frequency

When rated current is applied to the products, self-temperature rise shall be limited to 20°C max and inductance will be within ±10% of initial inductance value.

Continued on the following page. ↗

Continued from the preceding page. ↘

| Part Number (□: packaging code) | Inductance | Inductance Test Frequency | Q (min.) | Q Test Frequency | Rated Current | Max. of DC Resistance | S.R.F.* (min.) |
|------------------------------------|-------------|------------------------------|----------|------------------|---------------|-----------------------|----------------|
| LQH43NN820K03□ | 82μH ±10% | 1MHz | 35 | 1MHz | 170mA | 2.2Ω | 7.5MHz |
| LQH43NN101J03□ | 100μH ±5% | 1MHz | 40 | 796kHz | 160mA | 2.5Ω | 6.8MHz |
| LQH43NN101K03□ | 100μH ±10% | 1MHz | 40 | 796kHz | 160mA | 2.5Ω | 6.8MHz |
| LQH43NN121J03□ | 120μH ±5% | 1MHz | 40 | 796kHz | 150mA | 3.0Ω | 6.2MHz |
| LQH43NN121K03□ | 120μH ±10% | 1MHz | 40 | 796kHz | 150mA | 3.0Ω | 6.2MHz |
| LQH43NN151J03□ | 150μH ±5% | 1MHz | 40 | 796kHz | 130mA | 3.7Ω | 5.5MHz |
| LQH43NN151K03□ | 150μH ±10% | 1MHz | 40 | 796kHz | 130mA | 3.7Ω | 5.5MHz |
| LQH43NN181J03□ | 180μH ±5% | 1MHz | 40 | 796kHz | 120mA | 4.5Ω | 5.0MHz |
| LQH43NN181K03□ | 180μH ±10% | 1MHz | 40 | 796kHz | 120mA | 4.5Ω | 5.0MHz |
| LQH43NN221J03□ | 220μH ±5% | 1MHz | 40 | 796kHz | 110mA | 5.4Ω | 4.5MHz |
| LQH43NN221K03□ | 220μH ±10% | 1MHz | 40 | 796kHz | 110mA | 5.4Ω | 4.5MHz |
| LQH43NN271J03□ | 270μH ±5% | 1MHz | 40 | 796kHz | 100mA | 6.8Ω | 4.0MHz |
| LQH43NN271K03□ | 270μH ±10% | 1MHz | 40 | 796kHz | 100mA | 6.8Ω | 4.0MHz |
| LQH43NN331J03□ | 330μH ±5% | 1MHz | 40 | 796kHz | 95mA | 8.2Ω | 3.6MHz |
| LQH43NN331K03□ | 330μH ±10% | 1MHz | 40 | 796kHz | 95mA | 8.2Ω | 3.6MHz |
| LQH43NN391J03□ | 390μH ±5% | 1MHz | 40 | 796kHz | 90mA | 9.7Ω | 3.3MHz |
| LQH43NN391K03□ | 390μH ±10% | 1MHz | 40 | 796kHz | 90mA | 9.7Ω | 3.3MHz |
| LQH43NN471J03□ | 470μH ±5% | 1kHz | 40 | 796kHz | 80mA | 11.8Ω | 3.0MHz |
| LQH43NN471K03□ | 470μH ±10% | 1kHz | 40 | 796kHz | 80mA | 11.8Ω | 3.0MHz |
| LQH43NN561J03□ | 560μH ±5% | 1kHz | 40 | 796kHz | 70mA | 14.5Ω | 2.7MHz |
| LQH43NN561K03□ | 560μH ±10% | 1kHz | 40 | 796kHz | 70mA | 14.5Ω | 2.7MHz |
| LQH43NN681J03□ | 680μH ±5% | 1kHz | 40 | 796kHz | 65mA | 17.0Ω | 2.5MHz |
| LQH43NN681K03□ | 680μH ±10% | 1kHz | 40 | 796kHz | 65mA | 17.0Ω | 2.5MHz |
| LQH43NN821J03□ | 820μH ±5% | 1kHz | 40 | 796kHz | 60mA | 20.5Ω | 2.2MHz |
| LQH43NN821K03□ | 820μH ±10% | 1kHz | 40 | 796kHz | 60mA | 20.5Ω | 2.2MHz |
| LQH43NN102J03□ | 1000μH ±5% | 1kHz | 40 | 252kHz | 50mA | 25.0Ω | 2.0MHz |
| LQH43NN102K03□ | 1000μH ±10% | 1kHz | 40 | 252kHz | 50mA | 25.0Ω | 2.0MHz |
| LQH43NN122J03□ | 1200μH ±5% | 1kHz | 40 | 252kHz | 45mA | 30.0Ω | 1.8MHz |
| LQH43NN122K03□ | 1200μH ±10% | 1kHz | 40 | 252kHz | 45mA | 30.0Ω | 1.8MHz |
| LQH43NN152J03□ | 1500μH ±5% | 1kHz | 40 | 252kHz | 40mA | 37.0Ω | 1.6MHz |
| LQH43NN152K03□ | 1500μH ±10% | 1kHz | 40 | 252kHz | 40mA | 37.0Ω | 1.6MHz |
| LQH43NN182J03□ | 1800μH ±5% | 1kHz | 40 | 252kHz | 35mA | 45.0Ω | 1.5MHz |
| LQH43NN182K03□ | 1800μH ±10% | 1kHz | 40 | 252kHz | 35mA | 45.0Ω | 1.5MHz |
| LQH43NN222J03□ | 2200μH ±5% | 1kHz | 40 | 252kHz | 30mA | 50.0Ω | 1.3MHz |
| LQH43NN222K03□ | 2200μH ±10% | 1kHz | 40 | 252kHz | 30mA | 50.0Ω | 1.3MHz |
| LQH43NN242J03□ | 2400μH ±5% | 1kHz | 40 | 252kHz | 25mA | 53Ω | 1.2MHz |
| LQH43NN242K03□ | 2400μH ±10% | 1kHz | 40 | 252kHz | 25mA | 53Ω | 1.2MHz |

Operating temp. range: -40 to 105°C

Class of Magnetic Shield: No Shield

Only for reflow soldering

*S.R.F.: Self Resonant Frequency

When rated current is applied to the products, self-temperature rise shall be limited to 20°C max and inductance will be within ±10% of initial inductance value.

Inductance-Frequency Characteristics (Typ.)



Q-Frequency Characteristics (Typ.)



Inductors for Power Lines
 Inductors for General Circuits LQH43NN_03
 RF Inductors

LQB15NN_10 Series 0402 (1005) inch (mm)



| Packaging Code | Packaging | Minimum Quantity |
|----------------|---------------------|------------------|
| D | ø180mm Paper Taping | 10000 |
| B | Packing in Bulk | 1000 |

| Part Number (□: packaging code) | Inductance | Inductance Test Frequency | Q (min.) | Q Test Frequency | Rated Current | DC Resistance | S.R.F.* (min.) |
|------------------------------------|------------|---------------------------|----------|------------------|---------------|---------------|----------------|
| LQB15NNR22J10□ | 220nH ±5% | 25MHz | 10 | 25MHz | 380mA | 0.35Ω±25% | 80MHz |
| LQB15NNR22K10□ | 220nH ±10% | 25MHz | 10 | 25MHz | 380mA | 0.35Ω±25% | 80MHz |
| LQB15NNR22M10□ | 220nH ±20% | 25MHz | 10 | 25MHz | 380mA | 0.35Ω±25% | 80MHz |
| LQB15NNR27J10□ | 270nH ±5% | 25MHz | 10 | 25MHz | 330mA | 0.41Ω±25% | 80MHz |
| LQB15NNR27K10□ | 270nH ±10% | 25MHz | 10 | 25MHz | 330mA | 0.41Ω±25% | 80MHz |
| LQB15NNR27M10□ | 270nH ±20% | 25MHz | 10 | 25MHz | 330mA | 0.41Ω±25% | 80MHz |
| LQB15NNR33J10□ | 330nH ±5% | 25MHz | 10 | 25MHz | 300mA | 0.48Ω±25% | 80MHz |
| LQB15NNR33K10□ | 330nH ±10% | 25MHz | 10 | 25MHz | 300mA | 0.48Ω±25% | 80MHz |
| LQB15NNR33M10□ | 330nH ±20% | 25MHz | 10 | 25MHz | 300mA | 0.48Ω±25% | 80MHz |
| LQB15NNR39J10□ | 390nH ±5% | 25MHz | 10 | 25MHz | 300mA | 0.54Ω±25% | 80MHz |
| LQB15NNR39K10□ | 390nH ±10% | 25MHz | 10 | 25MHz | 300mA | 0.54Ω±25% | 80MHz |
| LQB15NNR39M10□ | 390nH ±20% | 25MHz | 10 | 25MHz | 300mA | 0.54Ω±25% | 80MHz |
| LQB15NNR47J10□ | 470nH ±5% | 25MHz | 10 | 25MHz | 300mA | 0.64Ω±25% | 80MHz |
| LQB15NNR47K10□ | 470nH ±10% | 25MHz | 10 | 25MHz | 300mA | 0.64Ω±25% | 80MHz |
| LQB15NNR47M10□ | 470nH ±20% | 25MHz | 10 | 25MHz | 300mA | 0.64Ω±25% | 80MHz |
| LQB15NNR56J10□ | 560nH ±5% | 25MHz | 10 | 25MHz | 300mA | 0.73Ω±25% | 80MHz |
| LQB15NNR56K10□ | 560nH ±10% | 25MHz | 10 | 25MHz | 300mA | 0.73Ω±25% | 80MHz |
| LQB15NNR56M10□ | 560nH ±20% | 25MHz | 10 | 25MHz | 300mA | 0.73Ω±25% | 80MHz |

Operating temp. range: -55 to 125°C

Class of Magnetic Shield: Ferrite Core

Only for reflow soldering

*S.R.F.: Self Resonant Frequency

When rated current is applied to the products, self-generation of heat will rise to 25°C or less.

Inductance-Frequency Characteristics (Typ.)



— LQB15NNR22M10 220nH - - - LQB15NNR39M10 390nH
 — LQB15NNR56M10 560nH

Q-Frequency Characteristics (Typ.)



— LQB15NNR22M10 220nH - - - LQB15NNR39M10 390nH
 — LQB15NNR56M10 560nH

LQB18NN_10 Series 0603 (1608) inch (mm)



| Packaging Code | Packaging | Minimum Quantity |
|----------------|---------------------|------------------|
| D | ø180mm Paper Taping | 4000 |
| B | Packing in Bulk | 1000 |

| Part Number (□: packaging code) | Inductance | Inductance Test Frequency | Q (min.) | Q Test Frequency | Rated Current | Max. of DC Resistance | S.R.F.* (min.) |
|------------------------------------|------------|---------------------------|----------|------------------|---------------|-----------------------|----------------|
| LQB18NNR22J10□ | 220nH ±5% | 25MHz | 25 | 25MHz | 450mA | 0.37Ω | 80MHz |
| LQB18NNR22K10□ | 220nH ±10% | 25MHz | 25 | 25MHz | 450mA | 0.37Ω | 80MHz |
| LQB18NNR22M10□ | 220nH ±20% | 25MHz | 25 | 25MHz | 450mA | 0.37Ω | 80MHz |
| LQB18NNR22N10□ | 220nH ±30% | 25MHz | 25 | 25MHz | 450mA | 0.37Ω | 80MHz |
| LQB18NNR27J10□ | 270nH ±5% | 25MHz | 25 | 25MHz | 450mA | 0.45Ω | 80MHz |
| LQB18NNR27K10□ | 270nH ±10% | 25MHz | 25 | 25MHz | 450mA | 0.45Ω | 80MHz |
| LQB18NNR27M10□ | 270nH ±20% | 25MHz | 25 | 25MHz | 450mA | 0.45Ω | 80MHz |
| LQB18NNR27N10□ | 270nH ±30% | 25MHz | 25 | 25MHz | 450mA | 0.45Ω | 80MHz |
| LQB18NNR33J10□ | 330nH ±5% | 25MHz | 25 | 25MHz | 450mA | 0.45Ω | 80MHz |
| LQB18NNR33K10□ | 330nH ±10% | 25MHz | 25 | 25MHz | 450mA | 0.45Ω | 80MHz |
| LQB18NNR33M10□ | 330nH ±20% | 25MHz | 25 | 25MHz | 450mA | 0.45Ω | 80MHz |
| LQB18NNR33N10□ | 330nH ±30% | 25MHz | 25 | 25MHz | 450mA | 0.45Ω | 80MHz |
| LQB18NNR39J10□ | 390nH ±5% | 25MHz | 25 | 25MHz | 450mA | 0.58Ω | 80MHz |
| LQB18NNR39K10□ | 390nH ±10% | 25MHz | 25 | 25MHz | 450mA | 0.58Ω | 80MHz |
| LQB18NNR39M10□ | 390nH ±20% | 25MHz | 25 | 25MHz | 450mA | 0.58Ω | 80MHz |
| LQB18NNR39N10□ | 390nH ±30% | 25MHz | 25 | 25MHz | 450mA | 0.58Ω | 80MHz |
| LQB18NNR47J10□ | 470nH ±5% | 25MHz | 25 | 25MHz | 400mA | 0.58Ω | 80MHz |
| LQB18NNR47K10□ | 470nH ±10% | 25MHz | 25 | 25MHz | 400mA | 0.58Ω | 80MHz |
| LQB18NNR47M10□ | 470nH ±20% | 25MHz | 25 | 25MHz | 400mA | 0.58Ω | 80MHz |
| LQB18NNR47N10□ | 470nH ±30% | 25MHz | 25 | 25MHz | 400mA | 0.58Ω | 80MHz |
| LQB18NNR56J10□ | 560nH ±5% | 25MHz | 25 | 25MHz | 300mA | 0.85Ω | 80MHz |
| LQB18NNR56K10□ | 560nH ±10% | 25MHz | 25 | 25MHz | 300mA | 0.85Ω | 80MHz |
| LQB18NNR56M10□ | 560nH ±20% | 25MHz | 25 | 25MHz | 300mA | 0.85Ω | 80MHz |
| LQB18NNR56N10□ | 560nH ±30% | 25MHz | 25 | 25MHz | 300mA | 0.85Ω | 80MHz |

Operating temp. range: -55 to 125°C

Class of Magnetic Shield: Ferrite Core

*S.R.F.: Self Resonant Frequency

Inductance-Frequency Characteristics (Typ.)



Q-Frequency Characteristics (Typ.)



LQM18JN_00 Series 0603 (1608) inch (mm)



| Packaging Code | Packaging | Minimum Quantity |
|----------------|---------------------|------------------|
| D | ø180mm Paper Taping | 4000 |
| B | Packing in Bulk | 1000 |

| Part Number (□: packaging code) | Inductance | Inductance Test Frequency | Q (min.) | Q Test Frequency | Rated Current | DC Resistance | S.R.F.* (min.) |
|------------------------------------|------------|---------------------------|----------|------------------|---------------|---------------|----------------|
| LQM18JNR10J00□ | 100nH ±5% | 25MHz | 8 | 25MHz | 650mA | 0.41Ω±25% | 200MHz |
| LQM18JNR12J00□ | 120nH ±5% | 25MHz | 8 | 25MHz | 610mA | 0.47Ω±25% | 150MHz |
| LQM18JNR16J00□ | 160nH ±5% | 25MHz | 8 | 25MHz | 550mA | 0.6Ω±25% | 100MHz |

Operating temp. range: -40 to 85°C

Class of Magnetic Shield: Ferrite Core

*S.R.F.: Self Resonant Frequency

Inductance-Frequency Characteristics (Typ.)



Inductance-Current Characteristics (Typ.)



LQM18NN_00 Series 0603 (1608) inch (mm)



| Packaging Code | Packaging | Minimum Quantity |
|----------------|---------------------|------------------|
| D | ø180mm Paper Taping | 4000 |
| J | ø330mm Paper Taping | 10000 |
| B | Packing in Bulk | 1000 |

Continued on the following page. ↗

Continued from the preceding page. ↘

| Part Number (□: packaging code) | Inductance | Inductance Test Frequency | Q (min.) | Q Test Frequency | Rated Current | Max. of DC Resistance | S.R.F.* (min.) |
|------------------------------------|-------------|------------------------------|----------|------------------|---------------|-----------------------|----------------|
| LQM18NN47NM00□ | 47nH ±20% | 50MHz | 10 | 50MHz | 50mA | 0.30Ω | 260MHz |
| LQM18NN68NM00□ | 68nH ±20% | 50MHz | 10 | 50MHz | 50mA | 0.30Ω | 250MHz |
| LQM18NN82NM00□ | 82nH ±20% | 50MHz | 10 | 50MHz | 50mA | 0.30Ω | 245MHz |
| LQM18NNR10K00□ | 100nH ±10% | 25MHz | 15 | 25MHz | 50mA | 0.50Ω | 240MHz |
| LQM18NNR12K00□ | 120nH ±10% | 25MHz | 15 | 25MHz | 50mA | 0.50Ω | 205MHz |
| LQM18NNR15K00□ | 150nH ±10% | 25MHz | 15 | 25MHz | 50mA | 0.60Ω | 180MHz |
| LQM18NNR18K00□ | 180nH ±10% | 25MHz | 15 | 25MHz | 50mA | 0.60Ω | 165MHz |
| LQM18NNR22K00□ | 220nH ±10% | 25MHz | 15 | 25MHz | 50mA | 0.80Ω | 150MHz |
| LQM18NNR27K00□ | 270nH ±10% | 25MHz | 15 | 25MHz | 50mA | 0.80Ω | 136MHz |
| LQM18NNR33K00□ | 330nH ±10% | 25MHz | 15 | 25MHz | 35mA | 0.85Ω | 125MHz |
| LQM18NNR39K00□ | 390nH ±10% | 25MHz | 15 | 25MHz | 35mA | 1.00Ω | 110MHz |
| LQM18NNR47K00□ | 470nH ±10% | 25MHz | 15 | 25MHz | 35mA | 1.35Ω | 105MHz |
| LQM18NNR56K00□ | 560nH ±10% | 25MHz | 15 | 25MHz | 35mA | 1.55Ω | 95MHz |
| LQM18NNR68K00□ | 680nH ±10% | 25MHz | 15 | 25MHz | 35mA | 1.70Ω | 90MHz |
| LQM18NNR82K00□ | 820nH ±10% | 25MHz | 15 | 25MHz | 35mA | 2.10Ω | 85MHz |
| LQM18NN1R0K00□ | 1000nH ±10% | 10MHz | 35 | 10MHz | 25mA | 0.60Ω | 75MHz |
| LQM18NN1R2K00□ | 1200nH ±10% | 10MHz | 35 | 10MHz | 25mA | 0.80Ω | 65MHz |
| LQM18NN1R5K00□ | 1500nH ±10% | 10MHz | 35 | 10MHz | 25mA | 0.80Ω | 60MHz |
| LQM18NN1R8K00□ | 1800nH ±10% | 10MHz | 35 | 10MHz | 25mA | 0.95Ω | 55MHz |
| LQM18NN2R2K00□ | 2200nH ±10% | 10MHz | 35 | 10MHz | 15mA | 1.15Ω | 50MHz |

Operating temp. range: -40 to 85°C
 Class of Magnetic Shield: Ferrite Core
 *S.R.F.: Self Resonant Frequency

Inductance-Frequency Characteristics (Typ.)



Q-Frequency Characteristics (Typ.)



LQM21NN_10 Series 0805 (2012) inch (mm)



| Dimension of t | Inductance: 0.1 to 2.2μH | 0.85±0.2 |
|----------------|--------------------------|--------------------------|
| | | Inductance: 2.7 to 4.7μH |

(Inductance: 0.10μH to 2.2μH)

| Packaging Code | Packaging | Minimum Quantity |
|----------------|---------------------|------------------|
| D | ø180mm Paper Taping | 4000 |
| J | ø330mm Paper Taping | 10000 |
| B | Packing in Bulk | 1000 |

(Inductance: 2.7μH to 4.7μH)

| Packaging Code | Packaging | Minimum Quantity |
|----------------|------------------------|------------------|
| K | ø330mm Embossed Taping | 10000 |
| L | ø180mm Embossed Taping | 3000 |
| B | Packing in Bulk | 1000 |

Continued on the following page. ↗

Continued from the preceding page. ↘

| Part Number (□: packaging code) | Inductance | Inductance Test Frequency | Q (min.) | Q Test Frequency | Rated Current | Max. of DC Resistance | S.R.F.* (min.) |
|------------------------------------|-------------|---------------------------|----------|------------------|---------------|-----------------------|----------------|
| LQM21NNR10K10□ | 0.10μH ±10% | 25MHz | 20 | 25MHz | 250mA | 0.26Ω | 340MHz |
| LQM21NNR12K10□ | 0.12μH ±10% | 25MHz | 20 | 25MHz | 250mA | 0.29Ω | 310MHz |
| LQM21NNR15K10□ | 0.15μH ±10% | 25MHz | 20 | 25MHz | 250mA | 0.32Ω | 270MHz |
| LQM21NNR18K10□ | 0.18μH ±10% | 25MHz | 20 | 25MHz | 250mA | 0.35Ω | 250MHz |
| LQM21NNR22K10□ | 0.22μH ±10% | 25MHz | 20 | 25MHz | 250mA | 0.38Ω | 220MHz |
| LQM21NNR27K10□ | 0.27μH ±10% | 25MHz | 20 | 25MHz | 250mA | 0.42Ω | 200MHz |
| LQM21NNR33K10□ | 0.33μH ±10% | 25MHz | 20 | 25MHz | 250mA | 0.48Ω | 180MHz |
| LQM21NNR39K10□ | 0.39μH ±10% | 25MHz | 25 | 25MHz | 200mA | 0.53Ω | 165MHz |
| LQM21NNR47K10□ | 0.47μH ±10% | 25MHz | 25 | 25MHz | 200mA | 0.57Ω | 150MHz |
| LQM21NNR56K10□ | 0.56μH ±10% | 25MHz | 25 | 25MHz | 150mA | 0.63Ω | 140MHz |
| LQM21NNR68K10□ | 0.68μH ±10% | 25MHz | 25 | 25MHz | 150mA | 0.72Ω | 125MHz |
| LQM21NNR82K10□ | 0.82μH ±10% | 25MHz | 25 | 25MHz | 150mA | 0.81Ω | 115MHz |
| LQM21NN1R0K10□ | 1.0μH ±10% | 10MHz | 45 | 10MHz | 50mA | 0.40Ω | 107MHz |
| LQM21NN1R2K10□ | 1.2μH ±10% | 10MHz | 45 | 10MHz | 50mA | 0.47Ω | 97MHz |
| LQM21NN1R5K10□ | 1.5μH ±10% | 10MHz | 45 | 10MHz | 50mA | 0.50Ω | 87MHz |
| LQM21NN1R8K10□ | 1.8μH ±10% | 10MHz | 45 | 10MHz | 50mA | 0.57Ω | 80MHz |
| LQM21NN2R2K10□ | 2.2μH ±10% | 10MHz | 45 | 10MHz | 30mA | 0.63Ω | 71MHz |
| LQM21NN2R7K10□ | 2.7μH ±10% | 10MHz | 45 | 10MHz | 30mA | 0.69Ω | 66MHz |
| LQM21NN3R3K10□ | 3.3μH ±10% | 10MHz | 45 | 10MHz | 30mA | 0.80Ω | 59MHz |
| LQM21NN3R9K10□ | 3.9μH ±10% | 10MHz | 45 | 10MHz | 30mA | 0.89Ω | 53MHz |
| LQM21NN4R7K10□ | 4.7μH ±10% | 10MHz | 45 | 10MHz | 30mA | 1.00Ω | 47MHz |

Operating temp. range: -40 to 85°C
 Class of Magnetic Shield: Ferrite Core
 *S.R.F.: Self Resonant Frequency

Inductance-Frequency Characteristics (Typ.)



Q-Frequency Characteristics (Typ.)



Inductors for General Circuits ⚠️Caution/Notice

⚠️Caution

Rating

1. About the Rated Current

Do not use products beyond the rated current as this may create excessive heat and deteriorate the insulation resistance.

Be sure to provide an appropriate fail-safe function on your product to prevent a second damage that may be caused by the abnormal function or the failure of our product.

2. About Excessive Surge Current

Surge current (pulse current or rush current) greater than the specified rated current applied to the product may cause a critical failure, such as an open circuit or burnout caused by excessive temperature rise.

Please contact us in advance if applying a surge current.

Notice

Storage and Operating Condition

<Operating Environment>

Do not use products in a chemical atmosphere such as chlorine gas, acid or sulfide gas.

<Storage Requirements>

1. Storage Period

The LQB series and LQM series should be used within 6 months; the other products should be used within 12 months.

Check solderability if this period is exceeded.

2. Storage Conditions

(1) Store products in a warehouse in compliance with the following conditions:

Temperature: -10 to +40 degrees C.

Humidity: 15 to 85% (relative humidity)

Do not subject products to rapid changes in temperature and humidity.

Do not store them in a chemical atmosphere such as one containing sulfurous acid gas, alkaline gas or acid. This will prevent electrode oxidation, which causes poor solderability and possible corrosion of inductors.

(2) Do not store products in bulk packaging to prevent collision among inductors, which causes core chipping and wire breakage.

(3) Store products on pallets to protect from humidity, dust, etc.

(4) Avoid heat shock, vibration, direct sunlight, etc.

Handling

This item is designed to have sufficient strength, but handle with care to avoid chipping or breaking its ceramic structure.

LQH_M/N series

- To prevent breaking the wire, avoid touching with sharp materials, such as tweezers or the bristles of a cleaning brush, to the wire wound portion of this product.
- To prevent breaking the core, avoid applying excessive mechanical shock to products mounted on the board.

LQW_C series

- To prevent breaking the wire, avoid touching with sharp materials, such as tweezers or other materials such as the bristles of a cleaning brush, to the wire wound portion.
- To prevent breaking the core, avoid applying excessive mechanical shock to products mounted on the board.
- In some mounting machines, when picking up components, a support pin pushes the components up from the bottom of the base tape. In this case, please remove the support pin. The support pin may damage the components and break the wire.

- The product temperature rises about 40°C maximum when the permissible current is applied to LQW15C. Please use caution regarding the temperature of the substrate and air around the part.

LQB series and LQM series

- There is the possibility that magnetism may change the inductance value. Do not use a magnet or tweezers with magnetism when handling products. (The tip of the tweezers should be molded with resin or pottery.)
- When excessive current over the rated current is applied, it may cause the inductance value to change due to magnetism.

<Transportation>

Do not apply excessive vibration or mechanical shock to product.

Continued on the following page. ↗

Inductors for General Circuits ⚠Caution/Notice

Continued from the preceding page. ↘

<Resin Coating>

When coating products with resin, the relatively high resin curing stress may change inductance values.

For exterior coating, select resin carefully so that electrical and mechanical performance of the product is not affected. Prior to use, please evaluate reliability with the product mounted in your application set.

- LQH/LQW series

An open circuit issue may occur by mechanical stress caused by the resin, amount/cured shape of resin, or operating conditions, etc. Some resins containing impurities or chloride may possibly generate chlorine by hydrolysis under some operating conditions, causing corrosion of the inductor wire and leading to an open circuit.

<Handling of a Substrate>

After mounting products on a substrate, do not apply any stress to the product caused by bending or twisting the substrate when cropping the substrate, inserting and removing a connector from the substrate, or tightening a screw to the substrate.

Excessive mechanical stress may cause cracking in the Product.



Measuring Method

Measuring Method of Inductance/Q

1. Residual elements and stray elements of test fixtures can be described by F-parameter as shown in the following:



2. The impedance of products Z_x and measured value Z_m can be described by input/output current/voltage.

$$Z_m = \frac{V_1}{I_1}, \quad Z_x = \frac{V_2}{I_2}$$

3. Thus, the relation between Z_x and Z_m is shown in the following:

$$Z_x = \alpha \frac{Z_m - \beta}{1 - Z_m \Gamma}$$

where, $\alpha = D / A = 1$

$$\beta = B / D = Z_{sm} - (1 - Y_{om} Z_{sm}) Z_{ss}$$

$$\Gamma = C / A = Y_{om}$$

(Z_{sm} : measured impedance of short chip
 Z_{ss} : residual impedance of short chip*
 Y_{om} : measured admittance when opening the fixture)

*Residual inductance of short chip

| Residual Inductance | Series |
|---------------------|--------------|
| 0.556nH | LQW04CA/15CA |
| 0.771nH | LQW18CA |

4. L_x and Q_x should be calculated with the following equation.

$$L_x = \frac{\text{Im}(Z_x)}{2\pi f}, \quad Q_x = \frac{\text{Im}(Z_x)}{\text{Re}(Z_x)}$$

L_x : Inductance of products
 Q_x : Q of products
 f : Measuring frequency

Inductors for General Circuits Soldering and Mounting

1. Standard Land Pattern Dimensions

A high Q value is achieved when the PCB electrode land pattern is designed so that it does not project beyond the products' electrode.

Land Pattern + Solder Resist
 Land Pattern
 Solder Resist
 (in mm)

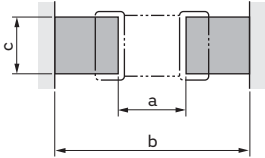
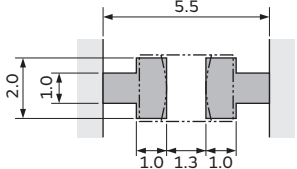
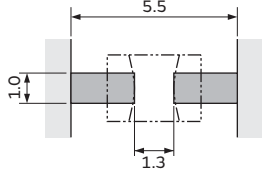
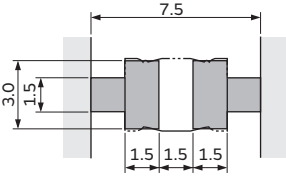
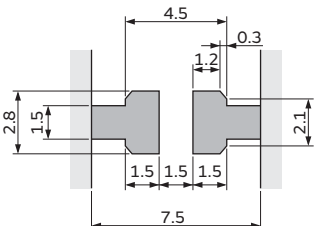
| Series | Standard Land Dimensions | | | | | | | | | | | | | | | | | | | | | | | | | | | | | | | | | | | | | | | | | | | | | | | | | | | |
|---|---|---|------------|--|-------------|--|---|---|---|---------|--------|-----|------------|-----|--------|------|-----|------------|-----|----------|--------|------------|--------|--|-----|------------|-----|--------|--|-----|-----|-----|--------|--|-----|-----|-----|---------|--|------|------|------|---------|--|------|------|------|---------|--|-----|-----|-----|
| LQB15N LQB18N LQM18J/N LQM21N LQH31M LQH44N LQW04CA LQW15CA LQW18CA |  | | | <table border="1" style="width: 100%; border-collapse: collapse;"> <thead> <tr> <th colspan="2" style="background-color: #444; color: white;">Part Number</th> <th style="background-color: #444; color: white;">a</th> <th style="background-color: #444; color: white;">b</th> <th style="background-color: #444; color: white;">c</th> </tr> </thead> <tbody> <tr> <td style="background-color: #444; color: white;">LQB15NN</td> <td style="background-color: #444; color: white;">Reflow</td> <td style="text-align: center;">0.4</td> <td style="text-align: center;">1.2 to 1.4</td> <td style="text-align: center;">0.5</td> </tr> <tr> <td style="background-color: #444; color: white;">LQB18N</td> <td style="background-color: #444; color: white;">Flow</td> <td rowspan="2" style="text-align: center;">0.7</td> <td style="text-align: center;">2.2 to 2.6</td> <td rowspan="2" style="text-align: center;">0.7</td> </tr> <tr> <td style="background-color: #444; color: white;">LQM18J/N</td> <td style="background-color: #444; color: white;">Reflow</td> <td style="text-align: center;">1.8 to 2.0</td> </tr> <tr> <td style="background-color: #444; color: white;">LQM21N</td> <td></td> <td style="text-align: center;">1.2</td> <td style="text-align: center;">3.0 to 4.0</td> <td style="text-align: center;">1.0</td> </tr> <tr> <td style="background-color: #444; color: white;">LQH31M</td> <td></td> <td style="text-align: center;">1.0</td> <td style="text-align: center;">4.5</td> <td style="text-align: center;">1.5</td> </tr> <tr> <td style="background-color: #444; color: white;">LQH44N</td> <td></td> <td style="text-align: center;">1.3</td> <td style="text-align: center;">4.4</td> <td style="text-align: center;">3.0</td> </tr> <tr> <td style="background-color: #444; color: white;">LQW04CA</td> <td></td> <td style="text-align: center;">0.45</td> <td style="text-align: center;">1.05</td> <td style="text-align: center;">0.48</td> </tr> <tr> <td style="background-color: #444; color: white;">LQW15CA</td> <td></td> <td style="text-align: center;">0.45</td> <td style="text-align: center;">1.45</td> <td style="text-align: center;">0.64</td> </tr> <tr> <td style="background-color: #444; color: white;">LQW18CA</td> <td></td> <td style="text-align: center;">0.7</td> <td style="text-align: center;">2.2</td> <td style="text-align: center;">1.0</td> </tr> </tbody> </table> | Part Number | | a | b | c | LQB15NN | Reflow | 0.4 | 1.2 to 1.4 | 0.5 | LQB18N | Flow | 0.7 | 2.2 to 2.6 | 0.7 | LQM18J/N | Reflow | 1.8 to 2.0 | LQM21N | | 1.2 | 3.0 to 4.0 | 1.0 | LQH31M | | 1.0 | 4.5 | 1.5 | LQH44N | | 1.3 | 4.4 | 3.0 | LQW04CA | | 0.45 | 1.05 | 0.48 | LQW15CA | | 0.45 | 1.45 | 0.64 | LQW18CA | | 0.7 | 2.2 | 1.0 |
| Part Number | | a | b | c | | | | | | | | | | | | | | | | | | | | | | | | | | | | | | | | | | | | | | | | | | | | | | | | |
| LQB15NN | Reflow | 0.4 | 1.2 to 1.4 | 0.5 | | | | | | | | | | | | | | | | | | | | | | | | | | | | | | | | | | | | | | | | | | | | | | | | |
| LQB18N | Flow | 0.7 | 2.2 to 2.6 | 0.7 | | | | | | | | | | | | | | | | | | | | | | | | | | | | | | | | | | | | | | | | | | | | | | | | |
| LQM18J/N | Reflow | | 1.8 to 2.0 | | | | | | | | | | | | | | | | | | | | | | | | | | | | | | | | | | | | | | | | | | | | | | | | | |
| LQM21N | | 1.2 | 3.0 to 4.0 | 1.0 | | | | | | | | | | | | | | | | | | | | | | | | | | | | | | | | | | | | | | | | | | | | | | | | |
| LQH31M | | 1.0 | 4.5 | 1.5 | | | | | | | | | | | | | | | | | | | | | | | | | | | | | | | | | | | | | | | | | | | | | | | | |
| LQH44N | | 1.3 | 4.4 | 3.0 | | | | | | | | | | | | | | | | | | | | | | | | | | | | | | | | | | | | | | | | | | | | | | | | |
| LQW04CA | | 0.45 | 1.05 | 0.48 | | | | | | | | | | | | | | | | | | | | | | | | | | | | | | | | | | | | | | | | | | | | | | | | |
| LQW15CA | | 0.45 | 1.45 | 0.64 | | | | | | | | | | | | | | | | | | | | | | | | | | | | | | | | | | | | | | | | | | | | | | | | |
| LQW18CA | | 0.7 | 2.2 | 1.0 | | | | | | | | | | | | | | | | | | | | | | | | | | | | | | | | | | | | | | | | | | | | | | | | |
| LQH32M | Reflow Soldering*  | Flow Soldering  | | | | | | | | | | | | | | | | | | | | | | | | | | | | | | | | | | | | | | | | | | | | | | | | | | |
| | * Applicable to flow soldering. | | | | | | | | | | | | | | | | | | | | | | | | | | | | | | | | | | | | | | | | | | | | | | | | | | | |
| LQH43M |  | | | | | | | | | | | | | | | | | | | | | | | | | | | | | | | | | | | | | | | | | | | | | | | | | | | |
| LQH43N |  | | | | | | | | | | | | | | | | | | | | | | | | | | | | | | | | | | | | | | | | | | | | | | | | | | | |

Attention should be paid to potential magnetic coupling effects when using the Inductor (coil) as a resonator.

2. Standard Soldering Conditions

(1) Soldering method

Apply reflow soldering process except for flow soldering available products.

Please contact Murata regarding other soldering methods.

Solder: Use Sn-3.0Ag-0.5Cu solder.

Flux: Use rosin-based flux, but not strongly acidic flux (with chlorine content exceeding 0.2wt%).

Do not use water-soluble flux.

Please pay attention to solder paste's penetrating in order to avoid short circuit between the lines.

For additional mounting methods, please contact Murata.

Continued on the following page. ↗

Inductors for General Circuits Soldering and Mounting

Continued from the preceding page. ↘

(2) Soldering profile

●Flow Soldering profile



| Series | Pre-heating | | Standard Profile | | | Limit Profile | | |
|--|-------------|------------|------------------|------------|---------------|---------------|------------|---------------|
| | Temp. (T1) | Time. (t1) | Heating | | Cycle of flow | Heating | | Cycle of flow |
| | | | Temp. (T2) | Time. (t2) | | Temp. (T3) | Time. (t1) | |
| LQB18N LQM18J/N LQM21N LQH31M | 150°C | 60s min. | 250°C | 4 to 6s | 2 times max. | 265±3°C | 5s max. | 2 times max. |
| LQH32M | 150°C | 60s min. | 250°C | 4 to 6s | 2 times max. | 265±3°C | 5s max. | 1 time |

●Reflow Soldering profile



| Series | Standard Profile | | | | Limit Profile | | | |
|---|------------------|------------|-----------------------|-----------------|---------------|------------|-----------------------|-----------------|
| | Heating | | Peak temperature (T2) | Cycle of reflow | Heating | | Peak temperature (T4) | Cycle of reflow |
| | Temp. (T1) | Time. (t1) | | | Temp. (T3) | Time. (t2) | | |
| LQB15N LQB18N LQM18J/N LQM21N LQH31M LQH43N LQH44N LQW04CA LQW15CA LQW18CA | 220°C | 30 to 60s | 245±3°C | 2 times max. | 230°C | 60s max. | 260°C/10s | 2 times max. |
| LQH32M LQH43M | 220°C | 30 to 60s | 245±3°C | 2 times max. | 230°C | 60s max. | 260°C/10s | 1 time |

(3) Reworking with a Soldering Iron

*Except for LQW04CA

Preheating at 150°C for 1 minute is required. Do not directly touch the ceramic element with the tip of the soldering iron. The reworking soldering conditions are as follows:

Soldering iron power output: 80W max.

Temperature of soldering iron tip: 350°C

Diameter of soldering iron end: 3.0mm max.

Soldering time: within 3 s

Please keep the fix time with the soldering iron within 1 time for each terminal.

Continued on the following page. ↗

Inductors for General Circuits Soldering and Mounting

Continued from the preceding page. ↘

3. Mounting Instructions

(1) Land Pattern Dimensions

Large land design tend to reduce Q value of the product. Also, large protruding land areas (bordered by lines having the dimensions "c" and "d" shown) cause floating and electrode leaching.



(2) Land Pattern Designing (LQH series)

Please follow the recommended patterns. Otherwise, their performance, which includes electrical performance or solderability, may be affected, or result in "position shift" in the soldering process.

(3) Magnetic Coupling

Since some products are constructed like an open magnetic circuit, narrow spacing between inductors (coils) may cause magnetic coupling.



(4) PCB Warping

The PCB should be designed so that products are not subjected to mechanical stress caused by warping the board.



(5) Amount of Solder Paste

Excessive solder causes electrode corrosion, while insufficient solder causes low electrode bonding strength. Adjust the amount of solder paste as shown on the right so that the correct amount is applied.

Guideline of solder paste thickness

- LQM/LQW18CA: 100 to 150 μ m
- LQB: 100 to 200 μ m
- LQH: 200 to 300 μ m
- LQW04CA: 80 to 100 μ m
- LQW15CA: 50 to 100 μ m



Continued on the following page. ↗

Inductors for General Circuits Soldering and Mounting

Continued from the preceding page. ↘

4. Cleaning

The following conditions should be observed when cleaning products:

- (1) Cleaning Temperature: 60°C max. (40°C max. for alcohol cleaning agents)
- (2) Ultrasonic
Output: 20W/l max.
Duration: 5 minutes max.
Frequency: 28 to 40kHz
Care should be taken not to cause resonance of the PCB and mounted products.
- (3) Cleaning agent
The following cleaning agents have been tested on individual components. Evaluation in complete assembly should be done prior to production.
 - (a) Alcohol cleaning agents
Isopropyl alcohol (IPA)
 - (b) Aqueous cleaning agents
Pine Alpha ST-100S

- (4) Ensure that flux residue is completely removed. Component should be thoroughly dried after aqueous agents have been removed with deionized water.

For additional cleaning methods, please contact Murata.

Inductors for General Circuits Packaging

Minimum Quantity and 8mm Width Taping Dimensions



The dimension of the cavity of embossed tape is measured at the bottom side.

Paper Tape

| Part Number | Dimensions | | Total Thickness of Tape | Packaging Code (Minimum Qty. (pcs.)) | | |
|-----------------------|------------|------|-------------------------|--------------------------------------|-------------|-------------|
| | a | b | | c | ø180mm reel | ø330mm reel |
| LQB18N | 1.05 | 1.85 | 1.1 max. | D (4000) | — | B (1000) |
| LQM21N (0.1 to 2.2μH) | 1.45 | 2.25 | 1.1 max. | D (4000) | J (10000) | B (1000) |
| LQM18J | 1.05 | 1.85 | 0.85 max. | D (4000) | — | B (1000) |
| LQM18N | 1.05 | 1.85 | 1.1 max. | D (4000) | J (10000) | B (1000) |

Embossed Tape

| Part Number | Dimensions | | Depth of Cavity | Packaging Code (Minimum Qty. (pcs.)) | | |
|-----------------------|------------|------|-----------------|--------------------------------------|-------------|-------------|
| | a | b | | c | ø180mm reel | ø330mm reel |
| LQM21N (2.7 to 4.7μH) | 1.45 | 2.25 | 1.3 | L (3000) | K (10000) | B (1000) |
| LQH31M | 1.9 | 3.6 | 2.0 | L (2000) | K (7500) | — |
| LQH32M | 2.9 | 3.6 | 2.1 | L (2000) | K (7500) | — |

(in mm)

Minimum Quantity and 8mm Width Taping Dimensions



Paper Tape

| Part Number | Dimensions | | Total Thickness of Tape | Packaging Code (Minimum Qty. (pcs.)) | | |
|-------------|------------|------|-------------------------|--------------------------------------|-------------|-------------|
| | a | b | | c | ø180mm reel | ø330mm reel |
| LQB15N | 0.65 | 1.15 | 0.8 max. | D (10000) | — | B (1000) |
| LQW04CA | 0.59 | 1.01 | 0.71 max. | D (10000) | — | B (500) |
| LQW15CA | 0.66 | 1.22 | 0.9 max. | D (10000) | — | B (500) |
| LQW18CA | 1.0 | 1.8 | 1.1 max. | D (4000) | J (10000) | B (500) |

(in mm)

Continued on the following page. ↗

Inductors for General Circuits Packaging

Continued from the preceding page. ↘

Minimum Quantity and 12mm Width Embossed Taping Dimensions



The dimension of the cavity of embossed tape is measured at the bottom side.

Embossed Tape

| Part Number | Dimensions (*c: Depth of Cavity) | | | | Packaging Code (Minimum Qty. (pcs.)) | | |
|-------------|----------------------------------|-----|-----|-----|--------------------------------------|-------------|------|
| | a | b | c | d | ø180mm reel | ø330mm reel | Bulk |
| LQH43M | 3.6 | 4.9 | 2.7 | 0.3 | L (500) | K (2500) | — |
| LQH43N | 3.6 | 4.9 | 2.7 | 0.3 | L (500) | K (2500) | — |
| LQH44N | 4.3 | 4.3 | 4.7 | 0.4 | L (250) | K (1500) | — |

(in mm)

RF Inductors

| | |
|------------------------------|------|
| Part Numbering | p182 |
| Product Detail | p183 |
| ⚠Caution/Notice | p263 |
| Soldering and Mounting | p265 |
| Packaging | p269 |

● Part Numbering

RF Inductors

(Part Number)



① Product ID

| Product ID | |
|------------|-----------------------------|
| LQ | Chip Inductors (Chip Coils) |

② Structure

| Code | Structure |
|------|--|
| G | Multilayer Type (Air-core Inductors (Coils)) |
| H | Wire Wound Type (Ferrite Core) |
| P | Film Type |
| W | Wire Wound Type (Air-core Inductors (Coils)) Wire Wound Type (Ferrite Core) |

② Dimensions (LxW)

| Code | Nominal Dimensions (LxW) | Size Code (in inch) |
|------|--------------------------|---------------------|
| 02 | 0.4×0.2mm | 01005 |
| 03 | 0.6×0.3mm | 0201 |
| 04 | 0.8×0.4mm | 03015 |
| 15 | 1.0×0.5mm | 0402 |
| 18 | 1.6×0.8mm | 0603 |
| 21 | 2.0×1.25mm | 0805 |
| 2B | 2.0×1.5mm | 0805 |
| 2U | 2.5×2.0mm | 1008 |
| 31 | 3.2×1.6mm | 1206 |

④ Applications and Characteristics

| Code | Series | Applications and Characteristics |
|------|--------|---------------------------------------|
| H | LQG | Multilayer Air-core Inductors (Coils) |
| | LQP | Film Type (High Q Type) |
| M | LQP | Film Type |
| P | | Film Type (For Large Current) |
| T | | Film Type (Low DC Resistance Type) |
| A | LQW | High Q Type (UHF-SHF) |
| H | | High Q Type (VHF-UHF) |
| H | LQH | for High-frequency Resonant Circuit |

⑤ Category

| Code | Category | |
|------|----------|----------------------|
| G/N | General | Standard Type |
| S | | |
| Q | | High Q Type |
| W | | Specialty Dimensions |

⑥ Inductance

Expressed by three-digit alphanumerics. The unit is micro-henry (μH). The first and second figures are significant digits, and the third figure expresses the number of zeros that follow the two figures. If there is a decimal point, it is expressed by the capital letter "R." In this case, all figures are significant digits. If inductance is less than 0.1μH, the inductance code is expressed by a combination of two figures and the capital letter "N," and the unit of inductance is nano-henry (nH). The capital letter "N" indicates the unit of "nH," and also expresses a decimal point. In this case, all figures are significant digits. For those products whose inductance values are specified using three designated digits, these values may be indicated using the closest two digits instead.

⑦ Inductance Tolerance

| Code | Inductance Tolerance |
|------|----------------------|
| B | ±0.1nH |
| C | ±0.2nH |
| D | ±0.5nH |
| F | ±1% |
| G | ±2% |
| H | ±3% |
| J | ±5% |
| K | ±10% |
| M | ±20% |
| S | ±0.3nH |
| W | ±0.05nH |

⑧ Features

| Code | Features | Series |
|------|---------------------------------------|------------------------|
| 0 | Standard Type | LQG/LQP/LQW/LQH |
| 1 | High-Q or Low DC Resistance | LQW04A/15A/15C/18A/2BH |
| 8 | Low DC Resistance/ Large Current Type | LQW15A/18A |

⑨ Electrode

•Lead (Pb) Free

| Code | Electrode | Series |
|------|--------------|--|
| 0 | Sn | LQG18H/LQP/LQW□□A/ LQW□□C/LQW21H |
| 2 | | LQG15H/LQP□□H/LQP□□T/ LQP□□M/LQP□□P |
| 3 | LF Solder | LQW□□H/LQH |
| C | non-magnetic | LQW18AS |

⑩ Packaging

| Code | Packaging |
|------|-------------------------------|
| K | Embossed Taping (ø330mm Reel) |
| L/E | Embossed Taping (ø180mm Reel) |
| B | Bulk |
| J | Paper Taping (ø330mm Reel) |
| D | Paper Taping (ø180mm Reel) |

RF Inductors

LQG15HN_02 Series 0402 (1005) inch (mm)



| Packaging Code | Packaging | Minimum Quantity |
|----------------|---------------------|------------------|
| D | ø180mm Paper Taping | 10000 |
| J | ø330mm Paper Taping | 50000 |
| B | Packing in Bulk | 1000 |

| Part Number (□: packaging code) | Inductance | Inductance Test Frequency | Q (min.) | Q Test Frequency | Rated Current | Max. of DC Resistance | S.R.F.* (min.) |
|------------------------------------|--------------|---------------------------|----------|------------------|---------------|-----------------------|----------------|
| LQG15HN1N0B02□ | 1.0nH ±0.1nH | 100MHz | 8 | 100MHz | 1000mA | 0.07Ω | 6000MHz |
| LQG15HN1N0C02□ | 1.0nH ±0.2nH | 100MHz | 8 | 100MHz | 1000mA | 0.07Ω | 6000MHz |
| LQG15HN1N0S02□ | 1.0nH ±0.3nH | 100MHz | 8 | 100MHz | 1000mA | 0.07Ω | 6000MHz |
| LQG15HN1N1B02□ | 1.1nH ±0.1nH | 100MHz | 8 | 100MHz | 1000mA | 0.08Ω | 6000MHz |
| LQG15HN1N1C02□ | 1.1nH ±0.2nH | 100MHz | 8 | 100MHz | 1000mA | 0.08Ω | 6000MHz |
| LQG15HN1N1S02□ | 1.1nH ±0.3nH | 100MHz | 8 | 100MHz | 1000mA | 0.08Ω | 6000MHz |
| LQG15HN1N2B02□ | 1.2nH ±0.1nH | 100MHz | 8 | 100MHz | 1000mA | 0.08Ω | 6000MHz |
| LQG15HN1N2C02□ | 1.2nH ±0.2nH | 100MHz | 8 | 100MHz | 1000mA | 0.08Ω | 6000MHz |
| LQG15HN1N2S02□ | 1.2nH ±0.3nH | 100MHz | 8 | 100MHz | 1000mA | 0.08Ω | 6000MHz |
| LQG15HN1N3B02□ | 1.3nH ±0.1nH | 100MHz | 8 | 100MHz | 1000mA | 0.08Ω | 6000MHz |
| LQG15HN1N3C02□ | 1.3nH ±0.2nH | 100MHz | 8 | 100MHz | 1000mA | 0.08Ω | 6000MHz |
| LQG15HN1N3S02□ | 1.3nH ±0.3nH | 100MHz | 8 | 100MHz | 1000mA | 0.08Ω | 6000MHz |
| LQG15HN1N5B02□ | 1.5nH ±0.1nH | 100MHz | 8 | 100MHz | 1000mA | 0.08Ω | 6000MHz |
| LQG15HN1N5C02□ | 1.5nH ±0.2nH | 100MHz | 8 | 100MHz | 1000mA | 0.08Ω | 6000MHz |
| LQG15HN1N5S02□ | 1.5nH ±0.3nH | 100MHz | 8 | 100MHz | 1000mA | 0.08Ω | 6000MHz |
| LQG15HN1N6B02□ | 1.6nH ±0.1nH | 100MHz | 8 | 100MHz | 1000mA | 0.08Ω | 6000MHz |
| LQG15HN1N6C02□ | 1.6nH ±0.2nH | 100MHz | 8 | 100MHz | 1000mA | 0.08Ω | 6000MHz |
| LQG15HN1N6S02□ | 1.6nH ±0.3nH | 100MHz | 8 | 100MHz | 1000mA | 0.08Ω | 6000MHz |
| LQG15HN1N8B02□ | 1.8nH ±0.1nH | 100MHz | 8 | 100MHz | 900mA | 0.08Ω | 6000MHz |
| LQG15HN1N8C02□ | 1.8nH ±0.2nH | 100MHz | 8 | 100MHz | 900mA | 0.08Ω | 6000MHz |
| LQG15HN1N8S02□ | 1.8nH ±0.3nH | 100MHz | 8 | 100MHz | 900mA | 0.08Ω | 6000MHz |
| LQG15HN2N0B02□ | 2.0nH ±0.1nH | 100MHz | 8 | 100MHz | 900mA | 0.09Ω | 6000MHz |
| LQG15HN2N0C02□ | 2.0nH ±0.2nH | 100MHz | 8 | 100MHz | 900mA | 0.09Ω | 6000MHz |
| LQG15HN2N0S02□ | 2.0nH ±0.3nH | 100MHz | 8 | 100MHz | 900mA | 0.09Ω | 6000MHz |
| LQG15HN2N2B02□ | 2.2nH ±0.1nH | 100MHz | 8 | 100MHz | 900mA | 0.09Ω | 6000MHz |
| LQG15HN2N2C02□ | 2.2nH ±0.2nH | 100MHz | 8 | 100MHz | 900mA | 0.09Ω | 6000MHz |
| LQG15HN2N2S02□ | 2.2nH ±0.3nH | 100MHz | 8 | 100MHz | 900mA | 0.09Ω | 6000MHz |
| LQG15HN2N4B02□ | 2.4nH ±0.1nH | 100MHz | 8 | 100MHz | 800mA | 0.1Ω | 6000MHz |
| LQG15HN2N4C02□ | 2.4nH ±0.2nH | 100MHz | 8 | 100MHz | 800mA | 0.1Ω | 6000MHz |
| LQG15HN2N4S02□ | 2.4nH ±0.3nH | 100MHz | 8 | 100MHz | 800mA | 0.1Ω | 6000MHz |
| LQG15HN2N7B02□ | 2.7nH ±0.1nH | 100MHz | 8 | 100MHz | 800mA | 0.1Ω | 6000MHz |
| LQG15HN2N7C02□ | 2.7nH ±0.2nH | 100MHz | 8 | 100MHz | 800mA | 0.1Ω | 6000MHz |
| LQG15HN2N7S02□ | 2.7nH ±0.3nH | 100MHz | 8 | 100MHz | 800mA | 0.1Ω | 6000MHz |
| LQG15HN3N0B02□ | 3.0nH ±0.1nH | 100MHz | 8 | 100MHz | 800mA | 0.11Ω | 6000MHz |
| LQG15HN3N0C02□ | 3.0nH ±0.2nH | 100MHz | 8 | 100MHz | 800mA | 0.11Ω | 6000MHz |
| LQG15HN3N0S02□ | 3.0nH ±0.3nH | 100MHz | 8 | 100MHz | 800mA | 0.11Ω | 6000MHz |
| LQG15HN3N3B02□ | 3.3nH ±0.1nH | 100MHz | 8 | 100MHz | 800mA | 0.12Ω | 6000MHz |
| LQG15HN3N3C02□ | 3.3nH ±0.2nH | 100MHz | 8 | 100MHz | 800mA | 0.12Ω | 6000MHz |

Operating temp. range: -55 to 125°C

Only for reflow soldering

*S.R.F.: Self Resonant Frequency

Continued on the following page. ↗

Continued from the preceding page. ↘

| Part Number (□: packaging code) | Inductance | Inductance Test Frequency | Q (min.) | Q Test Frequency | Rated Current | Max. of DC Resistance | S.R.F.* (min.) |
|------------------------------------|--------------|------------------------------|----------|------------------|---------------|-----------------------|----------------|
| LQG15HN3N3S02□ | 3.3nH ±0.3nH | 100MHz | 8 | 100MHz | 800mA | 0.12Ω | 6000MHz |
| LQG15HN3N6B02□ | 3.6nH ±0.1nH | 100MHz | 8 | 100MHz | 700mA | 0.13Ω | 6000MHz |
| LQG15HN3N6C02□ | 3.6nH ±0.2nH | 100MHz | 8 | 100MHz | 700mA | 0.13Ω | 6000MHz |
| LQG15HN3N6S02□ | 3.6nH ±0.3nH | 100MHz | 8 | 100MHz | 700mA | 0.13Ω | 6000MHz |
| LQG15HN3N9B02□ | 3.9nH ±0.1nH | 100MHz | 8 | 100MHz | 700mA | 0.13Ω | 6000MHz |
| LQG15HN3N9C02□ | 3.9nH ±0.2nH | 100MHz | 8 | 100MHz | 700mA | 0.13Ω | 6000MHz |
| LQG15HN3N9S02□ | 3.9nH ±0.3nH | 100MHz | 8 | 100MHz | 700mA | 0.13Ω | 6000MHz |
| LQG15HN4N3B02□ | 4.3nH ±0.1nH | 100MHz | 8 | 100MHz | 700mA | 0.15Ω | 6000MHz |
| LQG15HN4N3C02□ | 4.3nH ±0.2nH | 100MHz | 8 | 100MHz | 700mA | 0.15Ω | 6000MHz |
| LQG15HN4N3S02□ | 4.3nH ±0.3nH | 100MHz | 8 | 100MHz | 700mA | 0.15Ω | 6000MHz |
| LQG15HN4N7B02□ | 4.7nH ±0.1nH | 100MHz | 8 | 100MHz | 700mA | 0.16Ω | 6000MHz |
| LQG15HN4N7C02□ | 4.7nH ±0.2nH | 100MHz | 8 | 100MHz | 700mA | 0.16Ω | 6000MHz |
| LQG15HN4N7S02□ | 4.7nH ±0.3nH | 100MHz | 8 | 100MHz | 700mA | 0.16Ω | 6000MHz |
| LQG15HN5N1B02□ | 5.1nH ±0.1nH | 100MHz | 8 | 100MHz | 600mA | 0.16Ω | 6000MHz |
| LQG15HN5N1C02□ | 5.1nH ±0.2nH | 100MHz | 8 | 100MHz | 600mA | 0.16Ω | 6000MHz |
| LQG15HN5N1S02□ | 5.1nH ±0.3nH | 100MHz | 8 | 100MHz | 600mA | 0.16Ω | 6000MHz |
| LQG15HN5N6B02□ | 5.6nH ±0.1nH | 100MHz | 8 | 100MHz | 600mA | 0.18Ω | 5300MHz |
| LQG15HN5N6C02□ | 5.6nH ±0.2nH | 100MHz | 8 | 100MHz | 600mA | 0.18Ω | 5300MHz |
| LQG15HN5N6S02□ | 5.6nH ±0.3nH | 100MHz | 8 | 100MHz | 600mA | 0.18Ω | 5300MHz |
| LQG15HN6N2B02□ | 6.2nH ±0.1nH | 100MHz | 8 | 100MHz | 600mA | 0.19Ω | 4300MHz |
| LQG15HN6N2C02□ | 6.2nH ±0.2nH | 100MHz | 8 | 100MHz | 600mA | 0.19Ω | 4300MHz |
| LQG15HN6N2S02□ | 6.2nH ±0.3nH | 100MHz | 8 | 100MHz | 600mA | 0.19Ω | 4300MHz |
| LQG15HN6N8G02□ | 6.8nH ±2% | 100MHz | 8 | 100MHz | 600mA | 0.21Ω | 4200MHz |
| LQG15HN6N8H02□ | 6.8nH ±3% | 100MHz | 8 | 100MHz | 600mA | 0.21Ω | 4200MHz |
| LQG15HN6N8J02□ | 6.8nH ±5% | 100MHz | 8 | 100MHz | 600mA | 0.21Ω | 4200MHz |
| LQG15HN7N5G02□ | 7.5nH ±2% | 100MHz | 8 | 100MHz | 500mA | 0.24Ω | 3900MHz |
| LQG15HN7N5H02□ | 7.5nH ±3% | 100MHz | 8 | 100MHz | 500mA | 0.24Ω | 3900MHz |
| LQG15HN7N5J02□ | 7.5nH ±5% | 100MHz | 8 | 100MHz | 500mA | 0.24Ω | 3900MHz |
| LQG15HN8N2G02□ | 8.2nH ±2% | 100MHz | 8 | 100MHz | 500mA | 0.25Ω | 3600MHz |
| LQG15HN8N2H02□ | 8.2nH ±3% | 100MHz | 8 | 100MHz | 500mA | 0.25Ω | 3600MHz |
| LQG15HN8N2J02□ | 8.2nH ±5% | 100MHz | 8 | 100MHz | 500mA | 0.25Ω | 3600MHz |
| LQG15HN9N1G02□ | 9.1nH ±2% | 100MHz | 8 | 100MHz | 500mA | 0.27Ω | 3400MHz |
| LQG15HN9N1H02□ | 9.1nH ±3% | 100MHz | 8 | 100MHz | 500mA | 0.27Ω | 3400MHz |
| LQG15HN9N1J02□ | 9.1nH ±5% | 100MHz | 8 | 100MHz | 500mA | 0.27Ω | 3400MHz |
| LQG15HN10NG02□ | 10nH ±2% | 100MHz | 8 | 100MHz | 500mA | 0.29Ω | 3200MHz |
| LQG15HN10NH02□ | 10nH ±3% | 100MHz | 8 | 100MHz | 500mA | 0.29Ω | 3200MHz |
| LQG15HN10NJ02□ | 10nH ±5% | 100MHz | 8 | 100MHz | 500mA | 0.29Ω | 3200MHz |
| LQG15HN12NG02□ | 12nH ±2% | 100MHz | 8 | 100MHz | 400mA | 0.4Ω | 2800MHz |
| LQG15HN12NH02□ | 12nH ±3% | 100MHz | 8 | 100MHz | 400mA | 0.4Ω | 2800MHz |
| LQG15HN12NJ02□ | 12nH ±5% | 100MHz | 8 | 100MHz | 400mA | 0.4Ω | 2800MHz |
| LQG15HN15NG02□ | 15nH ±2% | 100MHz | 8 | 100MHz | 400mA | 0.45Ω | 2300MHz |
| LQG15HN15NH02□ | 15nH ±3% | 100MHz | 8 | 100MHz | 400mA | 0.45Ω | 2300MHz |
| LQG15HN15NJ02□ | 15nH ±5% | 100MHz | 8 | 100MHz | 400mA | 0.45Ω | 2300MHz |
| LQG15HN18NG02□ | 18nH ±2% | 100MHz | 8 | 100MHz | 350mA | 0.51Ω | 2100MHz |
| LQG15HN18NH02□ | 18nH ±3% | 100MHz | 8 | 100MHz | 350mA | 0.51Ω | 2100MHz |
| LQG15HN18NJ02□ | 18nH ±5% | 100MHz | 8 | 100MHz | 350mA | 0.51Ω | 2100MHz |
| LQG15HN22NG02□ | 22nH ±2% | 100MHz | 8 | 100MHz | 350mA | 0.58Ω | 1800MHz |
| LQG15HN22NH02□ | 22nH ±3% | 100MHz | 8 | 100MHz | 350mA | 0.58Ω | 1800MHz |
| LQG15HN22NJ02□ | 22nH ±5% | 100MHz | 8 | 100MHz | 350mA | 0.58Ω | 1800MHz |
| LQG15HN27NG02□ | 27nH ±2% | 100MHz | 8 | 100MHz | 300mA | 0.67Ω | 1600MHz |
| LQG15HN27NH02□ | 27nH ±3% | 100MHz | 8 | 100MHz | 300mA | 0.67Ω | 1600MHz |
| LQG15HN27NJ02□ | 27nH ±5% | 100MHz | 8 | 100MHz | 300mA | 0.67Ω | 1600MHz |
| LQG15HN33NG02□ | 33nH ±2% | 100MHz | 8 | 100MHz | 300mA | 0.67Ω | 1500MHz |

Operating temp. range: -55 to 125°C
 Only for reflow soldering
 *S.R.F.: Self Resonant Frequency

Continued on the following page. ↗

Continued from the preceding page. ↘

| Part Number (□: packaging code) | Inductance | Inductance Test Frequency | Q (min.) | Q Test Frequency | Rated Current | Max. of DC Resistance | S.R.F.* (min.) |
|------------------------------------|------------|---------------------------|----------|------------------|---------------|-----------------------|----------------|
| LQG15HN33NH02□ | 33nH ±3% | 100MHz | 8 | 100MHz | 300mA | 0.67Ω | 1500MHz |
| LQG15HN33NJ02□ | 33nH ±5% | 100MHz | 8 | 100MHz | 300mA | 0.67Ω | 1500MHz |
| LQG15HN39NG02□ | 39nH ±2% | 100MHz | 8 | 100MHz | 250mA | 1.06Ω | 1200MHz |
| LQG15HN39NH02□ | 39nH ±3% | 100MHz | 8 | 100MHz | 250mA | 1.06Ω | 1200MHz |
| LQG15HN39NJ02□ | 39nH ±5% | 100MHz | 8 | 100MHz | 250mA | 1.06Ω | 1200MHz |
| LQG15HN47NG02□ | 47nH ±2% | 100MHz | 8 | 100MHz | 250mA | 1.15Ω | 1000MHz |
| LQG15HN47NH02□ | 47nH ±3% | 100MHz | 8 | 100MHz | 250mA | 1.15Ω | 1000MHz |
| LQG15HN47NJ02□ | 47nH ±5% | 100MHz | 8 | 100MHz | 250mA | 1.15Ω | 1000MHz |
| LQG15HN56NG02□ | 56nH ±2% | 100MHz | 8 | 100MHz | 200mA | 1.2Ω | 800MHz |
| LQG15HN56NH02□ | 56nH ±3% | 100MHz | 8 | 100MHz | 200mA | 1.2Ω | 800MHz |
| LQG15HN56NJ02□ | 56nH ±5% | 100MHz | 8 | 100MHz | 200mA | 1.2Ω | 800MHz |
| LQG15HN68NG02□ | 68nH ±2% | 100MHz | 8 | 100MHz | 200mA | 1.25Ω | 800MHz |
| LQG15HN68NH02□ | 68nH ±3% | 100MHz | 8 | 100MHz | 200mA | 1.25Ω | 800MHz |
| LQG15HN68NJ02□ | 68nH ±5% | 100MHz | 8 | 100MHz | 200mA | 1.25Ω | 800MHz |
| LQG15HN82NG02□ | 82nH ±2% | 100MHz | 8 | 100MHz | 200mA | 1.6Ω | 600MHz |
| LQG15HN82NH02□ | 82nH ±3% | 100MHz | 8 | 100MHz | 200mA | 1.6Ω | 600MHz |
| LQG15HN82NJ02□ | 82nH ±5% | 100MHz | 8 | 100MHz | 200mA | 1.6Ω | 600MHz |
| LQG15HNR10G02□ | 100nH ±2% | 100MHz | 8 | 100MHz | 200mA | 1.6Ω | 600MHz |
| LQG15HNR10H02□ | 100nH ±3% | 100MHz | 8 | 100MHz | 200mA | 1.6Ω | 600MHz |
| LQG15HNR10J02□ | 100nH ±5% | 100MHz | 8 | 100MHz | 200mA | 1.6Ω | 600MHz |
| LQG15HNR12G02□ | 120nH ±2% | 100MHz | 8 | 100MHz | 150mA | 1.6Ω | 600MHz |
| LQG15HNR12H02□ | 120nH ±3% | 100MHz | 8 | 100MHz | 150mA | 1.6Ω | 600MHz |
| LQG15HNR12J02□ | 120nH ±5% | 100MHz | 8 | 100MHz | 150mA | 1.6Ω | 600MHz |

Operating temp. range: -55 to 125°C

Only for reflow soldering

*S.R.F.: Self Resonant Frequency

Inductance-Frequency Characteristics (Typ.)



Q-Frequency Characteristics (Typ.)



LQG15HS_02 Series 0402 (1005) inch (mm)



| Packaging Code | Packaging | Minimum Quantity |
|----------------|---------------------|------------------|
| D | ø180mm Paper Taping | 10000 |
| J | ø330mm Paper Taping | 50000 |
| B | Packing in Bulk | 1000 |

Continued on the following page. ↗

Continued from the preceding page. ↘

| Part Number (□: packaging code) | Inductance | Inductance Test Frequency | Q (min.) | Q Test Frequency | Rated Current | Max. of DC Resistance | S.R.F.* (min.) |
|------------------------------------|--------------|------------------------------|----------|------------------|---------------|-----------------------|----------------|
| LQG15HS1N0B02□ | 1.0nH ±0.1nH | 100MHz | 8 | 100MHz | 1000mA | 0.07Ω | 10000MHz |
| LQG15HS1N0C02□ | 1.0nH ±0.2nH | 100MHz | 8 | 100MHz | 1000mA | 0.07Ω | 10000MHz |
| LQG15HS1N0S02□ | 1.0nH ±0.3nH | 100MHz | 8 | 100MHz | 1000mA | 0.07Ω | 10000MHz |
| LQG15HS1N1B02□ | 1.1nH ±0.1nH | 100MHz | 8 | 100MHz | 1000mA | 0.07Ω | 6000MHz |
| LQG15HS1N1C02□ | 1.1nH ±0.2nH | 100MHz | 8 | 100MHz | 1000mA | 0.07Ω | 6000MHz |
| LQG15HS1N1S02□ | 1.1nH ±0.3nH | 100MHz | 8 | 100MHz | 1000mA | 0.07Ω | 6000MHz |
| LQG15HS1N2B02□ | 1.2nH ±0.1nH | 100MHz | 8 | 100MHz | 1000mA | 0.07Ω | 6000MHz |
| LQG15HS1N2C02□ | 1.2nH ±0.2nH | 100MHz | 8 | 100MHz | 1000mA | 0.07Ω | 6000MHz |
| LQG15HS1N2S02□ | 1.2nH ±0.3nH | 100MHz | 8 | 100MHz | 1000mA | 0.07Ω | 6000MHz |
| LQG15HS1N3B02□ | 1.3nH ±0.1nH | 100MHz | 8 | 100MHz | 1000mA | 0.07Ω | 6000MHz |
| LQG15HS1N3C02□ | 1.3nH ±0.2nH | 100MHz | 8 | 100MHz | 1000mA | 0.07Ω | 6000MHz |
| LQG15HS1N3S02□ | 1.3nH ±0.3nH | 100MHz | 8 | 100MHz | 1000mA | 0.07Ω | 6000MHz |
| LQG15HS1N5B02□ | 1.5nH ±0.1nH | 100MHz | 8 | 100MHz | 1000mA | 0.07Ω | 6000MHz |
| LQG15HS1N5C02□ | 1.5nH ±0.2nH | 100MHz | 8 | 100MHz | 1000mA | 0.07Ω | 6000MHz |
| LQG15HS1N5S02□ | 1.5nH ±0.3nH | 100MHz | 8 | 100MHz | 1000mA | 0.07Ω | 6000MHz |
| LQG15HS1N6B02□ | 1.6nH ±0.1nH | 100MHz | 8 | 100MHz | 1000mA | 0.07Ω | 6000MHz |
| LQG15HS1N6C02□ | 1.6nH ±0.2nH | 100MHz | 8 | 100MHz | 1000mA | 0.07Ω | 6000MHz |
| LQG15HS1N6S02□ | 1.6nH ±0.3nH | 100MHz | 8 | 100MHz | 1000mA | 0.07Ω | 6000MHz |
| LQG15HS1N8B02□ | 1.8nH ±0.1nH | 100MHz | 8 | 100MHz | 950mA | 0.08Ω | 6000MHz |
| LQG15HS1N8C02□ | 1.8nH ±0.2nH | 100MHz | 8 | 100MHz | 950mA | 0.08Ω | 6000MHz |
| LQG15HS1N8S02□ | 1.8nH ±0.3nH | 100MHz | 8 | 100MHz | 950mA | 0.08Ω | 6000MHz |
| LQG15HS2N0B02□ | 2.0nH ±0.1nH | 100MHz | 8 | 100MHz | 900mA | 0.09Ω | 6000MHz |
| LQG15HS2N0C02□ | 2.0nH ±0.2nH | 100MHz | 8 | 100MHz | 900mA | 0.09Ω | 6000MHz |
| LQG15HS2N0S02□ | 2.0nH ±0.3nH | 100MHz | 8 | 100MHz | 900mA | 0.09Ω | 6000MHz |
| LQG15HS2N2B02□ | 2.2nH ±0.1nH | 100MHz | 8 | 100MHz | 900mA | 0.09Ω | 6000MHz |
| LQG15HS2N2C02□ | 2.2nH ±0.2nH | 100MHz | 8 | 100MHz | 900mA | 0.09Ω | 6000MHz |
| LQG15HS2N2S02□ | 2.2nH ±0.3nH | 100MHz | 8 | 100MHz | 900mA | 0.09Ω | 6000MHz |
| LQG15HS2N4B02□ | 2.4nH ±0.1nH | 100MHz | 8 | 100MHz | 850mA | 0.11Ω | 6000MHz |
| LQG15HS2N4C02□ | 2.4nH ±0.2nH | 100MHz | 8 | 100MHz | 850mA | 0.11Ω | 6000MHz |
| LQG15HS2N4S02□ | 2.4nH ±0.3nH | 100MHz | 8 | 100MHz | 850mA | 0.11Ω | 6000MHz |
| LQG15HS2N7B02□ | 2.7nH ±0.1nH | 100MHz | 8 | 100MHz | 800mA | 0.12Ω | 6000MHz |
| LQG15HS2N7C02□ | 2.7nH ±0.2nH | 100MHz | 8 | 100MHz | 800mA | 0.12Ω | 6000MHz |
| LQG15HS2N7S02□ | 2.7nH ±0.3nH | 100MHz | 8 | 100MHz | 800mA | 0.12Ω | 6000MHz |
| LQG15HS3N0B02□ | 3.0nH ±0.1nH | 100MHz | 8 | 100MHz | 800mA | 0.125Ω | 6000MHz |
| LQG15HS3N0C02□ | 3.0nH ±0.2nH | 100MHz | 8 | 100MHz | 800mA | 0.125Ω | 6000MHz |
| LQG15HS3N0S02□ | 3.0nH ±0.3nH | 100MHz | 8 | 100MHz | 800mA | 0.125Ω | 6000MHz |
| LQG15HS3N3B02□ | 3.3nH ±0.1nH | 100MHz | 8 | 100MHz | 800mA | 0.125Ω | 6000MHz |
| LQG15HS3N3C02□ | 3.3nH ±0.2nH | 100MHz | 8 | 100MHz | 800mA | 0.125Ω | 6000MHz |
| LQG15HS3N3S02□ | 3.3nH ±0.3nH | 100MHz | 8 | 100MHz | 800mA | 0.125Ω | 6000MHz |
| LQG15HS3N6B02□ | 3.6nH ±0.1nH | 100MHz | 8 | 100MHz | 750mA | 0.14Ω | 6000MHz |
| LQG15HS3N6C02□ | 3.6nH ±0.2nH | 100MHz | 8 | 100MHz | 750mA | 0.14Ω | 6000MHz |
| LQG15HS3N6S02□ | 3.6nH ±0.3nH | 100MHz | 8 | 100MHz | 750mA | 0.14Ω | 6000MHz |
| LQG15HS3N9B02□ | 3.9nH ±0.1nH | 100MHz | 8 | 100MHz | 750mA | 0.14Ω | 6000MHz |
| LQG15HS3N9C02□ | 3.9nH ±0.2nH | 100MHz | 8 | 100MHz | 750mA | 0.14Ω | 6000MHz |
| LQG15HS3N9S02□ | 3.9nH ±0.3nH | 100MHz | 8 | 100MHz | 750mA | 0.14Ω | 6000MHz |
| LQG15HS4N3B02□ | 4.3nH ±0.1nH | 100MHz | 8 | 100MHz | 750mA | 0.14Ω | 6000MHz |
| LQG15HS4N3C02□ | 4.3nH ±0.2nH | 100MHz | 8 | 100MHz | 750mA | 0.14Ω | 6000MHz |
| LQG15HS4N3S02□ | 4.3nH ±0.3nH | 100MHz | 8 | 100MHz | 750mA | 0.14Ω | 6000MHz |
| LQG15HS4N7B02□ | 4.7nH ±0.1nH | 100MHz | 8 | 100MHz | 700mA | 0.16Ω | 6000MHz |
| LQG15HS4N7C02□ | 4.7nH ±0.2nH | 100MHz | 8 | 100MHz | 700mA | 0.16Ω | 6000MHz |
| LQG15HS4N7S02□ | 4.7nH ±0.3nH | 100MHz | 8 | 100MHz | 700mA | 0.16Ω | 6000MHz |
| LQG15HS5N1B02□ | 5.1nH ±0.1nH | 100MHz | 8 | 100MHz | 650mA | 0.18Ω | 5300MHz |
| LQG15HS5N1C02□ | 5.1nH ±0.2nH | 100MHz | 8 | 100MHz | 650mA | 0.18Ω | 5300MHz |

Operating temp. range: -55 to 125°C
 Only for reflow soldering
 *S.R.F.: Self Resonant Frequency

Continued on the following page. ↗

Continued from the preceding page. ↘

| Part Number (□: packaging code) | Inductance | Inductance Test Frequency | Q (min.) | Q Test Frequency | Rated Current | Max. of DC Resistance | S.R.F.* (min.) |
|------------------------------------|--------------|------------------------------|----------|------------------|---------------|-----------------------|----------------|
| LQG15HS5N1S02□ | 5.1nH ±0.3nH | 100MHz | 8 | 100MHz | 650mA | 0.18Ω | 5300MHz |
| LQG15HS5N6B02□ | 5.6nH ±0.1nH | 100MHz | 8 | 100MHz | 650mA | 0.18Ω | 4500MHz |
| LQG15HS5N6C02□ | 5.6nH ±0.2nH | 100MHz | 8 | 100MHz | 650mA | 0.18Ω | 4500MHz |
| LQG15HS5N6S02□ | 5.6nH ±0.3nH | 100MHz | 8 | 100MHz | 650mA | 0.18Ω | 4500MHz |
| LQG15HS6N2B02□ | 6.2nH ±0.1nH | 100MHz | 8 | 100MHz | 600mA | 0.2Ω | 4500MHz |
| LQG15HS6N2C02□ | 6.2nH ±0.2nH | 100MHz | 8 | 100MHz | 600mA | 0.2Ω | 4500MHz |
| LQG15HS6N2S02□ | 6.2nH ±0.3nH | 100MHz | 8 | 100MHz | 600mA | 0.2Ω | 4500MHz |
| LQG15HS6N8G02□ | 6.8nH ±2% | 100MHz | 8 | 100MHz | 600mA | 0.22Ω | 4500MHz |
| LQG15HS6N8H02□ | 6.8nH ±3% | 100MHz | 8 | 100MHz | 600mA | 0.22Ω | 4500MHz |
| LQG15HS6N8J02□ | 6.8nH ±5% | 100MHz | 8 | 100MHz | 600mA | 0.22Ω | 4500MHz |
| LQG15HS7N5G02□ | 7.5nH ±2% | 100MHz | 8 | 100MHz | 550mA | 0.24Ω | 4200MHz |
| LQG15HS7N5H02□ | 7.5nH ±3% | 100MHz | 8 | 100MHz | 550mA | 0.24Ω | 4200MHz |
| LQG15HS7N5J02□ | 7.5nH ±5% | 100MHz | 8 | 100MHz | 550mA | 0.24Ω | 4200MHz |
| LQG15HS8N2G02□ | 8.2nH ±2% | 100MHz | 8 | 100MHz | 550mA | 0.24Ω | 3700MHz |
| LQG15HS8N2H02□ | 8.2nH ±3% | 100MHz | 8 | 100MHz | 550mA | 0.24Ω | 3700MHz |
| LQG15HS8N2J02□ | 8.2nH ±5% | 100MHz | 8 | 100MHz | 550mA | 0.24Ω | 3700MHz |
| LQG15HS9N1G02□ | 9.1nH ±2% | 100MHz | 8 | 100MHz | 500mA | 0.26Ω | 3400MHz |
| LQG15HS9N1H02□ | 9.1nH ±3% | 100MHz | 8 | 100MHz | 500mA | 0.26Ω | 3400MHz |
| LQG15HS9N1J02□ | 9.1nH ±5% | 100MHz | 8 | 100MHz | 500mA | 0.26Ω | 3400MHz |
| LQG15HS10NG02□ | 10nH ±2% | 100MHz | 8 | 100MHz | 500mA | 0.26Ω | 3400MHz |
| LQG15HS10NH02□ | 10nH ±3% | 100MHz | 8 | 100MHz | 500mA | 0.26Ω | 3400MHz |
| LQG15HS10NJ02□ | 10nH ±5% | 100MHz | 8 | 100MHz | 500mA | 0.26Ω | 3400MHz |
| LQG15HS12NG02□ | 12nH ±2% | 100MHz | 8 | 100MHz | 500mA | 0.28Ω | 3000MHz |
| LQG15HS12NH02□ | 12nH ±3% | 100MHz | 8 | 100MHz | 500mA | 0.28Ω | 3000MHz |
| LQG15HS12NJ02□ | 12nH ±5% | 100MHz | 8 | 100MHz | 500mA | 0.28Ω | 3000MHz |
| LQG15HS15NG02□ | 15nH ±2% | 100MHz | 8 | 100MHz | 450mA | 0.32Ω | 2500MHz |
| LQG15HS15NH02□ | 15nH ±3% | 100MHz | 8 | 100MHz | 450mA | 0.32Ω | 2500MHz |
| LQG15HS15NJ02□ | 15nH ±5% | 100MHz | 8 | 100MHz | 450mA | 0.32Ω | 2500MHz |
| LQG15HS18NG02□ | 18nH ±2% | 100MHz | 8 | 100MHz | 400mA | 0.36Ω | 2200MHz |
| LQG15HS18NH02□ | 18nH ±3% | 100MHz | 8 | 100MHz | 400mA | 0.36Ω | 2200MHz |
| LQG15HS18NJ02□ | 18nH ±5% | 100MHz | 8 | 100MHz | 400mA | 0.36Ω | 2200MHz |
| LQG15HS22NG02□ | 22nH ±2% | 100MHz | 8 | 100MHz | 350mA | 0.42Ω | 1900MHz |
| LQG15HS22NH02□ | 22nH ±3% | 100MHz | 8 | 100MHz | 350mA | 0.42Ω | 1900MHz |
| LQG15HS22NJ02□ | 22nH ±5% | 100MHz | 8 | 100MHz | 350mA | 0.42Ω | 1900MHz |
| LQG15HS27NG02□ | 27nH ±2% | 100MHz | 8 | 100MHz | 350mA | 0.46Ω | 1700MHz |
| LQG15HS27NH02□ | 27nH ±3% | 100MHz | 8 | 100MHz | 350mA | 0.46Ω | 1700MHz |
| LQG15HS27NJ02□ | 27nH ±5% | 100MHz | 8 | 100MHz | 350mA | 0.46Ω | 1700MHz |
| LQG15HS33NG02□ | 33nH ±2% | 100MHz | 8 | 100MHz | 350mA | 0.58Ω | 1600MHz |
| LQG15HS33NH02□ | 33nH ±3% | 100MHz | 8 | 100MHz | 350mA | 0.58Ω | 1600MHz |
| LQG15HS33NJ02□ | 33nH ±5% | 100MHz | 8 | 100MHz | 350mA | 0.58Ω | 1600MHz |
| LQG15HS39NG02□ | 39nH ±2% | 100MHz | 8 | 100MHz | 300mA | 0.65Ω | 1200MHz |
| LQG15HS39NH02□ | 39nH ±3% | 100MHz | 8 | 100MHz | 300mA | 0.65Ω | 1200MHz |
| LQG15HS39NJ02□ | 39nH ±5% | 100MHz | 8 | 100MHz | 300mA | 0.65Ω | 1200MHz |
| LQG15HS47NG02□ | 47nH ±2% | 100MHz | 8 | 100MHz | 300mA | 0.72Ω | 1000MHz |
| LQG15HS47NH02□ | 47nH ±3% | 100MHz | 8 | 100MHz | 300mA | 0.72Ω | 1000MHz |
| LQG15HS47NJ02□ | 47nH ±5% | 100MHz | 8 | 100MHz | 300mA | 0.72Ω | 1000MHz |
| LQG15HS56NG02□ | 56nH ±2% | 100MHz | 8 | 100MHz | 250mA | 0.82Ω | 800MHz |
| LQG15HS56NH02□ | 56nH ±3% | 100MHz | 8 | 100MHz | 250mA | 0.82Ω | 800MHz |
| LQG15HS56NJ02□ | 56nH ±5% | 100MHz | 8 | 100MHz | 250mA | 0.82Ω | 800MHz |
| LQG15HS68NG02□ | 68nH ±2% | 100MHz | 8 | 100MHz | 250mA | 0.92Ω | 800MHz |
| LQG15HS68NH02□ | 68nH ±3% | 100MHz | 8 | 100MHz | 250mA | 0.92Ω | 800MHz |
| LQG15HS68NJ02□ | 68nH ±5% | 100MHz | 8 | 100MHz | 250mA | 0.92Ω | 800MHz |
| LQG15HS82NG02□ | 82nH ±2% | 100MHz | 8 | 100MHz | 200mA | 1.2Ω | 700MHz |

Operating temp. range: -55 to 125°C
 Only for reflow soldering
 *S.R.F.: Self Resonant Frequency

Continued on the following page. ↗

Continued from the preceding page. ↘

| Part Number (□: packaging code) | Inductance | Inductance Test Frequency | Q (min.) | Q Test Frequency | Rated Current | Max. of DC Resistance | S.R.F.* (min.) |
|------------------------------------|------------|---------------------------|----------|------------------|---------------|-----------------------|----------------|
| LQG15HS82NH02□ | 82nH ±3% | 100MHz | 8 | 100MHz | 200mA | 1.2Ω | 700MHz |
| LQG15HS82NJ02□ | 82nH ±5% | 100MHz | 8 | 100MHz | 200mA | 1.2Ω | 700MHz |
| LQG15HSR10G02□ | 100nH ±2% | 100MHz | 8 | 100MHz | 200mA | 1.25Ω | 600MHz |
| LQG15HSR10H02□ | 100nH ±3% | 100MHz | 8 | 100MHz | 200mA | 1.25Ω | 600MHz |
| LQG15HSR10J02□ | 100nH ±5% | 100MHz | 8 | 100MHz | 200mA | 1.25Ω | 600MHz |
| LQG15HSR12G02□ | 120nH ±2% | 100MHz | 8 | 100MHz | 200mA | 1.3Ω | 600MHz |
| LQG15HSR12H02□ | 120nH ±3% | 100MHz | 8 | 100MHz | 200mA | 1.3Ω | 600MHz |
| LQG15HSR12J02□ | 120nH ±5% | 100MHz | 8 | 100MHz | 200mA | 1.3Ω | 600MHz |
| LQG15HSR15G02□ | 150nH ±2% | 100MHz | 8 | 100MHz | 150mA | 2.99Ω | 550MHz |
| LQG15HSR15H02□ | 150nH ±3% | 100MHz | 8 | 100MHz | 150mA | 2.99Ω | 550MHz |
| LQG15HSR15J02□ | 150nH ±5% | 100MHz | 8 | 100MHz | 150mA | 2.99Ω | 550MHz |
| LQG15HSR18G02□ | 180nH ±2% | 100MHz | 8 | 100MHz | 150mA | 3.38Ω | 500MHz |
| LQG15HSR18H02□ | 180nH ±3% | 100MHz | 8 | 100MHz | 150mA | 3.38Ω | 500MHz |
| LQG15HSR18J02□ | 180nH ±5% | 100MHz | 8 | 100MHz | 150mA | 3.38Ω | 500MHz |
| LQG15HSR22G02□ | 220nH ±2% | 100MHz | 8 | 100MHz | 120mA | 3.77Ω | 450MHz |
| LQG15HSR22H02□ | 220nH ±3% | 100MHz | 8 | 100MHz | 120mA | 3.77Ω | 450MHz |
| LQG15HSR22J02□ | 220nH ±5% | 100MHz | 8 | 100MHz | 120mA | 3.77Ω | 450MHz |
| LQG15HSR27G02□ | 270nH ±2% | 100MHz | 8 | 100MHz | 110mA | 4.94Ω | 400MHz |
| LQG15HSR27H02□ | 270nH ±3% | 100MHz | 8 | 100MHz | 110mA | 4.94Ω | 400MHz |
| LQG15HSR27J02□ | 270nH ±5% | 100MHz | 8 | 100MHz | 110mA | 4.94Ω | 400MHz |

Operating temp. range: -55 to 125°C
 Only for reflow soldering
 *S.R.F.: Self Resonant Frequency

Inductance-Frequency Characteristics (Typ.)



Q-Frequency Characteristics (Typ.)



LQG18HN_00 Series 0603 (1608) inch (mm)



(in mm)

| Packaging Code | Packaging | Minimum Quantity |
|----------------|---------------------|------------------|
| D | ø180mm Paper Taping | 4000 |
| J | ø330mm Paper Taping | 10000 |
| B | Packing in Bulk | 1000 |

Continued on the following page. ↗

Continued from the preceding page. ↘

| Part Number (□: packaging code) | Inductance | Inductance Test Frequency | Q (min.) | Q Test Frequency | Rated Current | Max. of DC Resistance | S.R.F.* (min.) |
|------------------------------------|--------------|---------------------------|----------|------------------|---------------|-----------------------|----------------|
| LQG18HN1N2S00□ | 1.2nH ±0.3nH | 100MHz | 12 | 100MHz | 1100mA | 0.10Ω | 6000MHz |
| LQG18HN1N5S00□ | 1.5nH ±0.3nH | 100MHz | 12 | 100MHz | 1100mA | 0.10Ω | 6000MHz |
| LQG18HN1N8S00□ | 1.8nH ±0.3nH | 100MHz | 12 | 100MHz | 1100mA | 0.10Ω | 6000MHz |
| LQG18HN2N2S00□ | 2.2nH ±0.3nH | 100MHz | 12 | 100MHz | 1100mA | 0.10Ω | 6000MHz |
| LQG18HN2N7S00□ | 2.7nH ±0.3nH | 100MHz | 12 | 100MHz | 1000mA | 0.12Ω | 6000MHz |
| LQG18HN3N3S00□ | 3.3nH ±0.3nH | 100MHz | 12 | 100MHz | 1000mA | 0.12Ω | 6000MHz |
| LQG18HN3N9S00□ | 3.9nH ±0.3nH | 100MHz | 12 | 100MHz | 900mA | 0.15Ω | 6000MHz |
| LQG18HN4N7S00□ | 4.7nH ±0.3nH | 100MHz | 12 | 100MHz | 900mA | 0.15Ω | 6000MHz |
| LQG18HN5N6S00□ | 5.6nH ±0.3nH | 100MHz | 12 | 100MHz | 800mA | 0.20Ω | 5000MHz |
| LQG18HN6N8J00□ | 6.8nH ±5% | 100MHz | 12 | 100MHz | 800mA | 0.20Ω | 5000MHz |
| LQG18HN8N2J00□ | 8.2nH ±5% | 100MHz | 12 | 100MHz | 800mA | 0.20Ω | 4000MHz |
| LQG18HN10NJ00□ | 10nH ±5% | 100MHz | 12 | 100MHz | 650mA | 0.30Ω | 3500MHz |
| LQG18HN12NJ00□ | 12nH ±5% | 100MHz | 12 | 100MHz | 600mA | 0.35Ω | 3000MHz |
| LQG18HN15NJ00□ | 15nH ±5% | 100MHz | 12 | 100MHz | 600mA | 0.35Ω | 2800MHz |
| LQG18HN18NJ00□ | 18nH ±5% | 100MHz | 12 | 100MHz | 600mA | 0.37Ω | 2600MHz |
| LQG18HN22NJ00□ | 22nH ±5% | 100MHz | 12 | 100MHz | 500mA | 0.50Ω | 2300MHz |
| LQG18HN27NJ00□ | 27nH ±5% | 100MHz | 12 | 100MHz | 500mA | 0.54Ω | 2000MHz |
| LQG18HN33NJ00□ | 33nH ±5% | 100MHz | 12 | 100MHz | 500mA | 0.54Ω | 1700MHz |
| LQG18HN39NJ00□ | 39nH ±5% | 100MHz | 12 | 100MHz | 450mA | 0.60Ω | 1500MHz |
| LQG18HN47NJ00□ | 47nH ±5% | 100MHz | 12 | 100MHz | 400mA | 0.70Ω | 1200MHz |
| LQG18HN56NJ00□ | 56nH ±5% | 100MHz | 12 | 100MHz | 400mA | 0.75Ω | 1100MHz |
| LQG18HN68NJ00□ | 68nH ±5% | 100MHz | 12 | 100MHz | 400mA | 0.80Ω | 1000MHz |
| LQG18HN82NJ00□ | 82nH ±5% | 100MHz | 12 | 100MHz | 350mA | 0.85Ω | 900MHz |
| LQG18HNR10J00□ | 100nH ±5% | 100MHz | 12 | 100MHz | 350mA | 0.90Ω | 800MHz |

Operating temp. range: -40 to 85°C

Only for reflow soldering

*S.R.F.: Self Resonant Frequency

Inductance-Frequency Characteristics (Typ.)



Q-Frequency Characteristics (Typ.)



LQP02HQ_02 Series 01005 (0402) inch (mm)



| Packaging Code | Packaging | Minimum Quantity |
|----------------|------------------------|------------------|
| E | ø180mm Embossed Taping | 15000 |
| L | ø180mm Embossed Taping | 30000 |
| B | Packing in Bulk | 500 |

Continued on the following page. ↗

Continued from the preceding page. ↘

| Part Number (□: packaging code) | Inductance | Inductance Test Frequency | Q (min.) | Q Test Frequency | Rated Current | Max. of DC Resistance | S.R.F.* (min.) |
|------------------------------------|---------------|------------------------------|----------|------------------|---------------|-----------------------|----------------|
| LQP02HQ0N2W02□ | 0.2nH ±0.05nH | 500MHz | - | 500MHz | 1000mA | 0.01Ω | 17.0GHz |
| LQP02HQ0N2B02□ | 0.2nH ±0.1nH | 500MHz | - | 500MHz | 1000mA | 0.01Ω | 17.0GHz |
| LQP02HQ0N2C02□ | 0.2nH ±0.2nH | 500MHz | - | 500MHz | 1000mA | 0.01Ω | 17.0GHz |
| LQP02HQ0N3W02□ | 0.3nH ±0.05nH | 500MHz | - | 500MHz | 1000mA | 0.02Ω | 17.0GHz |
| LQP02HQ0N3B02□ | 0.3nH ±0.1nH | 500MHz | - | 500MHz | 1000mA | 0.02Ω | 17.0GHz |
| LQP02HQ0N3C02□ | 0.3nH ±0.2nH | 500MHz | - | 500MHz | 1000mA | 0.02Ω | 17.0GHz |
| LQP02HQ0N4W02□ | 0.4nH ±0.05nH | 500MHz | 14 | 500MHz | 1000mA | 0.03Ω | 17.0GHz |
| LQP02HQ0N4B02□ | 0.4nH ±0.1nH | 500MHz | 14 | 500MHz | 1000mA | 0.03Ω | 17.0GHz |
| LQP02HQ0N4C02□ | 0.4nH ±0.2nH | 500MHz | 14 | 500MHz | 1000mA | 0.03Ω | 17.0GHz |
| LQP02HQ0N5W02□ | 0.5nH ±0.05nH | 500MHz | 14 | 500MHz | 1000mA | 0.04Ω | 17.0GHz |
| LQP02HQ0N5B02□ | 0.5nH ±0.1nH | 500MHz | 14 | 500MHz | 1000mA | 0.04Ω | 17.0GHz |
| LQP02HQ0N5C02□ | 0.5nH ±0.2nH | 500MHz | 14 | 500MHz | 1000mA | 0.04Ω | 17.0GHz |
| LQP02HQ0N6W02□ | 0.6nH ±0.05nH | 500MHz | 14 | 500MHz | 950mA | 0.05Ω | 17.0GHz |
| LQP02HQ0N6B02□ | 0.6nH ±0.1nH | 500MHz | 14 | 500MHz | 950mA | 0.05Ω | 17.0GHz |
| LQP02HQ0N6C02□ | 0.6nH ±0.2nH | 500MHz | 14 | 500MHz | 950mA | 0.05Ω | 17.0GHz |
| LQP02HQ0N7W02□ | 0.7nH ±0.05nH | 500MHz | 14 | 500MHz | 900mA | 0.05Ω | 15.5GHz |
| LQP02HQ0N7B02□ | 0.7nH ±0.1nH | 500MHz | 14 | 500MHz | 900mA | 0.05Ω | 15.5GHz |
| LQP02HQ0N7C02□ | 0.7nH ±0.2nH | 500MHz | 14 | 500MHz | 900mA | 0.05Ω | 15.5GHz |
| LQP02HQ0N8W02□ | 0.8nH ±0.05nH | 500MHz | 14 | 500MHz | 900mA | 0.05Ω | 15.5GHz |
| LQP02HQ0N8B02□ | 0.8nH ±0.1nH | 500MHz | 14 | 500MHz | 900mA | 0.05Ω | 15.5GHz |
| LQP02HQ0N8C02□ | 0.8nH ±0.2nH | 500MHz | 14 | 500MHz | 900mA | 0.05Ω | 15.5GHz |
| LQP02HQ0N9W02□ | 0.9nH ±0.05nH | 500MHz | 14 | 500MHz | 900mA | 0.05Ω | 14.6GHz |
| LQP02HQ0N9B02□ | 0.9nH ±0.1nH | 500MHz | 14 | 500MHz | 900mA | 0.05Ω | 14.6GHz |
| LQP02HQ0N9C02□ | 0.9nH ±0.2nH | 500MHz | 14 | 500MHz | 900mA | 0.05Ω | 14.6GHz |
| LQP02HQ1N0W02□ | 1.0nH ±0.05nH | 500MHz | 14 | 500MHz | 900mA | 0.05Ω | 13.2GHz |
| LQP02HQ1N0B02□ | 1.0nH ±0.1nH | 500MHz | 14 | 500MHz | 900mA | 0.05Ω | 13.2GHz |
| LQP02HQ1N0C02□ | 1.0nH ±0.2nH | 500MHz | 14 | 500MHz | 900mA | 0.05Ω | 13.2GHz |
| LQP02HQ1N1W02□ | 1.1nH ±0.05nH | 500MHz | 14 | 500MHz | 850mA | 0.06Ω | 12.8GHz |
| LQP02HQ1N1B02□ | 1.1nH ±0.1nH | 500MHz | 14 | 500MHz | 850mA | 0.06Ω | 12.8GHz |
| LQP02HQ1N1C02□ | 1.1nH ±0.2nH | 500MHz | 14 | 500MHz | 850mA | 0.06Ω | 12.8GHz |
| LQP02HQ1N2W02□ | 1.2nH ±0.05nH | 500MHz | 14 | 500MHz | 800mA | 0.06Ω | 12.8GHz |
| LQP02HQ1N2B02□ | 1.2nH ±0.1nH | 500MHz | 14 | 500MHz | 800mA | 0.06Ω | 12.8GHz |
| LQP02HQ1N2C02□ | 1.2nH ±0.2nH | 500MHz | 14 | 500MHz | 800mA | 0.06Ω | 12.8GHz |
| LQP02HQ1N3W02□ | 1.3nH ±0.05nH | 500MHz | 14 | 500MHz | 700mA | 0.08Ω | 12.7GHz |
| LQP02HQ1N3B02□ | 1.3nH ±0.1nH | 500MHz | 14 | 500MHz | 700mA | 0.08Ω | 12.7GHz |
| LQP02HQ1N3C02□ | 1.3nH ±0.2nH | 500MHz | 14 | 500MHz | 700mA | 0.08Ω | 12.7GHz |
| LQP02HQ1N4W02□ | 1.4nH ±0.05nH | 500MHz | 14 | 500MHz | 700mA | 0.08Ω | 12.7GHz |
| LQP02HQ1N4B02□ | 1.4nH ±0.1nH | 500MHz | 14 | 500MHz | 700mA | 0.08Ω | 12.7GHz |
| LQP02HQ1N4C02□ | 1.4nH ±0.2nH | 500MHz | 14 | 500MHz | 700mA | 0.08Ω | 12.7GHz |
| LQP02HQ1N5W02□ | 1.5nH ±0.05nH | 500MHz | 14 | 500MHz | 700mA | 0.08Ω | 12.7GHz |
| LQP02HQ1N5B02□ | 1.5nH ±0.1nH | 500MHz | 14 | 500MHz | 700mA | 0.08Ω | 12.7GHz |
| LQP02HQ1N5C02□ | 1.5nH ±0.2nH | 500MHz | 14 | 500MHz | 700mA | 0.08Ω | 12.7GHz |
| LQP02HQ1N6B02□ | 1.6nH ±0.1nH | 500MHz | 14 | 500MHz | 700mA | 0.08Ω | 10.7GHz |
| LQP02HQ1N6C02□ | 1.6nH ±0.2nH | 500MHz | 14 | 500MHz | 700mA | 0.08Ω | 10.7GHz |
| LQP02HQ1N7B02□ | 1.7nH ±0.1nH | 500MHz | 14 | 500MHz | 700mA | 0.08Ω | 10.7GHz |
| LQP02HQ1N7C02□ | 1.7nH ±0.2nH | 500MHz | 14 | 500MHz | 700mA | 0.08Ω | 10.7GHz |
| LQP02HQ1N8B02□ | 1.8nH ±0.1nH | 500MHz | 14 | 500MHz | 700mA | 0.08Ω | 10.2GHz |
| LQP02HQ1N8C02□ | 1.8nH ±0.2nH | 500MHz | 14 | 500MHz | 700mA | 0.08Ω | 10.2GHz |
| LQP02HQ1N9B02□ | 1.9nH ±0.1nH | 500MHz | 14 | 500MHz | 700mA | 0.08Ω | 10.2GHz |
| LQP02HQ1N9C02□ | 1.9nH ±0.2nH | 500MHz | 14 | 500MHz | 700mA | 0.08Ω | 10.2GHz |
| LQP02HQ2N0B02□ | 2.0nH ±0.1nH | 500MHz | 14 | 500MHz | 700mA | 0.1Ω | 10.1GHz |
| LQP02HQ2N0C02□ | 2.0nH ±0.2nH | 500MHz | 14 | 500MHz | 700mA | 0.1Ω | 10.1GHz |
| LQP02HQ2N1B02□ | 2.1nH ±0.1nH | 500MHz | 14 | 500MHz | 650mA | 0.1Ω | 10.1GHz |

Operating temp. range: -55 to 125°C
 Only for reflow soldering
 *S.R.F.: Self Resonant Frequency

Continued on the following page. ↗

Inductors for Power Lines

Inductors for General Circuits

RF Inductors
 LQP02HQ_02

Continued from the preceding page. ↘

| Part Number (□: packaging code) | Inductance | Inductance Test Frequency | Q (min.) | Q Test Frequency | Rated Current | Max. of DC Resistance | S.R.F.* (min.) |
|------------------------------------|--------------|------------------------------|----------|------------------|---------------|-----------------------|----------------|
| LQP02HQ2N1C02□ | 2.1nH ±0.2nH | 500MHz | 14 | 500MHz | 650mA | 0.1Ω | 10.1GHz |
| LQP02HQ2N2B02□ | 2.2nH ±0.1nH | 500MHz | 14 | 500MHz | 500mA | 0.2Ω | 9.8GHz |
| LQP02HQ2N2C02□ | 2.2nH ±0.2nH | 500MHz | 14 | 500MHz | 500mA | 0.2Ω | 9.8GHz |
| LQP02HQ2N3B02□ | 2.3nH ±0.1nH | 500MHz | 14 | 500MHz | 450mA | 0.2Ω | 9.8GHz |
| LQP02HQ2N3C02□ | 2.3nH ±0.2nH | 500MHz | 14 | 500MHz | 450mA | 0.2Ω | 9.8GHz |
| LQP02HQ2N4B02□ | 2.4nH ±0.1nH | 500MHz | 14 | 500MHz | 450mA | 0.2Ω | 9.5GHz |
| LQP02HQ2N4C02□ | 2.4nH ±0.2nH | 500MHz | 14 | 500MHz | 450mA | 0.2Ω | 9.5GHz |
| LQP02HQ2N5B02□ | 2.5nH ±0.1nH | 500MHz | 14 | 500MHz | 450mA | 0.2Ω | 9.5GHz |
| LQP02HQ2N5C02□ | 2.5nH ±0.2nH | 500MHz | 14 | 500MHz | 450mA | 0.2Ω | 9.5GHz |
| LQP02HQ2N6B02□ | 2.6nH ±0.1nH | 500MHz | 14 | 500MHz | 450mA | 0.2Ω | 9.5GHz |
| LQP02HQ2N6C02□ | 2.6nH ±0.2nH | 500MHz | 14 | 500MHz | 450mA | 0.2Ω | 9.5GHz |
| LQP02HQ2N7B02□ | 2.7nH ±0.1nH | 500MHz | 14 | 500MHz | 450mA | 0.2Ω | 8.8GHz |
| LQP02HQ2N7C02□ | 2.7nH ±0.2nH | 500MHz | 14 | 500MHz | 450mA | 0.2Ω | 8.8GHz |
| LQP02HQ2N8B02□ | 2.8nH ±0.1nH | 500MHz | 14 | 500MHz | 450mA | 0.2Ω | 8.8GHz |
| LQP02HQ2N8C02□ | 2.8nH ±0.2nH | 500MHz | 14 | 500MHz | 450mA | 0.2Ω | 8.8GHz |
| LQP02HQ2N9B02□ | 2.9nH ±0.1nH | 500MHz | 14 | 500MHz | 450mA | 0.2Ω | 8.8GHz |
| LQP02HQ2N9C02□ | 2.9nH ±0.2nH | 500MHz | 14 | 500MHz | 450mA | 0.2Ω | 8.8GHz |
| LQP02HQ3N0B02□ | 3.0nH ±0.1nH | 500MHz | 14 | 500MHz | 450mA | 0.2Ω | 8.5GHz |
| LQP02HQ3N0C02□ | 3.0nH ±0.2nH | 500MHz | 14 | 500MHz | 450mA | 0.2Ω | 8.5GHz |
| LQP02HQ3N1B02□ | 3.1nH ±0.1nH | 500MHz | 14 | 500MHz | 400mA | 0.25Ω | 8.5GHz |
| LQP02HQ3N1C02□ | 3.1nH ±0.2nH | 500MHz | 14 | 500MHz | 400mA | 0.25Ω | 8.5GHz |
| LQP02HQ3N2B02□ | 3.2nH ±0.1nH | 500MHz | 14 | 500MHz | 400mA | 0.25Ω | 8.5GHz |
| LQP02HQ3N2C02□ | 3.2nH ±0.2nH | 500MHz | 14 | 500MHz | 400mA | 0.25Ω | 8.5GHz |
| LQP02HQ3N3B02□ | 3.3nH ±0.1nH | 500MHz | 14 | 500MHz | 400mA | 0.25Ω | 8.2GHz |
| LQP02HQ3N3C02□ | 3.3nH ±0.2nH | 500MHz | 14 | 500MHz | 400mA | 0.25Ω | 8.2GHz |
| LQP02HQ3N4B02□ | 3.4nH ±0.1nH | 500MHz | 14 | 500MHz | 400mA | 0.3Ω | 8.2GHz |
| LQP02HQ3N4C02□ | 3.4nH ±0.2nH | 500MHz | 14 | 500MHz | 400mA | 0.3Ω | 8.2GHz |
| LQP02HQ3N5B02□ | 3.5nH ±0.1nH | 500MHz | 14 | 500MHz | 350mA | 0.3Ω | 8.2GHz |
| LQP02HQ3N5C02□ | 3.5nH ±0.2nH | 500MHz | 14 | 500MHz | 350mA | 0.3Ω | 8.2GHz |
| LQP02HQ3N6B02□ | 3.6nH ±0.1nH | 500MHz | 14 | 500MHz | 350mA | 0.3Ω | 8.2GHz |
| LQP02HQ3N6C02□ | 3.6nH ±0.2nH | 500MHz | 14 | 500MHz | 350mA | 0.3Ω | 8.2GHz |
| LQP02HQ3N7B02□ | 3.7nH ±0.1nH | 500MHz | 14 | 500MHz | 350mA | 0.35Ω | 8.2GHz |
| LQP02HQ3N7C02□ | 3.7nH ±0.2nH | 500MHz | 14 | 500MHz | 350mA | 0.35Ω | 8.2GHz |
| LQP02HQ3N8B02□ | 3.8nH ±0.1nH | 500MHz | 14 | 500MHz | 350mA | 0.35Ω | 8.2GHz |
| LQP02HQ3N8C02□ | 3.8nH ±0.2nH | 500MHz | 14 | 500MHz | 350mA | 0.35Ω | 8.2GHz |
| LQP02HQ3N9B02□ | 3.9nH ±0.1nH | 500MHz | 14 | 500MHz | 350mA | 0.35Ω | 7.7GHz |
| LQP02HQ3N9C02□ | 3.9nH ±0.2nH | 500MHz | 14 | 500MHz | 350mA | 0.35Ω | 7.7GHz |
| LQP02HQ4N0B02□ | 4.0nH ±0.1nH | 500MHz | 14 | 500MHz | 350mA | 0.35Ω | 6.9GHz |
| LQP02HQ4N0C02□ | 4.0nH ±0.2nH | 500MHz | 14 | 500MHz | 350mA | 0.35Ω | 6.9GHz |
| LQP02HQ4N1B02□ | 4.1nH ±0.1nH | 500MHz | 14 | 500MHz | 350mA | 0.35Ω | 6.9GHz |
| LQP02HQ4N1C02□ | 4.1nH ±0.2nH | 500MHz | 14 | 500MHz | 350mA | 0.35Ω | 6.9GHz |
| LQP02HQ4N2B02□ | 4.2nH ±0.1nH | 500MHz | 14 | 500MHz | 350mA | 0.35Ω | 6.9GHz |
| LQP02HQ4N2C02□ | 4.2nH ±0.2nH | 500MHz | 14 | 500MHz | 350mA | 0.35Ω | 6.9GHz |
| LQP02HQ4N3H02□ | 4.3nH ±3% | 500MHz | 13 | 500MHz | 350mA | 0.35Ω | 6.9GHz |
| LQP02HQ4N3J02□ | 4.3nH ±5% | 500MHz | 13 | 500MHz | 350mA | 0.35Ω | 6.9GHz |
| LQP02HQ4N7H02□ | 4.7nH ±3% | 500MHz | 13 | 500MHz | 350mA | 0.35Ω | 6.7GHz |
| LQP02HQ4N7J02□ | 4.7nH ±5% | 500MHz | 13 | 500MHz | 350mA | 0.35Ω | 6.7GHz |
| LQP02HQ5N1H02□ | 5.1nH ±3% | 500MHz | 13 | 500MHz | 350mA | 0.35Ω | 6.6GHz |
| LQP02HQ5N1J02□ | 5.1nH ±5% | 500MHz | 13 | 500MHz | 350mA | 0.35Ω | 6.6GHz |
| LQP02HQ5N6H02□ | 5.6nH ±3% | 500MHz | 13 | 500MHz | 300mA | 0.4Ω | 6.1GHz |
| LQP02HQ5N6J02□ | 5.6nH ±5% | 500MHz | 13 | 500MHz | 300mA | 0.4Ω | 6.1GHz |
| LQP02HQ6N2H02□ | 6.2nH ±3% | 500MHz | 13 | 500MHz | 300mA | 0.4Ω | 6.0GHz |
| LQP02HQ6N2J02□ | 6.2nH ±5% | 500MHz | 13 | 500MHz | 300mA | 0.4Ω | 6.0GHz |

Operating temp. range: -55 to 125°C
 Only for reflow soldering
 *S.R.F.: Self Resonant Frequency

Continued on the following page. ↗

Continued from the preceding page. ↘

| Part Number (□: packaging code) | Inductance | Inductance Test Frequency | Q (min.) | Q Test Frequency | Rated Current | Max. of DC Resistance | S.R.F.* (min.) |
|------------------------------------|------------|------------------------------|----------|------------------|---------------|-----------------------|----------------|
| LQP02HQ6N8H02□ | 6.8nH ±3% | 500MHz | 13 | 500MHz | 300mA | 0.4Ω | 5.7GHz |
| LQP02HQ6N8J02□ | 6.8nH ±5% | 500MHz | 13 | 500MHz | 300mA | 0.4Ω | 5.7GHz |
| LQP02HQ7N5H02□ | 7.5nH ±3% | 500MHz | 13 | 500MHz | 300mA | 0.5Ω | 5.6GHz |
| LQP02HQ7N5J02□ | 7.5nH ±5% | 500MHz | 13 | 500MHz | 300mA | 0.5Ω | 5.6GHz |
| LQP02HQ8N2H02□ | 8.2nH ±3% | 500MHz | 13 | 500MHz | 300mA | 0.5Ω | 5.1GHz |
| LQP02HQ8N2J02□ | 8.2nH ±5% | 500MHz | 13 | 500MHz | 300mA | 0.5Ω | 5.1GHz |
| LQP02HQ9N1H02□ | 9.1nH ±3% | 500MHz | 13 | 500MHz | 300mA | 0.5Ω | 4.9GHz |
| LQP02HQ9N1J02□ | 9.1nH ±5% | 500MHz | 13 | 500MHz | 300mA | 0.5Ω | 4.9GHz |
| LQP02HQ10NH02□ | 10nH ±3% | 500MHz | 13 | 500MHz | 250mA | 0.6Ω | 4.9GHz |
| LQP02HQ10NJ02□ | 10nH ±5% | 500MHz | 13 | 500MHz | 250mA | 0.6Ω | 4.9GHz |
| LQP02HQ11NH02□ | 11nH ±3% | 500MHz | 13 | 500MHz | 250mA | 0.8Ω | 4.0GHz |
| LQP02HQ11NJ02□ | 11nH ±5% | 500MHz | 13 | 500MHz | 250mA | 0.8Ω | 4.0GHz |
| LQP02HQ12NH02□ | 12nH ±3% | 500MHz | 13 | 500MHz | 230mA | 0.82Ω | 4.0GHz |
| LQP02HQ12NJ02□ | 12nH ±5% | 500MHz | 13 | 500MHz | 230mA | 0.82Ω | 4.0GHz |
| LQP02HQ13NH02□ | 13nH ±3% | 500MHz | 13 | 500MHz | 210mA | 0.99Ω | 4.0GHz |
| LQP02HQ13NJ02□ | 13nH ±5% | 500MHz | 13 | 500MHz | 210mA | 0.99Ω | 4.0GHz |
| LQP02HQ15NH02□ | 15nH ±3% | 500MHz | 13 | 500MHz | 170mA | 1.53Ω | 4.0GHz |
| LQP02HQ15NJ02□ | 15nH ±5% | 500MHz | 13 | 500MHz | 170mA | 1.53Ω | 4.0GHz |
| LQP02HQ16NH02□ | 16nH ±3% | 500MHz | 13 | 500MHz | 170mA | 1.53Ω | 4.0GHz |
| LQP02HQ16NJ02□ | 16nH ±5% | 500MHz | 13 | 500MHz | 170mA | 1.53Ω | 4.0GHz |
| LQP02HQ18NH02□ | 18nH ±3% | 500MHz | 13 | 500MHz | 160mA | 1.63Ω | 3.7GHz |
| LQP02HQ18NJ02□ | 18nH ±5% | 500MHz | 13 | 500MHz | 160mA | 1.63Ω | 3.7GHz |
| LQP02HQ20NH02□ | 20nH ±3% | 500MHz | 12 | 500MHz | 140mA | 2.26Ω | 3.0GHz |
| LQP02HQ20NJ02□ | 20nH ±5% | 500MHz | 12 | 500MHz | 140mA | 2.26Ω | 3.0GHz |
| LQP02HQ22NH02□ | 22nH ±3% | 500MHz | 12 | 500MHz | 140mA | 2.26Ω | 3.0GHz |
| LQP02HQ22NJ02□ | 22nH ±5% | 500MHz | 12 | 500MHz | 140mA | 2.26Ω | 3.0GHz |
| LQP02HQ24NH02□ | 24nH ±3% | 500MHz | 12 | 500MHz | 120mA | 2.6Ω | 2.9GHz |
| LQP02HQ24NJ02□ | 24nH ±5% | 500MHz | 12 | 500MHz | 120mA | 2.6Ω | 2.9GHz |
| LQP02HQ27NH02□ | 27nH ±3% | 500MHz | 12 | 500MHz | 120mA | 2.6Ω | 2.9GHz |
| LQP02HQ27NJ02□ | 27nH ±5% | 500MHz | 12 | 500MHz | 120mA | 2.6Ω | 2.9GHz |
| LQP02HQ30NH02□ | 30nH ±3% | 500MHz | 9 | 500MHz | 120mA | 3.2Ω | 2.6GHz |
| LQP02HQ30NJ02□ | 30nH ±5% | 500MHz | 9 | 500MHz | 120mA | 3.2Ω | 2.6GHz |
| LQP02HQ33NH02□ | 33nH ±3% | 300MHz | 9 | 300MHz | 120mA | 3.2Ω | 2.6GHz |
| LQP02HQ33NJ02□ | 33nH ±5% | 300MHz | 9 | 300MHz | 120mA | 3.2Ω | 2.6GHz |
| LQP02HQ36NH02□ | 36nH ±3% | 300MHz | 9 | 300MHz | 110mA | 3.6Ω | 2.4GHz |
| LQP02HQ36NJ02□ | 36nH ±5% | 300MHz | 9 | 300MHz | 110mA | 3.6Ω | 2.4GHz |
| LQP02HQ39NH02□ | 39nH ±3% | 300MHz | 9 | 300MHz | 110mA | 3.6Ω | 2.4GHz |
| LQP02HQ39NJ02□ | 39nH ±5% | 300MHz | 9 | 300MHz | 110mA | 3.6Ω | 2.4GHz |
| LQP02HQ43NH02□ | 43nH ±3% | 300MHz | 8 | 300MHz | 100mA | 4.0Ω | 2.1GHz |
| LQP02HQ43NJ02□ | 43nH ±5% | 300MHz | 8 | 300MHz | 100mA | 4.0Ω | 2.1GHz |
| LQP02HQ47NH02□ | 47nH ±3% | 300MHz | 8 | 300MHz | 100mA | 4.0Ω | 2.1GHz |
| LQP02HQ47NJ02□ | 47nH ±5% | 300MHz | 8 | 300MHz | 100mA | 4.0Ω | 2.1GHz |
| LQP02HQ51NH02□ | 51nH ±3% | 300MHz | 8 | 300MHz | 100mA | 4.2Ω | 1.9GHz |
| LQP02HQ51NJ02□ | 51nH ±5% | 300MHz | 8 | 300MHz | 100mA | 4.2Ω | 1.9GHz |
| LQP02HQ56NH02□ | 56nH ±3% | 300MHz | 8 | 300MHz | 100mA | 4.2Ω | 1.9GHz |
| LQP02HQ56NJ02□ | 56nH ±5% | 300MHz | 8 | 300MHz | 100mA | 4.2Ω | 1.9GHz |

Operating temp. range: -55 to 125°C

Only for reflow soldering

*S.R.F.: Self Resonant Frequency

Continued on the following page. ↗

Continued from the preceding page. ↘

Inductance-Frequency Characteristics (Typ.)



Q-Frequency Characteristics (Typ.)



LQP02TN_02 Series 01005 (0402) inch (mm)



| Packaging Code | Packaging | Minimum Quantity |
|----------------|------------------------|------------------|
| D | ø180mm Paper Taping | 20000 |
| L | ø180mm Embossed Taping | 40000 |
| B | Packing in Bulk | 500 |

| Part Number (□: packaging code) | Inductance | Inductance Test Frequency | Q (min.) | Q Test Frequency | Rated Current | Max. of DC Resistance | S.R.F.* (min.) |
|------------------------------------|--------------|---------------------------|----------|------------------|---------------|-----------------------|----------------|
| LQP02TN0N2B02□ | 0.2nH ±0.1nH | 500MHz | - | 500MHz | 320mA | 0.50Ω | 20000MHz |
| LQP02TN0N2C02□ | 0.2nH ±0.2nH | 500MHz | - | 500MHz | 320mA | 0.50Ω | 20000MHz |
| LQP02TN0N3B02□ | 0.3nH ±0.1nH | 500MHz | - | 500MHz | 320mA | 0.50Ω | 20000MHz |
| LQP02TN0N3C02□ | 0.3nH ±0.2nH | 500MHz | - | 500MHz | 320mA | 0.50Ω | 20000MHz |
| LQP02TN0N4B02□ | 0.4nH ±0.1nH | 500MHz | 8 | 500MHz | 320mA | 0.50Ω | 18000MHz |
| LQP02TN0N4C02□ | 0.4nH ±0.2nH | 500MHz | 8 | 500MHz | 320mA | 0.50Ω | 18000MHz |
| LQP02TN0N5B02□ | 0.5nH ±0.1nH | 500MHz | 8 | 500MHz | 320mA | 0.50Ω | 18000MHz |
| LQP02TN0N5C02□ | 0.5nH ±0.2nH | 500MHz | 8 | 500MHz | 320mA | 0.50Ω | 18000MHz |
| LQP02TN0N6B02□ | 0.6nH ±0.1nH | 500MHz | 8 | 500MHz | 320mA | 0.50Ω | 17000MHz |
| LQP02TN0N6C02□ | 0.6nH ±0.2nH | 500MHz | 8 | 500MHz | 320mA | 0.50Ω | 17000MHz |
| LQP02TN0N7B02□ | 0.7nH ±0.1nH | 500MHz | 8 | 500MHz | 320mA | 0.50Ω | 16500MHz |
| LQP02TN0N7C02□ | 0.7nH ±0.2nH | 500MHz | 8 | 500MHz | 320mA | 0.50Ω | 16500MHz |
| LQP02TN0N8B02□ | 0.8nH ±0.1nH | 500MHz | 8 | 500MHz | 320mA | 0.50Ω | 16500MHz |
| LQP02TN0N8C02□ | 0.8nH ±0.2nH | 500MHz | 8 | 500MHz | 320mA | 0.50Ω | 16500MHz |
| LQP02TN0N9B02□ | 0.9nH ±0.1nH | 500MHz | 8 | 500MHz | 320mA | 0.50Ω | 13000MHz |
| LQP02TN0N9C02□ | 0.9nH ±0.2nH | 500MHz | 8 | 500MHz | 320mA | 0.50Ω | 13000MHz |
| LQP02TN1N0B02□ | 1.0nH ±0.1nH | 500MHz | 8 | 500MHz | 220mA | 0.60Ω | 13000MHz |
| LQP02TN1N0C02□ | 1.0nH ±0.2nH | 500MHz | 8 | 500MHz | 220mA | 0.60Ω | 13000MHz |
| LQP02TN1N1B02□ | 1.1nH ±0.1nH | 500MHz | 8 | 500MHz | 220mA | 0.60Ω | 12500MHz |
| LQP02TN1N1C02□ | 1.1nH ±0.2nH | 500MHz | 8 | 500MHz | 220mA | 0.60Ω | 12500MHz |
| LQP02TN1N2B02□ | 1.2nH ±0.1nH | 500MHz | 8 | 500MHz | 220mA | 0.60Ω | 12500MHz |
| LQP02TN1N2C02□ | 1.2nH ±0.2nH | 500MHz | 8 | 500MHz | 220mA | 0.60Ω | 12500MHz |
| LQP02TN1N3B02□ | 1.3nH ±0.1nH | 500MHz | 8 | 500MHz | 220mA | 0.60Ω | 11500MHz |
| LQP02TN1N3C02□ | 1.3nH ±0.2nH | 500MHz | 8 | 500MHz | 220mA | 0.60Ω | 11500MHz |
| LQP02TN1N4B02□ | 1.4nH ±0.1nH | 500MHz | 8 | 500MHz | 220mA | 0.60Ω | 11500MHz |
| LQP02TN1N4C02□ | 1.4nH ±0.2nH | 500MHz | 8 | 500MHz | 220mA | 0.60Ω | 11500MHz |

Operating temp. range: -55 to 125°C

Only for reflow soldering

*S.R.F.: Self Resonant Frequency

Continued on the following page. ↗

Continued from the preceding page. ↘

| Part Number (□: packaging code) | Inductance | Inductance Test Frequency | Q (min.) | Q Test Frequency | Rated Current | Max. of DC Resistance | S.R.F.* (min.) |
|------------------------------------|--------------|------------------------------|----------|------------------|---------------|-----------------------|----------------|
| LQP02TN1N5B02□ | 1.5nH ±0.1nH | 500MHz | 8 | 500MHz | 220mA | 0.60Ω | 9500MHz |
| LQP02TN1N5C02□ | 1.5nH ±0.2nH | 500MHz | 8 | 500MHz | 220mA | 0.60Ω | 9500MHz |
| LQP02TN1N6B02□ | 1.6nH ±0.1nH | 500MHz | 8 | 500MHz | 220mA | 0.60Ω | 9500MHz |
| LQP02TN1N6C02□ | 1.6nH ±0.2nH | 500MHz | 8 | 500MHz | 220mA | 0.60Ω | 9500MHz |
| LQP02TN1N7B02□ | 1.7nH ±0.1nH | 500MHz | 8 | 500MHz | 200mA | 0.70Ω | 9500MHz |
| LQP02TN1N7C02□ | 1.7nH ±0.2nH | 500MHz | 8 | 500MHz | 200mA | 0.70Ω | 9500MHz |
| LQP02TN1N8B02□ | 1.8nH ±0.1nH | 500MHz | 8 | 500MHz | 200mA | 0.70Ω | 9000MHz |
| LQP02TN1N8C02□ | 1.8nH ±0.2nH | 500MHz | 8 | 500MHz | 200mA | 0.70Ω | 9000MHz |
| LQP02TN1N9B02□ | 1.9nH ±0.1nH | 500MHz | 8 | 500MHz | 200mA | 0.75Ω | 9000MHz |
| LQP02TN1N9C02□ | 1.9nH ±0.2nH | 500MHz | 8 | 500MHz | 200mA | 0.75Ω | 9000MHz |
| LQP02TN2N0B02□ | 2.0nH ±0.1nH | 500MHz | 8 | 500MHz | 200mA | 0.75Ω | 9000MHz |
| LQP02TN2N0C02□ | 2.0nH ±0.2nH | 500MHz | 8 | 500MHz | 200mA | 0.75Ω | 9000MHz |
| LQP02TN2N1B02□ | 2.1nH ±0.1nH | 500MHz | 8 | 500MHz | 200mA | 0.75Ω | 9000MHz |
| LQP02TN2N1C02□ | 2.1nH ±0.2nH | 500MHz | 8 | 500MHz | 200mA | 0.75Ω | 9000MHz |
| LQP02TN2N2B02□ | 2.2nH ±0.1nH | 500MHz | 8 | 500MHz | 200mA | 0.75Ω | 7500MHz |
| LQP02TN2N2C02□ | 2.2nH ±0.2nH | 500MHz | 8 | 500MHz | 200mA | 0.75Ω | 7500MHz |
| LQP02TN2N3B02□ | 2.3nH ±0.1nH | 500MHz | 8 | 500MHz | 200mA | 0.75Ω | 7500MHz |
| LQP02TN2N3C02□ | 2.3nH ±0.2nH | 500MHz | 8 | 500MHz | 200mA | 0.75Ω | 7500MHz |
| LQP02TN2N4B02□ | 2.4nH ±0.1nH | 500MHz | 8 | 500MHz | 200mA | 0.75Ω | 7500MHz |
| LQP02TN2N4C02□ | 2.4nH ±0.2nH | 500MHz | 8 | 500MHz | 200mA | 0.75Ω | 7500MHz |
| LQP02TN2N5B02□ | 2.5nH ±0.1nH | 500MHz | 8 | 500MHz | 200mA | 0.80Ω | 7500MHz |
| LQP02TN2N5C02□ | 2.5nH ±0.2nH | 500MHz | 8 | 500MHz | 200mA | 0.80Ω | 7500MHz |
| LQP02TN2N6B02□ | 2.6nH ±0.1nH | 500MHz | 8 | 500MHz | 200mA | 0.80Ω | 7500MHz |
| LQP02TN2N6C02□ | 2.6nH ±0.2nH | 500MHz | 8 | 500MHz | 200mA | 0.80Ω | 7500MHz |
| LQP02TN2N7B02□ | 2.7nH ±0.1nH | 500MHz | 8 | 500MHz | 200mA | 0.80Ω | 7500MHz |
| LQP02TN2N7C02□ | 2.7nH ±0.2nH | 500MHz | 8 | 500MHz | 200mA | 0.80Ω | 7500MHz |
| LQP02TN2N8B02□ | 2.8nH ±0.1nH | 500MHz | 8 | 500MHz | 200mA | 1.10Ω | 7500MHz |
| LQP02TN2N8C02□ | 2.8nH ±0.2nH | 500MHz | 8 | 500MHz | 200mA | 1.10Ω | 7500MHz |
| LQP02TN2N9B02□ | 2.9nH ±0.1nH | 500MHz | 8 | 500MHz | 200mA | 1.10Ω | 7500MHz |
| LQP02TN2N9C02□ | 2.9nH ±0.2nH | 500MHz | 8 | 500MHz | 200mA | 1.10Ω | 7500MHz |
| LQP02TN3N0B02□ | 3.0nH ±0.1nH | 500MHz | 8 | 500MHz | 200mA | 1.10Ω | 7500MHz |
| LQP02TN3N0C02□ | 3.0nH ±0.2nH | 500MHz | 8 | 500MHz | 200mA | 1.10Ω | 7500MHz |
| LQP02TN3N1B02□ | 3.1nH ±0.1nH | 500MHz | 8 | 500MHz | 180mA | 1.30Ω | 7500MHz |
| LQP02TN3N1C02□ | 3.1nH ±0.2nH | 500MHz | 8 | 500MHz | 180mA | 1.30Ω | 7500MHz |
| LQP02TN3N2B02□ | 3.2nH ±0.1nH | 500MHz | 8 | 500MHz | 180mA | 1.30Ω | 7500MHz |
| LQP02TN3N2C02□ | 3.2nH ±0.2nH | 500MHz | 8 | 500MHz | 180mA | 1.30Ω | 7500MHz |
| LQP02TN3N3B02□ | 3.3nH ±0.1nH | 500MHz | 8 | 500MHz | 180mA | 1.30Ω | 7500MHz |
| LQP02TN3N3C02□ | 3.3nH ±0.2nH | 500MHz | 8 | 500MHz | 180mA | 1.30Ω | 7500MHz |
| LQP02TN3N4B02□ | 3.4nH ±0.1nH | 500MHz | 8 | 500MHz | 180mA | 1.30Ω | 7500MHz |
| LQP02TN3N4C02□ | 3.4nH ±0.2nH | 500MHz | 8 | 500MHz | 180mA | 1.30Ω | 7500MHz |
| LQP02TN3N5B02□ | 3.5nH ±0.1nH | 500MHz | 8 | 500MHz | 180mA | 1.30Ω | 7500MHz |
| LQP02TN3N5C02□ | 3.5nH ±0.2nH | 500MHz | 8 | 500MHz | 180mA | 1.30Ω | 7500MHz |
| LQP02TN3N6B02□ | 3.6nH ±0.1nH | 500MHz | 8 | 500MHz | 180mA | 1.30Ω | 7500MHz |
| LQP02TN3N6C02□ | 3.6nH ±0.2nH | 500MHz | 8 | 500MHz | 180mA | 1.30Ω | 7500MHz |
| LQP02TN3N7B02□ | 3.7nH ±0.1nH | 500MHz | 8 | 500MHz | 180mA | 1.30Ω | 7500MHz |
| LQP02TN3N7C02□ | 3.7nH ±0.2nH | 500MHz | 8 | 500MHz | 180mA | 1.30Ω | 7500MHz |
| LQP02TN3N8B02□ | 3.8nH ±0.1nH | 500MHz | 8 | 500MHz | 180mA | 1.30Ω | 7500MHz |
| LQP02TN3N8C02□ | 3.8nH ±0.2nH | 500MHz | 8 | 500MHz | 180mA | 1.30Ω | 7500MHz |
| LQP02TN3N9B02□ | 3.9nH ±0.1nH | 500MHz | 8 | 500MHz | 180mA | 1.30Ω | 7500MHz |
| LQP02TN3N9C02□ | 3.9nH ±0.2nH | 500MHz | 8 | 500MHz | 180mA | 1.30Ω | 7500MHz |
| LQP02TN4N0B02□ | 4.0nH ±0.1nH | 500MHz | 8 | 500MHz | 180mA | 1.30Ω | 7500MHz |
| LQP02TN4N0C02□ | 4.0nH ±0.2nH | 500MHz | 8 | 500MHz | 180mA | 1.30Ω | 7500MHz |
| LQP02TN4N1B02□ | 4.1nH ±0.1nH | 500MHz | 8 | 500MHz | 180mA | 1.30Ω | 7500MHz |

Operating temp. range: -55 to 125°C
 Only for reflow soldering
 *S.R.F.: Self Resonant Frequency

Continued on the following page. ↗

Inductors for Power Lines

Inductors for General Circuits

RF Inductors
 LQP02TN_02

Continued from the preceding page. ↘

| Part Number (□: packaging code) | Inductance | Inductance Test Frequency | Q (min.) | Q Test Frequency | Rated Current | Max. of DC Resistance | S.R.F.* (min.) |
|------------------------------------|--------------|------------------------------|----------|------------------|---------------|-----------------------|----------------|
| LQP02TN4N1C02□ | 4.1nH ±0.2nH | 500MHz | 8 | 500MHz | 180mA | 1.30Ω | 7500MHz |
| LQP02TN4N2B02□ | 4.2nH ±0.1nH | 500MHz | 8 | 500MHz | 180mA | 1.30Ω | 7000MHz |
| LQP02TN4N2C02□ | 4.2nH ±0.2nH | 500MHz | 8 | 500MHz | 180mA | 1.30Ω | 7000MHz |
| LQP02TN4N3H02□ | 4.3nH ±3% | 500MHz | 8 | 500MHz | 180mA | 1.30Ω | 7000MHz |
| LQP02TN4N3J02□ | 4.3nH ±5% | 500MHz | 8 | 500MHz | 180mA | 1.30Ω | 7000MHz |
| LQP02TN4N7H02□ | 4.7nH ±3% | 500MHz | 8 | 500MHz | 160mA | 1.50Ω | 6500MHz |
| LQP02TN4N7J02□ | 4.7nH ±5% | 500MHz | 8 | 500MHz | 160mA | 1.50Ω | 6500MHz |
| LQP02TN5N1H02□ | 5.1nH ±3% | 500MHz | 8 | 500MHz | 160mA | 1.50Ω | 6500MHz |
| LQP02TN5N1J02□ | 5.1nH ±5% | 500MHz | 8 | 500MHz | 160mA | 1.50Ω | 6500MHz |
| LQP02TN5N6H02□ | 5.6nH ±3% | 500MHz | 8 | 500MHz | 140mA | 1.80Ω | 6000MHz |
| LQP02TN5N6J02□ | 5.6nH ±5% | 500MHz | 8 | 500MHz | 140mA | 1.80Ω | 6000MHz |
| LQP02TN6N2H02□ | 6.2nH ±3% | 500MHz | 8 | 500MHz | 140mA | 1.80Ω | 5500MHz |
| LQP02TN6N2J02□ | 6.2nH ±5% | 500MHz | 8 | 500MHz | 140mA | 1.80Ω | 5500MHz |
| LQP02TN6N8H02□ | 6.8nH ±3% | 500MHz | 8 | 500MHz | 140mA | 2.00Ω | 5500MHz |
| LQP02TN6N8J02□ | 6.8nH ±5% | 500MHz | 8 | 500MHz | 140mA | 2.00Ω | 5500MHz |
| LQP02TN7N5H02□ | 7.5nH ±3% | 500MHz | 8 | 500MHz | 140mA | 2.00Ω | 4500MHz |
| LQP02TN7N5J02□ | 7.5nH ±5% | 500MHz | 8 | 500MHz | 140mA | 2.00Ω | 4500MHz |
| LQP02TN8N2H02□ | 8.2nH ±3% | 500MHz | 8 | 500MHz | 140mA | 2.10Ω | 4500MHz |
| LQP02TN8N2J02□ | 8.2nH ±5% | 500MHz | 8 | 500MHz | 140mA | 2.10Ω | 4500MHz |
| LQP02TN9N1H02□ | 9.1nH ±3% | 500MHz | 8 | 500MHz | 140mA | 2.10Ω | 4000MHz |
| LQP02TN9N1J02□ | 9.1nH ±5% | 500MHz | 8 | 500MHz | 140mA | 2.10Ω | 4000MHz |
| LQP02TN10NH02□ | 10nH ±3% | 500MHz | 8 | 500MHz | 140mA | 2.50Ω | 4000MHz |
| LQP02TN10NJ02□ | 10nH ±5% | 500MHz | 8 | 500MHz | 140mA | 2.50Ω | 4000MHz |
| LQP02TN11NH02□ | 11nH ±3% | 500MHz | 7 | 500MHz | 140mA | 2.80Ω | 3500MHz |
| LQP02TN11NJ02□ | 11nH ±5% | 500MHz | 7 | 500MHz | 140mA | 2.80Ω | 3500MHz |
| LQP02TN12NH02□ | 12nH ±3% | 500MHz | 7 | 500MHz | 140mA | 2.80Ω | 3500MHz |
| LQP02TN12NJ02□ | 12nH ±5% | 500MHz | 7 | 500MHz | 140mA | 2.80Ω | 3500MHz |
| LQP02TN13NH02□ | 13nH ±3% | 500MHz | 7 | 500MHz | 140mA | 3.20Ω | 3000MHz |
| LQP02TN13NJ02□ | 13nH ±5% | 500MHz | 7 | 500MHz | 140mA | 3.20Ω | 3000MHz |
| LQP02TN15NH02□ | 15nH ±3% | 500MHz | 7 | 500MHz | 140mA | 3.20Ω | 3000MHz |
| LQP02TN15NJ02□ | 15nH ±5% | 500MHz | 7 | 500MHz | 140mA | 3.20Ω | 3000MHz |
| LQP02TN16NH02□ | 16nH ±3% | 500MHz | 7 | 500MHz | 140mA | 3.50Ω | 2500MHz |
| LQP02TN16NJ02□ | 16nH ±5% | 500MHz | 7 | 500MHz | 140mA | 3.50Ω | 2500MHz |
| LQP02TN18NH02□ | 18nH ±3% | 500MHz | 7 | 500MHz | 140mA | 3.50Ω | 2500MHz |
| LQP02TN18NJ02□ | 18nH ±5% | 500MHz | 7 | 500MHz | 140mA | 3.50Ω | 2500MHz |
| LQP02TN20NH02□ | 20nH ±3% | 500MHz | 6 | 500MHz | 120mA | 5.00Ω | 2300MHz |
| LQP02TN20NJ02□ | 20nH ±5% | 500MHz | 6 | 500MHz | 120mA | 5.00Ω | 2300MHz |
| LQP02TN22NH02□ | 22nH ±3% | 500MHz | 6 | 500MHz | 120mA | 5.00Ω | 2300MHz |
| LQP02TN22NJ02□ | 22nH ±5% | 500MHz | 6 | 500MHz | 120mA | 5.00Ω | 2300MHz |
| LQP02TN24NH02□ | 24nH ±3% | 500MHz | 6 | 500MHz | 120mA | 5.50Ω | 2000MHz |
| LQP02TN24NJ02□ | 24nH ±5% | 500MHz | 6 | 500MHz | 120mA | 5.50Ω | 2000MHz |
| LQP02TN27NH02□ | 27nH ±3% | 500MHz | 6 | 500MHz | 120mA | 5.50Ω | 2000MHz |
| LQP02TN27NJ02□ | 27nH ±5% | 500MHz | 6 | 500MHz | 120mA | 5.50Ω | 2000MHz |
| LQP02TN30NH02□ | 30nH ±3% | 500MHz | 6 | 500MHz | 90mA | 6.50Ω | 1800MHz |
| LQP02TN30NJ02□ | 30nH ±5% | 500MHz | 6 | 500MHz | 90mA | 6.50Ω | 1800MHz |
| LQP02TN33NH02□ | 33nH ±3% | 300MHz | 4 | 300MHz | 90mA | 6.50Ω | 1800MHz |
| LQP02TN33NJ02□ | 33nH ±5% | 300MHz | 4 | 300MHz | 90mA | 6.50Ω | 1800MHz |
| LQP02TN36NH02□ | 36nH ±3% | 300MHz | 4 | 300MHz | 90mA | 7.00Ω | 1600MHz |
| LQP02TN36NJ02□ | 36nH ±5% | 300MHz | 4 | 300MHz | 90mA | 7.00Ω | 1600MHz |
| LQP02TN39NH02□ | 39nH ±3% | 300MHz | 4 | 300MHz | 90mA | 7.00Ω | 1600MHz |
| LQP02TN39NJ02□ | 39nH ±5% | 300MHz | 4 | 300MHz | 90mA | 7.00Ω | 1600MHz |

Operating temp. range: -55 to 125°C

Only for reflow soldering

*S.R.F.: Self Resonant Frequency

Continued on the following page. ↗

Inductors for Power Lines

Inductors for General Circuits

LQP02TN_02
RF Inductors

Continued from the preceding page. ↘

Inductance-Frequency Characteristics (Typ.)



Q-Frequency Characteristics (Typ.)



LQP02TQ_02 Series 01005 (0402) inch (mm)



| Packaging Code | Packaging | Minimum Quantity |
|----------------|------------------------|------------------|
| D | ø180mm Paper Taping | 20000 |
| L | ø180mm Embossed Taping | 40000 |
| B | Packing in Bulk | 500 |

| Part Number (□: packaging code) | Inductance | Inductance Test Frequency | Q (min.) | Q Test Frequency | Rated Current | Max. of DC Resistance | S.R.F.* (min.) |
|------------------------------------|--------------|---------------------------|----------|------------------|---------------|-----------------------|----------------|
| LQP02TQ0N2B02□ | 0.2nH ±0.1nH | 500MHz | - | 500MHz | 990mA | 0.1Ω | 16.6GHz |
| LQP02TQ0N2C02□ | 0.2nH ±0.2nH | 500MHz | - | 500MHz | 990mA | 0.1Ω | 16.6GHz |
| LQP02TQ0N3B02□ | 0.3nH ±0.1nH | 500MHz | - | 500MHz | 990mA | 0.1Ω | 16.6GHz |
| LQP02TQ0N3C02□ | 0.3nH ±0.2nH | 500MHz | - | 500MHz | 990mA | 0.1Ω | 16.6GHz |
| LQP02TQ0N4B02□ | 0.4nH ±0.1nH | 500MHz | 10 | 500MHz | 990mA | 0.1Ω | 16.6GHz |
| LQP02TQ0N4C02□ | 0.4nH ±0.2nH | 500MHz | 10 | 500MHz | 990mA | 0.1Ω | 16.6GHz |
| LQP02TQ0N5B02□ | 0.5nH ±0.1nH | 500MHz | 10 | 500MHz | 730mA | 0.1Ω | 16.6GHz |
| LQP02TQ0N5C02□ | 0.5nH ±0.2nH | 500MHz | 10 | 500MHz | 730mA | 0.1Ω | 16.6GHz |
| LQP02TQ0N6B02□ | 0.6nH ±0.1nH | 500MHz | 10 | 500MHz | 730mA | 0.1Ω | 16.6GHz |
| LQP02TQ0N6C02□ | 0.6nH ±0.2nH | 500MHz | 10 | 500MHz | 730mA | 0.1Ω | 16.6GHz |
| LQP02TQ0N7B02□ | 0.7nH ±0.1nH | 500MHz | 10 | 500MHz | 630mA | 0.15Ω | 16.6GHz |
| LQP02TQ0N7C02□ | 0.7nH ±0.2nH | 500MHz | 10 | 500MHz | 630mA | 0.15Ω | 16.6GHz |
| LQP02TQ0N8B02□ | 0.8nH ±0.1nH | 500MHz | 10 | 500MHz | 630mA | 0.15Ω | 16.6GHz |
| LQP02TQ0N8C02□ | 0.8nH ±0.2nH | 500MHz | 10 | 500MHz | 630mA | 0.15Ω | 16.6GHz |
| LQP02TQ0N9B02□ | 0.9nH ±0.1nH | 500MHz | 10 | 500MHz | 580mA | 0.15Ω | 16.6GHz |
| LQP02TQ0N9C02□ | 0.9nH ±0.2nH | 500MHz | 10 | 500MHz | 580mA | 0.15Ω | 16.6GHz |
| LQP02TQ1N0B02□ | 1.0nH ±0.1nH | 500MHz | 10 | 500MHz | 580mA | 0.15Ω | 16.6GHz |
| LQP02TQ1N0C02□ | 1.0nH ±0.2nH | 500MHz | 10 | 500MHz | 580mA | 0.15Ω | 16.6GHz |
| LQP02TQ1N1B02□ | 1.1nH ±0.1nH | 500MHz | 10 | 500MHz | 570mA | 0.2Ω | 16.6GHz |
| LQP02TQ1N1C02□ | 1.1nH ±0.2nH | 500MHz | 10 | 500MHz | 570mA | 0.2Ω | 16.6GHz |
| LQP02TQ1N2B02□ | 1.2nH ±0.1nH | 500MHz | 10 | 500MHz | 550mA | 0.2Ω | 16.6GHz |
| LQP02TQ1N2C02□ | 1.2nH ±0.2nH | 500MHz | 10 | 500MHz | 550mA | 0.2Ω | 16.6GHz |
| LQP02TQ1N3B02□ | 1.3nH ±0.1nH | 500MHz | 10 | 500MHz | 400mA | 0.2Ω | 15.0GHz |
| LQP02TQ1N3C02□ | 1.3nH ±0.2nH | 500MHz | 10 | 500MHz | 400mA | 0.2Ω | 15.0GHz |
| LQP02TQ1N4B02□ | 1.4nH ±0.1nH | 500MHz | 10 | 500MHz | 400mA | 0.2Ω | 15.0GHz |
| LQP02TQ1N4C02□ | 1.4nH ±0.2nH | 500MHz | 10 | 500MHz | 400mA | 0.2Ω | 15.0GHz |

Operating temp. range: -55 to 125°C
 Only for reflow soldering
 *S.R.F.: Self Resonant Frequency

Continued from the preceding page. ↘

| Part Number (□: packaging code) | Inductance | Inductance Test Frequency | Q (min.) | Q Test Frequency | Rated Current | Max. of DC Resistance | S.R.F.* (min.) |
|------------------------------------|--------------|------------------------------|----------|------------------|---------------|-----------------------|----------------|
| LQP02TQ1N5B02□ | 1.5nH ±0.1nH | 500MHz | 10 | 500MHz | 400mA | 0.2Ω | 15.0GHz |
| LQP02TQ1N5C02□ | 1.5nH ±0.2nH | 500MHz | 10 | 500MHz | 400mA | 0.2Ω | 15.0GHz |
| LQP02TQ1N6B02□ | 1.6nH ±0.1nH | 500MHz | 10 | 500MHz | 390mA | 0.3Ω | 15.0GHz |
| LQP02TQ1N6C02□ | 1.6nH ±0.2nH | 500MHz | 10 | 500MHz | 390mA | 0.3Ω | 15.0GHz |
| LQP02TQ1N7B02□ | 1.7nH ±0.1nH | 500MHz | 10 | 500MHz | 380mA | 0.3Ω | 15.0GHz |
| LQP02TQ1N7C02□ | 1.7nH ±0.2nH | 500MHz | 10 | 500MHz | 380mA | 0.3Ω | 15.0GHz |
| LQP02TQ1N8B02□ | 1.8nH ±0.1nH | 500MHz | 10 | 500MHz | 380mA | 0.3Ω | 15.0GHz |
| LQP02TQ1N8C02□ | 1.8nH ±0.2nH | 500MHz | 10 | 500MHz | 380mA | 0.3Ω | 15.0GHz |
| LQP02TQ1N9B02□ | 1.9nH ±0.1nH | 500MHz | 10 | 500MHz | 380mA | 0.3Ω | 13.0GHz |
| LQP02TQ1N9C02□ | 1.9nH ±0.2nH | 500MHz | 10 | 500MHz | 380mA | 0.3Ω | 13.0GHz |
| LQP02TQ2N0B02□ | 2.0nH ±0.1nH | 500MHz | 10 | 500MHz | 380mA | 0.3Ω | 13.0GHz |
| LQP02TQ2N0C02□ | 2.0nH ±0.2nH | 500MHz | 10 | 500MHz | 380mA | 0.3Ω | 13.0GHz |
| LQP02TQ2N1B02□ | 2.1nH ±0.1nH | 500MHz | 10 | 500MHz | 380mA | 0.3Ω | 13.0GHz |
| LQP02TQ2N1C02□ | 2.1nH ±0.2nH | 500MHz | 10 | 500MHz | 380mA | 0.3Ω | 13.0GHz |
| LQP02TQ2N2B02□ | 2.2nH ±0.1nH | 500MHz | 10 | 500MHz | 380mA | 0.3Ω | 13.0GHz |
| LQP02TQ2N2C02□ | 2.2nH ±0.2nH | 500MHz | 10 | 500MHz | 380mA | 0.3Ω | 13.0GHz |
| LQP02TQ2N3B02□ | 2.3nH ±0.1nH | 500MHz | 10 | 500MHz | 370mA | 0.4Ω | 13.0GHz |
| LQP02TQ2N3C02□ | 2.3nH ±0.2nH | 500MHz | 10 | 500MHz | 370mA | 0.4Ω | 13.0GHz |
| LQP02TQ2N4B02□ | 2.4nH ±0.1nH | 500MHz | 10 | 500MHz | 370mA | 0.4Ω | 13.0GHz |
| LQP02TQ2N4C02□ | 2.4nH ±0.2nH | 500MHz | 10 | 500MHz | 370mA | 0.4Ω | 13.0GHz |
| LQP02TQ2N5B02□ | 2.5nH ±0.1nH | 500MHz | 10 | 500MHz | 370mA | 0.4Ω | 11.5GHz |
| LQP02TQ2N5C02□ | 2.5nH ±0.2nH | 500MHz | 10 | 500MHz | 370mA | 0.4Ω | 11.5GHz |
| LQP02TQ2N6B02□ | 2.6nH ±0.1nH | 500MHz | 10 | 500MHz | 370mA | 0.4Ω | 11.5GHz |
| LQP02TQ2N6C02□ | 2.6nH ±0.2nH | 500MHz | 10 | 500MHz | 370mA | 0.4Ω | 11.5GHz |
| LQP02TQ2N7B02□ | 2.7nH ±0.1nH | 500MHz | 10 | 500MHz | 370mA | 0.4Ω | 11.5GHz |
| LQP02TQ2N7C02□ | 2.7nH ±0.2nH | 500MHz | 10 | 500MHz | 370mA | 0.4Ω | 11.5GHz |
| LQP02TQ2N8B02□ | 2.8nH ±0.1nH | 500MHz | 10 | 500MHz | 360mA | 0.45Ω | 10.0GHz |
| LQP02TQ2N8C02□ | 2.8nH ±0.2nH | 500MHz | 10 | 500MHz | 360mA | 0.45Ω | 10.0GHz |
| LQP02TQ2N9B02□ | 2.9nH ±0.1nH | 500MHz | 10 | 500MHz | 360mA | 0.45Ω | 10.0GHz |
| LQP02TQ2N9C02□ | 2.9nH ±0.2nH | 500MHz | 10 | 500MHz | 360mA | 0.45Ω | 10.0GHz |
| LQP02TQ3N0B02□ | 3.0nH ±0.1nH | 500MHz | 10 | 500MHz | 360mA | 0.45Ω | 10.0GHz |
| LQP02TQ3N0C02□ | 3.0nH ±0.2nH | 500MHz | 10 | 500MHz | 360mA | 0.45Ω | 10.0GHz |
| LQP02TQ3N1B02□ | 3.1nH ±0.1nH | 500MHz | 10 | 500MHz | 290mA | 0.9Ω | 10.0GHz |
| LQP02TQ3N1C02□ | 3.1nH ±0.2nH | 500MHz | 10 | 500MHz | 290mA | 0.9Ω | 10.0GHz |
| LQP02TQ3N2B02□ | 3.2nH ±0.1nH | 500MHz | 10 | 500MHz | 290mA | 0.9Ω | 10.0GHz |
| LQP02TQ3N2C02□ | 3.2nH ±0.2nH | 500MHz | 10 | 500MHz | 290mA | 0.9Ω | 10.0GHz |
| LQP02TQ3N3B02□ | 3.3nH ±0.1nH | 500MHz | 10 | 500MHz | 290mA | 0.9Ω | 10.0GHz |
| LQP02TQ3N3C02□ | 3.3nH ±0.2nH | 500MHz | 10 | 500MHz | 290mA | 0.9Ω | 10.0GHz |
| LQP02TQ3N4B02□ | 3.4nH ±0.1nH | 500MHz | 10 | 500MHz | 280mA | 1.0Ω | 9.7GHz |
| LQP02TQ3N4C02□ | 3.4nH ±0.2nH | 500MHz | 10 | 500MHz | 280mA | 1.0Ω | 9.7GHz |
| LQP02TQ3N5B02□ | 3.5nH ±0.1nH | 500MHz | 10 | 500MHz | 280mA | 1.0Ω | 9.7GHz |
| LQP02TQ3N5C02□ | 3.5nH ±0.2nH | 500MHz | 10 | 500MHz | 280mA | 1.0Ω | 9.7GHz |
| LQP02TQ3N6B02□ | 3.6nH ±0.1nH | 500MHz | 10 | 500MHz | 280mA | 1.0Ω | 9.7GHz |
| LQP02TQ3N6C02□ | 3.6nH ±0.2nH | 500MHz | 10 | 500MHz | 280mA | 1.0Ω | 9.7GHz |
| LQP02TQ3N7B02□ | 3.7nH ±0.1nH | 500MHz | 10 | 500MHz | 270mA | 1.0Ω | 9.7GHz |
| LQP02TQ3N7C02□ | 3.7nH ±0.2nH | 500MHz | 10 | 500MHz | 270mA | 1.0Ω | 9.7GHz |
| LQP02TQ3N8B02□ | 3.8nH ±0.1nH | 500MHz | 10 | 500MHz | 270mA | 1.0Ω | 9.7GHz |
| LQP02TQ3N8C02□ | 3.8nH ±0.2nH | 500MHz | 10 | 500MHz | 270mA | 1.0Ω | 9.7GHz |
| LQP02TQ3N9B02□ | 3.9nH ±0.1nH | 500MHz | 10 | 500MHz | 270mA | 1.0Ω | 9.0GHz |
| LQP02TQ3N9C02□ | 3.9nH ±0.2nH | 500MHz | 10 | 500MHz | 270mA | 1.0Ω | 9.0GHz |
| LQP02TQ4N0B02□ | 4.0nH ±0.1nH | 500MHz | 10 | 500MHz | 270mA | 1.0Ω | 9.0GHz |
| LQP02TQ4N0C02□ | 4.0nH ±0.2nH | 500MHz | 10 | 500MHz | 270mA | 1.0Ω | 9.0GHz |
| LQP02TQ4N1B02□ | 4.1nH ±0.1nH | 500MHz | 10 | 500MHz | 270mA | 1.0Ω | 9.0GHz |

Operating temp. range: -55 to 125°C
 Only for reflow soldering
 *S.R.F.: Self Resonant Frequency

Continued on the following page. ↗

Continued from the preceding page. ↘

| Part Number (□: packaging code) | Inductance | Inductance Test Frequency | Q (min.) | Q Test Frequency | Rated Current | Max. of DC Resistance | S.R.F.* (min.) |
|------------------------------------|--------------|------------------------------|----------|------------------|---------------|-----------------------|----------------|
| LQP02TQ4N1C02□ | 4.1nH ±0.2nH | 500MHz | 10 | 500MHz | 270mA | 1.0Ω | 9.0GHz |
| LQP02TQ4N2B02□ | 4.2nH ±0.1nH | 500MHz | 10 | 500MHz | 270mA | 1.0Ω | 9.0GHz |
| LQP02TQ4N2C02□ | 4.2nH ±0.2nH | 500MHz | 10 | 500MHz | 270mA | 1.0Ω | 9.0GHz |
| LQP02TQ4N3H02□ | 4.3nH ±3% | 500MHz | 10 | 500MHz | 270mA | 1.0Ω | 9.0GHz |
| LQP02TQ4N3J02□ | 4.3nH ±5% | 500MHz | 10 | 500MHz | 270mA | 1.0Ω | 9.0GHz |
| LQP02TQ4N7H02□ | 4.7nH ±3% | 500MHz | 10 | 500MHz | 270mA | 1.0Ω | 8.5GHz |
| LQP02TQ4N7J02□ | 4.7nH ±5% | 500MHz | 10 | 500MHz | 270mA | 1.0Ω | 8.5GHz |
| LQP02TQ5N1H02□ | 5.1nH ±3% | 500MHz | 10 | 500MHz | 250mA | 1.2Ω | 7.8GHz |
| LQP02TQ5N1J02□ | 5.1nH ±5% | 500MHz | 10 | 500MHz | 250mA | 1.2Ω | 7.8GHz |
| LQP02TQ5N6H02□ | 5.6nH ±3% | 500MHz | 10 | 500MHz | 230mA | 1.3Ω | 7.8GHz |
| LQP02TQ5N6J02□ | 5.6nH ±5% | 500MHz | 10 | 500MHz | 230mA | 1.3Ω | 7.8GHz |
| LQP02TQ6N2H02□ | 6.2nH ±3% | 500MHz | 10 | 500MHz | 220mA | 1.3Ω | 7.2GHz |
| LQP02TQ6N2J02□ | 6.2nH ±5% | 500MHz | 10 | 500MHz | 220mA | 1.3Ω | 7.2GHz |
| LQP02TQ6N8H02□ | 6.8nH ±3% | 500MHz | 10 | 500MHz | 210mA | 1.4Ω | 6.6GHz |
| LQP02TQ6N8J02□ | 6.8nH ±5% | 500MHz | 10 | 500MHz | 210mA | 1.4Ω | 6.6GHz |
| LQP02TQ7N5H02□ | 7.5nH ±3% | 500MHz | 10 | 500MHz | 200mA | 1.5Ω | 6.6GHz |
| LQP02TQ7N5J02□ | 7.5nH ±5% | 500MHz | 10 | 500MHz | 200mA | 1.5Ω | 6.6GHz |
| LQP02TQ8N2H02□ | 8.2nH ±3% | 500MHz | 10 | 500MHz | 190mA | 1.6Ω | 6.6GHz |
| LQP02TQ8N2J02□ | 8.2nH ±5% | 500MHz | 10 | 500MHz | 190mA | 1.6Ω | 6.6GHz |
| LQP02TQ9N1H02□ | 9.1nH ±3% | 500MHz | 10 | 500MHz | 170mA | 1.7Ω | 5.9GHz |
| LQP02TQ9N1J02□ | 9.1nH ±5% | 500MHz | 10 | 500MHz | 170mA | 1.7Ω | 5.9GHz |
| LQP02TQ10NH02□ | 10nH ±3% | 500MHz | 10 | 500MHz | 170mA | 1.7Ω | 5.5GHz |
| LQP02TQ10NJ02□ | 10nH ±5% | 500MHz | 10 | 500MHz | 170mA | 1.7Ω | 5.5GHz |
| LQP02TQ11NH02□ | 11nH ±3% | 500MHz | 10 | 500MHz | 140mA | 1.9Ω | 3.5GHz |
| LQP02TQ11NJ02□ | 11nH ±5% | 500MHz | 10 | 500MHz | 140mA | 1.9Ω | 3.5GHz |
| LQP02TQ12NH02□ | 12nH ±3% | 500MHz | 10 | 500MHz | 140mA | 2.1Ω | 3.5GHz |
| LQP02TQ12NJ02□ | 12nH ±5% | 500MHz | 10 | 500MHz | 140mA | 2.1Ω | 3.5GHz |
| LQP02TQ13NH02□ | 13nH ±3% | 500MHz | 10 | 500MHz | 140mA | 2.1Ω | 3.0GHz |
| LQP02TQ13NJ02□ | 13nH ±5% | 500MHz | 10 | 500MHz | 140mA | 2.1Ω | 3.0GHz |
| LQP02TQ14NH02□ | 14nH ±3% | 500MHz | 10 | 500MHz | 140mA | 2.3Ω | 3.0GHz |
| LQP02TQ14NJ02□ | 14nH ±5% | 500MHz | 10 | 500MHz | 140mA | 2.3Ω | 3.0GHz |
| LQP02TQ15NH02□ | 15nH ±3% | 500MHz | 10 | 500MHz | 140mA | 2.3Ω | 3.0GHz |
| LQP02TQ15NJ02□ | 15nH ±5% | 500MHz | 10 | 500MHz | 140mA | 2.3Ω | 3.0GHz |
| LQP02TQ16NH02□ | 16nH ±3% | 500MHz | 10 | 500MHz | 140mA | 2.5Ω | 2.5GHz |
| LQP02TQ16NJ02□ | 16nH ±5% | 500MHz | 10 | 500MHz | 140mA | 2.5Ω | 2.5GHz |
| LQP02TQ17NH02□ | 17nH ±3% | 500MHz | 10 | 500MHz | 140mA | 2.5Ω | 2.5GHz |
| LQP02TQ17NJ02□ | 17nH ±5% | 500MHz | 10 | 500MHz | 140mA | 2.5Ω | 2.5GHz |
| LQP02TQ18NH02□ | 18nH ±3% | 500MHz | 8 | 500MHz | 140mA | 2.5Ω | 2.5GHz |
| LQP02TQ18NJ02□ | 18nH ±5% | 500MHz | 8 | 500MHz | 140mA | 2.5Ω | 2.5GHz |
| LQP02TQ19NH02□ | 19nH ±3% | 500MHz | 8 | 500MHz | 140mA | 2.9Ω | 2.7GHz |
| LQP02TQ19NJ02□ | 19nH ±5% | 500MHz | 8 | 500MHz | 140mA | 2.9Ω | 2.7GHz |
| LQP02TQ20NH02□ | 20nH ±3% | 500MHz | 8 | 500MHz | 140mA | 2.9Ω | 2.7GHz |
| LQP02TQ20NJ02□ | 20nH ±5% | 500MHz | 8 | 500MHz | 140mA | 2.9Ω | 2.7GHz |
| LQP02TQ21NH02□ | 21nH ±3% | 500MHz | 8 | 500MHz | 120mA | 3.2Ω | 2.3GHz |
| LQP02TQ21NJ02□ | 21nH ±5% | 500MHz | 8 | 500MHz | 120mA | 3.2Ω | 2.3GHz |
| LQP02TQ22NH02□ | 22nH ±3% | 500MHz | 8 | 500MHz | 120mA | 3.2Ω | 2.3GHz |
| LQP02TQ22NJ02□ | 22nH ±5% | 500MHz | 8 | 500MHz | 120mA | 3.2Ω | 2.3GHz |

Operating temp. range: -55 to 125°C

Only for reflow soldering

*S.R.F.: Self Resonant Frequency

Continued on the following page. ↗

Continued from the preceding page. ↘

Inductance-Frequency Characteristics (Typ.)



Q-Frequency Characteristics (Typ.)



LQP03HQ_02 Series 0201 (0603) inch (mm)



| Packaging Code | Packaging | Minimum Quantity |
|----------------|---------------------|------------------|
| D | ø180mm Paper Taping | 15000 |
| J | ø330mm Paper Taping | 50000 |
| B | Packing in Bulk | 500 |

| Part Number (□: packaging code) | Inductance | Inductance Test Frequency | Q (min.) | Q Test Frequency | Rated Current | Max. of DC Resistance | S.R.F.* (min.) |
|------------------------------------|---------------|---------------------------|----------|------------------|---------------|-----------------------|----------------|
| LQP03HQ0N6W02□ | 0.6nH ±0.05nH | 500MHz | 20 | 500MHz | 1100mA | 0.04Ω | 20000MHz |
| LQP03HQ0N6B02□ | 0.6nH ±0.1nH | 500MHz | 20 | 500MHz | 1100mA | 0.04Ω | 20000MHz |
| LQP03HQ0N6C02□ | 0.6nH ±0.2nH | 500MHz | 20 | 500MHz | 1100mA | 0.04Ω | 20000MHz |
| LQP03HQ0N7W02□ | 0.7nH ±0.05nH | 500MHz | 20 | 500MHz | 1100mA | 0.04Ω | 20000MHz |
| LQP03HQ0N7B02□ | 0.7nH ±0.1nH | 500MHz | 20 | 500MHz | 1100mA | 0.04Ω | 20000MHz |
| LQP03HQ0N7C02□ | 0.7nH ±0.2nH | 500MHz | 20 | 500MHz | 1100mA | 0.04Ω | 20000MHz |
| LQP03HQ0N8W02□ | 0.8nH ±0.05nH | 500MHz | 20 | 500MHz | 1100mA | 0.04Ω | 18000MHz |
| LQP03HQ0N8B02□ | 0.8nH ±0.1nH | 500MHz | 20 | 500MHz | 1100mA | 0.04Ω | 18000MHz |
| LQP03HQ0N8C02□ | 0.8nH ±0.2nH | 500MHz | 20 | 500MHz | 1100mA | 0.04Ω | 18000MHz |
| LQP03HQ0N9W02□ | 0.9nH ±0.05nH | 500MHz | 20 | 500MHz | 1100mA | 0.04Ω | 18000MHz |
| LQP03HQ0N9B02□ | 0.9nH ±0.1nH | 500MHz | 20 | 500MHz | 1100mA | 0.04Ω | 18000MHz |
| LQP03HQ0N9C02□ | 0.9nH ±0.2nH | 500MHz | 20 | 500MHz | 1100mA | 0.04Ω | 18000MHz |
| LQP03HQ1N0W02□ | 1.0nH ±0.05nH | 500MHz | 20 | 500MHz | 1100mA | 0.04Ω | 16000MHz |
| LQP03HQ1N0B02□ | 1.0nH ±0.1nH | 500MHz | 20 | 500MHz | 1100mA | 0.04Ω | 16000MHz |
| LQP03HQ1N0C02□ | 1.0nH ±0.2nH | 500MHz | 20 | 500MHz | 1100mA | 0.04Ω | 16000MHz |
| LQP03HQ1N1W02□ | 1.1nH ±0.05nH | 500MHz | 20 | 500MHz | 1100mA | 0.04Ω | 14000MHz |
| LQP03HQ1N1B02□ | 1.1nH ±0.1nH | 500MHz | 20 | 500MHz | 1100mA | 0.04Ω | 14000MHz |
| LQP03HQ1N1C02□ | 1.1nH ±0.2nH | 500MHz | 20 | 500MHz | 1100mA | 0.04Ω | 14000MHz |
| LQP03HQ1N2W02□ | 1.2nH ±0.05nH | 500MHz | 20 | 500MHz | 1100mA | 0.04Ω | 13000MHz |
| LQP03HQ1N2B02□ | 1.2nH ±0.1nH | 500MHz | 20 | 500MHz | 1100mA | 0.04Ω | 13000MHz |
| LQP03HQ1N2C02□ | 1.2nH ±0.2nH | 500MHz | 20 | 500MHz | 1100mA | 0.04Ω | 13000MHz |
| LQP03HQ1N3B02□ | 1.3nH ±0.1nH | 500MHz | 20 | 500MHz | 1100mA | 0.04Ω | 13000MHz |
| LQP03HQ1N3C02□ | 1.3nH ±0.2nH | 500MHz | 20 | 500MHz | 1100mA | 0.04Ω | 13000MHz |
| LQP03HQ1N4B02□ | 1.4nH ±0.1nH | 500MHz | 20 | 500MHz | 1100mA | 0.04Ω | 12000MHz |
| LQP03HQ1N4C02□ | 1.4nH ±0.2nH | 500MHz | 20 | 500MHz | 1100mA | 0.04Ω | 12000MHz |
| LQP03HQ1N5B02□ | 1.5nH ±0.1nH | 500MHz | 20 | 500MHz | 1000mA | 0.05Ω | 12000MHz |

Operating temp. range: -55 to 125°C

Only for reflow soldering

*S.R.F.: Self Resonant Frequency

Continued on the following page. ↗

Continued from the preceding page. ↘

| Part Number (□: packaging code) | Inductance | Inductance Test Frequency | Q (min.) | Q Test Frequency | Rated Current | Max. of DC Resistance | S.R.F.* (min.) |
|------------------------------------|--------------|------------------------------|----------|------------------|---------------|-----------------------|----------------|
| LQP03HQ1N5C02□ | 1.5nH ±0.2nH | 500MHz | 20 | 500MHz | 1000mA | 0.05Ω | 12000MHz |
| LQP03HQ1N6B02□ | 1.6nH ±0.1nH | 500MHz | 20 | 500MHz | 1000mA | 0.05Ω | 10000MHz |
| LQP03HQ1N6C02□ | 1.6nH ±0.2nH | 500MHz | 20 | 500MHz | 1000mA | 0.05Ω | 10000MHz |
| LQP03HQ1N7B02□ | 1.7nH ±0.1nH | 500MHz | 20 | 500MHz | 800mA | 0.07Ω | 10000MHz |
| LQP03HQ1N7C02□ | 1.7nH ±0.2nH | 500MHz | 20 | 500MHz | 800mA | 0.07Ω | 10000MHz |
| LQP03HQ1N8B02□ | 1.8nH ±0.1nH | 500MHz | 20 | 500MHz | 800mA | 0.08Ω | 10000MHz |
| LQP03HQ1N8C02□ | 1.8nH ±0.2nH | 500MHz | 20 | 500MHz | 800mA | 0.08Ω | 10000MHz |
| LQP03HQ1N9B02□ | 1.9nH ±0.1nH | 500MHz | 20 | 500MHz | 600mA | 0.12Ω | 10000MHz |
| LQP03HQ1N9C02□ | 1.9nH ±0.2nH | 500MHz | 20 | 500MHz | 600mA | 0.12Ω | 10000MHz |
| LQP03HQ2N0B02□ | 2.0nH ±0.1nH | 500MHz | 20 | 500MHz | 600mA | 0.12Ω | 9000MHz |
| LQP03HQ2N0C02□ | 2.0nH ±0.2nH | 500MHz | 20 | 500MHz | 600mA | 0.12Ω | 9000MHz |
| LQP03HQ2N1B02□ | 2.1nH ±0.1nH | 500MHz | 20 | 500MHz | 600mA | 0.12Ω | 9000MHz |
| LQP03HQ2N1C02□ | 2.1nH ±0.2nH | 500MHz | 20 | 500MHz | 600mA | 0.12Ω | 9000MHz |
| LQP03HQ2N2B02□ | 2.2nH ±0.1nH | 500MHz | 20 | 500MHz | 600mA | 0.12Ω | 9000MHz |
| LQP03HQ2N2C02□ | 2.2nH ±0.2nH | 500MHz | 20 | 500MHz | 600mA | 0.12Ω | 9000MHz |
| LQP03HQ2N3B02□ | 2.3nH ±0.1nH | 500MHz | 20 | 500MHz | 600mA | 0.12Ω | 9000MHz |
| LQP03HQ2N3C02□ | 2.3nH ±0.2nH | 500MHz | 20 | 500MHz | 600mA | 0.12Ω | 9000MHz |
| LQP03HQ2N4B02□ | 2.4nH ±0.1nH | 500MHz | 20 | 500MHz | 600mA | 0.12Ω | 9000MHz |
| LQP03HQ2N4C02□ | 2.4nH ±0.2nH | 500MHz | 20 | 500MHz | 600mA | 0.12Ω | 9000MHz |
| LQP03HQ2N5B02□ | 2.5nH ±0.1nH | 500MHz | 20 | 500MHz | 600mA | 0.12Ω | 9000MHz |
| LQP03HQ2N5C02□ | 2.5nH ±0.2nH | 500MHz | 20 | 500MHz | 600mA | 0.12Ω | 9000MHz |
| LQP03HQ2N6B02□ | 2.6nH ±0.1nH | 500MHz | 20 | 500MHz | 600mA | 0.12Ω | 9000MHz |
| LQP03HQ2N6C02□ | 2.6nH ±0.2nH | 500MHz | 20 | 500MHz | 600mA | 0.12Ω | 9000MHz |
| LQP03HQ2N7B02□ | 2.7nH ±0.1nH | 500MHz | 20 | 500MHz | 600mA | 0.12Ω | 9000MHz |
| LQP03HQ2N7C02□ | 2.7nH ±0.2nH | 500MHz | 20 | 500MHz | 600mA | 0.12Ω | 9000MHz |
| LQP03HQ2N8B02□ | 2.8nH ±0.1nH | 500MHz | 20 | 500MHz | 600mA | 0.12Ω | 8000MHz |
| LQP03HQ2N8C02□ | 2.8nH ±0.2nH | 500MHz | 20 | 500MHz | 600mA | 0.12Ω | 8000MHz |
| LQP03HQ2N9B02□ | 2.9nH ±0.1nH | 500MHz | 20 | 500MHz | 600mA | 0.12Ω | 8000MHz |
| LQP03HQ2N9C02□ | 2.9nH ±0.2nH | 500MHz | 20 | 500MHz | 600mA | 0.12Ω | 8000MHz |
| LQP03HQ3N0B02□ | 3.0nH ±0.1nH | 500MHz | 20 | 500MHz | 600mA | 0.12Ω | 8000MHz |
| LQP03HQ3N0C02□ | 3.0nH ±0.2nH | 500MHz | 20 | 500MHz | 600mA | 0.12Ω | 8000MHz |
| LQP03HQ3N1B02□ | 3.1nH ±0.1nH | 500MHz | 20 | 500MHz | 500mA | 0.17Ω | 7500MHz |
| LQP03HQ3N1C02□ | 3.1nH ±0.2nH | 500MHz | 20 | 500MHz | 500mA | 0.17Ω | 7500MHz |
| LQP03HQ3N2B02□ | 3.2nH ±0.1nH | 500MHz | 20 | 500MHz | 500mA | 0.17Ω | 7000MHz |
| LQP03HQ3N2C02□ | 3.2nH ±0.2nH | 500MHz | 20 | 500MHz | 500mA | 0.17Ω | 7000MHz |
| LQP03HQ3N3B02□ | 3.3nH ±0.1nH | 500MHz | 20 | 500MHz | 500mA | 0.17Ω | 7000MHz |
| LQP03HQ3N3C02□ | 3.3nH ±0.2nH | 500MHz | 20 | 500MHz | 500mA | 0.17Ω | 7000MHz |
| LQP03HQ3N4B02□ | 3.4nH ±0.1nH | 500MHz | 20 | 500MHz | 500mA | 0.17Ω | 7000MHz |
| LQP03HQ3N4C02□ | 3.4nH ±0.2nH | 500MHz | 20 | 500MHz | 500mA | 0.17Ω | 7000MHz |
| LQP03HQ3N5B02□ | 3.5nH ±0.1nH | 500MHz | 20 | 500MHz | 500mA | 0.17Ω | 7000MHz |
| LQP03HQ3N5C02□ | 3.5nH ±0.2nH | 500MHz | 20 | 500MHz | 500mA | 0.17Ω | 7000MHz |
| LQP03HQ3N6B02□ | 3.6nH ±0.1nH | 500MHz | 20 | 500MHz | 500mA | 0.17Ω | 7000MHz |
| LQP03HQ3N6C02□ | 3.6nH ±0.2nH | 500MHz | 20 | 500MHz | 500mA | 0.17Ω | 7000MHz |
| LQP03HQ3N7B02□ | 3.7nH ±0.1nH | 500MHz | 20 | 500MHz | 500mA | 0.17Ω | 7000MHz |
| LQP03HQ3N7C02□ | 3.7nH ±0.2nH | 500MHz | 20 | 500MHz | 500mA | 0.17Ω | 7000MHz |
| LQP03HQ3N8B02□ | 3.8nH ±0.1nH | 500MHz | 20 | 500MHz | 500mA | 0.17Ω | 7000MHz |
| LQP03HQ3N8C02□ | 3.8nH ±0.2nH | 500MHz | 20 | 500MHz | 500mA | 0.17Ω | 7000MHz |
| LQP03HQ3N9B02□ | 3.9nH ±0.1nH | 500MHz | 20 | 500MHz | 500mA | 0.17Ω | 7000MHz |
| LQP03HQ3N9C02□ | 3.9nH ±0.2nH | 500MHz | 20 | 500MHz | 500mA | 0.17Ω | 7000MHz |
| LQP03HQ4N0B02□ | 4.0nH ±0.1nH | 500MHz | 20 | 500MHz | 500mA | 0.17Ω | 7000MHz |
| LQP03HQ4N0C02□ | 4.0nH ±0.2nH | 500MHz | 20 | 500MHz | 500mA | 0.17Ω | 7000MHz |
| LQP03HQ4N1B02□ | 4.1nH ±0.1nH | 500MHz | 20 | 500MHz | 500mA | 0.17Ω | 7000MHz |
| LQP03HQ4N1C02□ | 4.1nH ±0.2nH | 500MHz | 20 | 500MHz | 500mA | 0.17Ω | 7000MHz |

Operating temp. range: -55 to 125°C
 Only for reflow soldering
 *S.R.F.: Self Resonant Frequency

Continued on the following page. ↗

Continued from the preceding page. ↘

| Part Number (□: packaging code) | Inductance | Inductance Test Frequency | Q (min.) | Q Test Frequency | Rated Current | Max. of DC Resistance | S.R.F.* (min.) |
|------------------------------------|--------------|------------------------------|----------|------------------|---------------|-----------------------|----------------|
| LQP03HQ4N2B02□ | 4.2nH ±0.1nH | 500MHz | 20 | 500MHz | 500mA | 0.17Ω | 7000MHz |
| LQP03HQ4N2C02□ | 4.2nH ±0.2nH | 500MHz | 20 | 500MHz | 500mA | 0.17Ω | 7000MHz |
| LQP03HQ4N3H02□ | 4.3nH ±3% | 500MHz | 20 | 500MHz | 500mA | 0.17Ω | 7000MHz |
| LQP03HQ4N3J02□ | 4.3nH ±5% | 500MHz | 20 | 500MHz | 500mA | 0.17Ω | 7000MHz |
| LQP03HQ4N7H02□ | 4.7nH ±3% | 500MHz | 20 | 500MHz | 400mA | 0.25Ω | 7000MHz |
| LQP03HQ4N7J02□ | 4.7nH ±5% | 500MHz | 20 | 500MHz | 400mA | 0.25Ω | 7000MHz |
| LQP03HQ5N1H02□ | 5.1nH ±3% | 500MHz | 20 | 500MHz | 400mA | 0.25Ω | 5500MHz |
| LQP03HQ5N1J02□ | 5.1nH ±5% | 500MHz | 20 | 500MHz | 400mA | 0.25Ω | 5500MHz |
| LQP03HQ5N6H02□ | 5.6nH ±3% | 500MHz | 20 | 500MHz | 400mA | 0.25Ω | 5500MHz |
| LQP03HQ5N6J02□ | 5.6nH ±5% | 500MHz | 20 | 500MHz | 400mA | 0.25Ω | 5500MHz |
| LQP03HQ6N2H02□ | 6.2nH ±3% | 500MHz | 20 | 500MHz | 400mA | 0.25Ω | 5500MHz |
| LQP03HQ6N2J02□ | 6.2nH ±5% | 500MHz | 20 | 500MHz | 400mA | 0.25Ω | 5500MHz |
| LQP03HQ6N8H02□ | 6.8nH ±3% | 500MHz | 20 | 500MHz | 400mA | 0.3Ω | 5500MHz |
| LQP03HQ6N8J02□ | 6.8nH ±5% | 500MHz | 20 | 500MHz | 400mA | 0.3Ω | 5500MHz |
| LQP03HQ7N5H02□ | 7.5nH ±3% | 500MHz | 20 | 500MHz | 400mA | 0.3Ω | 4500MHz |
| LQP03HQ7N5J02□ | 7.5nH ±5% | 500MHz | 20 | 500MHz | 400mA | 0.3Ω | 4500MHz |
| LQP03HQ8N2H02□ | 8.2nH ±3% | 500MHz | 20 | 500MHz | 300mA | 0.4Ω | 4500MHz |
| LQP03HQ8N2J02□ | 8.2nH ±5% | 500MHz | 20 | 500MHz | 300mA | 0.4Ω | 4500MHz |
| LQP03HQ9N1H02□ | 9.1nH ±3% | 500MHz | 20 | 500MHz | 300mA | 0.4Ω | 4500MHz |
| LQP03HQ9N1J02□ | 9.1nH ±5% | 500MHz | 20 | 500MHz | 300mA | 0.4Ω | 4500MHz |
| LQP03HQ10NH02□ | 10nH ±3% | 500MHz | 20 | 500MHz | 300mA | 0.4Ω | 4500MHz |
| LQP03HQ10NJ02□ | 10nH ±5% | 500MHz | 20 | 500MHz | 300mA | 0.4Ω | 4500MHz |
| LQP03HQ11NH02□ | 11nH ±3% | 500MHz | 20 | 500MHz | 300mA | 0.5Ω | 4000MHz |
| LQP03HQ11NJ02□ | 11nH ±5% | 500MHz | 20 | 500MHz | 300mA | 0.5Ω | 4000MHz |
| LQP03HQ12NH02□ | 12nH ±3% | 500MHz | 20 | 500MHz | 300mA | 0.5Ω | 4000MHz |
| LQP03HQ12NJ02□ | 12nH ±5% | 500MHz | 20 | 500MHz | 300mA | 0.5Ω | 4000MHz |
| LQP03HQ13NH02□ | 13nH ±3% | 500MHz | 20 | 500MHz | 300mA | 0.5Ω | 4000MHz |
| LQP03HQ13NJ02□ | 13nH ±5% | 500MHz | 20 | 500MHz | 300mA | 0.5Ω | 4000MHz |
| LQP03HQ15NH02□ | 15nH ±3% | 500MHz | 20 | 500MHz | 300mA | 0.7Ω | 3500MHz |
| LQP03HQ15NJ02□ | 15nH ±5% | 500MHz | 20 | 500MHz | 300mA | 0.7Ω | 3500MHz |
| LQP03HQ16NH02□ | 16nH ±3% | 500MHz | 20 | 500MHz | 250mA | 0.8Ω | 3500MHz |
| LQP03HQ16NJ02□ | 16nH ±5% | 500MHz | 20 | 500MHz | 250mA | 0.8Ω | 3500MHz |
| LQP03HQ18NH02□ | 18nH ±3% | 500MHz | 20 | 500MHz | 250mA | 0.8Ω | 3500MHz |
| LQP03HQ18NJ02□ | 18nH ±5% | 500MHz | 20 | 500MHz | 250mA | 0.8Ω | 3500MHz |
| LQP03HQ20NH02□ | 20nH ±3% | 500MHz | 20 | 500MHz | 250mA | 0.8Ω | 3000MHz |
| LQP03HQ20NJ02□ | 20nH ±5% | 500MHz | 20 | 500MHz | 250mA | 0.8Ω | 3000MHz |
| LQP03HQ22NH02□ | 22nH ±3% | 500MHz | 20 | 500MHz | 250mA | 0.82Ω | 3000MHz |
| LQP03HQ22NJ02□ | 22nH ±5% | 500MHz | 20 | 500MHz | 250mA | 0.82Ω | 3000MHz |
| LQP03HQ24NH02□ | 24nH ±3% | 500MHz | 15 | 500MHz | 170mA | 1.6Ω | 2000MHz |
| LQP03HQ24NJ02□ | 24nH ±5% | 500MHz | 15 | 500MHz | 170mA | 1.6Ω | 2000MHz |
| LQP03HQ27NH02□ | 27nH ±3% | 500MHz | 15 | 500MHz | 170mA | 1.6Ω | 2000MHz |
| LQP03HQ27NJ02□ | 27nH ±5% | 500MHz | 15 | 500MHz | 170mA | 1.6Ω | 2000MHz |
| LQP03HQ30NH02□ | 30nH ±3% | 500MHz | 12 | 500MHz | 150mA | 2.0Ω | 1700MHz |
| LQP03HQ30NJ02□ | 30nH ±5% | 500MHz | 12 | 500MHz | 150mA | 2.0Ω | 1700MHz |
| LQP03HQ33NH02□ | 33nH ±3% | 300MHz | 12 | 300MHz | 150mA | 2.0Ω | 1700MHz |
| LQP03HQ33NJ02□ | 33nH ±5% | 300MHz | 12 | 300MHz | 150mA | 2.0Ω | 1700MHz |
| LQP03HQ36NH02□ | 36nH ±3% | 300MHz | 12 | 300MHz | 150mA | 2.0Ω | 1500MHz |
| LQP03HQ36NJ02□ | 36nH ±5% | 300MHz | 12 | 300MHz | 150mA | 2.0Ω | 1500MHz |
| LQP03HQ39NH02□ | 39nH ±3% | 300MHz | 12 | 300MHz | 150mA | 2.0Ω | 1500MHz |
| LQP03HQ39NJ02□ | 39nH ±5% | 300MHz | 12 | 300MHz | 150mA | 2.0Ω | 1500MHz |
| LQP03HQ43NH02□ | 43nH ±3% | 300MHz | 12 | 300MHz | 130mA | 2.5Ω | 1300MHz |
| LQP03HQ43NJ02□ | 43nH ±5% | 300MHz | 12 | 300MHz | 130mA | 2.5Ω | 1300MHz |
| LQP03HQ47NH02□ | 47nH ±3% | 300MHz | 12 | 300MHz | 130mA | 2.5Ω | 1300MHz |

Operating temp. range: -55 to 125°C
 Only for reflow soldering
 *S.R.F.: Self Resonant Frequency

Continued on the following page. ↗

Continued from the preceding page. ↘

| Part Number (□: packaging code) | Inductance | Inductance Test Frequency | Q (min.) | Q Test Frequency | Rated Current | Max. of DC Resistance | S.R.F.* (min.) |
|------------------------------------|------------|------------------------------|----------|------------------|---------------|-----------------------|----------------|
| LQP03HQ47NJ02□ | 47nH ±5% | 300MHz | 12 | 300MHz | 130mA | 2.5Ω | 1300MHz |
| LQP03HQ51NH02□ | 51nH ±3% | 300MHz | 12 | 300MHz | 130mA | 2.5Ω | 1200MHz |
| LQP03HQ51NJ02□ | 51nH ±5% | 300MHz | 12 | 300MHz | 130mA | 2.5Ω | 1200MHz |
| LQP03HQ56NH02□ | 56nH ±3% | 300MHz | 12 | 300MHz | 130mA | 2.5Ω | 1200MHz |
| LQP03HQ56NJ02□ | 56nH ±5% | 300MHz | 12 | 300MHz | 130mA | 2.5Ω | 1200MHz |
| LQP03HQ62NH02□ | 62nH ±3% | 300MHz | 12 | 300MHz | 100mA | 5.0Ω | 1100MHz |
| LQP03HQ62NJ02□ | 62nH ±5% | 300MHz | 12 | 300MHz | 100mA | 5.0Ω | 1100MHz |
| LQP03HQ68NH02□ | 68nH ±3% | 300MHz | 12 | 300MHz | 100mA | 5.0Ω | 1100MHz |
| LQP03HQ68NJ02□ | 68nH ±5% | 300MHz | 12 | 300MHz | 100mA | 5.0Ω | 1100MHz |
| LQP03HQ75NH02□ | 75nH ±3% | 300MHz | 10 | 300MHz | 100mA | 5.0Ω | 1100MHz |
| LQP03HQ75NJ02□ | 75nH ±5% | 300MHz | 10 | 300MHz | 100mA | 5.0Ω | 1100MHz |
| LQP03HQ82NH02□ | 82nH ±3% | 300MHz | 10 | 300MHz | 100mA | 5.0Ω | 1000MHz |
| LQP03HQ82NJ02□ | 82nH ±5% | 300MHz | 10 | 300MHz | 100mA | 5.0Ω | 1000MHz |
| LQP03HQ91NH02□ | 91nH ±3% | 300MHz | 10 | 300MHz | 80mA | 7.0Ω | 1000MHz |
| LQP03HQ91NJ02□ | 91nH ±5% | 300MHz | 10 | 300MHz | 80mA | 7.0Ω | 1000MHz |
| LQP03HQR10H02□ | 100nH ±3% | 300MHz | 10 | 300MHz | 80mA | 7.0Ω | 900MHz |
| LQP03HQR10J02□ | 100nH ±5% | 300MHz | 10 | 300MHz | 80mA | 7.0Ω | 900MHz |
| LQP03HQR11H02□ | 110nH ±3% | 300MHz | 10 | 300MHz | 80mA | 8.0Ω | 900MHz |
| LQP03HQR11J02□ | 110nH ±5% | 300MHz | 10 | 300MHz | 80mA | 8.0Ω | 900MHz |
| LQP03HQR12H02□ | 120nH ±3% | 300MHz | 10 | 300MHz | 80mA | 8.0Ω | 800MHz |
| LQP03HQR12J02□ | 120nH ±5% | 300MHz | 10 | 300MHz | 80mA | 8.0Ω | 800MHz |
| LQP03HQR13H02□ | 130nH ±3% | 100MHz | 7 | 100MHz | 80mA | 8.0Ω | 700MHz |
| LQP03HQR13J02□ | 130nH ±5% | 100MHz | 7 | 100MHz | 80mA | 8.0Ω | 700MHz |
| LQP03HQR15H02□ | 150nH ±3% | 100MHz | 7 | 100MHz | 80mA | 8.0Ω | 700MHz |
| LQP03HQR15J02□ | 150nH ±5% | 100MHz | 7 | 100MHz | 80mA | 8.0Ω | 700MHz |

Operating temp. range: -55 to 125°C
 Only for reflow soldering
 *S.R.F.: Self Resonant Frequency

Inductance-Frequency Characteristics (Typ.)



Q-Frequency Characteristics (Typ.)



Inductors for Power Lines

Inductors for General Circuits

RF Inductors
 LQP03HQ_02

LQP03PN_02 Series 0201 (0603) inch (mm)



| Packaging Code | Packaging | Minimum Quantity |
|----------------|---------------------|------------------|
| D | ø180mm Paper Taping | 15000 |
| J | ø330mm Paper Taping | 50000 |
| B | Packing in Bulk | 500 |

| Part Number (□: packaging code) | Inductance | Inductance Test Frequency | Q (min.) | Q Test Frequency | Rated Current | Max. of DC Resistance | S.R.F.* (min.) |
|------------------------------------|--------------|---------------------------|----------|------------------|---|-----------------------|----------------|
| LQP03PN2N2C02□ | 2.2nH ±0.2nH | 500MHz | 10 | 500MHz | 1400mA(Ambient temp.85°C) 1000mA(Ambient temp.125°C) | 0.055Ω | 9000MHz |
| LQP03PN2N7C02□ | 2.7nH ±0.2nH | 500MHz | 10 | 500MHz | 1300mA(Ambient temp.85°C) 900mA(Ambient temp.125°C) | 0.065Ω | 6600MHz |
| LQP03PN3N3C02□ | 3.3nH ±0.2nH | 500MHz | 10 | 500MHz | 1200mA(Ambient temp.85°C) 800mA(Ambient temp.125°C) | 0.080Ω | 5500MHz |
| LQP03PN3N9C02□ | 3.9nH ±0.2nH | 500MHz | 10 | 500MHz | 1000mA(Ambient temp.85°C) 700mA(Ambient temp.125°C) | 0.100Ω | 4900MHz |
| LQP03PN4N7J02□ | 4.7nH ±5% | 500MHz | 10 | 500MHz | 900mA(Ambient temp.85°C) 600mA(Ambient temp.125°C) | 0.140Ω | 4400MHz |

Operating temp. range: -55 to 125°C

Only for reflow soldering

*S.R.F.: Self Resonant Frequency

In operating temperatures exceeding +85°C, derating of current is necessary for the LQP03PN_02 series. Please apply the derating curve shown in the chart according to the operating temperature. Please consider "Notice (Rating)."

Inductance-Frequency Characteristics (Typ.)



Q-Frequency Characteristics (Typ.)



Notice (Rating)

In operating temperatures exceeding +85°C, derating of current is necessary for the LQP03PN_02 series. Please apply the derating curve shown in the chart according to the operating temperature.



LQP03TG_02 Series 0201 (0603) inch (mm)



| Packaging Code | Packaging | Minimum Quantity |
|----------------|---------------------|------------------|
| D | ø180mm Paper Taping | 15000 |
| J | ø330mm Paper Taping | 50000 |
| B | Packing in Bulk | 500 |

Continued on the following page. ↗

Continued from the preceding page. ↘

| Part Number (□: packaging code) | Inductance | Inductance Test Frequency | Q (min.) | Q Test Frequency | Rated Current | Max. of DC Resistance | S.R.F.* (min.) |
|------------------------------------|--------------|------------------------------|----------|------------------|---------------|-----------------------|----------------|
| LQP03TG0N1B02□ | 0.1nH ±0.1nH | 500MHz | - | 500MHz | 850mA | 0.07Ω | 20000MHz |
| LQP03TG0N2B02□ | 0.2nH ±0.1nH | 500MHz | - | 500MHz | 850mA | 0.08Ω | 20000MHz |
| LQP03TG0N2C02□ | 0.2nH ±0.2nH | 500MHz | - | 500MHz | 850mA | 0.08Ω | 20000MHz |
| LQP03TG0N3B02□ | 0.3nH ±0.1nH | 500MHz | - | 500MHz | 850mA | 0.08Ω | 18000MHz |
| LQP03TG0N3C02□ | 0.3nH ±0.2nH | 500MHz | - | 500MHz | 850mA | 0.08Ω | 18000MHz |
| LQP03TG0N4B02□ | 0.4nH ±0.1nH | 500MHz | - | 500MHz | 850mA | 0.08Ω | 18000MHz |
| LQP03TG0N4C02□ | 0.4nH ±0.2nH | 500MHz | - | 500MHz | 850mA | 0.08Ω | 18000MHz |
| LQP03TG0N5B02□ | 0.5nH ±0.1nH | 500MHz | 11 | 500MHz | 850mA | 0.08Ω | 18000MHz |
| LQP03TG0N5C02□ | 0.5nH ±0.2nH | 500MHz | 11 | 500MHz | 850mA | 0.08Ω | 18000MHz |
| LQP03TG0N6B02□ | 0.6nH ±0.1nH | 500MHz | 11 | 500MHz | 850mA | 0.08Ω | 18000MHz |
| LQP03TG0N6C02□ | 0.6nH ±0.2nH | 500MHz | 11 | 500MHz | 850mA | 0.08Ω | 18000MHz |
| LQP03TG0N7B02□ | 0.7nH ±0.1nH | 500MHz | 12 | 500MHz | 750mA | 0.10Ω | 18000MHz |
| LQP03TG0N7C02□ | 0.7nH ±0.2nH | 500MHz | 12 | 500MHz | 750mA | 0.10Ω | 18000MHz |
| LQP03TG0N8B02□ | 0.8nH ±0.1nH | 500MHz | 12 | 500MHz | 750mA | 0.10Ω | 18000MHz |
| LQP03TG0N8C02□ | 0.8nH ±0.2nH | 500MHz | 12 | 500MHz | 750mA | 0.10Ω | 18000MHz |
| LQP03TG0N9B02□ | 0.9nH ±0.1nH | 500MHz | 12 | 500MHz | 700mA | 0.12Ω | 18000MHz |
| LQP03TG0N9C02□ | 0.9nH ±0.2nH | 500MHz | 12 | 500MHz | 700mA | 0.12Ω | 18000MHz |
| LQP03TG1N0B02□ | 1.0nH ±0.1nH | 500MHz | 12 | 500MHz | 600mA | 0.15Ω | 17000MHz |
| LQP03TG1N0C02□ | 1.0nH ±0.2nH | 500MHz | 12 | 500MHz | 600mA | 0.15Ω | 17000MHz |
| LQP03TG1N1B02□ | 1.1nH ±0.1nH | 500MHz | 12 | 500MHz | 600mA | 0.15Ω | 17000MHz |
| LQP03TG1N1C02□ | 1.1nH ±0.2nH | 500MHz | 12 | 500MHz | 600mA | 0.15Ω | 17000MHz |
| LQP03TG1N2B02□ | 1.2nH ±0.1nH | 500MHz | 13 | 500MHz | 600mA | 0.15Ω | 15000MHz |
| LQP03TG1N2C02□ | 1.2nH ±0.2nH | 500MHz | 13 | 500MHz | 600mA | 0.15Ω | 15000MHz |
| LQP03TG1N3B02□ | 1.3nH ±0.1nH | 500MHz | 13 | 500MHz | 600mA | 0.15Ω | 15000MHz |
| LQP03TG1N3C02□ | 1.3nH ±0.2nH | 500MHz | 13 | 500MHz | 600mA | 0.15Ω | 15000MHz |
| LQP03TG1N4B02□ | 1.4nH ±0.1nH | 500MHz | 13 | 500MHz | 600mA | 0.15Ω | 14000MHz |
| LQP03TG1N4C02□ | 1.4nH ±0.2nH | 500MHz | 13 | 500MHz | 600mA | 0.15Ω | 14000MHz |
| LQP03TG1N5B02□ | 1.5nH ±0.1nH | 500MHz | 13 | 500MHz | 600mA | 0.15Ω | 13500MHz |
| LQP03TG1N5C02□ | 1.5nH ±0.2nH | 500MHz | 13 | 500MHz | 600mA | 0.15Ω | 13500MHz |
| LQP03TG1N6B02□ | 1.6nH ±0.1nH | 500MHz | 13 | 500MHz | 600mA | 0.15Ω | 13000MHz |
| LQP03TG1N6C02□ | 1.6nH ±0.2nH | 500MHz | 13 | 500MHz | 600mA | 0.15Ω | 13000MHz |
| LQP03TG1N7B02□ | 1.7nH ±0.1nH | 500MHz | 13 | 500MHz | 500mA | 0.20Ω | 12500MHz |
| LQP03TG1N7C02□ | 1.7nH ±0.2nH | 500MHz | 13 | 500MHz | 500mA | 0.20Ω | 12500MHz |
| LQP03TG1N8B02□ | 1.8nH ±0.1nH | 500MHz | 13 | 500MHz | 500mA | 0.20Ω | 12500MHz |
| LQP03TG1N8C02□ | 1.8nH ±0.2nH | 500MHz | 13 | 500MHz | 500mA | 0.20Ω | 12500MHz |
| LQP03TG1N9B02□ | 1.9nH ±0.1nH | 500MHz | 13 | 500MHz | 450mA | 0.25Ω | 12500MHz |
| LQP03TG1N9C02□ | 1.9nH ±0.2nH | 500MHz | 13 | 500MHz | 450mA | 0.25Ω | 12500MHz |
| LQP03TG2N0B02□ | 2.0nH ±0.1nH | 500MHz | 13 | 500MHz | 450mA | 0.25Ω | 12500MHz |
| LQP03TG2N0C02□ | 2.0nH ±0.2nH | 500MHz | 13 | 500MHz | 450mA | 0.25Ω | 12500MHz |
| LQP03TG2N1B02□ | 2.1nH ±0.1nH | 500MHz | 13 | 500MHz | 450mA | 0.25Ω | 12000MHz |
| LQP03TG2N1C02□ | 2.1nH ±0.2nH | 500MHz | 13 | 500MHz | 450mA | 0.25Ω | 12000MHz |
| LQP03TG2N2B02□ | 2.2nH ±0.1nH | 500MHz | 13 | 500MHz | 450mA | 0.25Ω | 12000MHz |
| LQP03TG2N2C02□ | 2.2nH ±0.2nH | 500MHz | 13 | 500MHz | 450mA | 0.25Ω | 12000MHz |
| LQP03TG2N3B02□ | 2.3nH ±0.1nH | 500MHz | 13 | 500MHz | 450mA | 0.25Ω | 11500MHz |
| LQP03TG2N3C02□ | 2.3nH ±0.2nH | 500MHz | 13 | 500MHz | 450mA | 0.25Ω | 11500MHz |
| LQP03TG2N4B02□ | 2.4nH ±0.1nH | 500MHz | 13 | 500MHz | 450mA | 0.25Ω | 11000MHz |
| LQP03TG2N4C02□ | 2.4nH ±0.2nH | 500MHz | 13 | 500MHz | 450mA | 0.25Ω | 11000MHz |
| LQP03TG2N5B02□ | 2.5nH ±0.1nH | 500MHz | 13 | 500MHz | 450mA | 0.25Ω | 11000MHz |
| LQP03TG2N5C02□ | 2.5nH ±0.2nH | 500MHz | 13 | 500MHz | 450mA | 0.25Ω | 11000MHz |
| LQP03TG2N6B02□ | 2.6nH ±0.1nH | 500MHz | 13 | 500MHz | 450mA | 0.25Ω | 11000MHz |
| LQP03TG2N6C02□ | 2.6nH ±0.2nH | 500MHz | 13 | 500MHz | 450mA | 0.25Ω | 11000MHz |
| LQP03TG2N7B02□ | 2.7nH ±0.1nH | 500MHz | 13 | 500MHz | 450mA | 0.25Ω | 11000MHz |
| LQP03TG2N7C02□ | 2.7nH ±0.2nH | 500MHz | 13 | 500MHz | 450mA | 0.25Ω | 11000MHz |

Operating temp. range: -55 to 125°C
 Only for reflow soldering
 *S.R.F.: Self Resonant Frequency

Continued on the following page. ↗

Inductors for Power Lines

Inductors for General Circuits

RF Inductors
 LQP03TG_02

Continued from the preceding page. ↘

| Part Number (□: packaging code) | Inductance | Inductance Test Frequency | Q (min.) | Q Test Frequency | Rated Current | Max. of DC Resistance | S.R.F.* (min.) |
|------------------------------------|--------------|------------------------------|----------|------------------|---------------|-----------------------|----------------|
| LQP03TG2N8B02□ | 2.8nH ±0.1nH | 500MHz | 13 | 500MHz | 450mA | 0.25Ω | 9500MHz |
| LQP03TG2N8C02□ | 2.8nH ±0.2nH | 500MHz | 13 | 500MHz | 450mA | 0.25Ω | 9500MHz |
| LQP03TG2N9B02□ | 2.9nH ±0.1nH | 500MHz | 13 | 500MHz | 450mA | 0.25Ω | 9500MHz |
| LQP03TG2N9C02□ | 2.9nH ±0.2nH | 500MHz | 13 | 500MHz | 450mA | 0.25Ω | 9500MHz |
| LQP03TG3N0B02□ | 3.0nH ±0.1nH | 500MHz | 13 | 500MHz | 450mA | 0.25Ω | 9500MHz |
| LQP03TG3N0C02□ | 3.0nH ±0.2nH | 500MHz | 13 | 500MHz | 450mA | 0.25Ω | 9500MHz |
| LQP03TG3N1B02□ | 3.1nH ±0.1nH | 500MHz | 13 | 500MHz | 400mA | 0.32Ω | 9500MHz |
| LQP03TG3N1C02□ | 3.1nH ±0.2nH | 500MHz | 13 | 500MHz | 400mA | 0.32Ω | 9500MHz |
| LQP03TG3N2B02□ | 3.2nH ±0.1nH | 500MHz | 13 | 500MHz | 400mA | 0.32Ω | 9500MHz |
| LQP03TG3N2C02□ | 3.2nH ±0.2nH | 500MHz | 13 | 500MHz | 400mA | 0.32Ω | 9500MHz |
| LQP03TG3N3B02□ | 3.3nH ±0.1nH | 500MHz | 13 | 500MHz | 400mA | 0.32Ω | 9500MHz |
| LQP03TG3N3C02□ | 3.3nH ±0.2nH | 500MHz | 13 | 500MHz | 400mA | 0.32Ω | 9500MHz |
| LQP03TG3N4B02□ | 3.4nH ±0.1nH | 500MHz | 13 | 500MHz | 350mA | 0.35Ω | 8000MHz |
| LQP03TG3N4C02□ | 3.4nH ±0.2nH | 500MHz | 13 | 500MHz | 350mA | 0.35Ω | 8000MHz |
| LQP03TG3N5B02□ | 3.5nH ±0.1nH | 500MHz | 13 | 500MHz | 350mA | 0.35Ω | 8000MHz |
| LQP03TG3N5C02□ | 3.5nH ±0.2nH | 500MHz | 13 | 500MHz | 350mA | 0.35Ω | 8000MHz |
| LQP03TG3N6B02□ | 3.6nH ±0.1nH | 500MHz | 13 | 500MHz | 350mA | 0.35Ω | 8000MHz |
| LQP03TG3N6C02□ | 3.6nH ±0.2nH | 500MHz | 13 | 500MHz | 350mA | 0.35Ω | 8000MHz |
| LQP03TG3N7B02□ | 3.7nH ±0.1nH | 500MHz | 13 | 500MHz | 350mA | 0.35Ω | 7000MHz |
| LQP03TG3N7C02□ | 3.7nH ±0.2nH | 500MHz | 13 | 500MHz | 350mA | 0.35Ω | 7000MHz |
| LQP03TG3N8B02□ | 3.8nH ±0.1nH | 500MHz | 13 | 500MHz | 350mA | 0.35Ω | 7000MHz |
| LQP03TG3N8C02□ | 3.8nH ±0.2nH | 500MHz | 13 | 500MHz | 350mA | 0.35Ω | 7000MHz |
| LQP03TG3N9B02□ | 3.9nH ±0.1nH | 500MHz | 13 | 500MHz | 350mA | 0.35Ω | 6500MHz |
| LQP03TG3N9C02□ | 3.9nH ±0.2nH | 500MHz | 13 | 500MHz | 350mA | 0.35Ω | 6500MHz |
| LQP03TG4N3H02□ | 4.3nH ±3% | 500MHz | 13 | 500MHz | 300mA | 0.58Ω | 6500MHz |
| LQP03TG4N3J02□ | 4.3nH ±5% | 500MHz | 13 | 500MHz | 300mA | 0.58Ω | 6500MHz |
| LQP03TG4N7H02□ | 4.7nH ±3% | 500MHz | 12 | 500MHz | 250mA | 0.72Ω | 6500MHz |
| LQP03TG4N7J02□ | 4.7nH ±5% | 500MHz | 12 | 500MHz | 250mA | 0.72Ω | 6500MHz |
| LQP03TG5N1H02□ | 5.1nH ±3% | 500MHz | 12 | 500MHz | 250mA | 0.72Ω | 6500MHz |
| LQP03TG5N1J02□ | 5.1nH ±5% | 500MHz | 12 | 500MHz | 250mA | 0.72Ω | 6500MHz |
| LQP03TG5N6H02□ | 5.6nH ±3% | 500MHz | 12 | 500MHz | 250mA | 0.88Ω | 6000MHz |
| LQP03TG5N6J02□ | 5.6nH ±5% | 500MHz | 12 | 500MHz | 250mA | 0.88Ω | 6000MHz |
| LQP03TG6N2H02□ | 6.2nH ±3% | 500MHz | 12 | 500MHz | 200mA | 1.15Ω | 6000MHz |
| LQP03TG6N2J02□ | 6.2nH ±5% | 500MHz | 12 | 500MHz | 200mA | 1.15Ω | 6000MHz |
| LQP03TG6N8H02□ | 6.8nH ±3% | 500MHz | 12 | 500MHz | 200mA | 1.15Ω | 5400MHz |
| LQP03TG6N8J02□ | 6.8nH ±5% | 500MHz | 12 | 500MHz | 200mA | 1.15Ω | 5400MHz |
| LQP03TG7N5H02□ | 7.5nH ±3% | 500MHz | 12 | 500MHz | 200mA | 1.22Ω | 4800MHz |
| LQP03TG7N5J02□ | 7.5nH ±5% | 500MHz | 12 | 500MHz | 200mA | 1.22Ω | 4800MHz |
| LQP03TG8N2H02□ | 8.2nH ±3% | 500MHz | 12 | 500MHz | 200mA | 1.40Ω | 4800MHz |
| LQP03TG8N2J02□ | 8.2nH ±5% | 500MHz | 12 | 500MHz | 200mA | 1.40Ω | 4800MHz |
| LQP03TG9N1H02□ | 9.1nH ±3% | 500MHz | 11 | 500MHz | 200mA | 1.40Ω | 4500MHz |
| LQP03TG9N1J02□ | 9.1nH ±5% | 500MHz | 11 | 500MHz | 200mA | 1.40Ω | 4500MHz |
| LQP03TG10NH02□ | 10nH ±3% | 500MHz | 11 | 500MHz | 190mA | 1.52Ω | 4500MHz |
| LQP03TG10NJ02□ | 10nH ±5% | 500MHz | 11 | 500MHz | 190mA | 1.52Ω | 4500MHz |
| LQP03TG11NH02□ | 11nH ±3% | 500MHz | 11 | 500MHz | 180mA | 1.65Ω | 4100MHz |
| LQP03TG11NJ02□ | 11nH ±5% | 500MHz | 11 | 500MHz | 180mA | 1.65Ω | 4100MHz |
| LQP03TG12NH02□ | 12nH ±3% | 500MHz | 11 | 500MHz | 180mA | 1.78Ω | 3700MHz |
| LQP03TG12NJ02□ | 12nH ±5% | 500MHz | 11 | 500MHz | 180mA | 1.78Ω | 3700MHz |
| LQP03TG13NH02□ | 13nH ±3% | 500MHz | 11 | 500MHz | 170mA | 1.82Ω | 3400MHz |
| LQP03TG13NJ02□ | 13nH ±5% | 500MHz | 11 | 500MHz | 170mA | 1.82Ω | 3400MHz |
| LQP03TG15NH02□ | 15nH ±3% | 500MHz | 11 | 500MHz | 170mA | 1.90Ω | 3100MHz |
| LQP03TG15NJ02□ | 15nH ±5% | 500MHz | 11 | 500MHz | 170mA | 1.90Ω | 3100MHz |
| LQP03TG16NH02□ | 16nH ±3% | 500MHz | 11 | 500MHz | 160mA | 2.03Ω | 2900MHz |

Operating temp. range: -55 to 125°C
 Only for reflow soldering
 *S.R.F.: Self Resonant Frequency

Continued on the following page. ↗

Continued from the preceding page. ↘

| Part Number (□: packaging code) | Inductance | Inductance Test Frequency | Q (min.) | Q Test Frequency | Rated Current | Max. of DC Resistance | S.R.F.* (min.) |
|------------------------------------|------------|---------------------------|----------|------------------|---------------|-----------------------|----------------|
| LQP03TG16NJ02□ | 16nH ±5% | 500MHz | 11 | 500MHz | 160mA | 2.03Ω | 2900MHz |
| LQP03TG18NH02□ | 18nH ±3% | 500MHz | 11 | 500MHz | 160mA | 2.28Ω | 2800MHz |
| LQP03TG18NJ02□ | 18nH ±5% | 500MHz | 11 | 500MHz | 160mA | 2.28Ω | 2800MHz |
| LQP03TG20NH02□ | 20nH ±3% | 500MHz | 9 | 500MHz | 140mA | 2.57Ω | 2600MHz |
| LQP03TG20NJ02□ | 20nH ±5% | 500MHz | 9 | 500MHz | 140mA | 2.57Ω | 2600MHz |
| LQP03TG22NH02□ | 22nH ±3% | 500MHz | 9 | 500MHz | 140mA | 2.85Ω | 2500MHz |
| LQP03TG22NJ02□ | 22nH ±5% | 500MHz | 9 | 500MHz | 140mA | 2.85Ω | 2500MHz |
| LQP03TG24NH02□ | 24nH ±3% | 500MHz | 7 | 500MHz | 120mA | 3.17Ω | 2000MHz |
| LQP03TG24NJ02□ | 24nH ±5% | 500MHz | 7 | 500MHz | 120mA | 3.17Ω | 2000MHz |
| LQP03TG27NH02□ | 27nH ±3% | 500MHz | 7 | 500MHz | 120mA | 3.65Ω | 1700MHz |
| LQP03TG27NJ02□ | 27nH ±5% | 500MHz | 7 | 500MHz | 120mA | 3.65Ω | 1700MHz |
| LQP03TG33NJ02□ | 33nH ±5% | 300MHz | 7 | 300MHz | 110mA | 4.25Ω | 1600MHz |
| LQP03TG39NJ02□ | 39nH ±5% | 300MHz | 7 | 300MHz | 110mA | 4.6Ω | 1500MHz |
| LQP03TG47NJ02□ | 47nH ±5% | 300MHz | 7 | 300MHz | 100mA | 5.2Ω | 1300MHz |
| LQP03TG56NJ02□ | 56nH ±5% | 300MHz | 7 | 300MHz | 100mA | 5.6Ω | 1200MHz |
| LQP03TG68NJ02□ | 68nH ±5% | 300MHz | 6 | 300MHz | 90mA | 6.25Ω | 1100MHz |
| LQP03TG82NJ02□ | 82nH ±5% | 300MHz | 6 | 300MHz | 90mA | 7.15Ω | 1000MHz |
| LQP03TGR10J02□ | 100nH ±5% | 300MHz | 6 | 300MHz | 80mA | 8.05Ω | 900MHz |
| LQP03TGR12J02□ | 120nH ±5% | 300MHz | 6 | 300MHz | 80mA | 8.75Ω | 800MHz |

Operating temp. range: -55 to 125°C

Only for reflow soldering

*S.R.F.: Self Resonant Frequency

Inductance-Frequency Characteristics (Typ.)

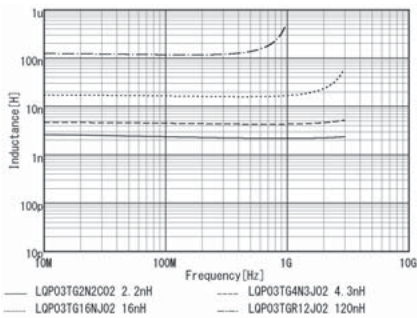

Q-Frequency Characteristics (Typ.)

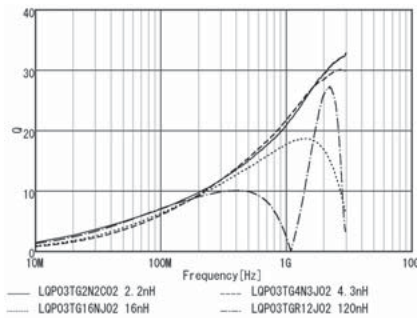

LQP03TN_02 Series 0201 (0603) inch (mm)

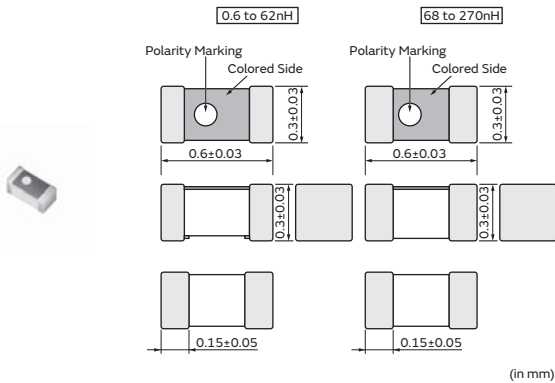

| Packaging Code | Packaging | Minimum Quantity |
|----------------|---------------------|------------------|
| D | ø180mm Paper Taping | 15000 |
| J | ø330mm Paper Taping | 50000 |
| B | Packing in Bulk | 500 |

Continued on the following page. ↗

Continued from the preceding page. ↘

| Part Number (□: packaging code) | Inductance | Inductance Test Frequency | Q (min.) | Q Test Frequency | Rated Current | Max. of DC Resistance | S.R.F.* (min.) |
|------------------------------------|--------------|------------------------------|----------|------------------|---------------|-----------------------|----------------|
| LQP03TN0N6B02□ | 0.6nH ±0.1nH | 500MHz | 14 | 500MHz | 850mA | 0.07Ω | 20000MHz |
| LQP03TN0N6C02□ | 0.6nH ±0.2nH | 500MHz | 14 | 500MHz | 850mA | 0.07Ω | 20000MHz |
| LQP03TN0N7B02□ | 0.7nH ±0.1nH | 500MHz | 14 | 500MHz | 800mA | 0.08Ω | 20000MHz |
| LQP03TN0N7C02□ | 0.7nH ±0.2nH | 500MHz | 14 | 500MHz | 800mA | 0.08Ω | 20000MHz |
| LQP03TN0N8B02□ | 0.8nH ±0.1nH | 500MHz | 14 | 500MHz | 800mA | 0.08Ω | 18000MHz |
| LQP03TN0N8C02□ | 0.8nH ±0.2nH | 500MHz | 14 | 500MHz | 800mA | 0.08Ω | 18000MHz |
| LQP03TN0N9B02□ | 0.9nH ±0.1nH | 500MHz | 14 | 500MHz | 750mA | 0.10Ω | 18000MHz |
| LQP03TN0N9C02□ | 0.9nH ±0.2nH | 500MHz | 14 | 500MHz | 750mA | 0.10Ω | 18000MHz |
| LQP03TN1N0B02□ | 1.0nH ±0.1nH | 500MHz | 14 | 500MHz | 750mA | 0.10Ω | 17000MHz |
| LQP03TN1N0C02□ | 1.0nH ±0.2nH | 500MHz | 14 | 500MHz | 750mA | 0.10Ω | 17000MHz |
| LQP03TN1N1B02□ | 1.1nH ±0.1nH | 500MHz | 14 | 500MHz | 750mA | 0.10Ω | 17000MHz |
| LQP03TN1N1C02□ | 1.1nH ±0.2nH | 500MHz | 14 | 500MHz | 750mA | 0.10Ω | 17000MHz |
| LQP03TN1N2B02□ | 1.2nH ±0.1nH | 500MHz | 14 | 500MHz | 750mA | 0.10Ω | 17000MHz |
| LQP03TN1N2C02□ | 1.2nH ±0.2nH | 500MHz | 14 | 500MHz | 750mA | 0.10Ω | 17000MHz |
| LQP03TN1N3B02□ | 1.3nH ±0.1nH | 500MHz | 14 | 500MHz | 600mA | 0.15Ω | 17000MHz |
| LQP03TN1N3C02□ | 1.3nH ±0.2nH | 500MHz | 14 | 500MHz | 600mA | 0.15Ω | 17000MHz |
| LQP03TN1N4B02□ | 1.4nH ±0.1nH | 500MHz | 14 | 500MHz | 600mA | 0.15Ω | 16000MHz |
| LQP03TN1N4C02□ | 1.4nH ±0.2nH | 500MHz | 14 | 500MHz | 600mA | 0.15Ω | 16000MHz |
| LQP03TN1N5B02□ | 1.5nH ±0.1nH | 500MHz | 14 | 500MHz | 600mA | 0.15Ω | 15000MHz |
| LQP03TN1N5C02□ | 1.5nH ±0.2nH | 500MHz | 14 | 500MHz | 600mA | 0.15Ω | 15000MHz |
| LQP03TN1N6B02□ | 1.6nH ±0.1nH | 500MHz | 14 | 500MHz | 600mA | 0.15Ω | 15000MHz |
| LQP03TN1N6C02□ | 1.6nH ±0.2nH | 500MHz | 14 | 500MHz | 600mA | 0.15Ω | 15000MHz |
| LQP03TN1N7B02□ | 1.7nH ±0.1nH | 500MHz | 14 | 500MHz | 600mA | 0.15Ω | 15000MHz |
| LQP03TN1N7C02□ | 1.7nH ±0.2nH | 500MHz | 14 | 500MHz | 600mA | 0.15Ω | 15000MHz |
| LQP03TN1N8B02□ | 1.8nH ±0.1nH | 500MHz | 14 | 500MHz | 600mA | 0.15Ω | 15000MHz |
| LQP03TN1N8C02□ | 1.8nH ±0.2nH | 500MHz | 14 | 500MHz | 600mA | 0.15Ω | 15000MHz |
| LQP03TN1N9B02□ | 1.9nH ±0.1nH | 500MHz | 14 | 500MHz | 600mA | 0.15Ω | 12500MHz |
| LQP03TN1N9C02□ | 1.9nH ±0.2nH | 500MHz | 14 | 500MHz | 600mA | 0.15Ω | 12500MHz |
| LQP03TN2N0B02□ | 2.0nH ±0.1nH | 500MHz | 14 | 500MHz | 600mA | 0.15Ω | 12500MHz |
| LQP03TN2N0C02□ | 2.0nH ±0.2nH | 500MHz | 14 | 500MHz | 600mA | 0.15Ω | 12500MHz |
| LQP03TN2N1B02□ | 2.1nH ±0.1nH | 500MHz | 14 | 500MHz | 600mA | 0.15Ω | 11000MHz |
| LQP03TN2N1C02□ | 2.1nH ±0.2nH | 500MHz | 14 | 500MHz | 600mA | 0.15Ω | 11000MHz |
| LQP03TN2N2B02□ | 2.2nH ±0.1nH | 500MHz | 14 | 500MHz | 600mA | 0.15Ω | 11000MHz |
| LQP03TN2N2C02□ | 2.2nH ±0.2nH | 500MHz | 14 | 500MHz | 600mA | 0.15Ω | 11000MHz |
| LQP03TN2N3B02□ | 2.3nH ±0.1nH | 500MHz | 14 | 500MHz | 500mA | 0.20Ω | 10000MHz |
| LQP03TN2N3C02□ | 2.3nH ±0.2nH | 500MHz | 14 | 500MHz | 500mA | 0.20Ω | 10000MHz |
| LQP03TN2N4B02□ | 2.4nH ±0.1nH | 500MHz | 14 | 500MHz | 500mA | 0.20Ω | 10000MHz |
| LQP03TN2N4C02□ | 2.4nH ±0.2nH | 500MHz | 14 | 500MHz | 500mA | 0.20Ω | 10000MHz |
| LQP03TN2N5B02□ | 2.5nH ±0.1nH | 500MHz | 14 | 500MHz | 500mA | 0.20Ω | 10000MHz |
| LQP03TN2N5C02□ | 2.5nH ±0.2nH | 500MHz | 14 | 500MHz | 500mA | 0.20Ω | 10000MHz |
| LQP03TN2N6B02□ | 2.6nH ±0.1nH | 500MHz | 14 | 500MHz | 500mA | 0.20Ω | 10000MHz |
| LQP03TN2N6C02□ | 2.6nH ±0.2nH | 500MHz | 14 | 500MHz | 500mA | 0.20Ω | 10000MHz |
| LQP03TN2N7B02□ | 2.7nH ±0.1nH | 500MHz | 14 | 500MHz | 500mA | 0.20Ω | 10000MHz |
| LQP03TN2N7C02□ | 2.7nH ±0.2nH | 500MHz | 14 | 500MHz | 500mA | 0.20Ω | 10000MHz |
| LQP03TN2N8B02□ | 2.8nH ±0.1nH | 500MHz | 14 | 500MHz | 500mA | 0.20Ω | 9500MHz |
| LQP03TN2N8C02□ | 2.8nH ±0.2nH | 500MHz | 14 | 500MHz | 500mA | 0.20Ω | 9500MHz |
| LQP03TN2N9B02□ | 2.9nH ±0.1nH | 500MHz | 14 | 500MHz | 500mA | 0.20Ω | 9500MHz |
| LQP03TN2N9C02□ | 2.9nH ±0.2nH | 500MHz | 14 | 500MHz | 500mA | 0.20Ω | 9500MHz |
| LQP03TN3N0B02□ | 3.0nH ±0.1nH | 500MHz | 14 | 500MHz | 450mA | 0.25Ω | 9500MHz |
| LQP03TN3N0C02□ | 3.0nH ±0.2nH | 500MHz | 14 | 500MHz | 450mA | 0.25Ω | 9500MHz |
| LQP03TN3N1B02□ | 3.1nH ±0.1nH | 500MHz | 14 | 500MHz | 450mA | 0.25Ω | 8000MHz |
| LQP03TN3N1C02□ | 3.1nH ±0.2nH | 500MHz | 14 | 500MHz | 450mA | 0.25Ω | 8000MHz |
| LQP03TN3N2B02□ | 3.2nH ±0.1nH | 500MHz | 14 | 500MHz | 450mA | 0.25Ω | 8000MHz |

Operating temp. range: -55 to 125°C
 Only for reflow soldering
 *S.R.F.: Self Resonant Frequency

Continued on the following page. ↗

Continued from the preceding page. ↘

| Part Number (□: packaging code) | Inductance | Inductance Test Frequency | Q (min.) | Q Test Frequency | Rated Current | Max. of DC Resistance | S.R.F.* (min.) |
|------------------------------------|--------------|------------------------------|----------|------------------|---------------|-----------------------|----------------|
| LQP03TN3N2C02□ | 3.2nH ±0.2nH | 500MHz | 14 | 500MHz | 450mA | 0.25Ω | 8000MHz |
| LQP03TN3N3B02□ | 3.3nH ±0.1nH | 500MHz | 14 | 500MHz | 450mA | 0.25Ω | 8000MHz |
| LQP03TN3N3C02□ | 3.3nH ±0.2nH | 500MHz | 14 | 500MHz | 450mA | 0.25Ω | 8000MHz |
| LQP03TN3N4B02□ | 3.4nH ±0.1nH | 500MHz | 14 | 500MHz | 450mA | 0.25Ω | 7000MHz |
| LQP03TN3N4C02□ | 3.4nH ±0.2nH | 500MHz | 14 | 500MHz | 450mA | 0.25Ω | 7000MHz |
| LQP03TN3N5B02□ | 3.5nH ±0.1nH | 500MHz | 14 | 500MHz | 450mA | 0.25Ω | 7000MHz |
| LQP03TN3N5C02□ | 3.5nH ±0.2nH | 500MHz | 14 | 500MHz | 450mA | 0.25Ω | 7000MHz |
| LQP03TN3N6B02□ | 3.6nH ±0.1nH | 500MHz | 14 | 500MHz | 400mA | 0.30Ω | 6000MHz |
| LQP03TN3N6C02□ | 3.6nH ±0.2nH | 500MHz | 14 | 500MHz | 400mA | 0.30Ω | 6000MHz |
| LQP03TN3N7B02□ | 3.7nH ±0.1nH | 500MHz | 14 | 500MHz | 400mA | 0.30Ω | 6000MHz |
| LQP03TN3N7C02□ | 3.7nH ±0.2nH | 500MHz | 14 | 500MHz | 400mA | 0.30Ω | 6000MHz |
| LQP03TN3N8B02□ | 3.8nH ±0.1nH | 500MHz | 14 | 500MHz | 400mA | 0.30Ω | 6000MHz |
| LQP03TN3N8C02□ | 3.8nH ±0.2nH | 500MHz | 14 | 500MHz | 400mA | 0.30Ω | 6000MHz |
| LQP03TN3N9B02□ | 3.9nH ±0.1nH | 500MHz | 14 | 500MHz | 400mA | 0.30Ω | 5700MHz |
| LQP03TN3N9C02□ | 3.9nH ±0.2nH | 500MHz | 14 | 500MHz | 400mA | 0.30Ω | 5700MHz |
| LQP03TN4N0B02□ | 4.0nH ±0.1nH | 500MHz | 14 | 500MHz | 350mA | 0.40Ω | 5300MHz |
| LQP03TN4N0C02□ | 4.0nH ±0.2nH | 500MHz | 14 | 500MHz | 350mA | 0.40Ω | 5300MHz |
| LQP03TN4N1B02□ | 4.1nH ±0.1nH | 500MHz | 14 | 500MHz | 350mA | 0.40Ω | 5300MHz |
| LQP03TN4N1C02□ | 4.1nH ±0.2nH | 500MHz | 14 | 500MHz | 350mA | 0.40Ω | 5300MHz |
| LQP03TN4N2B02□ | 4.2nH ±0.1nH | 500MHz | 14 | 500MHz | 350mA | 0.40Ω | 5300MHz |
| LQP03TN4N2C02□ | 4.2nH ±0.2nH | 500MHz | 14 | 500MHz | 350mA | 0.40Ω | 5300MHz |
| LQP03TN4N3H02□ | 4.3nH ±3% | 500MHz | 14 | 500MHz | 350mA | 0.40Ω | 5300MHz |
| LQP03TN4N3J02□ | 4.3nH ±5% | 500MHz | 14 | 500MHz | 350mA | 0.40Ω | 5300MHz |
| LQP03TN4N7H02□ | 4.7nH ±3% | 500MHz | 14 | 500MHz | 350mA | 0.40Ω | 4400MHz |
| LQP03TN4N7J02□ | 4.7nH ±5% | 500MHz | 14 | 500MHz | 350mA | 0.40Ω | 4400MHz |
| LQP03TN5N1H02□ | 5.1nH ±3% | 500MHz | 14 | 500MHz | 350mA | 0.40Ω | 4200MHz |
| LQP03TN5N1J02□ | 5.1nH ±5% | 500MHz | 14 | 500MHz | 350mA | 0.40Ω | 4200MHz |
| LQP03TN5N6H02□ | 5.6nH ±3% | 500MHz | 14 | 500MHz | 350mA | 0.40Ω | 4000MHz |
| LQP03TN5N6J02□ | 5.6nH ±5% | 500MHz | 14 | 500MHz | 350mA | 0.40Ω | 4000MHz |
| LQP03TN6N2H02□ | 6.2nH ±3% | 500MHz | 14 | 500MHz | 300mA | 0.60Ω | 4000MHz |
| LQP03TN6N2J02□ | 6.2nH ±5% | 500MHz | 14 | 500MHz | 300mA | 0.60Ω | 4000MHz |
| LQP03TN6N8H02□ | 6.8nH ±3% | 500MHz | 14 | 500MHz | 300mA | 0.60Ω | 3900MHz |
| LQP03TN6N8J02□ | 6.8nH ±5% | 500MHz | 14 | 500MHz | 300mA | 0.60Ω | 3900MHz |
| LQP03TN7N5H02□ | 7.5nH ±3% | 500MHz | 14 | 500MHz | 300mA | 0.60Ω | 3700MHz |
| LQP03TN7N5J02□ | 7.5nH ±5% | 500MHz | 14 | 500MHz | 300mA | 0.60Ω | 3700MHz |
| LQP03TN8N2H02□ | 8.2nH ±3% | 500MHz | 14 | 500MHz | 250mA | 0.70Ω | 3600MHz |
| LQP03TN8N2J02□ | 8.2nH ±5% | 500MHz | 14 | 500MHz | 250mA | 0.70Ω | 3600MHz |
| LQP03TN9N1H02□ | 9.1nH ±3% | 500MHz | 14 | 500MHz | 250mA | 0.70Ω | 3300MHz |
| LQP03TN9N1J02□ | 9.1nH ±5% | 500MHz | 14 | 500MHz | 250mA | 0.70Ω | 3300MHz |
| LQP03TN10NH02□ | 10nH ±3% | 500MHz | 14 | 500MHz | 250mA | 0.70Ω | 3200MHz |
| LQP03TN10NJ02□ | 10nH ±5% | 500MHz | 14 | 500MHz | 250mA | 0.70Ω | 3200MHz |
| LQP03TN11NH02□ | 11nH ±3% | 500MHz | 14 | 500MHz | 250mA | 0.80Ω | 2900MHz |
| LQP03TN11NJ02□ | 11nH ±5% | 500MHz | 14 | 500MHz | 250mA | 0.80Ω | 2900MHz |
| LQP03TN12NH02□ | 12nH ±3% | 500MHz | 12 | 500MHz | 250mA | 0.70Ω | 2900MHz |
| LQP03TN12NJ02□ | 12nH ±5% | 500MHz | 12 | 500MHz | 250mA | 0.70Ω | 2900MHz |
| LQP03TN13NH02□ | 13nH ±3% | 500MHz | 12 | 500MHz | 250mA | 0.80Ω | 2600MHz |
| LQP03TN13NJ02□ | 13nH ±5% | 500MHz | 12 | 500MHz | 250mA | 0.80Ω | 2600MHz |
| LQP03TN15NH02□ | 15nH ±3% | 500MHz | 12 | 500MHz | 250mA | 0.70Ω | 2600MHz |
| LQP03TN15NJ02□ | 15nH ±5% | 500MHz | 12 | 500MHz | 250mA | 0.70Ω | 2600MHz |
| LQP03TN16NH02□ | 16nH ±3% | 500MHz | 12 | 500MHz | 200mA | 0.95Ω | 2200MHz |
| LQP03TN16NJ02□ | 16nH ±5% | 500MHz | 12 | 500MHz | 200mA | 0.95Ω | 2200MHz |
| LQP03TN18NH02□ | 18nH ±3% | 500MHz | 12 | 500MHz | 200mA | 0.80Ω | 2200MHz |
| LQP03TN18NJ02□ | 18nH ±5% | 500MHz | 12 | 500MHz | 200mA | 0.80Ω | 2200MHz |

Operating temp. range: -55 to 125°C
 Only for reflow soldering
 *S.R.F.: Self Resonant Frequency

Continued on the following page. ↗

Continued from the preceding page. ↘

| Part Number (□: packaging code) | Inductance | Inductance Test Frequency | Q (min.) | Q Test Frequency | Rated Current | Max. of DC Resistance | S.R.F.* (min.) |
|------------------------------------|------------|------------------------------|----------|------------------|---------------|-----------------------|----------------|
| LQP03TN20NH02□ | 20nH ±3% | 500MHz | 12 | 500MHz | 150mA | 2.30Ω | 2200MHz |
| LQP03TN20NJ02□ | 20nH ±5% | 500MHz | 12 | 500MHz | 150mA | 2.30Ω | 2200MHz |
| LQP03TN22NH02□ | 22nH ±3% | 500MHz | 12 | 500MHz | 150mA | 1.90Ω | 2200MHz |
| LQP03TN22NJ02□ | 22nH ±5% | 500MHz | 12 | 500MHz | 150mA | 1.90Ω | 2200MHz |
| LQP03TN24NH02□ | 24nH ±3% | 500MHz | 12 | 500MHz | 140mA | 2.30Ω | 2000MHz |
| LQP03TN24NJ02□ | 24nH ±5% | 500MHz | 12 | 500MHz | 140mA | 2.30Ω | 2000MHz |
| LQP03TN27NH02□ | 27nH ±3% | 500MHz | 12 | 500MHz | 140mA | 2.30Ω | 2000MHz |
| LQP03TN27NJ02□ | 27nH ±5% | 500MHz | 12 | 500MHz | 140mA | 2.30Ω | 2000MHz |
| LQP03TN30NH02□ | 30nH ±3% | 500MHz | 9 | 500MHz | 120mA | 2.95Ω | 1700MHz |
| LQP03TN30NJ02□ | 30nH ±5% | 500MHz | 9 | 500MHz | 120mA | 2.95Ω | 1700MHz |
| LQP03TN33NH02□ | 33nH ±3% | 300MHz | 9 | 300MHz | 120mA | 2.95Ω | 1700MHz |
| LQP03TN33NJ02□ | 33nH ±5% | 300MHz | 9 | 300MHz | 120mA | 2.95Ω | 1700MHz |
| LQP03TN36NH02□ | 36nH ±3% | 300MHz | 9 | 300MHz | 120mA | 3.00Ω | 1500MHz |
| LQP03TN36NJ02□ | 36nH ±5% | 300MHz | 9 | 300MHz | 120mA | 3.00Ω | 1500MHz |
| LQP03TN39NH02□ | 39nH ±3% | 300MHz | 9 | 300MHz | 120mA | 3.00Ω | 1500MHz |
| LQP03TN39NJ02□ | 39nH ±5% | 300MHz | 9 | 300MHz | 120mA | 3.00Ω | 1500MHz |
| LQP03TN43NH02□ | 43nH ±3% | 300MHz | 9 | 300MHz | 100mA | 3.60Ω | 1300MHz |
| LQP03TN43NJ02□ | 43nH ±5% | 300MHz | 9 | 300MHz | 100mA | 3.60Ω | 1300MHz |
| LQP03TN47NH02□ | 47nH ±3% | 300MHz | 9 | 300MHz | 100mA | 3.60Ω | 1300MHz |
| LQP03TN47NJ02□ | 47nH ±5% | 300MHz | 9 | 300MHz | 100mA | 3.60Ω | 1300MHz |
| LQP03TN51NH02□ | 51nH ±3% | 300MHz | 9 | 300MHz | 100mA | 3.90Ω | 1200MHz |
| LQP03TN51NJ02□ | 51nH ±5% | 300MHz | 9 | 300MHz | 100mA | 3.90Ω | 1200MHz |
| LQP03TN56NH02□ | 56nH ±3% | 300MHz | 9 | 300MHz | 100mA | 3.90Ω | 1200MHz |
| LQP03TN56NJ02□ | 56nH ±5% | 300MHz | 9 | 300MHz | 100mA | 3.90Ω | 1200MHz |
| LQP03TN62NH02□ | 62nH ±3% | 300MHz | 8 | 300MHz | 100mA | 8Ω | 1100MHz |
| LQP03TN62NJ02□ | 62nH ±5% | 300MHz | 8 | 300MHz | 100mA | 8Ω | 1100MHz |
| LQP03TN68NH02□ | 68nH ±3% | 300MHz | 8 | 300MHz | 100mA | 8Ω | 1100MHz |
| LQP03TN68NJ02□ | 68nH ±5% | 300MHz | 8 | 300MHz | 100mA | 8Ω | 1100MHz |
| LQP03TN75NH02□ | 75nH ±3% | 300MHz | 8 | 300MHz | 100mA | 10Ω | 1000MHz |
| LQP03TN75NJ02□ | 75nH ±5% | 300MHz | 8 | 300MHz | 100mA | 10Ω | 1000MHz |
| LQP03TN82NH02□ | 82nH ±3% | 300MHz | 8 | 300MHz | 100mA | 10Ω | 1000MHz |
| LQP03TN82NJ02□ | 82nH ±5% | 300MHz | 8 | 300MHz | 100mA | 10Ω | 1000MHz |
| LQP03TN91NH02□ | 91nH ±3% | 300MHz | 8 | 300MHz | 80mA | 10Ω | 900MHz |
| LQP03TN91NJ02□ | 91nH ±5% | 300MHz | 8 | 300MHz | 80mA | 10Ω | 900MHz |
| LQP03TNR10H02□ | 100nH ±3% | 300MHz | 8 | 300MHz | 80mA | 10Ω | 900MHz |
| LQP03TNR10J02□ | 100nH ±5% | 300MHz | 8 | 300MHz | 80mA | 10Ω | 900MHz |
| LQP03TNR11H02□ | 110nH ±3% | 300MHz | 8 | 300MHz | 80mA | 12Ω | 800MHz |
| LQP03TNR11J02□ | 110nH ±5% | 300MHz | 8 | 300MHz | 80mA | 12Ω | 800MHz |
| LQP03TNR12H02□ | 120nH ±3% | 300MHz | 8 | 300MHz | 80mA | 12Ω | 800MHz |
| LQP03TNR12J02□ | 120nH ±5% | 300MHz | 8 | 300MHz | 80mA | 12Ω | 800MHz |
| LQP03TNR13H02□ | 130nH ±3% | 100MHz | 5 | 100MHz | 80mA | 9Ω | 650MHz |
| LQP03TNR13J02□ | 130nH ±5% | 100MHz | 5 | 100MHz | 80mA | 9Ω | 650MHz |
| LQP03TNR15H02□ | 150nH ±3% | 100MHz | 5 | 100MHz | 80mA | 9Ω | 650MHz |
| LQP03TNR15J02□ | 150nH ±5% | 100MHz | 5 | 100MHz | 80mA | 9Ω | 650MHz |
| LQP03TNR16H02□ | 160nH ±3% | 100MHz | 5 | 100MHz | 70mA | 11Ω | 600MHz |
| LQP03TNR16J02□ | 160nH ±5% | 100MHz | 5 | 100MHz | 70mA | 11Ω | 600MHz |
| LQP03TNR18H02□ | 180nH ±3% | 100MHz | 5 | 100MHz | 70mA | 11Ω | 600MHz |
| LQP03TNR18J02□ | 180nH ±5% | 100MHz | 5 | 100MHz | 70mA | 11Ω | 600MHz |
| LQP03TNR20H02□ | 200nH ±3% | 100MHz | 5 | 100MHz | 60mA | 13Ω | 500MHz |
| LQP03TNR20J02□ | 200nH ±5% | 100MHz | 5 | 100MHz | 60mA | 13Ω | 500MHz |
| LQP03TNR22H02□ | 220nH ±3% | 100MHz | 5 | 100MHz | 60mA | 13Ω | 500MHz |
| LQP03TNR22J02□ | 220nH ±5% | 100MHz | 5 | 100MHz | 60mA | 13Ω | 500MHz |
| LQP03TNR24H02□ | 240nH ±3% | 100MHz | 5 | 100MHz | 60mA | 15Ω | 450MHz |

Operating temp. range: -55 to 125°C
 Only for reflow soldering
 *S.R.F.: Self Resonant Frequency

Continued on the following page. ↗

Continued from the preceding page. ↘

| Part Number (□: packaging code) | Inductance | Inductance Test Frequency | Q (min.) | Q Test Frequency | Rated Current | Max. of DC Resistance | S.R.F.* (min.) |
|------------------------------------|------------|---------------------------|----------|------------------|---------------|-----------------------|----------------|
| LQP03TNR24J02□ | 240nH ±5% | 100MHz | 5 | 100MHz | 60mA | 15Ω | 450MHz |
| LQP03TNR27H02□ | 270nH ±3% | 100MHz | 5 | 100MHz | 60mA | 15Ω | 450MHz |
| LQP03TNR27J02□ | 270nH ±5% | 100MHz | 5 | 100MHz | 60mA | 15Ω | 450MHz |

Operating temp. range: -55 to 125°C
 Only for reflow soldering
 *S.R.F.: Self Resonant Frequency

Inductance-Frequency Characteristics (Typ.)

Q-Frequency Characteristics (Typ.)



LQP03TQ_02 Series 0201 (0603) inch (mm)



| Packaging Code | Packaging | Minimum Quantity |
|----------------|---------------------|------------------|
| D | ø180mm Paper Taping | 15000 |
| J | ø330mm Paper Taping | 50000 |
| B | Packing in Bulk | 500 |

| Part Number (□: packaging code) | Inductance | Inductance Test Frequency | Q (min.) | Q Test Frequency | Rated Current | Max. of DC Resistance | S.R.F.* (min.) |
|------------------------------------|---------------|---------------------------|----------|------------------|---------------|-----------------------|----------------|
| LQP03TQ0N6W02□ | 0.6nH ±0.05nH | 500MHz | 17 | 500MHz | 1000mA | 0.05Ω | 20000MHz |
| LQP03TQ0N6B02□ | 0.6nH ±0.1nH | 500MHz | 17 | 500MHz | 1000mA | 0.05Ω | 20000MHz |
| LQP03TQ0N6C02□ | 0.6nH ±0.2nH | 500MHz | 17 | 500MHz | 1000mA | 0.05Ω | 20000MHz |
| LQP03TQ0N7W02□ | 0.7nH ±0.05nH | 500MHz | 17 | 500MHz | 1000mA | 0.05Ω | 20000MHz |
| LQP03TQ0N7B02□ | 0.7nH ±0.1nH | 500MHz | 17 | 500MHz | 1000mA | 0.05Ω | 20000MHz |
| LQP03TQ0N7C02□ | 0.7nH ±0.2nH | 500MHz | 17 | 500MHz | 1000mA | 0.05Ω | 20000MHz |
| LQP03TQ0N8W02□ | 0.8nH ±0.05nH | 500MHz | 17 | 500MHz | 1000mA | 0.05Ω | 18000MHz |
| LQP03TQ0N8B02□ | 0.8nH ±0.1nH | 500MHz | 17 | 500MHz | 1000mA | 0.05Ω | 18000MHz |
| LQP03TQ0N8C02□ | 0.8nH ±0.2nH | 500MHz | 17 | 500MHz | 1000mA | 0.05Ω | 18000MHz |
| LQP03TQ0N9W02□ | 0.9nH ±0.05nH | 500MHz | 17 | 500MHz | 800mA | 0.08Ω | 18000MHz |
| LQP03TQ0N9B02□ | 0.9nH ±0.1nH | 500MHz | 17 | 500MHz | 800mA | 0.08Ω | 18000MHz |
| LQP03TQ0N9C02□ | 0.9nH ±0.2nH | 500MHz | 17 | 500MHz | 800mA | 0.08Ω | 18000MHz |
| LQP03TQ1N0W02□ | 1.0nH ±0.05nH | 500MHz | 17 | 500MHz | 800mA | 0.08Ω | 17000MHz |
| LQP03TQ1N0B02□ | 1.0nH ±0.1nH | 500MHz | 17 | 500MHz | 800mA | 0.08Ω | 17000MHz |
| LQP03TQ1N0C02□ | 1.0nH ±0.2nH | 500MHz | 17 | 500MHz | 800mA | 0.08Ω | 17000MHz |
| LQP03TQ1N1W02□ | 1.1nH ±0.05nH | 500MHz | 17 | 500MHz | 800mA | 0.08Ω | 17000MHz |
| LQP03TQ1N1B02□ | 1.1nH ±0.1nH | 500MHz | 17 | 500MHz | 800mA | 0.08Ω | 17000MHz |

Operating temp. range: -55 to 125°C
 Only for reflow soldering
 *S.R.F.: Self Resonant Frequency

Continued on the following page. ↗

Inductors for Power Lines

Inductors for General Circuits

RF Inductors
LQP03TQ_02

Continued from the preceding page. ↘

| Part Number (□: packaging code) | Inductance | Inductance Test Frequency | Q (min.) | Q Test Frequency | Rated Current | Max. of DC Resistance | S.R.F.* (min.) |
|------------------------------------|---------------|------------------------------|----------|------------------|---------------|-----------------------|----------------|
| LQP03TQ1N1C02□ | 1.1nH ±0.2nH | 500MHz | 17 | 500MHz | 800mA | 0.08Ω | 17000MHz |
| LQP03TQ1N2W02□ | 1.2nH ±0.05nH | 500MHz | 17 | 500MHz | 800mA | 0.08Ω | 17000MHz |
| LQP03TQ1N2B02□ | 1.2nH ±0.1nH | 500MHz | 17 | 500MHz | 800mA | 0.08Ω | 17000MHz |
| LQP03TQ1N2C02□ | 1.2nH ±0.2nH | 500MHz | 17 | 500MHz | 800mA | 0.08Ω | 17000MHz |
| LQP03TQ1N3W02□ | 1.3nH ±0.05nH | 500MHz | 17 | 500MHz | 700mA | 0.1Ω | 17000MHz |
| LQP03TQ1N3B02□ | 1.3nH ±0.1nH | 500MHz | 17 | 500MHz | 700mA | 0.1Ω | 17000MHz |
| LQP03TQ1N3C02□ | 1.3nH ±0.2nH | 500MHz | 17 | 500MHz | 700mA | 0.1Ω | 17000MHz |
| LQP03TQ1N4W02□ | 1.4nH ±0.05nH | 500MHz | 17 | 500MHz | 700mA | 0.1Ω | 16000MHz |
| LQP03TQ1N4B02□ | 1.4nH ±0.1nH | 500MHz | 17 | 500MHz | 700mA | 0.1Ω | 16000MHz |
| LQP03TQ1N4C02□ | 1.4nH ±0.2nH | 500MHz | 17 | 500MHz | 700mA | 0.1Ω | 16000MHz |
| LQP03TQ1N5W02□ | 1.5nH ±0.05nH | 500MHz | 17 | 500MHz | 650mA | 0.1Ω | 15000MHz |
| LQP03TQ1N5B02□ | 1.5nH ±0.1nH | 500MHz | 17 | 500MHz | 650mA | 0.1Ω | 15000MHz |
| LQP03TQ1N5C02□ | 1.5nH ±0.2nH | 500MHz | 17 | 500MHz | 650mA | 0.1Ω | 15000MHz |
| LQP03TQ1N6B02□ | 1.6nH ±0.1nH | 500MHz | 17 | 500MHz | 650mA | 0.1Ω | 15000MHz |
| LQP03TQ1N6C02□ | 1.6nH ±0.2nH | 500MHz | 17 | 500MHz | 650mA | 0.1Ω | 15000MHz |
| LQP03TQ1N7B02□ | 1.7nH ±0.1nH | 500MHz | 17 | 500MHz | 650mA | 0.1Ω | 15000MHz |
| LQP03TQ1N7C02□ | 1.7nH ±0.2nH | 500MHz | 17 | 500MHz | 650mA | 0.1Ω | 15000MHz |
| LQP03TQ1N8B02□ | 1.8nH ±0.1nH | 500MHz | 17 | 500MHz | 650mA | 0.1Ω | 15000MHz |
| LQP03TQ1N8C02□ | 1.8nH ±0.2nH | 500MHz | 17 | 500MHz | 650mA | 0.1Ω | 15000MHz |
| LQP03TQ1N9B02□ | 1.9nH ±0.1nH | 500MHz | 17 | 500MHz | 650mA | 0.1Ω | 12500MHz |
| LQP03TQ1N9C02□ | 1.9nH ±0.2nH | 500MHz | 17 | 500MHz | 650mA | 0.1Ω | 12500MHz |
| LQP03TQ2N0B02□ | 2.0nH ±0.1nH | 500MHz | 17 | 500MHz | 650mA | 0.1Ω | 12500MHz |
| LQP03TQ2N0C02□ | 2.0nH ±0.2nH | 500MHz | 17 | 500MHz | 650mA | 0.1Ω | 12500MHz |
| LQP03TQ2N1B02□ | 2.1nH ±0.1nH | 500MHz | 17 | 500MHz | 650mA | 0.12Ω | 11000MHz |
| LQP03TQ2N1C02□ | 2.1nH ±0.2nH | 500MHz | 17 | 500MHz | 650mA | 0.12Ω | 11000MHz |
| LQP03TQ2N2B02□ | 2.2nH ±0.1nH | 500MHz | 17 | 500MHz | 650mA | 0.12Ω | 11000MHz |
| LQP03TQ2N2C02□ | 2.2nH ±0.2nH | 500MHz | 17 | 500MHz | 650mA | 0.12Ω | 11000MHz |
| LQP03TQ2N3B02□ | 2.3nH ±0.1nH | 500MHz | 17 | 500MHz | 550mA | 0.15Ω | 11000MHz |
| LQP03TQ2N3C02□ | 2.3nH ±0.2nH | 500MHz | 17 | 500MHz | 550mA | 0.15Ω | 11000MHz |
| LQP03TQ2N4B02□ | 2.4nH ±0.1nH | 500MHz | 17 | 500MHz | 550mA | 0.15Ω | 11000MHz |
| LQP03TQ2N4C02□ | 2.4nH ±0.2nH | 500MHz | 17 | 500MHz | 550mA | 0.15Ω | 11000MHz |
| LQP03TQ2N5B02□ | 2.5nH ±0.1nH | 500MHz | 17 | 500MHz | 550mA | 0.15Ω | 10000MHz |
| LQP03TQ2N5C02□ | 2.5nH ±0.2nH | 500MHz | 17 | 500MHz | 550mA | 0.15Ω | 10000MHz |
| LQP03TQ2N6B02□ | 2.6nH ±0.1nH | 500MHz | 17 | 500MHz | 550mA | 0.15Ω | 10000MHz |
| LQP03TQ2N6C02□ | 2.6nH ±0.2nH | 500MHz | 17 | 500MHz | 550mA | 0.15Ω | 10000MHz |
| LQP03TQ2N7B02□ | 2.7nH ±0.1nH | 500MHz | 17 | 500MHz | 550mA | 0.15Ω | 10000MHz |
| LQP03TQ2N7C02□ | 2.7nH ±0.2nH | 500MHz | 17 | 500MHz | 550mA | 0.15Ω | 10000MHz |
| LQP03TQ2N8B02□ | 2.8nH ±0.1nH | 500MHz | 17 | 500MHz | 500mA | 0.2Ω | 10000MHz |
| LQP03TQ2N8C02□ | 2.8nH ±0.2nH | 500MHz | 17 | 500MHz | 500mA | 0.2Ω | 10000MHz |
| LQP03TQ2N9B02□ | 2.9nH ±0.1nH | 500MHz | 17 | 500MHz | 500mA | 0.2Ω | 10000MHz |
| LQP03TQ2N9C02□ | 2.9nH ±0.2nH | 500MHz | 17 | 500MHz | 500mA | 0.2Ω | 10000MHz |
| LQP03TQ3N0B02□ | 3.0nH ±0.1nH | 500MHz | 17 | 500MHz | 500mA | 0.2Ω | 9500MHz |
| LQP03TQ3N0C02□ | 3.0nH ±0.2nH | 500MHz | 17 | 500MHz | 500mA | 0.2Ω | 9500MHz |
| LQP03TQ3N1B02□ | 3.1nH ±0.1nH | 500MHz | 17 | 500MHz | 450mA | 0.24Ω | 9500MHz |
| LQP03TQ3N1C02□ | 3.1nH ±0.2nH | 500MHz | 17 | 500MHz | 450mA | 0.24Ω | 9500MHz |
| LQP03TQ3N2B02□ | 3.2nH ±0.1nH | 500MHz | 17 | 500MHz | 450mA | 0.24Ω | 9500MHz |
| LQP03TQ3N2C02□ | 3.2nH ±0.2nH | 500MHz | 17 | 500MHz | 450mA | 0.24Ω | 9500MHz |
| LQP03TQ3N3B02□ | 3.3nH ±0.1nH | 500MHz | 17 | 500MHz | 450mA | 0.24Ω | 9500MHz |
| LQP03TQ3N3C02□ | 3.3nH ±0.2nH | 500MHz | 17 | 500MHz | 450mA | 0.24Ω | 9500MHz |
| LQP03TQ3N4B02□ | 3.4nH ±0.1nH | 500MHz | 17 | 500MHz | 450mA | 0.25Ω | 8000MHz |
| LQP03TQ3N4C02□ | 3.4nH ±0.2nH | 500MHz | 17 | 500MHz | 450mA | 0.25Ω | 8000MHz |
| LQP03TQ3N5B02□ | 3.5nH ±0.1nH | 500MHz | 17 | 500MHz | 450mA | 0.25Ω | 8000MHz |
| LQP03TQ3N5C02□ | 3.5nH ±0.2nH | 500MHz | 17 | 500MHz | 450mA | 0.25Ω | 8000MHz |

Operating temp. range: -55 to 125°C
 Only for reflow soldering
 *S.R.F.: Self Resonant Frequency

Continued on the following page. ↗

Inductors for Power Lines

Inductors for General Circuits

LQP03TQ_02
RF Inductors

Continued from the preceding page. ↘

| Part Number (□: packaging code) | Inductance | Inductance Test Frequency | Q (min.) | Q Test Frequency | Rated Current | Max. of DC Resistance | S.R.F.* (min.) |
|------------------------------------|--------------|------------------------------|----------|------------------|---------------|-----------------------|----------------|
| LQP03TQ3N6B02□ | 3.6nH ±0.1nH | 500MHz | 17 | 500MHz | 400mA | 0.25Ω | 8000MHz |
| LQP03TQ3N6C02□ | 3.6nH ±0.2nH | 500MHz | 17 | 500MHz | 400mA | 0.25Ω | 8000MHz |
| LQP03TQ3N7B02□ | 3.7nH ±0.1nH | 500MHz | 17 | 500MHz | 400mA | 0.25Ω | 6500MHz |
| LQP03TQ3N7C02□ | 3.7nH ±0.2nH | 500MHz | 17 | 500MHz | 400mA | 0.25Ω | 6500MHz |
| LQP03TQ3N8B02□ | 3.8nH ±0.1nH | 500MHz | 17 | 500MHz | 400mA | 0.25Ω | 6500MHz |
| LQP03TQ3N8C02□ | 3.8nH ±0.2nH | 500MHz | 17 | 500MHz | 400mA | 0.25Ω | 6500MHz |
| LQP03TQ3N9B02□ | 3.9nH ±0.1nH | 500MHz | 17 | 500MHz | 400mA | 0.25Ω | 6500MHz |
| LQP03TQ3N9C02□ | 3.9nH ±0.2nH | 500MHz | 17 | 500MHz | 400mA | 0.25Ω | 6500MHz |
| LQP03TQ4N0B02□ | 4.0nH ±0.1nH | 500MHz | 17 | 500MHz | 360mA | 0.35Ω | 6500MHz |
| LQP03TQ4N0C02□ | 4.0nH ±0.2nH | 500MHz | 17 | 500MHz | 360mA | 0.35Ω | 6500MHz |
| LQP03TQ4N1B02□ | 4.1nH ±0.1nH | 500MHz | 17 | 500MHz | 360mA | 0.35Ω | 6500MHz |
| LQP03TQ4N1C02□ | 4.1nH ±0.2nH | 500MHz | 17 | 500MHz | 360mA | 0.35Ω | 6500MHz |
| LQP03TQ4N2B02□ | 4.2nH ±0.1nH | 500MHz | 17 | 500MHz | 360mA | 0.35Ω | 6500MHz |
| LQP03TQ4N2C02□ | 4.2nH ±0.2nH | 500MHz | 17 | 500MHz | 360mA | 0.35Ω | 6500MHz |
| LQP03TQ4N3H02□ | 4.3nH ±3% | 500MHz | 17 | 500MHz | 360mA | 0.35Ω | 6500MHz |
| LQP03TQ4N3J02□ | 4.3nH ±5% | 500MHz | 17 | 500MHz | 360mA | 0.35Ω | 6500MHz |
| LQP03TQ4N7H02□ | 4.7nH ±3% | 500MHz | 17 | 500MHz | 350mA | 0.35Ω | 6500MHz |
| LQP03TQ4N7J02□ | 4.7nH ±5% | 500MHz | 17 | 500MHz | 350mA | 0.35Ω | 6500MHz |
| LQP03TQ5N1H02□ | 5.1nH ±3% | 500MHz | 17 | 500MHz | 350mA | 0.39Ω | 6500MHz |
| LQP03TQ5N1J02□ | 5.1nH ±5% | 500MHz | 17 | 500MHz | 350mA | 0.39Ω | 6500MHz |
| LQP03TQ5N6H02□ | 5.6nH ±3% | 500MHz | 17 | 500MHz | 350mA | 0.39Ω | 6000MHz |
| LQP03TQ5N6J02□ | 5.6nH ±5% | 500MHz | 17 | 500MHz | 350mA | 0.39Ω | 6000MHz |
| LQP03TQ6N2H02□ | 6.2nH ±3% | 500MHz | 17 | 500MHz | 300mA | 0.55Ω | 6000MHz |
| LQP03TQ6N2J02□ | 6.2nH ±5% | 500MHz | 17 | 500MHz | 300mA | 0.55Ω | 6000MHz |
| LQP03TQ6N8H02□ | 6.8nH ±3% | 500MHz | 17 | 500MHz | 300mA | 0.55Ω | 5400MHz |
| LQP03TQ6N8J02□ | 6.8nH ±5% | 500MHz | 17 | 500MHz | 300mA | 0.55Ω | 5400MHz |
| LQP03TQ7N5H02□ | 7.5nH ±3% | 500MHz | 17 | 500MHz | 300mA | 0.55Ω | 4800MHz |
| LQP03TQ7N5J02□ | 7.5nH ±5% | 500MHz | 17 | 500MHz | 300mA | 0.55Ω | 4800MHz |
| LQP03TQ8N2H02□ | 8.2nH ±3% | 500MHz | 17 | 500MHz | 250mA | 0.65Ω | 4800MHz |
| LQP03TQ8N2J02□ | 8.2nH ±5% | 500MHz | 17 | 500MHz | 250mA | 0.65Ω | 4800MHz |
| LQP03TQ9N1H02□ | 9.1nH ±3% | 500MHz | 17 | 500MHz | 250mA | 0.65Ω | 4500MHz |
| LQP03TQ9N1J02□ | 9.1nH ±5% | 500MHz | 17 | 500MHz | 250mA | 0.65Ω | 4500MHz |
| LQP03TQ10NH02□ | 10nH ±3% | 500MHz | 17 | 500MHz | 250mA | 0.69Ω | 4500MHz |
| LQP03TQ10NJ02□ | 10nH ±5% | 500MHz | 17 | 500MHz | 250mA | 0.69Ω | 4500MHz |
| LQP03TQ11NH02□ | 11nH ±3% | 500MHz | 17 | 500MHz | 250mA | 0.69Ω | 3700MHz |
| LQP03TQ11NJ02□ | 11nH ±5% | 500MHz | 17 | 500MHz | 250mA | 0.69Ω | 3700MHz |
| LQP03TQ12NH02□ | 12nH ±3% | 500MHz | 17 | 500MHz | 250mA | 0.69Ω | 3700MHz |
| LQP03TQ12NJ02□ | 12nH ±5% | 500MHz | 17 | 500MHz | 250mA | 0.69Ω | 3700MHz |
| LQP03TQ13NH02□ | 13nH ±3% | 500MHz | 17 | 500MHz | 250mA | 0.69Ω | 3700MHz |
| LQP03TQ13NJ02□ | 13nH ±5% | 500MHz | 17 | 500MHz | 250mA | 0.69Ω | 3700MHz |
| LQP03TQ15NH02□ | 15nH ±3% | 500MHz | 14 | 500MHz | 250mA | 0.8Ω | 3500MHz |
| LQP03TQ15NJ02□ | 15nH ±5% | 500MHz | 14 | 500MHz | 250mA | 0.8Ω | 3500MHz |
| LQP03TQ16NH02□ | 16nH ±3% | 500MHz | 14 | 500MHz | 250mA | 0.8Ω | 3500MHz |
| LQP03TQ16NJ02□ | 16nH ±5% | 500MHz | 14 | 500MHz | 250mA | 0.8Ω | 3500MHz |
| LQP03TQ18NH02□ | 18nH ±3% | 500MHz | 14 | 500MHz | 200mA | 1.1Ω | 3500MHz |
| LQP03TQ18NJ02□ | 18nH ±5% | 500MHz | 14 | 500MHz | 200mA | 1.1Ω | 3500MHz |
| LQP03TQ20NH02□ | 20nH ±3% | 500MHz | 14 | 500MHz | 200mA | 1.2Ω | 3000MHz |
| LQP03TQ20NJ02□ | 20nH ±5% | 500MHz | 14 | 500MHz | 200mA | 1.2Ω | 3000MHz |
| LQP03TQ22NH02□ | 22nH ±3% | 500MHz | 14 | 500MHz | 200mA | 1.2Ω | 3000MHz |
| LQP03TQ22NJ02□ | 22nH ±5% | 500MHz | 14 | 500MHz | 200mA | 1.2Ω | 3000MHz |
| LQP03TQ24NH02□ | 24nH ±3% | 500MHz | 14 | 500MHz | 150mA | 1.6Ω | 2000MHz |
| LQP03TQ24NJ02□ | 24nH ±5% | 500MHz | 14 | 500MHz | 150mA | 1.6Ω | 2000MHz |
| LQP03TQ27NH02□ | 27nH ±3% | 500MHz | 14 | 500MHz | 150mA | 1.6Ω | 2000MHz |

Operating temp. range: -55 to 125°C
 Only for reflow soldering
 *S.R.F.: Self Resonant Frequency

Continued on the following page. ↗

Continued from the preceding page. ↘

| Part Number (□: packaging code) | Inductance | Inductance Test Frequency | Q (min.) | Q Test Frequency | Rated Current | Max. of DC Resistance | S.R.F.* (min.) |
|------------------------------------|------------|------------------------------|----------|------------------|---------------|-----------------------|----------------|
| LQP03TQ27NJ02□ | 27nH ±5% | 500MHz | 14 | 500MHz | 150mA | 1.6Ω | 2000MHz |
| LQP03TQ30NH02□ | 30nH ±3% | 500MHz | 11 | 500MHz | 150mA | 2Ω | 1700MHz |
| LQP03TQ30NJ02□ | 30nH ±5% | 500MHz | 11 | 500MHz | 150mA | 2Ω | 1700MHz |
| LQP03TQ33NH02□ | 33nH ±3% | 300MHz | 11 | 300MHz | 150mA | 2Ω | 1700MHz |
| LQP03TQ33NJ02□ | 33nH ±5% | 300MHz | 11 | 300MHz | 150mA | 2Ω | 1700MHz |
| LQP03TQ36NH02□ | 36nH ±3% | 300MHz | 11 | 300MHz | 130mA | 2.5Ω | 1500MHz |
| LQP03TQ36NJ02□ | 36nH ±5% | 300MHz | 11 | 300MHz | 130mA | 2.5Ω | 1500MHz |
| LQP03TQ39NH02□ | 39nH ±3% | 300MHz | 11 | 300MHz | 130mA | 2.5Ω | 1500MHz |
| LQP03TQ39NJ02□ | 39nH ±5% | 300MHz | 11 | 300MHz | 130mA | 2.5Ω | 1500MHz |
| LQP03TQ43NH02□ | 43nH ±3% | 300MHz | 11 | 300MHz | 130mA | 4Ω | 1300MHz |
| LQP03TQ43NJ02□ | 43nH ±5% | 300MHz | 11 | 300MHz | 130mA | 4Ω | 1300MHz |
| LQP03TQ47NH02□ | 47nH ±3% | 300MHz | 11 | 300MHz | 130mA | 4Ω | 1300MHz |
| LQP03TQ47NJ02□ | 47nH ±5% | 300MHz | 11 | 300MHz | 130mA | 4Ω | 1300MHz |
| LQP03TQ51NH02□ | 51nH ±3% | 300MHz | 11 | 300MHz | 100mA | 6Ω | 1200MHz |
| LQP03TQ51NJ02□ | 51nH ±5% | 300MHz | 11 | 300MHz | 100mA | 6Ω | 1200MHz |
| LQP03TQ56NH02□ | 56nH ±3% | 300MHz | 11 | 300MHz | 100mA | 6Ω | 1200MHz |
| LQP03TQ56NJ02□ | 56nH ±5% | 300MHz | 11 | 300MHz | 100mA | 6Ω | 1200MHz |
| LQP03TQ62NH02□ | 62nH ±3% | 300MHz | 9 | 300MHz | 80mA | 7Ω | 1100MHz |
| LQP03TQ62NJ02□ | 62nH ±5% | 300MHz | 9 | 300MHz | 80mA | 7Ω | 1100MHz |
| LQP03TQ68NH02□ | 68nH ±3% | 300MHz | 9 | 300MHz | 80mA | 7Ω | 1100MHz |
| LQP03TQ68NJ02□ | 68nH ±5% | 300MHz | 9 | 300MHz | 80mA | 7Ω | 1100MHz |
| LQP03TQ75NH02□ | 75nH ±3% | 300MHz | 9 | 300MHz | 80mA | 7Ω | 1100MHz |
| LQP03TQ75NJ02□ | 75nH ±5% | 300MHz | 9 | 300MHz | 80mA | 7Ω | 1100MHz |
| LQP03TQ82NH02□ | 82nH ±3% | 300MHz | 9 | 300MHz | 80mA | 7Ω | 1000MHz |
| LQP03TQ82NJ02□ | 82nH ±5% | 300MHz | 9 | 300MHz | 80mA | 7Ω | 1000MHz |
| LQP03TQ91NH02□ | 91nH ±3% | 300MHz | 9 | 300MHz | 70mA | 8Ω | 1000MHz |
| LQP03TQ91NJ02□ | 91nH ±5% | 300MHz | 9 | 300MHz | 70mA | 8Ω | 1000MHz |
| LQP03TQR10H02□ | 100nH ±3% | 300MHz | 9 | 300MHz | 70mA | 9Ω | 900MHz |
| LQP03TQR10J02□ | 100nH ±5% | 300MHz | 9 | 300MHz | 70mA | 9Ω | 900MHz |
| LQP03TQR11H02□ | 110nH ±3% | 300MHz | 9 | 300MHz | 70mA | 9Ω | 900MHz |
| LQP03TQR11J02□ | 110nH ±5% | 300MHz | 9 | 300MHz | 70mA | 9Ω | 900MHz |

Operating temp. range: -55 to 125°C

Only for reflow soldering

*S.R.F.: Self Resonant Frequency

Inductance-Frequency Characteristics (Typ.)



Q-Frequency Characteristics (Typ.)



LQP15MN_02 Series 0402 (1005) inch (mm)



| Packaging Code | Packaging | Minimum Quantity |
|----------------|---------------------|------------------|
| D | ø180mm Paper Taping | 10000 |
| J | ø330mm Paper Taping | 50000 |
| B | Packing in Bulk | 500 |

| Part Number (□: packaging code) | Inductance | Inductance Test Frequency | Q (min.) | Q Test Frequency | Rated Current | Max. of DC Resistance | S.R.F.* (min.) |
|------------------------------------|---------------|------------------------------|----------|------------------|---------------|-----------------------|----------------|
| LQP15MN1N0W02□ | 1.0nH ±0.05nH | 500MHz | 13 | 500MHz | 400mA | 0.1Ω | 6000MHz |
| LQP15MN1N0B02□ | 1.0nH ±0.1nH | 500MHz | 13 | 500MHz | 400mA | 0.1Ω | 6000MHz |
| LQP15MN1N1W02□ | 1.1nH ±0.05nH | 500MHz | 13 | 500MHz | 390mA | 0.1Ω | 6000MHz |
| LQP15MN1N1B02□ | 1.1nH ±0.1nH | 500MHz | 13 | 500MHz | 390mA | 0.1Ω | 6000MHz |
| LQP15MN1N2W02□ | 1.2nH ±0.05nH | 500MHz | 13 | 500MHz | 390mA | 0.1Ω | 6000MHz |
| LQP15MN1N2B02□ | 1.2nH ±0.1nH | 500MHz | 13 | 500MHz | 390mA | 0.1Ω | 6000MHz |
| LQP15MN1N3W02□ | 1.3nH ±0.05nH | 500MHz | 13 | 500MHz | 280mA | 0.2Ω | 6000MHz |
| LQP15MN1N3B02□ | 1.3nH ±0.1nH | 500MHz | 13 | 500MHz | 280mA | 0.2Ω | 6000MHz |
| LQP15MN1N4W02□ | 1.4nH ±0.05nH | 500MHz | 13 | 500MHz | 280mA | 0.2Ω | 6000MHz |
| LQP15MN1N5W02□ | 1.5nH ±0.05nH | 500MHz | 13 | 500MHz | 280mA | 0.2Ω | 6000MHz |
| LQP15MN1N5B02□ | 1.5nH ±0.1nH | 500MHz | 13 | 500MHz | 280mA | 0.2Ω | 6000MHz |
| LQP15MN1N6W02□ | 1.6nH ±0.05nH | 500MHz | 13 | 500MHz | 220mA | 0.3Ω | 6000MHz |
| LQP15MN1N6B02□ | 1.6nH ±0.1nH | 500MHz | 13 | 500MHz | 220mA | 0.3Ω | 6000MHz |
| LQP15MN1N7W02□ | 1.7nH ±0.05nH | 500MHz | 13 | 500MHz | 280mA | 0.2Ω | 6000MHz |
| LQP15MN1N8W02□ | 1.8nH ±0.05nH | 500MHz | 13 | 500MHz | 280mA | 0.2Ω | 6000MHz |
| LQP15MN1N8B02□ | 1.8nH ±0.1nH | 500MHz | 13 | 500MHz | 280mA | 0.2Ω | 6000MHz |
| LQP15MN1N9W02□ | 1.9nH ±0.05nH | 500MHz | 13 | 500MHz | 220mA | 0.3Ω | 6000MHz |
| LQP15MN2N0W02□ | 2.0nH ±0.05nH | 500MHz | 13 | 500MHz | 220mA | 0.3Ω | 6000MHz |
| LQP15MN2N0B02□ | 2.0nH ±0.1nH | 500MHz | 13 | 500MHz | 220mA | 0.3Ω | 6000MHz |
| LQP15MN2N1W02□ | 2.1nH ±0.05nH | 500MHz | 13 | 500MHz | 220mA | 0.3Ω | 6000MHz |
| LQP15MN2N2W02□ | 2.2nH ±0.05nH | 500MHz | 13 | 500MHz | 220mA | 0.3Ω | 6000MHz |
| LQP15MN2N2B02□ | 2.2nH ±0.1nH | 500MHz | 13 | 500MHz | 220mA | 0.3Ω | 6000MHz |
| LQP15MN2N3W02□ | 2.3nH ±0.05nH | 500MHz | 13 | 500MHz | 220mA | 0.3Ω | 6000MHz |
| LQP15MN2N4W02□ | 2.4nH ±0.05nH | 500MHz | 13 | 500MHz | 220mA | 0.3Ω | 6000MHz |
| LQP15MN2N4B02□ | 2.4nH ±0.1nH | 500MHz | 13 | 500MHz | 220mA | 0.3Ω | 6000MHz |
| LQP15MN2N5W02□ | 2.5nH ±0.05nH | 500MHz | 13 | 500MHz | 220mA | 0.3Ω | 6000MHz |
| LQP15MN2N6W02□ | 2.6nH ±0.05nH | 500MHz | 13 | 500MHz | 220mA | 0.3Ω | 6000MHz |
| LQP15MN2N7W02□ | 2.7nH ±0.05nH | 500MHz | 13 | 500MHz | 220mA | 0.3Ω | 6000MHz |
| LQP15MN2N7B02□ | 2.7nH ±0.1nH | 500MHz | 13 | 500MHz | 220mA | 0.3Ω | 6000MHz |
| LQP15MN2N8W02□ | 2.8nH ±0.05nH | 500MHz | 13 | 500MHz | 190mA | 0.4Ω | 6000MHz |
| LQP15MN2N9W02□ | 2.9nH ±0.05nH | 500MHz | 13 | 500MHz | 190mA | 0.4Ω | 6000MHz |
| LQP15MN3N0W02□ | 3.0nH ±0.05nH | 500MHz | 13 | 500MHz | 190mA | 0.4Ω | 6000MHz |
| LQP15MN3N0B02□ | 3.0nH ±0.1nH | 500MHz | 13 | 500MHz | 190mA | 0.4Ω | 6000MHz |
| LQP15MN3N1W02□ | 3.1nH ±0.05nH | 500MHz | 13 | 500MHz | 190mA | 0.4Ω | 6000MHz |
| LQP15MN3N2W02□ | 3.2nH ±0.05nH | 500MHz | 13 | 500MHz | 190mA | 0.4Ω | 6000MHz |
| LQP15MN3N3W02□ | 3.3nH ±0.05nH | 500MHz | 13 | 500MHz | 190mA | 0.4Ω | 6000MHz |
| LQP15MN3N3B02□ | 3.3nH ±0.1nH | 500MHz | 13 | 500MHz | 190mA | 0.4Ω | 6000MHz |
| LQP15MN3N4W02□ | 3.4nH ±0.05nH | 500MHz | 13 | 500MHz | 170mA | 0.5Ω | 6000MHz |
| LQP15MN3N5W02□ | 3.5nH ±0.05nH | 500MHz | 13 | 500MHz | 170mA | 0.5Ω | 6000MHz |
| LQP15MN3N6W02□ | 3.6nH ±0.05nH | 500MHz | 13 | 500MHz | 170mA | 0.5Ω | 6000MHz |

Operating temp. range: -40 to 85°C

Only for reflow soldering

*S.R.F.: Self Resonant Frequency

Continued on the following page. ↗

Continued from the preceding page. ↘

| Part Number (□: packaging code) | Inductance | Inductance Test Frequency | Q (min.) | Q Test Frequency | Rated Current | Max. of DC Resistance | S.R.F.* (min.) |
|------------------------------------|---------------|------------------------------|----------|------------------|---------------|-----------------------|----------------|
| LQP15MN3N6B02□ | 3.6nH ±0.1nH | 500MHz | 13 | 500MHz | 170mA | 0.5Ω | 6000MHz |
| LQP15MN3N7W02□ | 3.7nH ±0.05nH | 500MHz | 13 | 500MHz | 170mA | 0.5Ω | 6000MHz |
| LQP15MN3N8W02□ | 3.8nH ±0.05nH | 500MHz | 13 | 500MHz | 170mA | 0.5Ω | 6000MHz |
| LQP15MN3N9W02□ | 3.9nH ±0.05nH | 500MHz | 13 | 500MHz | 170mA | 0.5Ω | 6000MHz |
| LQP15MN3N9B02□ | 3.9nH ±0.1nH | 500MHz | 13 | 500MHz | 170mA | 0.5Ω | 6000MHz |
| LQP15MN4N3B02□ | 4.3nH ±0.1nH | 500MHz | 13 | 500MHz | 160mA | 0.6Ω | 6000MHz |
| LQP15MN4N7B02□ | 4.7nH ±0.1nH | 500MHz | 13 | 500MHz | 160mA | 0.6Ω | 6000MHz |
| LQP15MN5N1B02□ | 5.1nH ±0.1nH | 500MHz | 13 | 500MHz | 140mA | 0.7Ω | 6000MHz |
| LQP15MN5N6B02□ | 5.6nH ±0.1nH | 500MHz | 13 | 500MHz | 140mA | 0.7Ω | 6000MHz |
| LQP15MN6N2B02□ | 6.2nH ±0.1nH | 500MHz | 13 | 500MHz | 130mA | 0.9Ω | 6000MHz |
| LQP15MN6N8B02□ | 6.8nH ±0.1nH | 500MHz | 13 | 500MHz | 130mA | 0.9Ω | 6000MHz |
| LQP15MN7N5B02□ | 7.5nH ±0.1nH | 500MHz | 13 | 500MHz | 110mA | 1.1Ω | 5500MHz |
| LQP15MN8N2B02□ | 8.2nH ±0.1nH | 500MHz | 13 | 500MHz | 110mA | 1.1Ω | 5500MHz |
| LQP15MN9N1B02□ | 9.1nH ±0.1nH | 500MHz | 13 | 500MHz | 100mA | 1.3Ω | 4500MHz |
| LQP15MN10NG02□ | 10nH ±2% | 500MHz | 13 | 500MHz | 100mA | 1.3Ω | 4500MHz |
| LQP15MN12NG02□ | 12nH ±2% | 500MHz | 13 | 500MHz | 90mA | 1.6Ω | 3700MHz |
| LQP15MN15NG02□ | 15nH ±2% | 500MHz | 13 | 500MHz | 90mA | 1.8Ω | 3300MHz |
| LQP15MN18NG02□ | 18nH ±2% | 500MHz | 13 | 500MHz | 80mA | 2.0Ω | 3100MHz |
| LQP15MN22NG02□ | 22nH ±2% | 500MHz | 13 | 500MHz | 70mA | 2.6Ω | 2800MHz |
| LQP15MN27NG02□ | 27nH ±2% | 500MHz | 13 | 500MHz | 70mA | 3.1Ω | 2500MHz |
| LQP15MN33NG02□ | 33nH ±2% | 500MHz | 13 | 500MHz | 60mA | 3.8Ω | 2100MHz |

Operating temp. range: -40 to 85°C

Only for reflow soldering

*S.R.F.: Self Resonant Frequency

Inductance-Frequency Characteristics (Typ.)



Q-Frequency Characteristics (Typ.)



LQP18MN_02 Series 0603 (1608) inch (mm)



| Packaging Code | Packaging | Minimum Quantity |
|----------------|---------------------|------------------|
| D | ø180mm Paper Taping | 4000 |
| J | ø330mm Paper Taping | 10000 |
| B | Packing in Bulk | 500 |

Continued on the following page. ↗

Continued from the preceding page. ↘

| Part Number (□: packaging code) | Inductance | Inductance Test Frequency | Q (min.) | Q Test Frequency | Rated Current | Max. of DC Resistance | S.R.F.* (min.) |
|------------------------------------|--------------|------------------------------|----------|------------------|---------------|-----------------------|----------------|
| LQP18MN1N3C02□ | 1.3nH ±0.2nH | 500MHz | 17 | 500MHz | 300mA | 0.3Ω | 6000MHz |
| LQP18MN1N5C02□ | 1.5nH ±0.2nH | 500MHz | 17 | 500MHz | 300mA | 0.3Ω | 6000MHz |
| LQP18MN1N8C02□ | 1.8nH ±0.2nH | 500MHz | 17 | 500MHz | 250mA | 0.4Ω | 6000MHz |
| LQP18MN2N2C02□ | 2.2nH ±0.2nH | 500MHz | 17 | 500MHz | 250mA | 0.4Ω | 6000MHz |
| LQP18MN2N7C02□ | 2.7nH ±0.2nH | 500MHz | 17 | 500MHz | 250mA | 0.4Ω | 6000MHz |
| LQP18MN3N3C02□ | 3.3nH ±0.2nH | 500MHz | 17 | 500MHz | 250mA | 0.4Ω | 6000MHz |
| LQP18MN3N9C02□ | 3.9nH ±0.2nH | 500MHz | 17 | 500MHz | 200mA | 0.5Ω | 5900MHz |
| LQP18MN4N7C02□ | 4.7nH ±0.2nH | 500MHz | 17 | 500MHz | 200mA | 0.5Ω | 5200MHz |
| LQP18MN5N6C02□ | 5.6nH ±0.2nH | 500MHz | 17 | 500MHz | 200mA | 0.6Ω | 4700MHz |
| LQP18MN6N8C02□ | 6.8nH ±0.2nH | 500MHz | 17 | 500MHz | 200mA | 0.7Ω | 4300MHz |
| LQP18MN8N2C02□ | 8.2nH ±0.2nH | 500MHz | 17 | 500MHz | 150mA | 0.8Ω | 3600MHz |
| LQP18MN10NG02□ | 10nH ±2% | 500MHz | 17 | 500MHz | 150mA | 1.0Ω | 3400MHz |
| LQP18MN12NG02□ | 12nH ±2% | 500MHz | 17 | 500MHz | 150mA | 1.0Ω | 3000MHz |
| LQP18MN15NG02□ | 15nH ±2% | 500MHz | 17 | 500MHz | 150mA | 1.3Ω | 2700MHz |
| LQP18MN18NG02□ | 18nH ±2% | 500MHz | 17 | 500MHz | 100mA | 1.5Ω | 2300MHz |
| LQP18MN22NG02□ | 22nH ±2% | 500MHz | 17 | 500MHz | 100mA | 1.9Ω | 2100MHz |
| LQP18MN27NG02□ | 27nH ±2% | 500MHz | 17 | 500MHz | 100mA | 2.4Ω | 1900MHz |
| LQP18MN33NG02□ | 33nH ±2% | 500MHz | 17 | 500MHz | 100mA | 2.8Ω | 1700MHz |
| LQP18MN39NG02□ | 39nH ±2% | 500MHz | 17 | 500MHz | 100mA | 2.8Ω | 1400MHz |
| LQP18MN47NG02□ | 47nH ±2% | 300MHz | 17 | 300MHz | 100mA | 2.2Ω | 1200MHz |
| LQP18MN56NG02□ | 56nH ±2% | 300MHz | 17 | 300MHz | 50mA | 3.4Ω | 1000MHz |
| LQP18MN68NG02□ | 68nH ±2% | 300MHz | 17 | 300MHz | 50mA | 3.5Ω | 900MHz |
| LQP18MN82NG02□ | 82nH ±2% | 300MHz | 17 | 300MHz | 50mA | 4.6Ω | 800MHz |
| LQP18MNR10G02□ | 100nH ±2% | 300MHz | 17 | 300MHz | 50mA | 6.1Ω | 700MHz |

Operating temp. range: -40 to 85°C

Only for reflow soldering

*S.R.F.: Self Resonant Frequency

Inductance-Frequency Characteristics (Typ.)



Q-Frequency Characteristics (Typ.)



LQW03AW_00 Series 0201 (0603) inch (mm)



| Packaging Code | Packaging | Minimum Quantity |
|----------------|---------------------|------------------|
| D | ø180mm Paper Taping | 10000 |

Continued on the following page. ↗

Continued from the preceding page. ↘

| Part Number (□: packaging code) | Inductance | Inductance Test Frequency | Q (min.) | Q Test Frequency | Rated Current | Max. of DC Resistance | S.R.F.* (min.) |
|------------------------------------|--------------|------------------------------|-----------|------------------|---------------|-----------------------|----------------|
| LQW03AW1N0C00□ | 1.0nH ±0.2nH | 250MHz | 48(Typ.) | 900MHz | 900mA | 0.03Ω | 19GHz |
| LQW03AW1N1C00□ | 1.1nH ±0.2nH | 250MHz | 41(Typ.) | 900MHz | 660mA | 0.06Ω | 19GHz |
| LQW03AW1N7C00□ | 1.7nH ±0.2nH | 250MHz | 41(Typ.) | 900MHz | 600mA | 0.07Ω | 19GHz |
| LQW03AW1N8C00□ | 1.8nH ±0.2nH | 250MHz | 37(Typ.) | 900MHz | 520mA | 0.1Ω | 19GHz |
| LQW03AW1N9C00□ | 1.9nH ±0.2nH | 250MHz | 41(Typ.) | 900MHz | 620mA | 0.08Ω | 19GHz |
| LQW03AW2N0C00□ | 2.0nH ±0.2nH | 250MHz | 42(Typ.) | 900MHz | 490mA | 0.1Ω | 19GHz |
| LQW03AW2N1C00□ | 2.1nH ±0.2nH | 250MHz | 35(Typ.) | 900MHz | 400mA | 0.16Ω | 19GHz |
| LQW03AW2N2C00□ | 2.2nH ±0.2nH | 250MHz | 33(Typ.) | 900MHz | 400mA | 0.16Ω | 19GHz |
| LQW03AW2N7C00□ | 2.7nH ±0.2nH | 250MHz | 46(Typ.) | 900MHz | 720mA | 0.06Ω | 15GHz |
| LQW03AW2N8C00□ | 2.8nH ±0.2nH | 250MHz | 44(Typ.) | 900MHz | 600mA | 0.08Ω | 14GHz |
| LQW03AW2N9C00□ | 2.9nH ±0.2nH | 250MHz | 41(Typ.) | 900MHz | 540mA | 0.1Ω | 13GHz |
| LQW03AW3N0C00□ | 3.0nH ±0.2nH | 250MHz | 34(Typ.) | 900MHz | 350mA | 0.22Ω | 14GHz |
| LQW03AW3N1C00□ | 3.1nH ±0.2nH | 250MHz | 48(Typ.) | 900MHz | 720mA | 0.07Ω | 12GHz |
| LQW03AW3N2C00□ | 3.2nH ±0.2nH | 250MHz | 48(Typ.) | 900MHz | 580mA | 0.08Ω | 10GHz |
| LQW03AW3N3C00□ | 3.3nH ±0.2nH | 250MHz | 47(Typ.) | 900MHz | 520mA | 0.11Ω | 11GHz |
| LQW03AW3N4C00□ | 3.4nH ±0.2nH | 250MHz | 43(Typ.) | 900MHz | 440mA | 0.15Ω | 11GHz |
| LQW03AW3N5C00□ | 3.5nH ±0.2nH | 250MHz | 43(Typ.) | 900MHz | 440mA | 0.15Ω | 12GHz |
| LQW03AW3N6C00□ | 3.6nH ±0.2nH | 250MHz | 36(Typ.) | 900MHz | 340mA | 0.23Ω | 11GHz |
| LQW03AW3N7C00□ | 3.7nH ±0.2nH | 250MHz | 38(Typ.) | 900MHz | 340mA | 0.23Ω | 11GHz |
| LQW03AW3N9C00□ | 3.9nH ±0.2nH | 250MHz | 48(Typ.) | 900MHz | 650mA | 0.07Ω | 11GHz |
| LQW03AW4N3J00□ | 4.3nH ±5% | 100MHz | 45(Typ.) | 900MHz | 480mA | 0.12Ω | 11GHz |
| LQW03AW4N7J00□ | 4.7nH ±5% | 100MHz | 45(Typ.) | 900MHz | 620mA | 0.09Ω | 9.5GHz |
| LQW03AW5N1J00□ | 5.1nH ±5% | 100MHz | 45(Typ.) | 900MHz | 480mA | 0.14Ω | 9.5GHz |
| LQW03AW5N4J00□ | 5.4nH ±5% | 100MHz | 46 (Typ.) | 900MHz | 420mA | 0.21Ω | 9.5GHz |
| LQW03AW5N6J00□ | 5.6nH ±5% | 100MHz | 37 (Typ.) | 900MHz | 330mA | 0.33Ω | 8.3GHz |
| LQW03AW5N8J00□ | 5.8nH ±5% | 100MHz | 47 (Typ.) | 900MHz | 460mA | 0.16Ω | 8.8GHz |
| LQW03AW6N2J00□ | 6.2nH ±5% | 100MHz | 39(Typ.) | 900MHz | 360mA | 0.22Ω | 9.9GHz |
| LQW03AW6N8J00□ | 6.8nH ±5% | 100MHz | 42 (Typ.) | 900MHz | 460mA | 0.18Ω | 7.7GHz |
| LQW03AW7N5J00□ | 7.5nH ±5% | 100MHz | 41 (Typ.) | 900MHz | 400mA | 0.24Ω | 7.5GHz |
| LQW03AW8N2J00□ | 8.2nH ±5% | 100MHz | 40(Typ.) | 900MHz | 290mA | 0.26Ω | 8.5GHz |
| LQW03AW8N7J00□ | 8.7nH ±5% | 100MHz | 39 (Typ.) | 900MHz | 290mA | 0.42Ω | 7.5GHz |
| LQW03AW9N1J00□ | 9.1nH ±5% | 100MHz | 46 (Typ.) | 900MHz | 460mA | 0.22Ω | 6.4GHz |
| LQW03AW10NJ00□ | 10nH ±5% | 100MHz | 37(Typ.) | 900MHz | 250mA | 0.46Ω | 7.2GHz |
| LQW03AW11NJ00□ | 11nH ±5% | 100MHz | 37(Typ.) | 900MHz | 260mA | 0.47Ω | 7GHz |
| LQW03AW12NJ00□ | 12.5nH ±5% | 100MHz | 39(Typ.) | 900MHz | 280mA | 0.54Ω | 6GHz |
| LQW03AW13NJ00□ | 13nH ±5% | 100MHz | 39 (Typ.) | 900MHz | 280mA | 0.54Ω | 5.9GHz |
| LQW03AW14NJ00□ | 13.5nH ±5% | 100MHz | 37(Typ.) | 900MHz | 240mA | 0.53Ω | 6GHz |
| LQW03AW15NJ00□ | 15.5nH ±5% | 100MHz | 38(Typ.) | 900MHz | 230mA | 0.6Ω | 5.7GHz |

Operating temp. range (Self-temp. rise included): -55 to 125°C

Only for reflow soldering

*S.R.F.: Self Resonant Frequency

Inductance-Frequency Characteristics (Typ.)



Q-Frequency Characteristics (Typ.)



LQW04AN_00 Series 03015 (0804) inch (mm)



(in mm)

| Packaging Code | Packaging | Minimum Quantity |
|----------------|---------------------|------------------|
| D | ø180mm Paper Taping | 10000 |
| B | Packing in Bulk | 500 |

| Part Number (□: packaging code) | Inductance | Inductance Test Frequency | Q (min.) | Q Test Frequency | Rated Current | Max. of DC Resistance | S.R.F.* (min.) |
|------------------------------------|--------------|------------------------------|----------|------------------|---------------|-----------------------|----------------|
| LQW04AN0N8C00□ | 0.8nH ±0.2nH | 100MHz | 23 | 250MHz | 1800mA | 0.02Ω | 20.0GHz |
| LQW04AN0N8D00□ | 0.8nH ±0.5nH | 100MHz | 23 | 250MHz | 1800mA | 0.02Ω | 20.0GHz |
| LQW04AN1N1C00□ | 1.1nH ±0.2nH | 100MHz | 15 | 250MHz | 990mA | 0.03Ω | 20.0GHz |
| LQW04AN1N1D00□ | 1.1nH ±0.5nH | 100MHz | 15 | 250MHz | 990mA | 0.03Ω | 20.0GHz |
| LQW04AN1N3C00□ | 1.3nH ±0.2nH | 100MHz | 15 | 250MHz | 1500mA | 0.03Ω | 20.0GHz |
| LQW04AN1N3D00□ | 1.3nH ±0.5nH | 100MHz | 15 | 250MHz | 1500mA | 0.03Ω | 20.0GHz |
| LQW04AN1N4C00□ | 1.4nH ±0.2nH | 100MHz | 15 | 250MHz | 1200mA | 0.03Ω | 20.0GHz |
| LQW04AN1N4D00□ | 1.4nH ±0.5nH | 100MHz | 15 | 250MHz | 1200mA | 0.03Ω | 20.0GHz |
| LQW04AN1N5C00□ | 1.5nH ±0.2nH | 100MHz | 18 | 250MHz | 940mA | 0.05Ω | 20.0GHz |
| LQW04AN1N5D00□ | 1.5nH ±0.5nH | 100MHz | 18 | 250MHz | 940mA | 0.05Ω | 20.0GHz |
| LQW04AN1N6C00□ | 1.6nH ±0.2nH | 100MHz | 15 | 250MHz | 700mA | 0.06Ω | 17.0GHz |
| LQW04AN1N6D00□ | 1.6nH ±0.5nH | 100MHz | 15 | 250MHz | 700mA | 0.06Ω | 17.0GHz |
| LQW04AN1N7C00□ | 1.7nH ±0.2nH | 100MHz | 15 | 250MHz | 700mA | 0.06Ω | 17.0GHz |
| LQW04AN1N7D00□ | 1.7nH ±0.5nH | 100MHz | 15 | 250MHz | 700mA | 0.06Ω | 17.0GHz |
| LQW04AN1N8C00□ | 1.8nH ±0.2nH | 100MHz | 15 | 250MHz | 700mA | 0.06Ω | 17.0GHz |
| LQW04AN1N8D00□ | 1.8nH ±0.5nH | 100MHz | 15 | 250MHz | 700mA | 0.06Ω | 17.0GHz |
| LQW04AN1N9C00□ | 1.9nH ±0.2nH | 100MHz | 10 | 250MHz | 490mA | 0.12Ω | 15.0GHz |
| LQW04AN1N9D00□ | 1.9nH ±0.5nH | 100MHz | 10 | 250MHz | 490mA | 0.12Ω | 15.0GHz |
| LQW04AN2N0C00□ | 2.0nH ±0.2nH | 100MHz | 21 | 250MHz | 1100mA | 0.03Ω | 20.0GHz |
| LQW04AN2N0D00□ | 2.0nH ±0.5nH | 100MHz | 21 | 250MHz | 1100mA | 0.03Ω | 20.0GHz |
| LQW04AN2N1C00□ | 2.1nH ±0.2nH | 100MHz | 14 | 250MHz | 1100mA | 0.03Ω | 12.0GHz |
| LQW04AN2N1D00□ | 2.1nH ±0.5nH | 100MHz | 14 | 250MHz | 1100mA | 0.03Ω | 12.0GHz |
| LQW04AN2N2C00□ | 2.2nH ±0.2nH | 100MHz | 21 | 250MHz | 1100mA | 0.04Ω | 12.0GHz |
| LQW04AN2N2D00□ | 2.2nH ±0.5nH | 100MHz | 21 | 250MHz | 1100mA | 0.04Ω | 12.0GHz |
| LQW04AN2N3C00□ | 2.3nH ±0.2nH | 100MHz | 18 | 250MHz | 780mA | 0.07Ω | 20.0GHz |
| LQW04AN2N3D00□ | 2.3nH ±0.5nH | 100MHz | 18 | 250MHz | 780mA | 0.07Ω | 20.0GHz |
| LQW04AN2N4C00□ | 2.4nH ±0.2nH | 100MHz | 15 | 250MHz | 570mA | 0.07Ω | 15.0GHz |
| LQW04AN2N4D00□ | 2.4nH ±0.5nH | 100MHz | 15 | 250MHz | 570mA | 0.07Ω | 15.0GHz |
| LQW04AN2N5C00□ | 2.5nH ±0.2nH | 100MHz | 10 | 250MHz | 490mA | 0.12Ω | 10.0GHz |
| LQW04AN2N5D00□ | 2.5nH ±0.5nH | 100MHz | 10 | 250MHz | 490mA | 0.12Ω | 10.0GHz |
| LQW04AN2N6C00□ | 2.6nH ±0.2nH | 100MHz | 15 | 250MHz | 620mA | 0.07Ω | 15.0GHz |
| LQW04AN2N6D00□ | 2.6nH ±0.5nH | 100MHz | 15 | 250MHz | 620mA | 0.07Ω | 15.0GHz |
| LQW04AN2N7C00□ | 2.7nH ±0.2nH | 100MHz | 15 | 250MHz | 570mA | 0.07Ω | 15.0GHz |
| LQW04AN2N7D00□ | 2.7nH ±0.5nH | 100MHz | 15 | 250MHz | 570mA | 0.07Ω | 15.0GHz |
| LQW04AN2N8C00□ | 2.8nH ±0.2nH | 100MHz | 15 | 250MHz | 620mA | 0.07Ω | 15.0GHz |
| LQW04AN2N8D00□ | 2.8nH ±0.5nH | 100MHz | 15 | 250MHz | 620mA | 0.07Ω | 15.0GHz |
| LQW04AN2N9C00□ | 2.9nH ±0.2nH | 100MHz | 10 | 250MHz | 490mA | 0.12Ω | 13.0GHz |
| LQW04AN2N9D00□ | 2.9nH ±0.5nH | 100MHz | 10 | 250MHz | 490mA | 0.12Ω | 13.0GHz |
| LQW04AN3N0C00□ | 3.0nH ±0.2nH | 100MHz | 15 | 250MHz | 620mA | 0.07Ω | 13.0GHz |
| LQW04AN3N0D00□ | 3.0nH ±0.5nH | 100MHz | 15 | 250MHz | 620mA | 0.07Ω | 13.0GHz |

Operating temp. range: -55 to 125°C

Only for reflow soldering

*S.R.F.: Self Resonant Frequency

Continued on the following page. ↗

Continued from the preceding page. ↘

| Part Number (□: packaging code) | Inductance | Inductance Test Frequency | Q (min.) | Q Test Frequency | Rated Current | Max. of DC Resistance | S.R.F.* (min.) |
|------------------------------------|--------------|------------------------------|----------|------------------|---------------|-----------------------|----------------|
| LQW04AN3N1C00□ | 3.1nH ±0.2nH | 100MHz | 10 | 250MHz | 490mA | 0.12Ω | 10.0GHz |
| LQW04AN3N1D00□ | 3.1nH ±0.5nH | 100MHz | 10 | 250MHz | 490mA | 0.12Ω | 10.0GHz |
| LQW04AN3N2C00□ | 3.2nH ±0.2nH | 100MHz | 10 | 250MHz | 400mA | 0.17Ω | 9.0GHz |
| LQW04AN3N2D00□ | 3.2nH ±0.5nH | 100MHz | 10 | 250MHz | 400mA | 0.17Ω | 9.0GHz |
| LQW04AN3N3C00□ | 3.3nH ±0.2nH | 100MHz | 10 | 250MHz | 440mA | 0.14Ω | 10.0GHz |
| LQW04AN3N3D00□ | 3.3nH ±0.5nH | 100MHz | 10 | 250MHz | 440mA | 0.14Ω | 10.0GHz |
| LQW04AN3N4C00□ | 3.4nH ±0.2nH | 100MHz | 10 | 250MHz | 310mA | 0.27Ω | 8.0GHz |
| LQW04AN3N4D00□ | 3.4nH ±0.5nH | 100MHz | 10 | 250MHz | 310mA | 0.27Ω | 8.0GHz |
| LQW04AN3N6C00□ | 3.6nH ±0.2nH | 100MHz | 15 | 250MHz | 530mA | 0.10Ω | 13.0GHz |
| LQW04AN3N6D00□ | 3.6nH ±0.5nH | 100MHz | 15 | 250MHz | 530mA | 0.10Ω | 13.0GHz |
| LQW04AN3N7C00□ | 3.7nH ±0.2nH | 100MHz | 20 | 250MHz | 440mA | 0.14Ω | 10.0GHz |
| LQW04AN3N7D00□ | 3.7nH ±0.5nH | 100MHz | 20 | 250MHz | 440mA | 0.14Ω | 10.0GHz |
| LQW04AN3N8C00□ | 3.8nH ±0.2nH | 100MHz | 15 | 250MHz | 530mA | 0.10Ω | 11.0GHz |
| LQW04AN3N8D00□ | 3.8nH ±0.5nH | 100MHz | 15 | 250MHz | 530mA | 0.10Ω | 11.0GHz |
| LQW04AN3N9C00□ | 3.9nH ±0.2nH | 100MHz | 15 | 250MHz | 530mA | 0.10Ω | 12.0GHz |
| LQW04AN3N9D00□ | 3.9nH ±0.5nH | 100MHz | 15 | 250MHz | 530mA | 0.10Ω | 12.0GHz |
| LQW04AN4N0C00□ | 4nH ±0.2nH | 100MHz | 15 | 250MHz | 530mA | 0.10Ω | 11.0GHz |
| LQW04AN4N0D00□ | 4nH ±0.5nH | 100MHz | 15 | 250MHz | 530mA | 0.10Ω | 11.0GHz |
| LQW04AN4N1C00□ | 4.1nH ±0.2nH | 100MHz | 15 | 250MHz | 530mA | 0.10Ω | 11.0GHz |
| LQW04AN4N1D00□ | 4.1nH ±0.5nH | 100MHz | 15 | 250MHz | 530mA | 0.10Ω | 11.0GHz |
| LQW04AN4N2C00□ | 4.2nH ±0.2nH | 100MHz | 15 | 250MHz | 530mA | 0.10Ω | 11.0GHz |
| LQW04AN4N2D00□ | 4.2nH ±0.5nH | 100MHz | 15 | 250MHz | 530mA | 0.10Ω | 11.0GHz |
| LQW04AN4N3C00□ | 4.3nH ±0.2nH | 100MHz | 15 | 250MHz | 530mA | 0.10Ω | 11.0GHz |
| LQW04AN4N3D00□ | 4.3nH ±0.5nH | 100MHz | 15 | 250MHz | 530mA | 0.10Ω | 11.0GHz |
| LQW04AN4N4C00□ | 4.4nH ±0.2nH | 100MHz | 20 | 250MHz | 440mA | 0.14Ω | 10.0GHz |
| LQW04AN4N4D00□ | 4.4nH ±0.5nH | 100MHz | 20 | 250MHz | 440mA | 0.14Ω | 10.0GHz |
| LQW04AN4N5C00□ | 4.5nH ±0.2nH | 100MHz | 20 | 250MHz | 440mA | 0.14Ω | 10.0GHz |
| LQW04AN4N5D00□ | 4.5nH ±0.5nH | 100MHz | 20 | 250MHz | 440mA | 0.14Ω | 10.0GHz |
| LQW04AN4N6C00□ | 4.6nH ±0.2nH | 100MHz | 20 | 250MHz | 440mA | 0.14Ω | 10.0GHz |
| LQW04AN4N6D00□ | 4.6nH ±0.5nH | 100MHz | 20 | 250MHz | 440mA | 0.14Ω | 10.0GHz |
| LQW04AN4N7C00□ | 4.7nH ±0.2nH | 100MHz | 20 | 250MHz | 440mA | 0.14Ω | 10.0GHz |
| LQW04AN4N7D00□ | 4.7nH ±0.5nH | 100MHz | 20 | 250MHz | 440mA | 0.14Ω | 10.0GHz |
| LQW04AN4N8C00□ | 4.8nH ±0.2nH | 100MHz | 15 | 250MHz | 350mA | 0.23Ω | 9.0GHz |
| LQW04AN4N8D00□ | 4.8nH ±0.5nH | 100MHz | 15 | 250MHz | 350mA | 0.23Ω | 9.0GHz |
| LQW04AN4N9C00□ | 4.9nH ±0.2nH | 100MHz | 15 | 250MHz | 350mA | 0.23Ω | 9.0GHz |
| LQW04AN4N9D00□ | 4.9nH ±0.5nH | 100MHz | 15 | 250MHz | 350mA | 0.23Ω | 9.0GHz |
| LQW04AN5N0C00□ | 5nH ±0.2nH | 100MHz | 15 | 250MHz | 350mA | 0.23Ω | 9.0GHz |
| LQW04AN5N0D00□ | 5nH ±0.5nH | 100MHz | 15 | 250MHz | 350mA | 0.23Ω | 9.0GHz |
| LQW04AN5N1C00□ | 5.1nH ±0.2nH | 100MHz | 20 | 250MHz | 470mA | 0.12Ω | 10.0GHz |
| LQW04AN5N1D00□ | 5.1nH ±0.5nH | 100MHz | 20 | 250MHz | 470mA | 0.12Ω | 10.0GHz |
| LQW04AN5N2C00□ | 5.2nH ±0.2nH | 100MHz | 20 | 250MHz | 390mA | 0.19Ω | 9.0GHz |
| LQW04AN5N2D00□ | 5.2nH ±0.5nH | 100MHz | 20 | 250MHz | 390mA | 0.19Ω | 9.0GHz |
| LQW04AN5N3C00□ | 5.3nH ±0.2nH | 100MHz | 20 | 250MHz | 390mA | 0.19Ω | 9.0GHz |
| LQW04AN5N3D00□ | 5.3nH ±0.5nH | 100MHz | 20 | 250MHz | 390mA | 0.19Ω | 9.0GHz |
| LQW04AN5N4C00□ | 5.4nH ±0.2nH | 100MHz | 20 | 250MHz | 390mA | 0.19Ω | 9.0GHz |
| LQW04AN5N4D00□ | 5.4nH ±0.5nH | 100MHz | 20 | 250MHz | 390mA | 0.19Ω | 9.0GHz |
| LQW04AN5N5C00□ | 5.5nH ±0.2nH | 100MHz | 20 | 250MHz | 470mA | 0.12Ω | 9.0GHz |
| LQW04AN5N5D00□ | 5.5nH ±0.5nH | 100MHz | 20 | 250MHz | 470mA | 0.12Ω | 9.0GHz |
| LQW04AN5N6C00□ | 5.6nH ±0.2nH | 100MHz | 20 | 250MHz | 470mA | 0.12Ω | 9.0GHz |
| LQW04AN5N6D00□ | 5.6nH ±0.5nH | 100MHz | 20 | 250MHz | 470mA | 0.12Ω | 9.0GHz |
| LQW04AN5N7C00□ | 5.7nH ±0.2nH | 100MHz | 20 | 250MHz | 390mA | 0.19Ω | 9.0GHz |
| LQW04AN5N7D00□ | 5.7nH ±0.5nH | 100MHz | 20 | 250MHz | 390mA | 0.19Ω | 9.0GHz |
| LQW04AN5N8C00□ | 5.8nH ±0.2nH | 100MHz | 20 | 250MHz | 390mA | 0.19Ω | 9.0GHz |

Operating temp. range: -55 to 125°C

Only for reflow soldering

*S.R.F.: Self Resonant Frequency

Continued on the following page. ↗

Continued from the preceding page. ↘

| Part Number (□: packaging code) | Inductance | Inductance Test Frequency | Q (min.) | Q Test Frequency | Rated Current | Max. of DC Resistance | S.R.F.* (min.) |
|------------------------------------|--------------|------------------------------|----------|------------------|---------------|-----------------------|----------------|
| LQW04AN5N8D00□ | 5.8nH ±0.5nH | 100MHz | 20 | 250MHz | 390mA | 0.19Ω | 9.0GHz |
| LQW04AN5N9C00□ | 5.9nH ±0.2nH | 100MHz | 20 | 250MHz | 390mA | 0.19Ω | 9.0GHz |
| LQW04AN5N9D00□ | 5.9nH ±0.5nH | 100MHz | 20 | 250MHz | 390mA | 0.19Ω | 9.0GHz |
| LQW04AN6N0C00□ | 6nH ±0.2nH | 100MHz | 20 | 250MHz | 390mA | 0.19Ω | 9.0GHz |
| LQW04AN6N0D00□ | 6nH ±0.5nH | 100MHz | 20 | 250MHz | 390mA | 0.19Ω | 9.0GHz |
| LQW04AN6N1C00□ | 6.1nH ±0.2nH | 100MHz | 20 | 250MHz | 390mA | 0.19Ω | 9.0GHz |
| LQW04AN6N1D00□ | 6.1nH ±0.5nH | 100MHz | 20 | 250MHz | 390mA | 0.19Ω | 9.0GHz |
| LQW04AN6N2C00□ | 6.2nH ±0.2nH | 100MHz | 20 | 250MHz | 390mA | 0.19Ω | 9.0GHz |
| LQW04AN6N2D00□ | 6.2nH ±0.5nH | 100MHz | 20 | 250MHz | 390mA | 0.19Ω | 9.0GHz |
| LQW04AN6N3C00□ | 6.3nH ±0.2nH | 100MHz | 20 | 250MHz | 390mA | 0.19Ω | 9.0GHz |
| LQW04AN6N3D00□ | 6.3nH ±0.5nH | 100MHz | 20 | 250MHz | 390mA | 0.19Ω | 9.0GHz |
| LQW04AN6N4C00□ | 6.4nH ±0.2nH | 100MHz | 20 | 250MHz | 390mA | 0.19Ω | 9.0GHz |
| LQW04AN6N4D00□ | 6.4nH ±0.5nH | 100MHz | 20 | 250MHz | 390mA | 0.19Ω | 9.0GHz |
| LQW04AN6N5C00□ | 6.5nH ±0.2nH | 100MHz | 20 | 250MHz | 390mA | 0.19Ω | 9.0GHz |
| LQW04AN6N5D00□ | 6.5nH ±0.5nH | 100MHz | 20 | 250MHz | 390mA | 0.19Ω | 9.0GHz |
| LQW04AN6N6C00□ | 6.6nH ±0.2nH | 100MHz | 20 | 250MHz | 390mA | 0.19Ω | 9.0GHz |
| LQW04AN6N6D00□ | 6.6nH ±0.5nH | 100MHz | 20 | 250MHz | 390mA | 0.19Ω | 9.0GHz |
| LQW04AN6N7C00□ | 6.7nH ±0.2nH | 100MHz | 20 | 250MHz | 390mA | 0.19Ω | 9.0GHz |
| LQW04AN6N7D00□ | 6.7nH ±0.5nH | 100MHz | 20 | 250MHz | 390mA | 0.19Ω | 9.0GHz |
| LQW04AN6N8C00□ | 6.8nH ±0.2nH | 100MHz | 20 | 250MHz | 440mA | 0.14Ω | 9.0GHz |
| LQW04AN6N8D00□ | 6.8nH ±0.5nH | 100MHz | 20 | 250MHz | 440mA | 0.14Ω | 9.0GHz |
| LQW04AN6N9C00□ | 6.9nH ±0.2nH | 100MHz | 20 | 250MHz | 440mA | 0.14Ω | 8.0GHz |
| LQW04AN6N9D00□ | 6.9nH ±0.5nH | 100MHz | 20 | 250MHz | 440mA | 0.14Ω | 8.0GHz |
| LQW04AN7N0C00□ | 7nH ±0.2nH | 100MHz | 20 | 250MHz | 440mA | 0.14Ω | 8.0GHz |
| LQW04AN7N0D00□ | 7nH ±0.5nH | 100MHz | 20 | 250MHz | 440mA | 0.14Ω | 8.0GHz |
| LQW04AN7N1C00□ | 7.1nH ±0.2nH | 100MHz | 20 | 250MHz | 440mA | 0.14Ω | 8.0GHz |
| LQW04AN7N1D00□ | 7.1nH ±0.5nH | 100MHz | 20 | 250MHz | 440mA | 0.14Ω | 8.0GHz |
| LQW04AN7N2C00□ | 7.2nH ±0.2nH | 100MHz | 20 | 250MHz | 440mA | 0.14Ω | 8.0GHz |
| LQW04AN7N2D00□ | 7.2nH ±0.5nH | 100MHz | 20 | 250MHz | 440mA | 0.14Ω | 8.0GHz |
| LQW04AN7N3C00□ | 7.3nH ±0.2nH | 100MHz | 20 | 250MHz | 440mA | 0.14Ω | 8.0GHz |
| LQW04AN7N3D00□ | 7.3nH ±0.5nH | 100MHz | 20 | 250MHz | 440mA | 0.14Ω | 8.0GHz |
| LQW04AN7N4C00□ | 7.4nH ±0.2nH | 100MHz | 20 | 250MHz | 440mA | 0.14Ω | 8.0GHz |
| LQW04AN7N4D00□ | 7.4nH ±0.5nH | 100MHz | 20 | 250MHz | 440mA | 0.14Ω | 8.0GHz |
| LQW04AN7N5C00□ | 7.5nH ±0.2nH | 100MHz | 20 | 250MHz | 440mA | 0.14Ω | 8.0GHz |
| LQW04AN7N5D00□ | 7.5nH ±0.5nH | 100MHz | 20 | 250MHz | 440mA | 0.14Ω | 8.0GHz |
| LQW04AN7N6C00□ | 7.6nH ±0.2nH | 100MHz | 20 | 250MHz | 350mA | 0.23Ω | 8.0GHz |
| LQW04AN7N6D00□ | 7.6nH ±0.5nH | 100MHz | 20 | 250MHz | 350mA | 0.23Ω | 8.0GHz |
| LQW04AN7N7C00□ | 7.7nH ±0.2nH | 100MHz | 20 | 250MHz | 350mA | 0.23Ω | 8.0GHz |
| LQW04AN7N7D00□ | 7.7nH ±0.5nH | 100MHz | 20 | 250MHz | 350mA | 0.23Ω | 8.0GHz |
| LQW04AN7N8C00□ | 7.8nH ±0.2nH | 100MHz | 20 | 250MHz | 350mA | 0.23Ω | 8.0GHz |
| LQW04AN7N8D00□ | 7.8nH ±0.5nH | 100MHz | 20 | 250MHz | 350mA | 0.23Ω | 8.0GHz |
| LQW04AN7N9C00□ | 7.9nH ±0.2nH | 100MHz | 20 | 250MHz | 350mA | 0.23Ω | 8.0GHz |
| LQW04AN7N9D00□ | 7.9nH ±0.5nH | 100MHz | 20 | 250MHz | 350mA | 0.23Ω | 8.0GHz |
| LQW04AN8N0C00□ | 8nH ±0.2nH | 100MHz | 20 | 250MHz | 350mA | 0.23Ω | 8.0GHz |
| LQW04AN8N0D00□ | 8nH ±0.5nH | 100MHz | 20 | 250MHz | 350mA | 0.23Ω | 8.0GHz |
| LQW04AN8N1C00□ | 8.1nH ±0.2nH | 100MHz | 20 | 250MHz | 350mA | 0.23Ω | 8.0GHz |
| LQW04AN8N1D00□ | 8.1nH ±0.5nH | 100MHz | 20 | 250MHz | 350mA | 0.23Ω | 8.0GHz |
| LQW04AN8N2C00□ | 8.2nH ±0.2nH | 100MHz | 20 | 250MHz | 350mA | 0.23Ω | 8.0GHz |
| LQW04AN8N2D00□ | 8.2nH ±0.5nH | 100MHz | 20 | 250MHz | 350mA | 0.23Ω | 8.0GHz |
| LQW04AN8N3C00□ | 8.3nH ±0.2nH | 100MHz | 20 | 250MHz | 350mA | 0.23Ω | 8.0GHz |
| LQW04AN8N3D00□ | 8.3nH ±0.5nH | 100MHz | 20 | 250MHz | 350mA | 0.23Ω | 8.0GHz |
| LQW04AN8N4C00□ | 8.4nH ±0.2nH | 100MHz | 20 | 250MHz | 350mA | 0.23Ω | 8.0GHz |
| LQW04AN8N4D00□ | 8.4nH ±0.5nH | 100MHz | 20 | 250MHz | 350mA | 0.23Ω | 8.0GHz |

Operating temp. range: -55 to 125°C
 Only for reflow soldering
 *S.R.F.: Self Resonant Frequency

Continued on the following page. ↗

Continued from the preceding page. ↘

| Part Number (□: packaging code) | Inductance | Inductance Test Frequency | Q (min.) | Q Test Frequency | Rated Current | Max. of DC Resistance | S.R.F.* (min.) |
|------------------------------------|--------------|------------------------------|----------|------------------|---------------|-----------------------|----------------|
| LQW04AN8N5C00□ | 8.5nH ±0.2nH | 100MHz | 15 | 250MHz | 290mA | 0.33Ω | 7.0GHz |
| LQW04AN8N5D00□ | 8.5nH ±0.5nH | 100MHz | 15 | 250MHz | 290mA | 0.33Ω | 7.0GHz |
| LQW04AN8N6C00□ | 8.6nH ±0.2nH | 100MHz | 15 | 250MHz | 290mA | 0.33Ω | 7.0GHz |
| LQW04AN8N6D00□ | 8.6nH ±0.5nH | 100MHz | 15 | 250MHz | 290mA | 0.33Ω | 7.0GHz |
| LQW04AN8N7C00□ | 8.7nH ±0.2nH | 100MHz | 15 | 250MHz | 290mA | 0.33Ω | 7.0GHz |
| LQW04AN8N7D00□ | 8.7nH ±0.5nH | 100MHz | 15 | 250MHz | 290mA | 0.33Ω | 7.0GHz |
| LQW04AN8N8C00□ | 8.8nH ±0.2nH | 100MHz | 15 | 250MHz | 290mA | 0.33Ω | 7.0GHz |
| LQW04AN8N8D00□ | 8.8nH ±0.5nH | 100MHz | 15 | 250MHz | 290mA | 0.33Ω | 7.0GHz |
| LQW04AN8N9C00□ | 8.9nH ±0.2nH | 100MHz | 20 | 250MHz | 330mA | 0.26Ω | 7.0GHz |
| LQW04AN8N9D00□ | 8.9nH ±0.5nH | 100MHz | 20 | 250MHz | 330mA | 0.26Ω | 7.0GHz |
| LQW04AN9N0C00□ | 9nH ±0.2nH | 100MHz | 20 | 250MHz | 330mA | 0.26Ω | 7.0GHz |
| LQW04AN9N0D00□ | 9nH ±0.5nH | 100MHz | 20 | 250MHz | 330mA | 0.26Ω | 7.0GHz |
| LQW04AN9N1C00□ | 9.1nH ±0.2nH | 100MHz | 20 | 250MHz | 400mA | 0.16Ω | 7.0GHz |
| LQW04AN9N1D00□ | 9.1nH ±0.5nH | 100MHz | 20 | 250MHz | 400mA | 0.16Ω | 7.0GHz |
| LQW04AN9N2C00□ | 9.2nH ±0.2nH | 100MHz | 20 | 250MHz | 400mA | 0.16Ω | 7.0GHz |
| LQW04AN9N2D00□ | 9.2nH ±0.5nH | 100MHz | 20 | 250MHz | 400mA | 0.16Ω | 7.0GHz |
| LQW04AN9N3C00□ | 9.3nH ±0.2nH | 100MHz | 20 | 250MHz | 330mA | 0.26Ω | 7.0GHz |
| LQW04AN9N3D00□ | 9.3nH ±0.5nH | 100MHz | 20 | 250MHz | 330mA | 0.26Ω | 7.0GHz |
| LQW04AN9N4C00□ | 9.4nH ±0.2nH | 100MHz | 20 | 250MHz | 330mA | 0.26Ω | 7.0GHz |
| LQW04AN9N4D00□ | 9.4nH ±0.5nH | 100MHz | 20 | 250MHz | 330mA | 0.26Ω | 7.0GHz |
| LQW04AN9N5C00□ | 9.5nH ±0.2nH | 100MHz | 20 | 250MHz | 330mA | 0.26Ω | 7.0GHz |
| LQW04AN9N5D00□ | 9.5nH ±0.5nH | 100MHz | 20 | 250MHz | 330mA | 0.26Ω | 7.0GHz |
| LQW04AN9N6C00□ | 9.6nH ±0.2nH | 100MHz | 20 | 250MHz | 330mA | 0.26Ω | 7.0GHz |
| LQW04AN9N6D00□ | 9.6nH ±0.5nH | 100MHz | 20 | 250MHz | 330mA | 0.26Ω | 7.0GHz |
| LQW04AN9N7C00□ | 9.7nH ±0.2nH | 100MHz | 20 | 250MHz | 330mA | 0.26Ω | 7.0GHz |
| LQW04AN9N7D00□ | 9.7nH ±0.5nH | 100MHz | 20 | 250MHz | 330mA | 0.26Ω | 7.0GHz |
| LQW04AN9N8C00□ | 9.8nH ±0.2nH | 100MHz | 20 | 250MHz | 330mA | 0.26Ω | 7.0GHz |
| LQW04AN9N8D00□ | 9.8nH ±0.5nH | 100MHz | 20 | 250MHz | 330mA | 0.26Ω | 7.0GHz |
| LQW04AN9N9C00□ | 9.9nH ±0.2nH | 100MHz | 20 | 250MHz | 330mA | 0.26Ω | 7.0GHz |
| LQW04AN9N9D00□ | 9.9nH ±0.5nH | 100MHz | 20 | 250MHz | 330mA | 0.26Ω | 7.0GHz |
| LQW04AN10NH00□ | 10nH ±3% | 100MHz | 20 | 250MHz | 330mA | 0.26Ω | 7.0GHz |
| LQW04AN10NJ00□ | 10nH ±5% | 100MHz | 20 | 250MHz | 330mA | 0.26Ω | 7.0GHz |
| LQW04AN11NH00□ | 11nH ±3% | 100MHz | 15 | 250MHz | 310mA | 0.28Ω | 7.0GHz |
| LQW04AN11NJ00□ | 11nH ±5% | 100MHz | 15 | 250MHz | 310mA | 0.28Ω | 7.0GHz |
| LQW04AN12NH00□ | 12nH ±3% | 100MHz | 15 | 250MHz | 310mA | 0.28Ω | 6.0GHz |
| LQW04AN12NJ00□ | 12nH ±5% | 100MHz | 15 | 250MHz | 310mA | 0.28Ω | 6.0GHz |
| LQW04AN13NH00□ | 13nH ±3% | 100MHz | 15 | 250MHz | 280mA | 0.34Ω | 6.0GHz |
| LQW04AN13NJ00□ | 13nH ±5% | 100MHz | 15 | 250MHz | 280mA | 0.34Ω | 6.0GHz |
| LQW04AN14NH00□ | 14nH ±3% | 100MHz | 15 | 250MHz | 280mA | 0.34Ω | 6.0GHz |
| LQW04AN14NJ00□ | 14nH ±5% | 100MHz | 15 | 250MHz | 280mA | 0.34Ω | 6.0GHz |
| LQW04AN15NH00□ | 15nH ±3% | 100MHz | 15 | 250MHz | 240mA | 0.48Ω | 5.5GHz |
| LQW04AN15NJ00□ | 15nH ±5% | 100MHz | 15 | 250MHz | 240mA | 0.48Ω | 5.5GHz |
| LQW04AN16NH00□ | 16nH ±3% | 100MHz | 15 | 250MHz | 270mA | 0.38Ω | 5.5GHz |
| LQW04AN16NJ00□ | 16nH ±5% | 100MHz | 15 | 250MHz | 270mA | 0.38Ω | 5.5GHz |
| LQW04AN18NH00□ | 18nH ±3% | 100MHz | 15 | 250MHz | 220mA | 0.54Ω | 5.0GHz |
| LQW04AN18NJ00□ | 18nH ±5% | 100MHz | 15 | 250MHz | 220mA | 0.54Ω | 5.0GHz |
| LQW04AN19NH00□ | 19nH ±3% | 100MHz | 15 | 250MHz | 160mA | 0.73Ω | 5.0GHz |
| LQW04AN19NJ00□ | 19nH ±5% | 100MHz | 15 | 250MHz | 160mA | 0.73Ω | 5.0GHz |
| LQW04AN20NH00□ | 20nH ±3% | 100MHz | 15 | 250MHz | 210mA | 0.56Ω | 5.0GHz |
| LQW04AN20NJ00□ | 20nH ±5% | 100MHz | 15 | 250MHz | 210mA | 0.56Ω | 5.0GHz |
| LQW04AN22NH00□ | 22nH ±3% | 100MHz | 15 | 250MHz | 200mA | 0.63Ω | 5.0GHz |
| LQW04AN22NJ00□ | 22nH ±5% | 100MHz | 15 | 250MHz | 200mA | 0.63Ω | 5.0GHz |
| LQW04AN23NH00□ | 23nH ±3% | 100MHz | 15 | 250MHz | 160mA | 0.95Ω | 4.0GHz |

Operating temp. range: -55 to 125°C

Only for reflow soldering

*S.R.F.: Self Resonant Frequency

Continued on the following page. ↗

Continued from the preceding page. ↘

| Part Number (□: packaging code) | Inductance | Inductance Test Frequency | Q (min.) | Q Test Frequency | Rated Current | Max. of DC Resistance | S.R.F.* (min.) |
|------------------------------------|------------|------------------------------|----------|------------------|---------------|-----------------------|----------------|
| LQW04AN23NJ00□ | 23nH ±5% | 100MHz | 15 | 250MHz | 160mA | 0.95Ω | 4.0GHz |
| LQW04AN24NH00□ | 24nH ±3% | 100MHz | 15 | 250MHz | 160mA | 0.95Ω | 4.0GHz |
| LQW04AN24NJ00□ | 24nH ±5% | 100MHz | 15 | 250MHz | 160mA | 0.95Ω | 4.0GHz |
| LQW04AN25NH00□ | 25nH ±3% | 100MHz | 15 | 250MHz | 160mA | 0.95Ω | 4.0GHz |
| LQW04AN25NJ00□ | 25nH ±5% | 100MHz | 15 | 250MHz | 160mA | 0.95Ω | 4.0GHz |
| LQW04AN27NH00□ | 27nH ±3% | 100MHz | 15 | 250MHz | 160mA | 0.95Ω | 4.0GHz |
| LQW04AN27NJ00□ | 27nH ±5% | 100MHz | 15 | 250MHz | 160mA | 0.95Ω | 4.0GHz |
| LQW04AN33NH00□ | 33nH ±3% | 100MHz | 15 | 250MHz | 140mA | 1.11Ω | 4.0GHz |
| LQW04AN33NJ00□ | 33nH ±5% | 100MHz | 15 | 250MHz | 140mA | 1.11Ω | 4.0GHz |

Operating temp. range: -55 to 125°C

Only for reflow soldering

*S.R.F.: Self Resonant Frequency

Inductance-Frequency Characteristics (Typ.)



Q-Frequency Characteristics (Typ.)

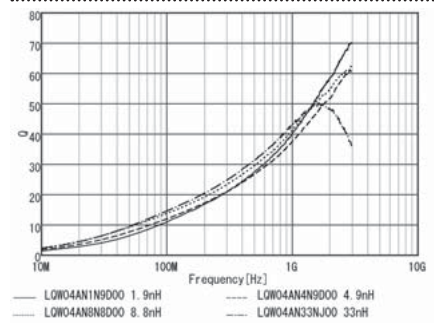

LQW04AN_10 Series 03015 (0804) inch (mm)



(in mm)

| Packaging Code | Packaging | Minimum Quantity |
|----------------|---------------------|------------------|
| D | ø180mm Paper Taping | 10000 |
| B | Packing in Bulk | 500 |

| Part Number (□: packaging code) | Inductance | Inductance Test Frequency | Q (min.) | Q Test Frequency | Rated Current | Max. of DC Resistance | S.R.F.* (min.) |
|------------------------------------|------------|------------------------------|----------|------------------|---------------|-----------------------|----------------|
| LQW04AN36NJ10□ | 36nH ±5% | 100MHz | 18 | 250MHz | 200mA | 1.08Ω | 2.1GHz |
| LQW04AN39NJ10□ | 39nH ±5% | 100MHz | 16 | 250MHz | 200mA | 1.08Ω | 1.2GHz |
| LQW04AN43NJ10□ | 43nH ±5% | 100MHz | 15 | 250MHz | 180mA | 1.2Ω | 1.6GHz |
| LQW04AN47NJ10□ | 47nH ±5% | 100MHz | 16 | 250MHz | 180mA | 1.2Ω | 1.6GHz |
| LQW04AN52NJ10□ | 52nH ±5% | 100MHz | 15 | 250MHz | 180mA | 1.32Ω | 1.4GHz |
| LQW04AN56NJ10□ | 56nH ±5% | 100MHz | 13 | 250MHz | 180mA | 1.32Ω | 1.2GHz |

Operating temp. range: -55 to 125°C

Only for reflow soldering

*S.R.F.: Self Resonant Frequency

Continued on the following page. ↗

Continued from the preceding page. ↘

Inductance-Frequency Characteristics (Typ.)



Q-Frequency Characteristics (Typ.)



LQW15AN_00 Series 0402 (1005) inch (mm)



| Packaging Code | Packaging | Minimum Quantity |
|----------------|---------------------|------------------|
| D | ø180mm Paper Taping | 10000 |
| B | Packing in Bulk | 500 |

| Part Number (□: packaging code) | Inductance | Inductance Test Frequency | Q (min.) | Q Test Frequency | Rated Current | Max. of DC Resistance | S.R.F.* (min.) |
|------------------------------------|--------------|---------------------------|----------|------------------|---------------|-----------------------|----------------|
| LQW15AN1N5B00□ | 1.5nH ±0.1nH | 100MHz | 10 | 250MHz | 1000mA | 0.03Ω | 18.0GHz |
| LQW15AN1N5C00□ | 1.5nH ±0.2nH | 100MHz | 10 | 250MHz | 1000mA | 0.03Ω | 18.0GHz |
| LQW15AN1N5D00□ | 1.5nH ±0.5nH | 100MHz | 10 | 250MHz | 1000mA | 0.03Ω | 18.0GHz |
| LQW15AN1N6C00□ | 1.6nH ±0.2nH | 100MHz | 10 | 250MHz | 750mA | 0.07Ω | 17.0GHz |
| LQW15AN1N6D00□ | 1.6nH ±0.5nH | 100MHz | 10 | 250MHz | 750mA | 0.07Ω | 17.0GHz |
| LQW15AN1N7C00□ | 1.7nH ±0.2nH | 100MHz | 10 | 250MHz | 640mA | 0.10Ω | 17.0GHz |
| LQW15AN1N7D00□ | 1.7nH ±0.5nH | 100MHz | 10 | 250MHz | 640mA | 0.10Ω | 17.0GHz |
| LQW15AN1N8C00□ | 1.8nH ±0.2nH | 100MHz | 10 | 250MHz | 460mA | 0.16Ω | 16.0GHz |
| LQW15AN1N8D00□ | 1.8nH ±0.5nH | 100MHz | 10 | 250MHz | 460mA | 0.16Ω | 16.0GHz |
| LQW15AN2N4B00□ | 2.4nH ±0.1nH | 100MHz | 20 | 250MHz | 850mA | 0.05Ω | 15.0GHz |
| LQW15AN2N4C00□ | 2.4nH ±0.2nH | 100MHz | 20 | 250MHz | 850mA | 0.05Ω | 15.0GHz |
| LQW15AN2N4D00□ | 2.4nH ±0.5nH | 100MHz | 20 | 250MHz | 850mA | 0.05Ω | 15.0GHz |
| LQW15AN2N5B00□ | 2.5nH ±0.1nH | 100MHz | 20 | 250MHz | 850mA | 0.05Ω | 15.0GHz |
| LQW15AN2N5C00□ | 2.5nH ±0.2nH | 100MHz | 20 | 250MHz | 850mA | 0.05Ω | 15.0GHz |
| LQW15AN2N5D00□ | 2.5nH ±0.5nH | 100MHz | 20 | 250MHz | 850mA | 0.05Ω | 15.0GHz |
| LQW15AN2N6B00□ | 2.6nH ±0.1nH | 100MHz | 20 | 250MHz | 850mA | 0.05Ω | 15.0GHz |
| LQW15AN2N6C00□ | 2.6nH ±0.2nH | 100MHz | 20 | 250MHz | 850mA | 0.05Ω | 15.0GHz |
| LQW15AN2N6D00□ | 2.6nH ±0.5nH | 100MHz | 20 | 250MHz | 850mA | 0.05Ω | 15.0GHz |
| LQW15AN2N7B00□ | 2.7nH ±0.1nH | 100MHz | 20 | 250MHz | 850mA | 0.05Ω | 15.0GHz |
| LQW15AN2N7C00□ | 2.7nH ±0.2nH | 100MHz | 20 | 250MHz | 850mA | 0.05Ω | 15.0GHz |
| LQW15AN2N7D00□ | 2.7nH ±0.5nH | 100MHz | 20 | 250MHz | 850mA | 0.05Ω | 15.0GHz |
| LQW15AN2N8B00□ | 2.8nH ±0.1nH | 100MHz | 20 | 250MHz | 850mA | 0.05Ω | 15.0GHz |
| LQW15AN2N8C00□ | 2.8nH ±0.2nH | 100MHz | 20 | 250MHz | 850mA | 0.05Ω | 15.0GHz |
| LQW15AN2N8D00□ | 2.8nH ±0.5nH | 100MHz | 20 | 250MHz | 850mA | 0.05Ω | 15.0GHz |
| LQW15AN2N9B00□ | 2.9nH ±0.1nH | 100MHz | 20 | 250MHz | 750mA | 0.07Ω | 15.0GHz |
| LQW15AN2N9C00□ | 2.9nH ±0.2nH | 100MHz | 20 | 250MHz | 750mA | 0.07Ω | 15.0GHz |

Operating temp. range: -55 to 125°C
 Only for reflow soldering
 *S.R.F.: Self Resonant Frequency

Continued on the following page. ↗

Continued from the preceding page. ↘

| Part Number (□: packaging code) | Inductance | Inductance Test Frequency | Q (min.) | Q Test Frequency | Rated Current | Max. of DC Resistance | S.R.F.* (min.) |
|------------------------------------|--------------|------------------------------|----------|------------------|---------------|-----------------------|----------------|
| LQW15AN2N9D00□ | 2.9nH ±0.5nH | 100MHz | 20 | 250MHz | 750mA | 0.07Ω | 15.0GHz |
| LQW15AN3NOB00□ | 3.0nH ±0.1nH | 100MHz | 20 | 250MHz | 750mA | 0.07Ω | 15.0GHz |
| LQW15AN3NOC00□ | 3.0nH ±0.2nH | 100MHz | 20 | 250MHz | 750mA | 0.07Ω | 15.0GHz |
| LQW15AN3NOD00□ | 3.0nH ±0.5nH | 100MHz | 20 | 250MHz | 750mA | 0.07Ω | 15.0GHz |
| LQW15AN3N1B00□ | 3.1nH ±0.1nH | 100MHz | 20 | 250MHz | 570mA | 0.13Ω | 14.0GHz |
| LQW15AN3N1C00□ | 3.1nH ±0.2nH | 100MHz | 20 | 250MHz | 570mA | 0.13Ω | 14.0GHz |
| LQW15AN3N1D00□ | 3.1nH ±0.5nH | 100MHz | 20 | 250MHz | 570mA | 0.13Ω | 14.0GHz |
| LQW15AN3N2B00□ | 3.2nH ±0.1nH | 100MHz | 15 | 250MHz | 500mA | 0.17Ω | 14.0GHz |
| LQW15AN3N2C00□ | 3.2nH ±0.2nH | 100MHz | 15 | 250MHz | 500mA | 0.17Ω | 14.0GHz |
| LQW15AN3N2D00□ | 3.2nH ±0.5nH | 100MHz | 15 | 250MHz | 500mA | 0.17Ω | 14.0GHz |
| LQW15AN3N9B00□ | 3.9nH ±0.1nH | 100MHz | 25 | 250MHz | 750mA | 0.07Ω | 10.0GHz |
| LQW15AN3N9C00□ | 3.9nH ±0.2nH | 100MHz | 25 | 250MHz | 750mA | 0.07Ω | 10.0GHz |
| LQW15AN3N9D00□ | 3.9nH ±0.5nH | 100MHz | 25 | 250MHz | 750mA | 0.07Ω | 10.0GHz |
| LQW15AN4N1B00□ | 4.1nH ±0.1nH | 100MHz | 25 | 250MHz | 750mA | 0.07Ω | 10.0GHz |
| LQW15AN4N1C00□ | 4.1nH ±0.2nH | 100MHz | 25 | 250MHz | 750mA | 0.07Ω | 10.0GHz |
| LQW15AN4N1D00□ | 4.1nH ±0.5nH | 100MHz | 25 | 250MHz | 750mA | 0.07Ω | 10.0GHz |
| LQW15AN4N3B00□ | 4.3nH ±0.1nH | 100MHz | 25 | 250MHz | 750mA | 0.07Ω | 10.0GHz |
| LQW15AN4N3C00□ | 4.3nH ±0.2nH | 100MHz | 25 | 250MHz | 750mA | 0.07Ω | 10.0GHz |
| LQW15AN4N3D00□ | 4.3nH ±0.5nH | 100MHz | 25 | 250MHz | 750mA | 0.07Ω | 10.0GHz |
| LQW15AN4N4B00□ | 4.4nH ±0.1nH | 100MHz | 25 | 250MHz | 750mA | 0.07Ω | 8.0GHz |
| LQW15AN4N4C00□ | 4.4nH ±0.2nH | 100MHz | 25 | 250MHz | 750mA | 0.07Ω | 8.0GHz |
| LQW15AN4N4D00□ | 4.4nH ±0.5nH | 100MHz | 25 | 250MHz | 750mA | 0.07Ω | 8.0GHz |
| LQW15AN4N5B00□ | 4.5nH ±0.1nH | 100MHz | 25 | 250MHz | 750mA | 0.07Ω | 8.0GHz |
| LQW15AN4N5C00□ | 4.5nH ±0.2nH | 100MHz | 25 | 250MHz | 750mA | 0.07Ω | 8.0GHz |
| LQW15AN4N5D00□ | 4.5nH ±0.5nH | 100MHz | 25 | 250MHz | 750mA | 0.07Ω | 8.0GHz |
| LQW15AN4N6B00□ | 4.6nH ±0.1nH | 100MHz | 25 | 250MHz | 750mA | 0.07Ω | 8.0GHz |
| LQW15AN4N6C00□ | 4.6nH ±0.2nH | 100MHz | 25 | 250MHz | 750mA | 0.07Ω | 8.0GHz |
| LQW15AN4N6D00□ | 4.6nH ±0.5nH | 100MHz | 25 | 250MHz | 750mA | 0.07Ω | 8.0GHz |
| LQW15AN4N7B00□ | 4.7nH ±0.1nH | 100MHz | 25 | 250MHz | 750mA | 0.07Ω | 8.0GHz |
| LQW15AN4N7C00□ | 4.7nH ±0.2nH | 100MHz | 25 | 250MHz | 750mA | 0.07Ω | 8.0GHz |
| LQW15AN4N7D00□ | 4.7nH ±0.5nH | 100MHz | 25 | 250MHz | 750mA | 0.07Ω | 8.0GHz |
| LQW15AN4N8B00□ | 4.8nH ±0.1nH | 100MHz | 25 | 250MHz | 750mA | 0.07Ω | 8.0GHz |
| LQW15AN4N8C00□ | 4.8nH ±0.2nH | 100MHz | 25 | 250MHz | 750mA | 0.07Ω | 8.0GHz |
| LQW15AN4N8D00□ | 4.8nH ±0.5nH | 100MHz | 25 | 250MHz | 750mA | 0.07Ω | 8.0GHz |
| LQW15AN4N9B00□ | 4.9nH ±0.1nH | 100MHz | 25 | 250MHz | 600mA | 0.12Ω | 8.0GHz |
| LQW15AN4N9C00□ | 4.9nH ±0.2nH | 100MHz | 25 | 250MHz | 600mA | 0.12Ω | 8.0GHz |
| LQW15AN4N9D00□ | 4.9nH ±0.5nH | 100MHz | 25 | 250MHz | 600mA | 0.12Ω | 8.0GHz |
| LQW15AN5NOB00□ | 5.0nH ±0.1nH | 100MHz | 25 | 250MHz | 600mA | 0.12Ω | 8.0GHz |
| LQW15AN5NOC00□ | 5.0nH ±0.2nH | 100MHz | 25 | 250MHz | 600mA | 0.12Ω | 8.0GHz |
| LQW15AN5NOD00□ | 5.0nH ±0.5nH | 100MHz | 25 | 250MHz | 600mA | 0.12Ω | 8.0GHz |
| LQW15AN5N1B00□ | 5.1nH ±0.1nH | 100MHz | 25 | 250MHz | 600mA | 0.12Ω | 8.0GHz |
| LQW15AN5N1C00□ | 5.1nH ±0.2nH | 100MHz | 25 | 250MHz | 600mA | 0.12Ω | 8.0GHz |
| LQW15AN5N1D00□ | 5.1nH ±0.5nH | 100MHz | 25 | 250MHz | 600mA | 0.12Ω | 8.0GHz |
| LQW15AN5N8B00□ | 5.8nH ±0.1nH | 100MHz | 25 | 250MHz | 700mA | 0.09Ω | 8.0GHz |
| LQW15AN5N8C00□ | 5.8nH ±0.2nH | 100MHz | 25 | 250MHz | 700mA | 0.09Ω | 8.0GHz |
| LQW15AN5N8D00□ | 5.8nH ±0.5nH | 100MHz | 25 | 250MHz | 700mA | 0.09Ω | 8.0GHz |
| LQW15AN6N2B00□ | 6.2nH ±0.1nH | 100MHz | 25 | 250MHz | 700mA | 0.09Ω | 8.0GHz |
| LQW15AN6N2C00□ | 6.2nH ±0.2nH | 100MHz | 25 | 250MHz | 700mA | 0.09Ω | 8.0GHz |
| LQW15AN6N2D00□ | 6.2nH ±0.5nH | 100MHz | 25 | 250MHz | 700mA | 0.09Ω | 8.0GHz |
| LQW15AN6N3B00□ | 6.3nH ±0.1nH | 100MHz | 25 | 250MHz | 700mA | 0.09Ω | 6.0GHz |
| LQW15AN6N3C00□ | 6.3nH ±0.2nH | 100MHz | 25 | 250MHz | 700mA | 0.09Ω | 6.0GHz |
| LQW15AN6N3D00□ | 6.3nH ±0.5nH | 100MHz | 25 | 250MHz | 700mA | 0.09Ω | 6.0GHz |
| LQW15AN6N4B00□ | 6.4nH ±0.1nH | 100MHz | 25 | 250MHz | 700mA | 0.09Ω | 6.0GHz |

Operating temp. range: -55 to 125°C
 Only for reflow soldering
 *S.R.F.: Self Resonant Frequency

Continued on the following page. ↗

Continued from the preceding page. ↘

| Part Number (□: packaging code) | Inductance | Inductance Test Frequency | Q (min.) | Q Test Frequency | Rated Current | Max. of DC Resistance | S.R.F.* (min.) |
|------------------------------------|--------------|------------------------------|----------|------------------|---------------|-----------------------|----------------|
| LQW15AN6N4C00□ | 6.4nH ±0.2nH | 100MHz | 25 | 250MHz | 700mA | 0.09Ω | 6.0GHz |
| LQW15AN6N4D00□ | 6.4nH ±0.5nH | 100MHz | 25 | 250MHz | 700mA | 0.09Ω | 6.0GHz |
| LQW15AN6N5B00□ | 6.5nH ±0.1nH | 100MHz | 25 | 250MHz | 700mA | 0.09Ω | 6.0GHz |
| LQW15AN6N5C00□ | 6.5nH ±0.2nH | 100MHz | 25 | 250MHz | 700mA | 0.09Ω | 6.0GHz |
| LQW15AN6N5D00□ | 6.5nH ±0.5nH | 100MHz | 25 | 250MHz | 700mA | 0.09Ω | 6.0GHz |
| LQW15AN6N6B00□ | 6.6nH ±0.1nH | 100MHz | 25 | 250MHz | 700mA | 0.09Ω | 6.0GHz |
| LQW15AN6N6C00□ | 6.6nH ±0.2nH | 100MHz | 25 | 250MHz | 700mA | 0.09Ω | 6.0GHz |
| LQW15AN6N6D00□ | 6.6nH ±0.5nH | 100MHz | 25 | 250MHz | 700mA | 0.09Ω | 6.0GHz |
| LQW15AN6N7B00□ | 6.7nH ±0.1nH | 100MHz | 25 | 250MHz | 700mA | 0.09Ω | 6.0GHz |
| LQW15AN6N7C00□ | 6.7nH ±0.2nH | 100MHz | 25 | 250MHz | 700mA | 0.09Ω | 6.0GHz |
| LQW15AN6N7D00□ | 6.7nH ±0.5nH | 100MHz | 25 | 250MHz | 700mA | 0.09Ω | 6.0GHz |
| LQW15AN6N8G00□ | 6.8nH ±2% | 100MHz | 25 | 250MHz | 700mA | 0.09Ω | 6.0GHz |
| LQW15AN6N8H00□ | 6.8nH ±3% | 100MHz | 25 | 250MHz | 700mA | 0.09Ω | 6.0GHz |
| LQW15AN6N8J00□ | 6.8nH ±5% | 100MHz | 25 | 250MHz | 700mA | 0.09Ω | 6.0GHz |
| LQW15AN6N9G00□ | 6.9nH ±2% | 100MHz | 25 | 250MHz | 570mA | 0.13Ω | 6.0GHz |
| LQW15AN6N9H00□ | 6.9nH ±3% | 100MHz | 25 | 250MHz | 570mA | 0.13Ω | 6.0GHz |
| LQW15AN6N9J00□ | 6.9nH ±5% | 100MHz | 25 | 250MHz | 570mA | 0.13Ω | 6.0GHz |
| LQW15AN7N0G00□ | 7.0nH ±2% | 100MHz | 25 | 250MHz | 570mA | 0.13Ω | 6.0GHz |
| LQW15AN7N0H00□ | 7.0nH ±3% | 100MHz | 25 | 250MHz | 570mA | 0.13Ω | 6.0GHz |
| LQW15AN7N0J00□ | 7.0nH ±5% | 100MHz | 25 | 250MHz | 570mA | 0.13Ω | 6.0GHz |
| LQW15AN7N1G00□ | 7.1nH ±2% | 100MHz | 25 | 250MHz | 570mA | 0.13Ω | 6.0GHz |
| LQW15AN7N1H00□ | 7.1nH ±3% | 100MHz | 25 | 250MHz | 570mA | 0.13Ω | 6.0GHz |
| LQW15AN7N1J00□ | 7.1nH ±5% | 100MHz | 25 | 250MHz | 570mA | 0.13Ω | 6.0GHz |
| LQW15AN7N2G00□ | 7.2nH ±2% | 100MHz | 25 | 250MHz | 570mA | 0.13Ω | 6.0GHz |
| LQW15AN7N2H00□ | 7.2nH ±3% | 100MHz | 25 | 250MHz | 570mA | 0.13Ω | 6.0GHz |
| LQW15AN7N2J00□ | 7.2nH ±5% | 100MHz | 25 | 250MHz | 570mA | 0.13Ω | 6.0GHz |
| LQW15AN7N3G00□ | 7.3nH ±2% | 100MHz | 25 | 250MHz | 570mA | 0.13Ω | 6.0GHz |
| LQW15AN7N3H00□ | 7.3nH ±3% | 100MHz | 25 | 250MHz | 570mA | 0.13Ω | 6.0GHz |
| LQW15AN7N3J00□ | 7.3nH ±5% | 100MHz | 25 | 250MHz | 570mA | 0.13Ω | 6.0GHz |
| LQW15AN7N5G00□ | 7.5nH ±2% | 100MHz | 25 | 250MHz | 570mA | 0.13Ω | 6.0GHz |
| LQW15AN7N5H00□ | 7.5nH ±3% | 100MHz | 25 | 250MHz | 570mA | 0.13Ω | 6.0GHz |
| LQW15AN7N5J00□ | 7.5nH ±5% | 100MHz | 25 | 250MHz | 570mA | 0.13Ω | 6.0GHz |
| LQW15AN8N2G00□ | 8.2nH ±2% | 100MHz | 25 | 250MHz | 540mA | 0.14Ω | 5.5GHz |
| LQW15AN8N2H00□ | 8.2nH ±3% | 100MHz | 25 | 250MHz | 540mA | 0.14Ω | 5.5GHz |
| LQW15AN8N2J00□ | 8.2nH ±5% | 100MHz | 25 | 250MHz | 540mA | 0.14Ω | 5.5GHz |
| LQW15AN8N6G00□ | 8.6nH ±2% | 100MHz | 25 | 250MHz | 540mA | 0.14Ω | 5.5GHz |
| LQW15AN8N6H00□ | 8.6nH ±3% | 100MHz | 25 | 250MHz | 540mA | 0.14Ω | 5.5GHz |
| LQW15AN8N6J00□ | 8.6nH ±5% | 100MHz | 25 | 250MHz | 540mA | 0.14Ω | 5.5GHz |
| LQW15AN8N7G00□ | 8.7nH ±2% | 100MHz | 25 | 250MHz | 540mA | 0.14Ω | 5.5GHz |
| LQW15AN8N7H00□ | 8.7nH ±3% | 100MHz | 25 | 250MHz | 540mA | 0.14Ω | 5.5GHz |
| LQW15AN8N7J00□ | 8.7nH ±5% | 100MHz | 25 | 250MHz | 540mA | 0.14Ω | 5.5GHz |
| LQW15AN8N8G00□ | 8.8nH ±2% | 100MHz | 25 | 250MHz | 540mA | 0.14Ω | 5.5GHz |
| LQW15AN8N8H00□ | 8.8nH ±3% | 100MHz | 25 | 250MHz | 540mA | 0.14Ω | 5.5GHz |
| LQW15AN8N8J00□ | 8.8nH ±5% | 100MHz | 25 | 250MHz | 540mA | 0.14Ω | 5.5GHz |
| LQW15AN8N9G00□ | 8.9nH ±2% | 100MHz | 25 | 250MHz | 540mA | 0.14Ω | 5.5GHz |
| LQW15AN8N9H00□ | 8.9nH ±3% | 100MHz | 25 | 250MHz | 540mA | 0.14Ω | 5.5GHz |
| LQW15AN8N9J00□ | 8.9nH ±5% | 100MHz | 25 | 250MHz | 540mA | 0.14Ω | 5.5GHz |
| LQW15AN9N0G00□ | 9.0nH ±2% | 100MHz | 25 | 250MHz | 540mA | 0.14Ω | 5.5GHz |
| LQW15AN9N0H00□ | 9.0nH ±3% | 100MHz | 25 | 250MHz | 540mA | 0.14Ω | 5.5GHz |
| LQW15AN9N0J00□ | 9.0nH ±5% | 100MHz | 25 | 250MHz | 540mA | 0.14Ω | 5.5GHz |
| LQW15AN9N1G00□ | 9.1nH ±2% | 100MHz | 25 | 250MHz | 540mA | 0.14Ω | 5.5GHz |
| LQW15AN9N1H00□ | 9.1nH ±3% | 100MHz | 25 | 250MHz | 540mA | 0.14Ω | 5.5GHz |
| LQW15AN9N1J00□ | 9.1nH ±5% | 100MHz | 25 | 250MHz | 540mA | 0.14Ω | 5.5GHz |

Operating temp. range: -55 to 125°C
 Only for reflow soldering
 *S.R.F.: Self Resonant Frequency

Continued on the following page. ↗

Continued from the preceding page. ↘

| Part Number (□: packaging code) | Inductance | Inductance Test Frequency | Q (min.) | Q Test Frequency | Rated Current | Max. of DC Resistance | S.R.F.* (min.) |
|------------------------------------|------------|------------------------------|----------|------------------|---------------|-----------------------|----------------|
| LQW15AN9N2G00□ | 9.2nH ±2% | 100MHz | 25 | 250MHz | 540mA | 0.14Ω | 5.5GHz |
| LQW15AN9N2H00□ | 9.2nH ±3% | 100MHz | 25 | 250MHz | 540mA | 0.14Ω | 5.5GHz |
| LQW15AN9N2J00□ | 9.2nH ±5% | 100MHz | 25 | 250MHz | 540mA | 0.14Ω | 5.5GHz |
| LQW15AN9N3G00□ | 9.3nH ±2% | 100MHz | 25 | 250MHz | 540mA | 0.14Ω | 5.5GHz |
| LQW15AN9N3H00□ | 9.3nH ±3% | 100MHz | 25 | 250MHz | 540mA | 0.14Ω | 5.5GHz |
| LQW15AN9N3J00□ | 9.3nH ±5% | 100MHz | 25 | 250MHz | 540mA | 0.14Ω | 5.5GHz |
| LQW15AN9N4G00□ | 9.4nH ±2% | 100MHz | 25 | 250MHz | 540mA | 0.14Ω | 5.5GHz |
| LQW15AN9N4H00□ | 9.4nH ±3% | 100MHz | 25 | 250MHz | 540mA | 0.14Ω | 5.5GHz |
| LQW15AN9N4J00□ | 9.4nH ±5% | 100MHz | 25 | 250MHz | 540mA | 0.14Ω | 5.5GHz |
| LQW15AN9N5G00□ | 9.5nH ±2% | 100MHz | 25 | 250MHz | 540mA | 0.14Ω | 5.5GHz |
| LQW15AN9N5H00□ | 9.5nH ±3% | 100MHz | 25 | 250MHz | 540mA | 0.14Ω | 5.5GHz |
| LQW15AN9N5J00□ | 9.5nH ±5% | 100MHz | 25 | 250MHz | 540mA | 0.14Ω | 5.5GHz |
| LQW15AN9N6G00□ | 9.6nH ±2% | 100MHz | 25 | 250MHz | 540mA | 0.14Ω | 5.5GHz |
| LQW15AN9N6H00□ | 9.6nH ±3% | 100MHz | 25 | 250MHz | 540mA | 0.14Ω | 5.5GHz |
| LQW15AN9N6J00□ | 9.6nH ±5% | 100MHz | 25 | 250MHz | 540mA | 0.14Ω | 5.5GHz |
| LQW15AN9N7G00□ | 9.7nH ±2% | 100MHz | 25 | 250MHz | 540mA | 0.14Ω | 5.5GHz |
| LQW15AN9N7H00□ | 9.7nH ±3% | 100MHz | 25 | 250MHz | 540mA | 0.14Ω | 5.5GHz |
| LQW15AN9N7J00□ | 9.7nH ±5% | 100MHz | 25 | 250MHz | 540mA | 0.14Ω | 5.5GHz |
| LQW15AN9N8G00□ | 9.8nH ±2% | 100MHz | 25 | 250MHz | 540mA | 0.14Ω | 5.5GHz |
| LQW15AN9N8H00□ | 9.8nH ±3% | 100MHz | 25 | 250MHz | 540mA | 0.14Ω | 5.5GHz |
| LQW15AN9N8J00□ | 9.8nH ±5% | 100MHz | 25 | 250MHz | 540mA | 0.14Ω | 5.5GHz |
| LQW15AN9N9G00□ | 9.9nH ±2% | 100MHz | 25 | 250MHz | 540mA | 0.14Ω | 5.5GHz |
| LQW15AN9N9H00□ | 9.9nH ±3% | 100MHz | 25 | 250MHz | 540mA | 0.14Ω | 5.5GHz |
| LQW15AN9N9J00□ | 9.9nH ±5% | 100MHz | 25 | 250MHz | 540mA | 0.14Ω | 5.5GHz |
| LQW15AN10NG00□ | 10nH ±2% | 100MHz | 25 | 250MHz | 500mA | 0.17Ω | 5.5GHz |
| LQW15AN10NH00□ | 10nH ±3% | 100MHz | 25 | 250MHz | 500mA | 0.17Ω | 5.5GHz |
| LQW15AN10NJ00□ | 10nH ±5% | 100MHz | 25 | 250MHz | 500mA | 0.17Ω | 5.5GHz |
| LQW15AN11NG00□ | 11nH ±2% | 100MHz | 30 | 250MHz | 500mA | 0.14Ω | 5.5GHz |
| LQW15AN11NH00□ | 11nH ±3% | 100MHz | 30 | 250MHz | 500mA | 0.14Ω | 5.5GHz |
| LQW15AN11NJ00□ | 11nH ±5% | 100MHz | 30 | 250MHz | 500mA | 0.14Ω | 5.5GHz |
| LQW15AN12NG00□ | 12nH ±2% | 100MHz | 30 | 250MHz | 500mA | 0.14Ω | 5.5GHz |
| LQW15AN12NH00□ | 12nH ±3% | 100MHz | 30 | 250MHz | 500mA | 0.14Ω | 5.5GHz |
| LQW15AN12NJ00□ | 12nH ±5% | 100MHz | 30 | 250MHz | 500mA | 0.14Ω | 5.5GHz |
| LQW15AN13NG00□ | 13nH ±2% | 100MHz | 25 | 250MHz | 430mA | 0.21Ω | 5.0GHz |
| LQW15AN13NH00□ | 13nH ±3% | 100MHz | 25 | 250MHz | 430mA | 0.21Ω | 5.0GHz |
| LQW15AN13NJ00□ | 13nH ±5% | 100MHz | 25 | 250MHz | 430mA | 0.21Ω | 5.0GHz |
| LQW15AN15NG00□ | 15nH ±2% | 100MHz | 30 | 250MHz | 460mA | 0.16Ω | 5.0GHz |
| LQW15AN15NH00□ | 15nH ±3% | 100MHz | 30 | 250MHz | 460mA | 0.16Ω | 5.0GHz |
| LQW15AN15NJ00□ | 15nH ±5% | 100MHz | 30 | 250MHz | 460mA | 0.16Ω | 5.0GHz |
| LQW15AN16NG00□ | 16nH ±2% | 100MHz | 25 | 250MHz | 370mA | 0.24Ω | 4.5GHz |
| LQW15AN16NH00□ | 16nH ±3% | 100MHz | 25 | 250MHz | 370mA | 0.24Ω | 4.5GHz |
| LQW15AN16NJ00□ | 16nH ±5% | 100MHz | 25 | 250MHz | 370mA | 0.24Ω | 4.5GHz |
| LQW15AN18NG00□ | 18nH ±2% | 100MHz | 25 | 250MHz | 370mA | 0.27Ω | 4.5GHz |
| LQW15AN18NH00□ | 18nH ±3% | 100MHz | 25 | 250MHz | 370mA | 0.27Ω | 4.5GHz |
| LQW15AN18NJ00□ | 18nH ±5% | 100MHz | 25 | 250MHz | 370mA | 0.27Ω | 4.5GHz |
| LQW15AN19NG00□ | 19nH ±2% | 100MHz | 25 | 250MHz | 370mA | 0.27Ω | 4.5GHz |
| LQW15AN19NH00□ | 19nH ±3% | 100MHz | 25 | 250MHz | 370mA | 0.27Ω | 4.5GHz |
| LQW15AN19NJ00□ | 19nH ±5% | 100MHz | 25 | 250MHz | 370mA | 0.27Ω | 4.5GHz |
| LQW15AN20NG00□ | 20nH ±2% | 100MHz | 25 | 250MHz | 370mA | 0.27Ω | 4.0GHz |
| LQW15AN20NH00□ | 20nH ±3% | 100MHz | 25 | 250MHz | 370mA | 0.27Ω | 4.0GHz |
| LQW15AN20NJ00□ | 20nH ±5% | 100MHz | 25 | 250MHz | 370mA | 0.27Ω | 4.0GHz |
| LQW15AN22NG00□ | 22nH ±2% | 100MHz | 25 | 250MHz | 310mA | 0.30Ω | 4.0GHz |
| LQW15AN22NH00□ | 22nH ±3% | 100MHz | 25 | 250MHz | 310mA | 0.30Ω | 4.0GHz |

Operating temp. range: -55 to 125°C
 Only for reflow soldering
 *S.R.F.: Self Resonant Frequency

Continued on the following page. ↗

Continued from the preceding page. ↘

| Part Number (□: packaging code) | Inductance | Inductance Test Frequency | Q (min.) | Q Test Frequency | Rated Current | Max. of DC Resistance | S.R.F.* (min.) |
|------------------------------------|------------|------------------------------|----------|------------------|---------------|-----------------------|----------------|
| LQW15AN22NJ00□ | 22nH ±5% | 100MHz | 25 | 250MHz | 310mA | 0.30Ω | 4.0GHz |
| LQW15AN23NG00□ | 23nH ±2% | 100MHz | 25 | 250MHz | 310mA | 0.30Ω | 3.8GHz |
| LQW15AN23NH00□ | 23nH ±3% | 100MHz | 25 | 250MHz | 310mA | 0.30Ω | 3.8GHz |
| LQW15AN23NJ00□ | 23nH ±5% | 100MHz | 25 | 250MHz | 310mA | 0.30Ω | 3.8GHz |
| LQW15AN24NG00□ | 24nH ±2% | 100MHz | 25 | 250MHz | 280mA | 0.52Ω | 3.5GHz |
| LQW15AN24NH00□ | 24nH ±3% | 100MHz | 25 | 250MHz | 280mA | 0.52Ω | 3.5GHz |
| LQW15AN24NJ00□ | 24nH ±5% | 100MHz | 25 | 250MHz | 280mA | 0.52Ω | 3.5GHz |
| LQW15AN27NG00□ | 27nH ±2% | 100MHz | 25 | 250MHz | 280mA | 0.52Ω | 3.5GHz |
| LQW15AN27NH00□ | 27nH ±3% | 100MHz | 25 | 250MHz | 280mA | 0.52Ω | 3.5GHz |
| LQW15AN27NJ00□ | 27nH ±5% | 100MHz | 25 | 250MHz | 280mA | 0.52Ω | 3.5GHz |
| LQW15AN30NG00□ | 30nH ±2% | 100MHz | 25 | 250MHz | 270mA | 0.58Ω | 3.3GHz |
| LQW15AN30NH00□ | 30nH ±3% | 100MHz | 25 | 250MHz | 270mA | 0.58Ω | 3.3GHz |
| LQW15AN30NJ00□ | 30nH ±5% | 100MHz | 25 | 250MHz | 270mA | 0.58Ω | 3.3GHz |
| LQW15AN33NG00□ | 33nH ±2% | 100MHz | 25 | 250MHz | 260mA | 0.63Ω | 3.2GHz |
| LQW15AN33NH00□ | 33nH ±3% | 100MHz | 25 | 250MHz | 260mA | 0.63Ω | 3.2GHz |
| LQW15AN33NJ00□ | 33nH ±5% | 100MHz | 25 | 250MHz | 260mA | 0.63Ω | 3.2GHz |
| LQW15AN36NG00□ | 36nH ±2% | 100MHz | 25 | 250MHz | 260mA | 0.63Ω | 3.1GHz |
| LQW15AN36NH00□ | 36nH ±3% | 100MHz | 25 | 250MHz | 260mA | 0.63Ω | 3.1GHz |
| LQW15AN36NJ00□ | 36nH ±5% | 100MHz | 25 | 250MHz | 260mA | 0.63Ω | 3.1GHz |
| LQW15AN39NG00□ | 39nH ±2% | 100MHz | 25 | 250MHz | 250mA | 0.70Ω | 3.0GHz |
| LQW15AN39NH00□ | 39nH ±3% | 100MHz | 25 | 250MHz | 250mA | 0.70Ω | 3.0GHz |
| LQW15AN39NJ00□ | 39nH ±5% | 100MHz | 25 | 250MHz | 250mA | 0.70Ω | 3.0GHz |
| LQW15AN40NG00□ | 40nH ±2% | 100MHz | 25 | 250MHz | 250mA | 0.70Ω | 3.0GHz |
| LQW15AN40NH00□ | 40nH ±3% | 100MHz | 25 | 250MHz | 250mA | 0.70Ω | 3.0GHz |
| LQW15AN40NJ00□ | 40nH ±5% | 100MHz | 25 | 250MHz | 250mA | 0.70Ω | 3.0GHz |
| LQW15AN43NG00□ | 43nH ±2% | 100MHz | 25 | 250MHz | 250mA | 0.70Ω | 3.0GHz |
| LQW15AN43NH00□ | 43nH ±3% | 100MHz | 25 | 250MHz | 250mA | 0.70Ω | 3.0GHz |
| LQW15AN43NJ00□ | 43nH ±5% | 100MHz | 25 | 250MHz | 250mA | 0.70Ω | 3.0GHz |
| LQW15AN47NG00□ | 47nH ±2% | 100MHz | 25 | 200MHz | 210mA | 1.08Ω | 2.9GHz |
| LQW15AN47NH00□ | 47nH ±3% | 100MHz | 25 | 200MHz | 210mA | 1.08Ω | 2.9GHz |
| LQW15AN47NJ00□ | 47nH ±5% | 100MHz | 25 | 200MHz | 210mA | 1.08Ω | 2.9GHz |
| LQW15AN51NG00□ | 51nH ±2% | 100MHz | 25 | 200MHz | 210mA | 1.08Ω | 2.85GHz |
| LQW15AN51NH00□ | 51nH ±3% | 100MHz | 25 | 200MHz | 210mA | 1.08Ω | 2.85GHz |
| LQW15AN51NJ00□ | 51nH ±5% | 100MHz | 25 | 200MHz | 210mA | 1.08Ω | 2.85GHz |
| LQW15AN56NG00□ | 56nH ±2% | 100MHz | 25 | 200MHz | 200mA | 1.17Ω | 2.8GHz |
| LQW15AN56NH00□ | 56nH ±3% | 100MHz | 25 | 200MHz | 200mA | 1.17Ω | 2.8GHz |
| LQW15AN56NJ00□ | 56nH ±5% | 100MHz | 25 | 200MHz | 200mA | 1.17Ω | 2.8GHz |
| LQW15AN62NG00□ | 62nH ±2% | 100MHz | 20 | 200MHz | 145mA | 1.82Ω | 2.6GHz |
| LQW15AN62NH00□ | 62nH ±3% | 100MHz | 20 | 200MHz | 145mA | 1.82Ω | 2.6GHz |
| LQW15AN62NJ00□ | 62nH ±5% | 100MHz | 20 | 200MHz | 145mA | 1.82Ω | 2.6GHz |
| LQW15AN68NG00□ | 68nH ±2% | 100MHz | 20 | 200MHz | 140mA | 1.96Ω | 2.5GHz |
| LQW15AN68NJ00□ | 68nH ±5% | 100MHz | 20 | 200MHz | 140mA | 1.96Ω | 2.5GHz |
| LQW15AN72NG00□ | 72nH ±2% | 100MHz | 20 | 150MHz | 135mA | 2.10Ω | 2.5GHz |
| LQW15AN72NJ00□ | 72nH ±5% | 100MHz | 20 | 150MHz | 135mA | 2.10Ω | 2.5GHz |
| LQW15AN75NG00□ | 75nH ±2% | 100MHz | 20 | 150MHz | 135mA | 2.10Ω | 2.4GHz |
| LQW15AN75NJ00□ | 75nH ±5% | 100MHz | 20 | 150MHz | 135mA | 2.10Ω | 2.4GHz |
| LQW15AN82NG00□ | 82nH ±2% | 100MHz | 20 | 150MHz | 130mA | 2.24Ω | 2.3GHz |
| LQW15AN82NJ00□ | 82nH ±5% | 100MHz | 20 | 150MHz | 130mA | 2.24Ω | 2.3GHz |
| LQW15AN91NG00□ | 91nH ±2% | 100MHz | 20 | 150MHz | 125mA | 2.38Ω | 2.1GHz |
| LQW15AN91NJ00□ | 91nH ±5% | 100MHz | 20 | 150MHz | 125mA | 2.38Ω | 2.1GHz |
| LQW15ANR10J00□ | 100nH ±5% | 100MHz | 20 | 150MHz | 120mA | 2.52Ω | 1.5GHz |
| LQW15ANR12J00□ | 120nH ±5% | 100MHz | 20 | 150MHz | 110mA | 2.66Ω | 1.0GHz |

Operating temp. range: -55 to 125°C

Only for reflow soldering

*S.R.F.: Self Resonant Frequency

Continued on the following page. ↗

Inductors for Power Lines

Inductors for General Circuits

LQW15AN_00
RF Inductors

Continued from the preceding page. ↘

Inductance-Frequency Characteristics (Typ.)

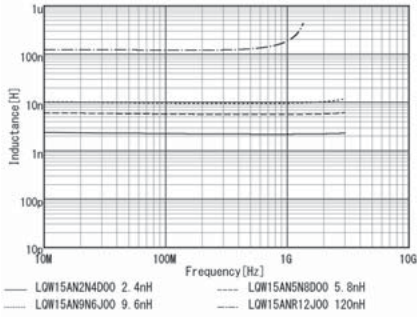

Q-Frequency Characteristics (Typ.)

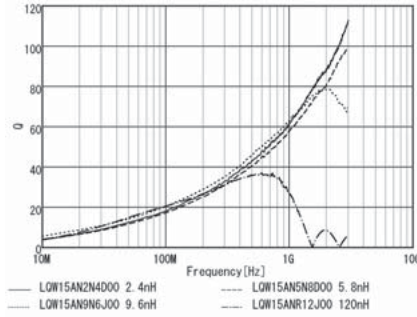

LQW15AN_10 Series 0402 (1005) inch (mm)



(in mm)

| Packaging Code | Packaging | Minimum Quantity |
|----------------|---------------------|------------------|
| D | ø180mm Paper Taping | 10000 |
| B | Packing in Bulk | 500 |

| Part Number (□: packaging code) | Inductance | Inductance Test Frequency | Q (min.) | Q Test Frequency | Rated Current | Max. of DC Resistance | S.R.F.* (min.) |
|------------------------------------|--------------|---------------------------|----------|------------------|---------------|-----------------------|----------------|
| LQW15AN1N3C10□ | 1.3nH ±0.2nH | 100MHz | 20 | 250MHz | 1200mA | 0.017Ω | 16GHz |
| LQW15AN1N3D10□ | 1.3nH ±0.5nH | 100MHz | 20 | 250MHz | 1200mA | 0.017Ω | 16GHz |
| LQW15AN1N4C10□ | 1.4nH ±0.2nH | 100MHz | 25 | 250MHz | 1100mA | 0.019Ω | 15GHz |
| LQW15AN1N4D10□ | 1.4nH ±0.5nH | 100MHz | 25 | 250MHz | 1100mA | 0.019Ω | 15GHz |
| LQW15AN2N2C10□ | 2.2nH ±0.2nH | 100MHz | 25 | 250MHz | 1000mA | 0.027Ω | 14GHz |
| LQW15AN2N2D10□ | 2.2nH ±0.5nH | 100MHz | 25 | 250MHz | 1000mA | 0.027Ω | 14GHz |
| LQW15AN2N3C10□ | 2.3nH ±0.2nH | 100MHz | 25 | 250MHz | 1000mA | 0.027Ω | 14GHz |
| LQW15AN2N3D10□ | 2.3nH ±0.5nH | 100MHz | 25 | 250MHz | 1000mA | 0.027Ω | 14GHz |
| LQW15AN2N4D10□ | 2.4nH ±0.5nH | 100MHz | 25 | 250MHz | 1000mA | 0.027Ω | 14GHz |
| LQW15AN3N3D10□ | 3.3nH ±0.5nH | 100MHz | 30 | 250MHz | 900mA | 0.040Ω | 12GHz |
| LQW15AN3N4C10□ | 3.4nH ±0.2nH | 100MHz | 30 | 250MHz | 900mA | 0.040Ω | 12GHz |
| LQW15AN3N4D10□ | 3.4nH ±0.5nH | 100MHz | 30 | 250MHz | 900mA | 0.040Ω | 12GHz |
| LQW15AN3N5C10□ | 3.5nH ±0.2nH | 100MHz | 30 | 250MHz | 900mA | 0.040Ω | 9.5GHz |
| LQW15AN3N5D10□ | 3.5nH ±0.5nH | 100MHz | 30 | 250MHz | 900mA | 0.040Ω | 9.5GHz |
| LQW15AN3N6C10□ | 3.6nH ±0.2nH | 100MHz | 30 | 250MHz | 900mA | 0.040Ω | 9.5GHz |
| LQW15AN3N6D10□ | 3.6nH ±0.5nH | 100MHz | 30 | 250MHz | 900mA | 0.040Ω | 9.5GHz |
| LQW15AN3N8C10□ | 3.8nH ±0.2nH | 100MHz | 30 | 250MHz | 900mA | 0.040Ω | 7GHz |
| LQW15AN3N8D10□ | 3.8nH ±0.5nH | 100MHz | 30 | 250MHz | 900mA | 0.040Ω | 7GHz |
| LQW15AN3N9D10□ | 3.9nH ±0.5nH | 100MHz | 30 | 250MHz | 900mA | 0.040Ω | 7GHz |
| LQW15AN4N0C10□ | 4.0nH ±0.2nH | 100MHz | 30 | 250MHz | 800mA | 0.051Ω | 6.5GHz |
| LQW15AN4N0D10□ | 4.0nH ±0.5nH | 100MHz | 30 | 250MHz | 800mA | 0.051Ω | 6.5GHz |
| LQW15AN4N2C10□ | 4.2nH ±0.2nH | 100MHz | 30 | 250MHz | 800mA | 0.051Ω | 6.5GHz |
| LQW15AN4N2D10□ | 4.2nH ±0.5nH | 100MHz | 30 | 250MHz | 800mA | 0.051Ω | 6.5GHz |
| LQW15AN4N7D10□ | 4.7nH ±0.5nH | 100MHz | 30 | 250MHz | 800mA | 0.051Ω | 8GHz |
| LQW15AN5N1C10□ | 5.1nH ±0.2nH | 100MHz | 30 | 250MHz | 800mA | 0.051Ω | 8GHz |
| LQW15AN5N1D10□ | 5.1nH ±0.5nH | 100MHz | 30 | 250MHz | 800mA | 0.051Ω | 8GHz |

Operating temp. range: -55 to 125°C

Only for reflow soldering

*S.R.F.: Self Resonant Frequency

Continued from the preceding page. ↘

| Part Number (□: packaging code) | Inductance | Inductance Test Frequency | Q (min.) | Q Test Frequency | Rated Current | Max. of DC Resistance | S.R.F.* (min.) |
|------------------------------------|--------------|------------------------------|----------|------------------|---------------|-----------------------|----------------|
| LQW15AN5N2C10□ | 5.2nH ±0.2nH | 100MHz | 30 | 250MHz | 800mA | 0.051Ω | 8GHz |
| LQW15AN5N2D10□ | 5.2nH ±0.5nH | 100MHz | 30 | 250MHz | 800mA | 0.051Ω | 8GHz |
| LQW15AN5N3C10□ | 5.3nH ±0.2nH | 100MHz | 30 | 250MHz | 800mA | 0.051Ω | 8GHz |
| LQW15AN5N3D10□ | 5.3nH ±0.5nH | 100MHz | 30 | 250MHz | 800mA | 0.051Ω | 8GHz |
| LQW15AN5N4C10□ | 5.4nH ±0.2nH | 100MHz | 30 | 250MHz | 800mA | 0.051Ω | 8GHz |
| LQW15AN5N4D10□ | 5.4nH ±0.5nH | 100MHz | 30 | 250MHz | 800mA | 0.051Ω | 8GHz |
| LQW15AN5N5C10□ | 5.5nH ±0.2nH | 100MHz | 30 | 250MHz | 800mA | 0.051Ω | 8GHz |
| LQW15AN5N5D10□ | 5.5nH ±0.5nH | 100MHz | 30 | 250MHz | 800mA | 0.051Ω | 8GHz |
| LQW15AN5N6C10□ | 5.6nH ±0.2nH | 100MHz | 30 | 250MHz | 800mA | 0.051Ω | 8GHz |
| LQW15AN5N6D10□ | 5.6nH ±0.5nH | 100MHz | 30 | 250MHz | 800mA | 0.051Ω | 8GHz |
| LQW15AN5N7C10□ | 5.7nH ±0.2nH | 100MHz | 30 | 250MHz | 800mA | 0.051Ω | 8GHz |
| LQW15AN5N7D10□ | 5.7nH ±0.5nH | 100MHz | 30 | 250MHz | 800mA | 0.051Ω | 8GHz |
| LQW15AN5N9C10□ | 5.9nH ±0.2nH | 100MHz | 30 | 250MHz | 760mA | 0.056Ω | 7.7GHz |
| LQW15AN5N9D10□ | 5.9nH ±0.5nH | 100MHz | 30 | 250MHz | 760mA | 0.056Ω | 7.7GHz |
| LQW15AN6N0C10□ | 6.0nH ±0.2nH | 100MHz | 30 | 250MHz | 760mA | 0.056Ω | 7.7GHz |
| LQW15AN6N0D10□ | 6.0nH ±0.5nH | 100MHz | 30 | 250MHz | 760mA | 0.056Ω | 7.7GHz |
| LQW15AN6N1C10□ | 6.1nH ±0.2nH | 100MHz | 30 | 250MHz | 760mA | 0.056Ω | 7.7GHz |
| LQW15AN6N1D10□ | 6.1nH ±0.5nH | 100MHz | 30 | 250MHz | 760mA | 0.056Ω | 7.7GHz |
| LQW15AN7N4C10□ | 7.4nH ±0.2nH | 100MHz | 30 | 250MHz | 750mA | 0.058Ω | 6.8GHz |
| LQW15AN7N4D10□ | 7.4nH ±0.5nH | 100MHz | 30 | 250MHz | 750mA | 0.058Ω | 6.8GHz |
| LQW15AN7N6C10□ | 7.6nH ±0.2nH | 100MHz | 30 | 250MHz | 750mA | 0.058Ω | 6.8GHz |
| LQW15AN7N6D10□ | 7.6nH ±0.5nH | 100MHz | 30 | 250MHz | 750mA | 0.058Ω | 6.8GHz |
| LQW15AN7N7C10□ | 7.7nH ±0.2nH | 100MHz | 30 | 250MHz | 750mA | 0.058Ω | 6.8GHz |
| LQW15AN7N7D10□ | 7.7nH ±0.5nH | 100MHz | 30 | 250MHz | 750mA | 0.058Ω | 6.8GHz |
| LQW15AN7N8C10□ | 7.8nH ±0.2nH | 100MHz | 30 | 250MHz | 750mA | 0.058Ω | 6.8GHz |
| LQW15AN7N8D10□ | 7.8nH ±0.5nH | 100MHz | 30 | 250MHz | 750mA | 0.058Ω | 6.8GHz |
| LQW15AN7N9C10□ | 7.9nH ±0.2nH | 100MHz | 30 | 250MHz | 640mA | 0.079Ω | 7.5GHz |
| LQW15AN7N9D10□ | 7.9nH ±0.5nH | 100MHz | 30 | 250MHz | 640mA | 0.079Ω | 7.5GHz |
| LQW15AN8N0C10□ | 8.0nH ±0.2nH | 100MHz | 30 | 250MHz | 640mA | 0.079Ω | 7.5GHz |
| LQW15AN8N0D10□ | 8.0nH ±0.5nH | 100MHz | 30 | 250MHz | 640mA | 0.079Ω | 7.5GHz |
| LQW15AN8N1C10□ | 8.1nH ±0.2nH | 100MHz | 30 | 250MHz | 640mA | 0.079Ω | 7.5GHz |
| LQW15AN8N1D10□ | 8.1nH ±0.5nH | 100MHz | 30 | 250MHz | 640mA | 0.079Ω | 7.5GHz |
| LQW15AN8N3C10□ | 8.3nH ±0.2nH | 100MHz | 30 | 250MHz | 640mA | 0.079Ω | 7.5GHz |
| LQW15AN8N3D10□ | 8.3nH ±0.5nH | 100MHz | 30 | 250MHz | 640mA | 0.079Ω | 7.5GHz |
| LQW15AN8N4C10□ | 8.4nH ±0.2nH | 100MHz | 30 | 250MHz | 640mA | 0.079Ω | 7.5GHz |
| LQW15AN8N4D10□ | 8.4nH ±0.5nH | 100MHz | 30 | 250MHz | 640mA | 0.079Ω | 7.5GHz |

Operating temp. range: -55 to 125°C

Only for reflow soldering

*S.R.F.: Self Resonant Frequency

Inductance-Frequency Characteristics (Typ.)



Q-Frequency Characteristics (Typ.)



LQW15AN_80 Series 0402 (1005) inch (mm)



| Packaging Code | Packaging | Minimum Quantity |
|----------------|---------------------|------------------|
| D | ø180mm Paper Taping | 10000 |
| B | Packing in Bulk | 500 |

| Part Number (□: packaging code) | Inductance | Inductance Test Frequency | Q (min.) | Q Test Frequency | Rated Current | Max. of DC Resistance | S.R.F.* (min.) |
|------------------------------------|--------------|---------------------------|----------|------------------|---------------|-----------------------|----------------|
| LQW15AN1N3C80□ | 1.3nH ±0.2nH | 100MHz | 20 | 250MHz | 3150mA | 0.012Ω | 18.0GHz |
| LQW15AN1N3D80□ | 1.3nH ±0.5nH | 100MHz | 20 | 250MHz | 3150mA | 0.012Ω | 18.0GHz |
| LQW15AN1N5C80□ | 1.5nH ±0.2nH | 100MHz | 20 | 250MHz | 2100mA | 0.028Ω | 18.0GHz |
| LQW15AN1N5D80□ | 1.5nH ±0.5nH | 100MHz | 20 | 250MHz | 2100mA | 0.028Ω | 18.0GHz |
| LQW15AN1N6C80□ | 1.6nH ±0.2nH | 100MHz | 20 | 250MHz | 1450mA | 0.045Ω | 18.0GHz |
| LQW15AN1N6D80□ | 1.6nH ±0.5nH | 100MHz | 20 | 250MHz | 1450mA | 0.045Ω | 18.0GHz |
| LQW15AN1N7C80□ | 1.7nH ±0.2nH | 100MHz | 20 | 250MHz | 1150mA | 0.065Ω | 18.0GHz |
| LQW15AN1N7D80□ | 1.7nH ±0.5nH | 100MHz | 20 | 250MHz | 1150mA | 0.065Ω | 18.0GHz |
| LQW15AN2N2B80□ | 2.2nH ±0.1nH | 100MHz | 30 | 250MHz | 2530mA | 0.022Ω | 15.5GHz |
| LQW15AN2N2C80□ | 2.2nH ±0.2nH | 100MHz | 30 | 250MHz | 2530mA | 0.022Ω | 15.5GHz |
| LQW15AN2N2D80□ | 2.2nH ±0.5nH | 100MHz | 30 | 250MHz | 2530mA | 0.022Ω | 15.5GHz |
| LQW15AN2N2G80□ | 2.2nH ±2% | 100MHz | 30 | 250MHz | 2530mA | 0.022Ω | 15.5GHz |
| LQW15AN2N3B80□ | 2.3nH ±0.1nH | 100MHz | 30 | 250MHz | 2530mA | 0.022Ω | 15.5GHz |
| LQW15AN2N3C80□ | 2.3nH ±0.2nH | 100MHz | 30 | 250MHz | 2530mA | 0.022Ω | 15.5GHz |
| LQW15AN2N3D80□ | 2.3nH ±0.5nH | 100MHz | 30 | 250MHz | 2530mA | 0.022Ω | 15.5GHz |
| LQW15AN2N3G80□ | 2.3nH ±2% | 100MHz | 30 | 250MHz | 2530mA | 0.022Ω | 15.5GHz |
| LQW15AN2N4B80□ | 2.4nH ±0.1nH | 100MHz | 30 | 250MHz | 2530mA | 0.022Ω | 15.5GHz |
| LQW15AN2N4C80□ | 2.4nH ±0.2nH | 100MHz | 30 | 250MHz | 2530mA | 0.022Ω | 15.5GHz |
| LQW15AN2N4D80□ | 2.4nH ±0.5nH | 100MHz | 30 | 250MHz | 2530mA | 0.022Ω | 15.5GHz |
| LQW15AN2N4G80□ | 2.4nH ±2% | 100MHz | 30 | 250MHz | 2530mA | 0.022Ω | 15.5GHz |
| LQW15AN2N5B80□ | 2.5nH ±0.1nH | 100MHz | 30 | 250MHz | 2100mA | 0.030Ω | 15.5GHz |
| LQW15AN2N5C80□ | 2.5nH ±0.2nH | 100MHz | 30 | 250MHz | 2100mA | 0.030Ω | 15.5GHz |
| LQW15AN2N5D80□ | 2.5nH ±0.5nH | 100MHz | 30 | 250MHz | 2100mA | 0.030Ω | 15.5GHz |
| LQW15AN2N5G80□ | 2.5nH ±2% | 100MHz | 30 | 250MHz | 2100mA | 0.030Ω | 15.5GHz |
| LQW15AN2N6B80□ | 2.6nH ±0.1nH | 100MHz | 30 | 250MHz | 1950mA | 0.035Ω | 14.5GHz |
| LQW15AN2N6C80□ | 2.6nH ±0.2nH | 100MHz | 30 | 250MHz | 1950mA | 0.035Ω | 14.5GHz |
| LQW15AN2N6D80□ | 2.6nH ±0.5nH | 100MHz | 30 | 250MHz | 1950mA | 0.035Ω | 14.5GHz |
| LQW15AN2N6G80□ | 2.6nH ±2% | 100MHz | 30 | 250MHz | 1950mA | 0.035Ω | 14.5GHz |
| LQW15AN2N7B80□ | 2.7nH ±0.1nH | 100MHz | 28 | 250MHz | 1500mA | 0.047Ω | 14.0GHz |
| LQW15AN2N7C80□ | 2.7nH ±0.2nH | 100MHz | 28 | 250MHz | 1500mA | 0.047Ω | 14.0GHz |
| LQW15AN2N7D80□ | 2.7nH ±0.5nH | 100MHz | 28 | 250MHz | 1500mA | 0.047Ω | 14.0GHz |
| LQW15AN2N7G80□ | 2.7nH ±2% | 100MHz | 28 | 250MHz | 1500mA | 0.047Ω | 14.0GHz |
| LQW15AN2N8B80□ | 2.8nH ±0.1nH | 100MHz | 27 | 250MHz | 1500mA | 0.047Ω | 13.5GHz |
| LQW15AN2N8C80□ | 2.8nH ±0.2nH | 100MHz | 27 | 250MHz | 1500mA | 0.047Ω | 13.5GHz |
| LQW15AN2N8D80□ | 2.8nH ±0.5nH | 100MHz | 27 | 250MHz | 1500mA | 0.047Ω | 13.5GHz |
| LQW15AN2N8G80□ | 2.8nH ±2% | 100MHz | 27 | 250MHz | 1500mA | 0.047Ω | 13.5GHz |
| LQW15AN2N9B80□ | 2.9nH ±0.1nH | 100MHz | 25 | 250MHz | 1500mA | 0.047Ω | 12.5GHz |
| LQW15AN2N9C80□ | 2.9nH ±0.2nH | 100MHz | 25 | 250MHz | 1500mA | 0.047Ω | 12.5GHz |
| LQW15AN2N9D80□ | 2.9nH ±0.5nH | 100MHz | 25 | 250MHz | 1500mA | 0.047Ω | 12.5GHz |

Operating temp. range: -55 to 125°C

Only for reflow soldering

*S.R.F.: Self Resonant Frequency

In operating temperatures exceeding +85°C, derating of current is necessary for the LQW15A_80 series. Please apply the derating curve shown in the chart according to the operating temperature. Please consider "Notice (Rating)."

Continued on the following page. ↗

Continued from the preceding page. ↘

| Part Number (□: packaging code) | Inductance | Inductance Test Frequency | Q (min.) | Q Test Frequency | Rated Current | Max. of DC Resistance | S.R.F.* (min.) |
|------------------------------------|--------------|------------------------------|----------|------------------|---------------|-----------------------|----------------|
| LQW15AN2N9G80□ | 2.9nH ±2% | 100MHz | 25 | 250MHz | 1500mA | 0.047Ω | 12.5GHz |
| LQW15AN3NOB80□ | 3nH ±0.1nH | 100MHz | 20 | 250MHz | 1350mA | 0.063Ω | 12.5GHz |
| LQW15AN3NOC80□ | 3nH ±0.2nH | 100MHz | 20 | 250MHz | 1350mA | 0.063Ω | 12.5GHz |
| LQW15AN3NOD80□ | 3nH ±0.5nH | 100MHz | 20 | 250MHz | 1350mA | 0.063Ω | 12.5GHz |
| LQW15AN3NOG80□ | 3.0nH ±2% | 100MHz | 20 | 250MHz | 1350mA | 0.063Ω | 12.5GHz |
| LQW15AN3N3B80□ | 3.3nH ±0.1nH | 100MHz | 30 | 250MHz | 2000mA | 0.030Ω | 14.0GHz |
| LQW15AN3N3C80□ | 3.3nH ±0.2nH | 100MHz | 30 | 250MHz | 2000mA | 0.030Ω | 14.0GHz |
| LQW15AN3N3D80□ | 3.3nH ±0.5nH | 100MHz | 30 | 250MHz | 2000mA | 0.030Ω | 14.0GHz |
| LQW15AN3N3G80□ | 3.3nH ±2% | 100MHz | 30 | 250MHz | 2000mA | 0.030Ω | 14.0GHz |
| LQW15AN3N4B80□ | 3.4nH ±0.1nH | 100MHz | 30 | 250MHz | 1950mA | 0.030Ω | 10.0GHz |
| LQW15AN3N4C80□ | 3.4nH ±0.2nH | 100MHz | 30 | 250MHz | 1950mA | 0.030Ω | 10.0GHz |
| LQW15AN3N4D80□ | 3.4nH ±0.5nH | 100MHz | 30 | 250MHz | 1950mA | 0.030Ω | 10.0GHz |
| LQW15AN3N4G80□ | 3.4nH ±2% | 100MHz | 30 | 250MHz | 1950mA | 0.030Ω | 10.0GHz |
| LQW15AN3N5B80□ | 3.5nH ±0.1nH | 100MHz | 30 | 250MHz | 1950mA | 0.030Ω | 10.0GHz |
| LQW15AN3N5C80□ | 3.5nH ±0.2nH | 100MHz | 30 | 250MHz | 1950mA | 0.030Ω | 10.0GHz |
| LQW15AN3N5D80□ | 3.5nH ±0.5nH | 100MHz | 30 | 250MHz | 1950mA | 0.030Ω | 10.0GHz |
| LQW15AN3N5G80□ | 3.5nH ±2% | 100MHz | 30 | 250MHz | 1950mA | 0.030Ω | 10.0GHz |
| LQW15AN3N6B80□ | 3.6nH ±0.1nH | 100MHz | 30 | 250MHz | 1950mA | 0.030Ω | 10.0GHz |
| LQW15AN3N6C80□ | 3.6nH ±0.2nH | 100MHz | 30 | 250MHz | 1950mA | 0.030Ω | 10.0GHz |
| LQW15AN3N6D80□ | 3.6nH ±0.5nH | 100MHz | 30 | 250MHz | 1950mA | 0.030Ω | 10.0GHz |
| LQW15AN3N6G80□ | 3.6nH ±2% | 100MHz | 30 | 250MHz | 1950mA | 0.030Ω | 10.0GHz |
| LQW15AN3N7B80□ | 3.7nH ±0.1nH | 100MHz | 35 | 250MHz | 1950mA | 0.030Ω | 10.0GHz |
| LQW15AN3N7C80□ | 3.7nH ±0.2nH | 100MHz | 35 | 250MHz | 1950mA | 0.030Ω | 10.0GHz |
| LQW15AN3N7D80□ | 3.7nH ±0.5nH | 100MHz | 35 | 250MHz | 1950mA | 0.030Ω | 10.0GHz |
| LQW15AN3N7G80□ | 3.7nH ±2% | 100MHz | 35 | 250MHz | 1950mA | 0.030Ω | 10.0GHz |
| LQW15AN3N8B80□ | 3.8nH ±0.1nH | 100MHz | 35 | 250MHz | 1950mA | 0.030Ω | 10.0GHz |
| LQW15AN3N8C80□ | 3.8nH ±0.2nH | 100MHz | 35 | 250MHz | 1950mA | 0.030Ω | 10.0GHz |
| LQW15AN3N8D80□ | 3.8nH ±0.5nH | 100MHz | 35 | 250MHz | 1950mA | 0.030Ω | 10.0GHz |
| LQW15AN3N8G80□ | 3.8nH ±2% | 100MHz | 35 | 250MHz | 1950mA | 0.030Ω | 10.0GHz |
| LQW15AN3N9B80□ | 3.9nH ±0.1nH | 100MHz | 35 | 250MHz | 1950mA | 0.030Ω | 10.0GHz |
| LQW15AN3N9C80□ | 3.9nH ±0.2nH | 100MHz | 35 | 250MHz | 1950mA | 0.030Ω | 10.0GHz |
| LQW15AN3N9D80□ | 3.9nH ±0.5nH | 100MHz | 35 | 250MHz | 1950mA | 0.030Ω | 10.0GHz |
| LQW15AN3N9G80□ | 3.9nH ±2% | 100MHz | 35 | 250MHz | 1950mA | 0.030Ω | 10.0GHz |
| LQW15AN4NOB80□ | 4.0nH ±0.1nH | 100MHz | 30 | 250MHz | 1950mA | 0.030Ω | 10.0GHz |
| LQW15AN4NOC80□ | 4.0nH ±0.2nH | 100MHz | 30 | 250MHz | 1950mA | 0.030Ω | 10.0GHz |
| LQW15AN4NOD80□ | 4.0nH ±0.5nH | 100MHz | 30 | 250MHz | 1950mA | 0.030Ω | 10.0GHz |
| LQW15AN4NOG80□ | 4.0nH ±2% | 100MHz | 30 | 250MHz | 1950mA | 0.030Ω | 10.0GHz |
| LQW15AN4N1B80□ | 4.1nH ±0.1nH | 100MHz | 30 | 250MHz | 1800mA | 0.044Ω | 9.6GHz |
| LQW15AN4N1C80□ | 4.1nH ±0.2nH | 100MHz | 30 | 250MHz | 1800mA | 0.044Ω | 9.6GHz |
| LQW15AN4N1D80□ | 4.1nH ±0.5nH | 100MHz | 30 | 250MHz | 1800mA | 0.044Ω | 9.6GHz |
| LQW15AN4N1G80□ | 4.1nH ±2% | 100MHz | 30 | 250MHz | 1800mA | 0.044Ω | 9.6GHz |
| LQW15AN4N2B80□ | 4.2nH ±0.1nH | 100MHz | 30 | 250MHz | 1800mA | 0.044Ω | 9.6GHz |
| LQW15AN4N2C80□ | 4.2nH ±0.2nH | 100MHz | 30 | 250MHz | 1800mA | 0.044Ω | 9.6GHz |
| LQW15AN4N2D80□ | 4.2nH ±0.5nH | 100MHz | 30 | 250MHz | 1800mA | 0.044Ω | 9.6GHz |
| LQW15AN4N2G80□ | 4.2nH ±2% | 100MHz | 30 | 250MHz | 1800mA | 0.044Ω | 9.6GHz |
| LQW15AN4N3B80□ | 4.3nH ±0.1nH | 100MHz | 32 | 250MHz | 1800mA | 0.044Ω | 9.6GHz |
| LQW15AN4N3C80□ | 4.3nH ±0.2nH | 100MHz | 32 | 250MHz | 1800mA | 0.044Ω | 9.6GHz |
| LQW15AN4N3D80□ | 4.3nH ±0.5nH | 100MHz | 32 | 250MHz | 1800mA | 0.044Ω | 9.6GHz |
| LQW15AN4N3G80□ | 4.3nH ±2% | 100MHz | 32 | 250MHz | 1800mA | 0.044Ω | 9.6GHz |
| LQW15AN4N4B80□ | 4.4nH ±0.1nH | 100MHz | 34 | 250MHz | 1600mA | 0.052Ω | 9.6GHz |
| LQW15AN4N4C80□ | 4.4nH ±0.2nH | 100MHz | 34 | 250MHz | 1600mA | 0.052Ω | 9.6GHz |

Operating temp. range: -55 to 125°C

Only for reflow soldering

*S.R.F.: Self Resonant Frequency

In operating temperatures exceeding +85°C, derating of current is necessary for the LQW15A_80 series. Please apply the derating curve shown in the chart according to the operating temperature. Please consider "Notice (Rating)."

Continued on the following page. ↗

Continued from the preceding page. ↘

| Part Number (□: packaging code) | Inductance | Inductance Test Frequency | Q (min.) | Q Test Frequency | Rated Current | Max. of DC Resistance | S.R.F.* (min.) |
|------------------------------------|--------------|------------------------------|----------|------------------|---------------|-----------------------|----------------|
| LQW15AN4N4D80□ | 4.4nH ±0.5nH | 100MHz | 34 | 250MHz | 1600mA | 0.052Ω | 9.6GHz |
| LQW15AN4N4G80□ | 4.4nH ±2% | 100MHz | 34 | 250MHz | 1600mA | 0.052Ω | 9.6GHz |
| LQW15AN4N5B80□ | 4.5nH ±0.1nH | 100MHz | 34 | 250MHz | 1450mA | 0.060Ω | 9.6GHz |
| LQW15AN4N5C80□ | 4.5nH ±0.2nH | 100MHz | 34 | 250MHz | 1450mA | 0.060Ω | 9.6GHz |
| LQW15AN4N5D80□ | 4.5nH ±0.5nH | 100MHz | 34 | 250MHz | 1450mA | 0.060Ω | 9.6GHz |
| LQW15AN4N5G80□ | 4.5nH ±2% | 100MHz | 34 | 250MHz | 1450mA | 0.060Ω | 9.6GHz |
| LQW15AN4N6B80□ | 4.6nH ±0.1nH | 100MHz | 32 | 250MHz | 1450mA | 0.060Ω | 9.6GHz |
| LQW15AN4N6C80□ | 4.6nH ±0.2nH | 100MHz | 32 | 250MHz | 1450mA | 0.060Ω | 9.6GHz |
| LQW15AN4N6D80□ | 4.6nH ±0.5nH | 100MHz | 32 | 250MHz | 1450mA | 0.060Ω | 9.6GHz |
| LQW15AN4N6G80□ | 4.6nH ±2% | 100MHz | 32 | 250MHz | 1450mA | 0.060Ω | 9.6GHz |
| LQW15AN4N7B80□ | 4.7nH ±0.1nH | 100MHz | 31 | 250MHz | 1200mA | 0.071Ω | 8.0GHz |
| LQW15AN4N7C80□ | 4.7nH ±0.2nH | 100MHz | 31 | 250MHz | 1200mA | 0.071Ω | 8.0GHz |
| LQW15AN4N7D80□ | 4.7nH ±0.5nH | 100MHz | 31 | 250MHz | 1200mA | 0.071Ω | 8.0GHz |
| LQW15AN4N7G80□ | 4.7nH ±2% | 100MHz | 31 | 250MHz | 1200mA | 0.071Ω | 8.0GHz |
| LQW15AN4N8B80□ | 4.8nH ±0.1nH | 100MHz | 30 | 250MHz | 1200mA | 0.071Ω | 8.0GHz |
| LQW15AN4N8C80□ | 4.8nH ±0.2nH | 100MHz | 30 | 250MHz | 1200mA | 0.071Ω | 8.0GHz |
| LQW15AN4N8D80□ | 4.8nH ±0.5nH | 100MHz | 30 | 250MHz | 1200mA | 0.071Ω | 8.0GHz |
| LQW15AN4N8G80□ | 4.8nH ±2% | 100MHz | 30 | 250MHz | 1200mA | 0.071Ω | 8.0GHz |
| LQW15AN4N9B80□ | 4.9nH ±0.1nH | 100MHz | 27 | 250MHz | 1200mA | 0.071Ω | 8.0GHz |
| LQW15AN4N9C80□ | 4.9nH ±0.2nH | 100MHz | 27 | 250MHz | 1200mA | 0.071Ω | 8.0GHz |
| LQW15AN4N9D80□ | 4.9nH ±0.5nH | 100MHz | 27 | 250MHz | 1200mA | 0.071Ω | 8.0GHz |
| LQW15AN4N9G80□ | 4.9nH ±2% | 100MHz | 27 | 250MHz | 1200mA | 0.071Ω | 8.0GHz |
| LQW15AN5N0B80□ | 5.0nH ±0.1nH | 100MHz | 32 | 250MHz | 1770mA | 0.040Ω | 10GHz |
| LQW15AN5N0C80□ | 5.0nH ±0.2nH | 100MHz | 32 | 250MHz | 1770mA | 0.040Ω | 10GHz |
| LQW15AN5N0D80□ | 5.0nH ±0.5nH | 100MHz | 32 | 250MHz | 1770mA | 0.040Ω | 10GHz |
| LQW15AN5N0G80□ | 5.0nH ±2% | 100MHz | 32 | 250MHz | 1770mA | 0.040Ω | 10.0GHz |
| LQW15AN5N1B80□ | 5.1nH ±0.1nH | 100MHz | 35 | 250MHz | 1770mA | 0.040Ω | 8.0GHz |
| LQW15AN5N1C80□ | 5.1nH ±0.2nH | 100MHz | 35 | 250MHz | 1770mA | 0.040Ω | 8.0GHz |
| LQW15AN5N1D80□ | 5.1nH ±0.5nH | 100MHz | 35 | 250MHz | 1770mA | 0.040Ω | 8.0GHz |
| LQW15AN5N1G80□ | 5.1nH ±2% | 100MHz | 35 | 250MHz | 1770mA | 0.040Ω | 8.0GHz |
| LQW15AN5N2B80□ | 5.2nH ±0.1nH | 100MHz | 35 | 250MHz | 1770mA | 0.040Ω | 8.0GHz |
| LQW15AN5N2C80□ | 5.2nH ±0.2nH | 100MHz | 35 | 250MHz | 1770mA | 0.040Ω | 8.0GHz |
| LQW15AN5N2D80□ | 5.2nH ±0.5nH | 100MHz | 35 | 250MHz | 1770mA | 0.040Ω | 8.0GHz |
| LQW15AN5N2G80□ | 5.2nH ±2% | 100MHz | 35 | 250MHz | 1770mA | 0.040Ω | 8.0GHz |
| LQW15AN5N3B80□ | 5.3nH ±0.1nH | 100MHz | 35 | 250MHz | 1770mA | 0.040Ω | 8.0GHz |
| LQW15AN5N3C80□ | 5.3nH ±0.2nH | 100MHz | 35 | 250MHz | 1770mA | 0.040Ω | 8.0GHz |
| LQW15AN5N3D80□ | 5.3nH ±0.5nH | 100MHz | 35 | 250MHz | 1770mA | 0.040Ω | 8.0GHz |
| LQW15AN5N3G80□ | 5.3nH ±2% | 100MHz | 35 | 250MHz | 1770mA | 0.040Ω | 8.0GHz |
| LQW15AN5N4B80□ | 5.4nH ±0.1nH | 100MHz | 35 | 250MHz | 1770mA | 0.040Ω | 8.0GHz |
| LQW15AN5N4C80□ | 5.4nH ±0.2nH | 100MHz | 35 | 250MHz | 1770mA | 0.040Ω | 8.0GHz |
| LQW15AN5N4D80□ | 5.4nH ±0.5nH | 100MHz | 35 | 250MHz | 1770mA | 0.040Ω | 8.0GHz |
| LQW15AN5N4G80□ | 5.4nH ±2% | 100MHz | 35 | 250MHz | 1770mA | 0.040Ω | 8.0GHz |
| LQW15AN5N5B80□ | 5.5nH ±0.1nH | 100MHz | 35 | 250MHz | 1770mA | 0.040Ω | 8.0GHz |
| LQW15AN5N5C80□ | 5.5nH ±0.2nH | 100MHz | 35 | 250MHz | 1770mA | 0.040Ω | 8.0GHz |
| LQW15AN5N5D80□ | 5.5nH ±0.5nH | 100MHz | 35 | 250MHz | 1770mA | 0.040Ω | 8.0GHz |
| LQW15AN5N5G80□ | 5.5nH ±2% | 100MHz | 35 | 250MHz | 1770mA | 0.040Ω | 8.0GHz |
| LQW15AN5N6B80□ | 5.6nH ±0.1nH | 100MHz | 35 | 250MHz | 1770mA | 0.040Ω | 8.0GHz |
| LQW15AN5N6C80□ | 5.6nH ±0.2nH | 100MHz | 35 | 250MHz | 1770mA | 0.040Ω | 8.0GHz |
| LQW15AN5N6D80□ | 5.6nH ±0.5nH | 100MHz | 35 | 250MHz | 1770mA | 0.040Ω | 8.0GHz |
| LQW15AN5N6G80□ | 5.6nH ±2% | 100MHz | 35 | 250MHz | 1770mA | 0.040Ω | 8.0GHz |
| LQW15AN5N7B80□ | 5.7nH ±0.1nH | 100MHz | 30 | 250MHz | 1770mA | 0.040Ω | 8.0GHz |

Operating temp. range: -55 to 125°C

Only for reflow soldering

*S.R.F.: Self Resonant Frequency

In operating temperatures exceeding +85°C, derating of current is necessary for the LQW15A_80 series. Please apply the derating curve shown in the chart according to the operating temperature. Please consider "Notice (Rating)."

Continued on the following page. ↗

Continued from the preceding page. ↘

| Part Number (□: packaging code) | Inductance | Inductance Test Frequency | Q (min.) | Q Test Frequency | Rated Current | Max. of DC Resistance | S.R.F.* (min.) |
|------------------------------------|--------------|------------------------------|----------|------------------|---------------|-----------------------|----------------|
| LQW15AN5N7C80□ | 5.7nH ±0.2nH | 100MHz | 30 | 250MHz | 1770mA | 0.040Ω | 8.0GHz |
| LQW15AN5N7D80□ | 5.7nH ±0.5nH | 100MHz | 30 | 250MHz | 1770mA | 0.040Ω | 8.0GHz |
| LQW15AN5N7G80□ | 5.7nH ±2% | 100MHz | 30 | 250MHz | 1770mA | 0.040Ω | 8.0GHz |
| LQW15AN5N8B80□ | 5.8nH ±0.1nH | 100MHz | 30 | 250MHz | 1770mA | 0.040Ω | 8.0GHz |
| LQW15AN5N8C80□ | 5.8nH ±0.2nH | 100MHz | 30 | 250MHz | 1770mA | 0.040Ω | 8.0GHz |
| LQW15AN5N8D80□ | 5.8nH ±0.5nH | 100MHz | 30 | 250MHz | 1770mA | 0.040Ω | 8.0GHz |
| LQW15AN5N8G80□ | 5.8nH ±2% | 100MHz | 30 | 250MHz | 1770mA | 0.040Ω | 8.0GHz |
| LQW15AN5N9B80□ | 5.9nH ±0.1nH | 100MHz | 30 | 250MHz | 1770mA | 0.040Ω | 8.0GHz |
| LQW15AN5N9C80□ | 5.9nH ±0.2nH | 100MHz | 30 | 250MHz | 1770mA | 0.040Ω | 8.0GHz |
| LQW15AN5N9D80□ | 5.9nH ±0.5nH | 100MHz | 30 | 250MHz | 1770mA | 0.040Ω | 8.0GHz |
| LQW15AN5N9G80□ | 5.9nH ±2% | 100MHz | 30 | 250MHz | 1770mA | 0.040Ω | 8.0GHz |
| LQW15AN6NOB80□ | 6.0nH ±0.1nH | 100MHz | 32 | 250MHz | 1600mA | 0.056Ω | 8.0GHz |
| LQW15AN6NOC80□ | 6.0nH ±0.2nH | 100MHz | 32 | 250MHz | 1600mA | 0.056Ω | 8.0GHz |
| LQW15AN6NOD80□ | 6.0nH ±0.5nH | 100MHz | 32 | 250MHz | 1600mA | 0.056Ω | 8.0GHz |
| LQW15AN6NOG80□ | 6.0nH ±2% | 100MHz | 32 | 250MHz | 1600mA | 0.056Ω | 8.0GHz |
| LQW15AN6N1B80□ | 6.1nH ±0.1nH | 100MHz | 32 | 250MHz | 1600mA | 0.056Ω | 8.0GHz |
| LQW15AN6N1C80□ | 6.1nH ±0.2nH | 100MHz | 32 | 250MHz | 1600mA | 0.056Ω | 8.0GHz |
| LQW15AN6N1D80□ | 6.1nH ±0.5nH | 100MHz | 32 | 250MHz | 1600mA | 0.056Ω | 8.0GHz |
| LQW15AN6N1G80□ | 6.1nH ±2% | 100MHz | 32 | 250MHz | 1600mA | 0.056Ω | 8.0GHz |
| LQW15AN6N2B80□ | 6.2nH ±0.1nH | 100MHz | 33 | 250MHz | 1600mA | 0.056Ω | 8.0GHz |
| LQW15AN6N2C80□ | 6.2nH ±0.2nH | 100MHz | 33 | 250MHz | 1600mA | 0.056Ω | 8.0GHz |
| LQW15AN6N2D80□ | 6.2nH ±0.5nH | 100MHz | 33 | 250MHz | 1600mA | 0.056Ω | 8.0GHz |
| LQW15AN6N2G80□ | 6.2nH ±2% | 100MHz | 33 | 250MHz | 1600mA | 0.056Ω | 8.0GHz |
| LQW15AN6N3G80□ | 6.3nH ±2% | 100MHz | 32 | 250MHz | 1600mA | 0.057Ω | 7.8GHz |
| LQW15AN6N3J80□ | 6.3nH ±5% | 100MHz | 32 | 250MHz | 1600mA | 0.057Ω | 7.8GHz |
| LQW15AN6N4G80□ | 6.4nH ±2% | 100MHz | 33 | 250MHz | 1380mA | 0.065Ω | 7.0GHz |
| LQW15AN6N4J80□ | 6.4nH ±5% | 100MHz | 33 | 250MHz | 1380mA | 0.065Ω | 7.0GHz |
| LQW15AN6N5G80□ | 6.5nH ±2% | 100MHz | 32 | 250MHz | 1380mA | 0.065Ω | 7.0GHz |
| LQW15AN6N5J80□ | 6.5nH ±5% | 100MHz | 32 | 250MHz | 1380mA | 0.065Ω | 7.0GHz |
| LQW15AN6N6G80□ | 6.6nH ±2% | 100MHz | 30 | 250MHz | 1280mA | 0.078Ω | 7.0GHz |
| LQW15AN6N6J80□ | 6.6nH ±5% | 100MHz | 30 | 250MHz | 1280mA | 0.078Ω | 7.0GHz |
| LQW15AN6N7G80□ | 6.7nH ±2% | 100MHz | 30 | 250MHz | 1280mA | 0.078Ω | 7.0GHz |
| LQW15AN6N7J80□ | 6.7nH ±5% | 100MHz | 30 | 250MHz | 1280mA | 0.078Ω | 7.0GHz |
| LQW15AN6N8G80□ | 6.8nH ±2% | 100MHz | 30 | 250MHz | 1450mA | 0.068Ω | 7.0GHz |
| LQW15AN6N8J80□ | 6.8nH ±5% | 100MHz | 30 | 250MHz | 1450mA | 0.068Ω | 7.0GHz |
| LQW15AN6N9G80□ | 6.9nH ±2% | 100MHz | 32 | 250MHz | 1420mA | 0.069Ω | 8.5GHz |
| LQW15AN6N9J80□ | 6.9nH ±5% | 100MHz | 32 | 250MHz | 1420mA | 0.069Ω | 8.5GHz |
| LQW15AN7NOG80□ | 7.0nH ±2% | 100MHz | 33 | 250MHz | 1420mA | 0.069Ω | 8.0GHz |
| LQW15AN7NOJ80□ | 7.0nH ±5% | 100MHz | 33 | 250MHz | 1420mA | 0.069Ω | 8.0GHz |
| LQW15AN7N1G80□ | 7.1nH ±2% | 100MHz | 32 | 250MHz | 1420mA | 0.069Ω | 7.0GHz |
| LQW15AN7N1J80□ | 7.1nH ±5% | 100MHz | 32 | 250MHz | 1420mA | 0.069Ω | 7.0GHz |
| LQW15AN7N2G80□ | 7.2nH ±2% | 100MHz | 32 | 250MHz | 1700mA | 0.050Ω | 7.0GHz |
| LQW15AN7N2J80□ | 7.2nH ±5% | 100MHz | 32 | 250MHz | 1700mA | 0.050Ω | 7.0GHz |
| LQW15AN7N3G80□ | 7.3nH ±2% | 100MHz | 32 | 250MHz | 1700mA | 0.050Ω | 7.0GHz |
| LQW15AN7N3J80□ | 7.3nH ±5% | 100MHz | 32 | 250MHz | 1700mA | 0.050Ω | 7.0GHz |
| LQW15AN7N4G80□ | 7.4nH ±2% | 100MHz | 30 | 250MHz | 1700mA | 0.050Ω | 7.0GHz |
| LQW15AN7N4J80□ | 7.4nH ±5% | 100MHz | 30 | 250MHz | 1700mA | 0.050Ω | 7.0GHz |
| LQW15AN7N5G80□ | 7.5nH ±2% | 100MHz | 35 | 250MHz | 1700mA | 0.050Ω | 7.0GHz |
| LQW15AN7N5J80□ | 7.5nH ±5% | 100MHz | 35 | 250MHz | 1700mA | 0.050Ω | 7.0GHz |
| LQW15AN7N6G80□ | 7.6nH ±2% | 100MHz | 30 | 250MHz | 1700mA | 0.050Ω | 7.0GHz |
| LQW15AN7N6J80□ | 7.6nH ±5% | 100MHz | 30 | 250MHz | 1700mA | 0.050Ω | 7.0GHz |

Operating temp. range: -55 to 125°C

Only for reflow soldering

*S.R.F.: Self Resonant Frequency

In operating temperatures exceeding +85°C, derating of current is necessary for the LQW15A_80 series. Please apply the derating curve shown in the chart according to the operating temperature. Please consider "Notice (Rating)."

Continued on the following page. ↗

Continued from the preceding page. ↘

| Part Number (□: packaging code) | Inductance | Inductance Test Frequency | Q (min.) | Q Test Frequency | Rated Current | Max. of DC Resistance | S.R.F.* (min.) |
|------------------------------------|------------|------------------------------|----------|------------------|---------------|-----------------------|----------------|
| LQW15AN7N7G80□ | 7.7nH ±2% | 100MHz | 30 | 250MHz | 1700mA | 0.050Ω | 7.0GHz |
| LQW15AN7N7J80□ | 7.7nH ±5% | 100MHz | 30 | 250MHz | 1700mA | 0.050Ω | 7.0GHz |
| LQW15AN7N8G80□ | 7.8nH ±2% | 100MHz | 30 | 250MHz | 1700mA | 0.050Ω | 7.0GHz |
| LQW15AN7N8J80□ | 7.8nH ±5% | 100MHz | 30 | 250MHz | 1700mA | 0.050Ω | 7.0GHz |
| LQW15AN7N9G80□ | 7.9nH ±2% | 100MHz | 30 | 250MHz | 1700mA | 0.050Ω | 7.0GHz |
| LQW15AN7N9J80□ | 7.9nH ±5% | 100MHz | 30 | 250MHz | 1700mA | 0.050Ω | 7.0GHz |
| LQW15AN8N0G80□ | 8.0nH ±2% | 100MHz | 30 | 250MHz | 1700mA | 0.050Ω | 7.0GHz |
| LQW15AN8N0J80□ | 8.0nH ±5% | 100MHz | 30 | 250MHz | 1700mA | 0.050Ω | 7.0GHz |
| LQW15AN8N1G80□ | 8.1nH ±2% | 100MHz | 32 | 250MHz | 1500mA | 0.069Ω | 6.5GHz |
| LQW15AN8N1J80□ | 8.1nH ±5% | 100MHz | 32 | 250MHz | 1500mA | 0.069Ω | 6.5GHz |
| LQW15AN8N2G80□ | 8.2nH ±2% | 100MHz | 32 | 250MHz | 1500mA | 0.069Ω | 6.5GHz |
| LQW15AN8N2J80□ | 8.2nH ±5% | 100MHz | 32 | 250MHz | 1500mA | 0.069Ω | 6.5GHz |
| LQW15AN8N3G80□ | 8.3nH ±2% | 100MHz | 32 | 250MHz | 1500mA | 0.069Ω | 6.5GHz |
| LQW15AN8N3J80□ | 8.3nH ±5% | 100MHz | 32 | 250MHz | 1500mA | 0.069Ω | 6.5GHz |
| LQW15AN8N4G80□ | 8.4nH ±2% | 100MHz | 32 | 250MHz | 1500mA | 0.069Ω | 6.5GHz |
| LQW15AN8N4J80□ | 8.4nH ±5% | 100MHz | 32 | 250MHz | 1500mA | 0.069Ω | 6.5GHz |
| LQW15AN8N5G80□ | 8.5nH ±2% | 100MHz | 32 | 250MHz | 1500mA | 0.069Ω | 6.5GHz |
| LQW15AN8N5J80□ | 8.5nH ±5% | 100MHz | 32 | 250MHz | 1500mA | 0.069Ω | 6.5GHz |
| LQW15AN8N6G80□ | 8.6nH ±2% | 100MHz | 31 | 250MHz | 1420mA | 0.070Ω | 6.5GHz |
| LQW15AN8N6J80□ | 8.6nH ±5% | 100MHz | 31 | 250MHz | 1420mA | 0.070Ω | 6.5GHz |
| LQW15AN8N7G80□ | 8.7nH ±2% | 100MHz | 31 | 250MHz | 1420mA | 0.070Ω | 6.5GHz |
| LQW15AN8N7J80□ | 8.7nH ±5% | 100MHz | 31 | 250MHz | 1420mA | 0.070Ω | 6.5GHz |
| LQW15AN8N8G80□ | 8.8nH ±2% | 100MHz | 31 | 250MHz | 1420mA | 0.070Ω | 6.5GHz |
| LQW15AN8N8J80□ | 8.8nH ±5% | 100MHz | 31 | 250MHz | 1420mA | 0.070Ω | 6.5GHz |
| LQW15AN8N9G80□ | 8.9nH ±2% | 100MHz | 31 | 250MHz | 1420mA | 0.070Ω | 6.5GHz |
| LQW15AN8N9J80□ | 8.9nH ±5% | 100MHz | 31 | 250MHz | 1420mA | 0.070Ω | 6.5GHz |
| LQW15AN9N0G80□ | 9nH ±2% | 100MHz | 30 | 250MHz | 1420mA | 0.070Ω | 6.5GHz |
| LQW15AN9N0J80□ | 9nH ±5% | 100MHz | 30 | 250MHz | 1420mA | 0.070Ω | 6.5GHz |
| LQW15AN9N1G80□ | 9.1nH ±2% | 100MHz | 32 | 250MHz | 1400mA | 0.080Ω | 6.5GHz |
| LQW15AN9N1J80□ | 9.1nH ±5% | 100MHz | 32 | 250MHz | 1400mA | 0.080Ω | 6.5GHz |
| LQW15AN9N2G80□ | 9.2nH ±2% | 100MHz | 32 | 250MHz | 1400mA | 0.081Ω | 6.0GHz |
| LQW15AN9N2J80□ | 9.2nH ±5% | 100MHz | 32 | 250MHz | 1400mA | 0.081Ω | 6.0GHz |
| LQW15AN9N3G80□ | 9.3nH ±2% | 100MHz | 34 | 250MHz | 1400mA | 0.081Ω | 6.0GHz |
| LQW15AN9N3J80□ | 9.3nH ±5% | 100MHz | 34 | 250MHz | 1400mA | 0.081Ω | 6.0GHz |
| LQW15AN9N4G80□ | 9.4nH ±2% | 100MHz | 33 | 250MHz | 1400mA | 0.081Ω | 6.0GHz |
| LQW15AN9N4J80□ | 9.4nH ±5% | 100MHz | 33 | 250MHz | 1400mA | 0.081Ω | 6.0GHz |
| LQW15AN9N5G80□ | 9.5nH ±2% | 100MHz | 32 | 250MHz | 1400mA | 0.081Ω | 6.0GHz |
| LQW15AN9N5J80□ | 9.5nH ±5% | 100MHz | 32 | 250MHz | 1400mA | 0.081Ω | 6.0GHz |
| LQW15AN9N6G80□ | 9.6nH ±2% | 100MHz | 33 | 250MHz | 1400mA | 0.081Ω | 6.0GHz |
| LQW15AN9N6J80□ | 9.6nH ±5% | 100MHz | 33 | 250MHz | 1400mA | 0.081Ω | 6.0GHz |
| LQW15AN9N7G80□ | 9.7nH ±2% | 100MHz | 33 | 250MHz | 1400mA | 0.081Ω | 6.0GHz |
| LQW15AN9N7J80□ | 9.7nH ±5% | 100MHz | 33 | 250MHz | 1400mA | 0.081Ω | 6.0GHz |
| LQW15AN9N8G80□ | 9.8nH ±2% | 100MHz | 34 | 250MHz | 1400mA | 0.081Ω | 6.0GHz |
| LQW15AN9N8J80□ | 9.8nH ±5% | 100MHz | 34 | 250MHz | 1400mA | 0.081Ω | 6.0GHz |
| LQW15AN9N9G80□ | 9.9nH ±2% | 100MHz | 32 | 250MHz | 1400mA | 0.081Ω | 6.0GHz |
| LQW15AN9N9J80□ | 9.9nH ±5% | 100MHz | 32 | 250MHz | 1400mA | 0.081Ω | 6.0GHz |
| LQW15AN10NG80□ | 10nH ±2% | 100MHz | 31 | 250MHz | 1400mA | 0.081Ω | 6.0GHz |
| LQW15AN10NJ80□ | 10nH ±5% | 100MHz | 31 | 250MHz | 1400mA | 0.081Ω | 6.0GHz |
| LQW15AN11NG80□ | 11nH ±2% | 100MHz | 32 | 250MHz | 1400mA | 0.083Ω | 6.2GHz |
| LQW15AN11NJ80□ | 11nH ±5% | 100MHz | 32 | 250MHz | 1400mA | 0.083Ω | 6.2GHz |
| LQW15AN12NG80□ | 12nH ±2% | 100MHz | 30 | 250MHz | 1240mA | 0.093Ω | 5.2GHz |

Operating temp. range: -55 to 125°C

Only for reflow soldering

*S.R.F.: Self Resonant Frequency

In operating temperatures exceeding +85°C, derating of current is necessary for the LQW15A_80 series. Please apply the derating curve shown in the chart according to the operating temperature. Please consider "Notice (Rating)."

Continued on the following page. ↗

Continued from the preceding page. ↘

| Part Number (□: packaging code) | Inductance | Inductance Test Frequency | Q (min.) | Q Test Frequency | Rated Current | Max. of DC Resistance | S.R.F.* (min.) |
|------------------------------------|------------|------------------------------|----------|------------------|---------------|-----------------------|----------------|
| LQW15AN12NJ80□ | 12nH ±5% | 100MHz | 30 | 250MHz | 1240mA | 0.093Ω | 5.2GHz |
| LQW15AN13NG80□ | 13nH ±2% | 100MHz | 30 | 250MHz | 1240mA | 0.093Ω | 5.2GHz |
| LQW15AN13NJ80□ | 13nH ±5% | 100MHz | 30 | 250MHz | 1240mA | 0.093Ω | 5.2GHz |
| LQW15AN14NG80□ | 14nH ±2% | 100MHz | 31 | 250MHz | 1150mA | 0.111Ω | 5.2GHz |
| LQW15AN14NJ80□ | 14nH ±5% | 100MHz | 31 | 250MHz | 1150mA | 0.111Ω | 5.2GHz |
| LQW15AN15NG80□ | 15nH ±2% | 100MHz | 31 | 250MHz | 1150mA | 0.114Ω | 5.5GHz |
| LQW15AN15NJ80□ | 15nH ±5% | 100MHz | 31 | 250MHz | 1150mA | 0.114Ω | 5.5GHz |
| LQW15AN16NG80□ | 16nH ±2% | 100MHz | 31 | 250MHz | 1000mA | 0.126Ω | 5.0GHz |
| LQW15AN16NJ80□ | 16nH ±5% | 100MHz | 31 | 250MHz | 1000mA | 0.126Ω | 5.0GHz |
| LQW15AN17NG80□ | 17nH ±2% | 100MHz | 30 | 250MHz | 1000mA | 0.126Ω | 5.0GHz |
| LQW15AN17NJ80□ | 17nH ±5% | 100MHz | 30 | 250MHz | 1000mA | 0.126Ω | 5.0GHz |
| LQW15AN18NG80□ | 18nH ±2% | 100MHz | 30 | 250MHz | 1050mA | 0.130Ω | 5.2GHz |
| LQW15AN18NJ80□ | 18nH ±5% | 100MHz | 30 | 250MHz | 1050mA | 0.130Ω | 5.2GHz |
| LQW15AN19NG80□ | 19nH ±2% | 100MHz | 30 | 250MHz | 920mA | 0.156Ω | 5.0GHz |
| LQW15AN19NJ80□ | 19nH ±5% | 100MHz | 30 | 250MHz | 920mA | 0.156Ω | 5.0GHz |
| LQW15AN20NG80□ | 20nH ±2% | 100MHz | 30 | 250MHz | 800mA | 0.186Ω | 4.5GHz |
| LQW15AN20NJ80□ | 20nH ±5% | 100MHz | 30 | 250MHz | 800mA | 0.186Ω | 4.5GHz |
| LQW15AN21NG80□ | 21nH ±2% | 100MHz | 30 | 250MHz | 780mA | 0.202Ω | 4.5GHz |
| LQW15AN21NJ80□ | 21nH ±5% | 100MHz | 30 | 250MHz | 780mA | 0.202Ω | 4.5GHz |
| LQW15AN22NG80□ | 22nH ±2% | 100MHz | 30 | 250MHz | 780mA | 0.202Ω | 4.5GHz |
| LQW15AN22NJ80□ | 22nH ±5% | 100MHz | 30 | 250MHz | 780mA | 0.202Ω | 4.5GHz |
| LQW15AN23NG80□ | 23nH ±2% | 100MHz | 29 | 250MHz | 760mA | 0.201Ω | 4.5GHz |
| LQW15AN23NJ80□ | 23nH ±5% | 100MHz | 29 | 250MHz | 760mA | 0.201Ω | 4.5GHz |
| LQW15AN24NG80□ | 24nH ±2% | 100MHz | 31 | 250MHz | 770mA | 0.212Ω | 4.0GHz |
| LQW15AN24NJ80□ | 24nH ±5% | 100MHz | 31 | 250MHz | 770mA | 0.212Ω | 4.0GHz |
| LQW15AN25NG80□ | 25nH ±2% | 100MHz | 31 | 250MHz | 750mA | 0.221Ω | 4.1GHz |
| LQW15AN25NJ80□ | 25nH ±5% | 100MHz | 31 | 250MHz | 750mA | 0.221Ω | 4.1GHz |
| LQW15AN26NG80□ | 26nH ±2% | 100MHz | 29 | 250MHz | 720mA | 0.282Ω | 4.1GHz |
| LQW15AN26NJ80□ | 26nH ±5% | 100MHz | 29 | 250MHz | 720mA | 0.282Ω | 4.1GHz |
| LQW15AN27NG80□ | 27nH ±2% | 100MHz | 30 | 250MHz | 680mA | 0.288Ω | 4.0GHz |
| LQW15AN27NJ80□ | 27nH ±5% | 100MHz | 30 | 250MHz | 680mA | 0.288Ω | 4.0GHz |
| LQW15AN30NG80□ | 30nH ±2% | 100MHz | 30 | 250MHz | 660mA | 0.309Ω | 3.8GHz |
| LQW15AN30NJ80□ | 30nH ±5% | 100MHz | 30 | 250MHz | 660mA | 0.309Ω | 3.8GHz |
| LQW15AN33NG80□ | 33nH ±2% | 100MHz | 30 | 250MHz | 620mA | 0.336Ω | 3.6GHz |
| LQW15AN33NJ80□ | 33nH ±5% | 100MHz | 30 | 250MHz | 620mA | 0.336Ω | 3.6GHz |
| LQW15AN36NG80□ | 36nH ±2% | 100MHz | 30 | 250MHz | 540mA | 0.431Ω | 3.5GHz |
| LQW15AN36NJ80□ | 36nH ±5% | 100MHz | 30 | 250MHz | 540mA | 0.431Ω | 3.5GHz |
| LQW15AN39NG80□ | 39nH ±2% | 100MHz | 28 | 250MHz | 530mA | 0.456Ω | 3.4GHz |
| LQW15AN39NJ80□ | 39nH ±5% | 100MHz | 28 | 250MHz | 530mA | 0.456Ω | 3.4GHz |
| LQW15AN43NG80□ | 43nH ±2% | 100MHz | 30 | 250MHz | 515mA | 0.516Ω | 3.4GHz |
| LQW15AN43NJ80□ | 43nH ±5% | 100MHz | 30 | 250MHz | 515mA | 0.516Ω | 3.4GHz |
| LQW15AN47NG80□ | 47nH ±2% | 100MHz | 25 | 200MHz | 440mA | 0.648Ω | 3.2GHz |
| LQW15AN47NJ80□ | 47nH ±5% | 100MHz | 25 | 200MHz | 440mA | 0.648Ω | 3.2GHz |
| LQW15AN51NG80□ | 51nH ±2% | 100MHz | 25 | 200MHz | 415mA | 0.696Ω | 2.9GHz |
| LQW15AN51NJ80□ | 51nH ±5% | 100MHz | 25 | 200MHz | 415mA | 0.696Ω | 2.9GHz |
| LQW15AN53NG80□ | 53nH ±2% | 100MHz | 25 | 200MHz | 415mA | 0.696Ω | 2.9GHz |
| LQW15AN53NJ80□ | 53nH ±5% | 100MHz | 25 | 200MHz | 415mA | 0.696Ω | 2.9GHz |
| LQW15AN56NG80□ | 56nH ±2% | 100MHz | 25 | 200MHz | 340mA | 0.996Ω | 2.9GHz |
| LQW15AN56NJ80□ | 56nH ±5% | 100MHz | 25 | 200MHz | 340mA | 0.996Ω | 2.9GHz |
| LQW15AN68NG80□ | 68nH ±2% | 100MHz | 25 | 200MHz | 320mA | 1.128Ω | 2.5GHz |
| LQW15AN68NJ80□ | 68nH ±5% | 100MHz | 25 | 200MHz | 320mA | 1.128Ω | 2.5GHz |

Operating temp. range: -55 to 125°C

Only for reflow soldering

*S.R.F.: Self Resonant Frequency

In operating temperatures exceeding +85°C, derating of current is necessary for the LQW15A_80 series. Please apply the derating curve shown in the chart according to the operating temperature. Please consider "Notice (Rating)."

Continued on the following page. ↗

Continued from the preceding page. ↘

| Part Number (□: packaging code) | Inductance | Inductance Test Frequency | Q (min.) | Q Test Frequency | Rated Current | Max. of DC Resistance | S.R.F.* (min.) |
|------------------------------------|------------|------------------------------|----------|------------------|---------------|-----------------------|----------------|
| LQW15AN75NG80□ | 75nH ±2% | 100MHz | 25 | 200MHz | 320mA | 1.224Ω | 2.4GHz |
| LQW15AN75NJ80□ | 75nH ±5% | 100MHz | 25 | 200MHz | 320mA | 1.224Ω | 2.4GHz |

Operating temp. range: -55 to 125°C

Only for reflow soldering

*S.R.F.: Self Resonant Frequency

In operating temperatures exceeding +85°C, derating of current is necessary for the LQW15A_80 series. Please apply the derating curve shown in the chart according to the operating temperature. Please consider "Notice (Rating)."

Inductance-Frequency Characteristics (Typ.)



Q-Frequency Characteristics (Typ.)



Notice (Rating)

In operating temperatures exceeding +85°C, derating of current is necessary for this series. Please apply the derating curve shown in the chart according to the operating temperature.

Derating of Rated Current



LQW15AW_80 Series 0402 (1005) inch (mm)



| Packaging Code | Packaging | Minimum Quantity |
|----------------|---------------------|------------------|
| D | ø180mm Paper Taping | 10000 |
| B | Packing in Bulk | 500 |

| Part Number (□: packaging code) | Inductance | Inductance Test Frequency | Q (min.) | Q Test Frequency | Rated Current | Max. of DC Resistance | S.R.F.* (min.) |
|------------------------------------|------------|------------------------------|----------|------------------|---------------|-----------------------|----------------|
| LQW15AW51NG80□ | 51nH ±2% | 250MHz | 33 | 250MHz | 480mA | 0.47Ω | 2.1GHz |
| LQW15AW51NH80□ | 51nH ±3% | 250MHz | 33 | 250MHz | 480mA | 0.47Ω | 2.1GHz |
| LQW15AW51NJ80□ | 51nH ±5% | 250MHz | 33 | 250MHz | 480mA | 0.47Ω | 2.1GHz |
| LQW15AW53NG80□ | 53nH ±2% | 250MHz | 33 | 250MHz | 480mA | 0.47Ω | 2.1GHz |
| LQW15AW53NH80□ | 53nH ±3% | 250MHz | 33 | 250MHz | 480mA | 0.47Ω | 2.1GHz |
| LQW15AW53NJ80□ | 53nH ±5% | 250MHz | 33 | 250MHz | 480mA | 0.47Ω | 2.1GHz |
| LQW15AW56NG80□ | 56nH ±2% | 250MHz | 33 | 250MHz | 480mA | 0.52Ω | 2.1GHz |
| LQW15AW56NH80□ | 56nH ±3% | 250MHz | 33 | 250MHz | 480mA | 0.52Ω | 2.1GHz |
| LQW15AW56NJ80□ | 56nH ±5% | 250MHz | 33 | 250MHz | 480mA | 0.52Ω | 2.1GHz |
| LQW15AW68NG80□ | 68nH ±2% | 250MHz | 33 | 250MHz | 480mA | 0.56Ω | 1.8GHz |
| LQW15AW68NH80□ | 68nH ±3% | 250MHz | 33 | 250MHz | 480mA | 0.56Ω | 1.8GHz |
| LQW15AW68NJ80□ | 68nH ±5% | 250MHz | 33 | 250MHz | 480mA | 0.56Ω | 1.8GHz |
| LQW15AW75NG80□ | 75nH ±2% | 250MHz | 33 | 250MHz | 450mA | 0.61Ω | 1.8GHz |
| LQW15AW75NH80□ | 75nH ±3% | 250MHz | 33 | 250MHz | 450mA | 0.61Ω | 1.8GHz |
| LQW15AW75NJ80□ | 75nH ±5% | 250MHz | 33 | 250MHz | 450mA | 0.61Ω | 1.8GHz |

Operating temp. range (Self-temp. rise included): -40 to 140°C

Only for reflow soldering

*S.R.F.: Self Resonant Frequency

In operating temperatures exceeding +85°C, derating of current is necessary for the LQW15A_80 series. Please apply the derating curve shown in the chart according to the operating temperature. Please consider "Notice (Rating)."

Continued on the following page. ↗

Continued from the preceding page. ↘

| Part Number (□: packaging code) | Inductance | Inductance Test Frequency | Q (min.) | Q Test Frequency | Rated Current | Max. of DC Resistance | S.R.F.* (min.) |
|------------------------------------|------------|---------------------------|----------|------------------|---------------|-----------------------|----------------|
| LQW15AW82NG80□ | 82nH ±2% | 250MHz | 33 | 250MHz | 370mA | 0.87Ω | 1.7GHz |
| LQW15AW82NH80□ | 82nH ±3% | 250MHz | 33 | 250MHz | 370mA | 0.87Ω | 1.7GHz |
| LQW15AW82NJ80□ | 82nH ±5% | 250MHz | 33 | 250MHz | 370mA | 0.87Ω | 1.7GHz |
| LQW15AWR10G80□ | 100nH ±2% | 250MHz | 33 | 250MHz | 350mA | 1Ω | 1.6GHz |
| LQW15AWR10H80□ | 100nH ±3% | 250MHz | 33 | 250MHz | 350mA | 1Ω | 1.6GHz |
| LQW15AWR10J80□ | 100nH ±5% | 250MHz | 33 | 250MHz | 350mA | 1Ω | 1.6GHz |
| LQW15AWR12G80□ | 120nH ±2% | 250MHz | 33 | 250MHz | 320mA | 1.2Ω | 1.4GHz |
| LQW15AWR12H80□ | 120nH ±3% | 250MHz | 33 | 250MHz | 320mA | 1.2Ω | 1.4GHz |
| LQW15AWR12J80□ | 120nH ±5% | 250MHz | 33 | 250MHz | 320mA | 1.2Ω | 1.4GHz |
| LQW15AWR15G80□ | 150nH ±2% | 100MHz | 33 | 250MHz | 280mA | 1.71Ω | 1.4GHz |
| LQW15AWR15H80□ | 150nH ±3% | 100MHz | 33 | 250MHz | 280mA | 1.71Ω | 1.4GHz |
| LQW15AWR15J80□ | 150nH ±5% | 100MHz | 33 | 250MHz | 280mA | 1.71Ω | 1.4GHz |
| LQW15AWR16G80□ | 160nH ±2% | 100MHz | 33 | 250MHz | 280mA | 1.86Ω | 1.3GHz |
| LQW15AWR16H80□ | 160nH ±3% | 100MHz | 33 | 250MHz | 280mA | 1.86Ω | 1.3GHz |
| LQW15AWR16J80□ | 160nH ±5% | 100MHz | 33 | 250MHz | 280mA | 1.86Ω | 1.3GHz |
| LQW15AWR18G80□ | 180nH ±2% | 100MHz | 33 | 250MHz | 260mA | 2.2Ω | 1.3GHz |
| LQW15AWR18H80□ | 180nH ±3% | 100MHz | 33 | 250MHz | 260mA | 2.2Ω | 1.3GHz |
| LQW15AWR18J80□ | 180nH ±5% | 100MHz | 33 | 250MHz | 260mA | 2.2Ω | 1.3GHz |
| LQW15AWR22G80□ | 220nH ±2% | 100MHz | 33 | 250MHz | 220mA | 2.75Ω | 1.1GHz |
| LQW15AWR22H80□ | 220nH ±3% | 100MHz | 33 | 250MHz | 220mA | 2.75Ω | 1.1GHz |
| LQW15AWR22J80□ | 220nH ±5% | 100MHz | 33 | 250MHz | 220mA | 2.75Ω | 1.1GHz |

Operating temp. range (Self-temp. rise included): -40 to 140°C

Only for reflow soldering

*S.R.F.: Self Resonant Frequency

In operating temperatures exceeding +85°C, derating of current is necessary for the LQW15A_80 series. Please apply the derating curve shown in the chart according to the operating temperature. Please consider "Notice (Rating)."

Inductance-Frequency Characteristics (Typ.)



Q-Frequency Characteristics (Typ.)



Notice (Rating)

In operating temperatures exceeding +85°C, derating of current is necessary for the LQW15AW_80 series. Please apply the derating curve shown in the chart according to the operating temperature.

Derating of Rated Current



LQW18AN_00 Series 0603 (1608) inch (mm)



(in mm)

| Packaging Code | Packaging | Minimum Quantity |
|----------------|---------------------|------------------|
| D | ø180mm Paper Taping | 4000 |
| J | ø330mm Paper Taping | 10000 |
| B | Packing in Bulk | 500 |

Continued on the following page. ↗

Continued from the preceding page. ↘

| Part Number (□: packaging code) | Inductance | Inductance Test Frequency | Q (min.) | Q Test Frequency | Rated Current | Max. of DC Resistance | S.R.F.* (min.) |
|------------------------------------|--------------|------------------------------|----------|------------------|---------------|-----------------------|----------------|
| LQW18AN2N2D00□ | 2.2nH ±0.5nH | 100MHz | 16 | 250MHz | 700mA | 0.042Ω | 6000MHz |
| LQW18AN3N6C00□ | 3.6nH ±0.2nH | 100MHz | 25 | 250MHz | 850mA | 0.059Ω | 6000MHz |
| LQW18AN3N6D00□ | 3.6nH ±0.5nH | 100MHz | 25 | 250MHz | 850mA | 0.059Ω | 6000MHz |
| LQW18AN3N9C00□ | 3.9nH ±0.2nH | 100MHz | 35 | 250MHz | 850mA | 0.059Ω | 6000MHz |
| LQW18AN3N9D00□ | 3.9nH ±0.5nH | 100MHz | 35 | 250MHz | 850mA | 0.059Ω | 6000MHz |
| LQW18AN4N3C00□ | 4.3nH ±0.2nH | 100MHz | 35 | 250MHz | 850mA | 0.059Ω | 6000MHz |
| LQW18AN4N3D00□ | 4.3nH ±0.5nH | 100MHz | 35 | 250MHz | 850mA | 0.059Ω | 6000MHz |
| LQW18AN4N7D00□ | 4.7nH ±0.5nH | 100MHz | 35 | 250MHz | 850mA | 0.059Ω | 6000MHz |
| LQW18AN5N6C00□ | 5.6nH ±0.2nH | 100MHz | 35 | 250MHz | 750mA | 0.082Ω | 6000MHz |
| LQW18AN5N6D00□ | 5.6nH ±0.5nH | 100MHz | 35 | 250MHz | 750mA | 0.082Ω | 6000MHz |
| LQW18AN6N2C00□ | 6.2nH ±0.2nH | 100MHz | 35 | 250MHz | 750mA | 0.082Ω | 6000MHz |
| LQW18AN6N2D00□ | 6.2nH ±0.5nH | 100MHz | 35 | 250MHz | 750mA | 0.082Ω | 6000MHz |
| LQW18AN6N8C00□ | 6.8nH ±0.2nH | 100MHz | 35 | 250MHz | 750mA | 0.082Ω | 6000MHz |
| LQW18AN6N8D00□ | 6.8nH ±0.5nH | 100MHz | 35 | 250MHz | 750mA | 0.082Ω | 6000MHz |
| LQW18AN7N5C00□ | 7.5nH ±0.2nH | 100MHz | 35 | 250MHz | 750mA | 0.082Ω | 6000MHz |
| LQW18AN7N5D00□ | 7.5nH ±0.5nH | 100MHz | 35 | 250MHz | 750mA | 0.082Ω | 6000MHz |
| LQW18AN8N2C00□ | 8.2nH ±0.2nH | 100MHz | 35 | 250MHz | 650mA | 0.11Ω | 6000MHz |
| LQW18AN8N2D00□ | 8.2nH ±0.5nH | 100MHz | 35 | 250MHz | 650mA | 0.11Ω | 6000MHz |
| LQW18AN8N7C00□ | 8.7nH ±0.2nH | 100MHz | 35 | 250MHz | 650mA | 0.11Ω | 6000MHz |
| LQW18AN8N7D00□ | 8.7nH ±0.5nH | 100MHz | 35 | 250MHz | 650mA | 0.11Ω | 6000MHz |
| LQW18AN9N1C00□ | 9.1nH ±0.2nH | 100MHz | 35 | 250MHz | 650mA | 0.11Ω | 6000MHz |
| LQW18AN9N1D00□ | 9.1nH ±0.5nH | 100MHz | 35 | 250MHz | 650mA | 0.11Ω | 6000MHz |
| LQW18AN9N5D00□ | 9.5nH ±0.5nH | 100MHz | 35 | 250MHz | 650mA | 0.11Ω | 6000MHz |
| LQW18AN10NG00□ | 10nH ±2% | 100MHz | 35 | 250MHz | 650mA | 0.11Ω | 6000MHz |
| LQW18AN10NJ00□ | 10nH ±5% | 100MHz | 35 | 250MHz | 650mA | 0.11Ω | 6000MHz |
| LQW18AN11NG00□ | 11nH ±2% | 100MHz | 35 | 250MHz | 650mA | 0.11Ω | 6000MHz |
| LQW18AN11NJ00□ | 11nH ±5% | 100MHz | 35 | 250MHz | 650mA | 0.11Ω | 6000MHz |
| LQW18AN12NG00□ | 12nH ±2% | 100MHz | 35 | 250MHz | 600mA | 0.13Ω | 6000MHz |
| LQW18AN12NJ00□ | 12nH ±5% | 100MHz | 35 | 250MHz | 600mA | 0.13Ω | 6000MHz |
| LQW18AN13NG00□ | 13nH ±2% | 100MHz | 35 | 250MHz | 600mA | 0.13Ω | 6000MHz |
| LQW18AN13NJ00□ | 13nH ±5% | 100MHz | 35 | 250MHz | 600mA | 0.13Ω | 6000MHz |
| LQW18AN15NG00□ | 15nH ±2% | 100MHz | 40 | 250MHz | 600mA | 0.13Ω | 6000MHz |
| LQW18AN15NJ00□ | 15nH ±5% | 100MHz | 40 | 250MHz | 600mA | 0.13Ω | 6000MHz |
| LQW18AN16NG00□ | 16nH ±2% | 100MHz | 40 | 250MHz | 550mA | 0.16Ω | 5500MHz |
| LQW18AN16NJ00□ | 16nH ±5% | 100MHz | 40 | 250MHz | 550mA | 0.16Ω | 5500MHz |
| LQW18AN18NG00□ | 18nH ±2% | 100MHz | 40 | 250MHz | 550mA | 0.16Ω | 5500MHz |
| LQW18AN18NJ00□ | 18nH ±5% | 100MHz | 40 | 250MHz | 550mA | 0.16Ω | 5500MHz |
| LQW18AN20NG00□ | 20nH ±2% | 100MHz | 40 | 250MHz | 550mA | 0.16Ω | 4900MHz |
| LQW18AN20NJ00□ | 20nH ±5% | 100MHz | 40 | 250MHz | 550mA | 0.16Ω | 4900MHz |
| LQW18AN22NG00□ | 22nH ±2% | 100MHz | 40 | 250MHz | 500mA | 0.17Ω | 4600MHz |
| LQW18AN22NJ00□ | 22nH ±5% | 100MHz | 40 | 250MHz | 500mA | 0.17Ω | 4600MHz |
| LQW18AN24NG00□ | 24nH ±2% | 100MHz | 40 | 250MHz | 500mA | 0.21Ω | 3800MHz |
| LQW18AN24NJ00□ | 24nH ±5% | 100MHz | 40 | 250MHz | 500mA | 0.21Ω | 3800MHz |
| LQW18AN27NG00□ | 27nH ±2% | 100MHz | 40 | 250MHz | 440mA | 0.21Ω | 3700MHz |
| LQW18AN27NJ00□ | 27nH ±5% | 100MHz | 40 | 250MHz | 440mA | 0.21Ω | 3700MHz |
| LQW18AN30NG00□ | 30nH ±2% | 100MHz | 40 | 250MHz | 420mA | 0.23Ω | 3300MHz |
| LQW18AN30NJ00□ | 30nH ±5% | 100MHz | 40 | 250MHz | 420mA | 0.23Ω | 3300MHz |
| LQW18AN33NG00□ | 33nH ±2% | 100MHz | 40 | 250MHz | 420mA | 0.23Ω | 3200MHz |
| LQW18AN33NJ00□ | 33nH ±5% | 100MHz | 40 | 250MHz | 420mA | 0.23Ω | 3200MHz |
| LQW18AN36NG00□ | 36nH ±2% | 100MHz | 40 | 250MHz | 400mA | 0.26Ω | 2900MHz |
| LQW18AN36NJ00□ | 36nH ±5% | 100MHz | 40 | 250MHz | 400mA | 0.26Ω | 2900MHz |
| LQW18AN39NG00□ | 39nH ±2% | 100MHz | 40 | 250MHz | 400mA | 0.26Ω | 2800MHz |
| LQW18AN39NJ00□ | 39nH ±5% | 100MHz | 40 | 250MHz | 400mA | 0.26Ω | 2800MHz |

Operating temp. range: -55 to 125°C
 Only for reflow soldering
 *S.R.F.: Self Resonant Frequency

Continued on the following page. ↗

Continued from the preceding page. ↘

| Part Number (□: packaging code) | Inductance | Inductance Test Frequency | Q (min.) | Q Test Frequency | Rated Current | Max. of DC Resistance | S.R.F.* (min.) |
|------------------------------------|------------|------------------------------|----------|------------------|---------------|-----------------------|----------------|
| LQW18AN43NG00□ | 43nH ±2% | 100MHz | 40 | 200MHz | 380mA | 0.29Ω | 2700MHz |
| LQW18AN43NJ00□ | 43nH ±5% | 100MHz | 40 | 200MHz | 380mA | 0.29Ω | 2700MHz |
| LQW18AN47NG00□ | 47nH ±2% | 100MHz | 38 | 200MHz | 380mA | 0.29Ω | 2600MHz |
| LQW18AN47NJ00□ | 47nH ±5% | 100MHz | 38 | 200MHz | 380mA | 0.29Ω | 2600MHz |
| LQW18AN51NG00□ | 51nH ±2% | 100MHz | 38 | 200MHz | 370mA | 0.33Ω | 2500MHz |
| LQW18AN51NJ00□ | 51nH ±5% | 100MHz | 38 | 200MHz | 370mA | 0.33Ω | 2500MHz |
| LQW18AN56NG00□ | 56nH ±2% | 100MHz | 38 | 200MHz | 360mA | 0.35Ω | 2400MHz |
| LQW18AN56NJ00□ | 56nH ±5% | 100MHz | 38 | 200MHz | 360mA | 0.35Ω | 2400MHz |
| LQW18AN62NG00□ | 62nH ±2% | 100MHz | 38 | 200MHz | 280mA | 0.51Ω | 2300MHz |
| LQW18AN62NJ00□ | 62nH ±5% | 100MHz | 38 | 200MHz | 280mA | 0.51Ω | 2300MHz |
| LQW18AN68NG00□ | 68nH ±2% | 100MHz | 38 | 200MHz | 340mA | 0.38Ω | 2200MHz |
| LQW18AN68NJ00□ | 68nH ±5% | 100MHz | 38 | 200MHz | 340mA | 0.38Ω | 2200MHz |
| LQW18AN72NG00□ | 72nH ±2% | 100MHz | 34 | 150MHz | 270mA | 0.56Ω | 2100MHz |
| LQW18AN72NJ00□ | 72nH ±5% | 100MHz | 34 | 150MHz | 270mA | 0.56Ω | 2100MHz |
| LQW18AN75NG00□ | 75nH ±2% | 100MHz | 34 | 150MHz | 270mA | 0.56Ω | 2050MHz |
| LQW18AN75NJ00□ | 75nH ±5% | 100MHz | 34 | 150MHz | 270mA | 0.56Ω | 2050MHz |
| LQW18AN82NG00□ | 82nH ±2% | 100MHz | 34 | 150MHz | 250mA | 0.60Ω | 2000MHz |
| LQW18AN82NJ00□ | 82nH ±5% | 100MHz | 34 | 150MHz | 250mA | 0.60Ω | 2000MHz |
| LQW18AN91NG00□ | 91nH ±2% | 100MHz | 34 | 150MHz | 230mA | 0.64Ω | 1900MHz |
| LQW18AN91NJ00□ | 91nH ±5% | 100MHz | 34 | 150MHz | 230mA | 0.64Ω | 1900MHz |
| LQW18ANR10G00□ | 100nH ±2% | 100MHz | 34 | 150MHz | 220mA | 0.68Ω | 1800MHz |
| LQW18ANR10J00□ | 100nH ±5% | 100MHz | 34 | 150MHz | 220mA | 0.68Ω | 1800MHz |
| LQW18ANR11G00□ | 110nH ±2% | 100MHz | 32 | 150MHz | 200mA | 1.2Ω | 1700MHz |
| LQW18ANR11J00□ | 110nH ±5% | 100MHz | 32 | 150MHz | 200mA | 1.2Ω | 1700MHz |
| LQW18ANR12G00□ | 120nH ±2% | 100MHz | 32 | 150MHz | 180mA | 1.3Ω | 1600MHz |
| LQW18ANR12J00□ | 120nH ±5% | 100MHz | 32 | 150MHz | 180mA | 1.3Ω | 1600MHz |
| LQW18ANR13G00□ | 130nH ±2% | 100MHz | 32 | 150MHz | 170mA | 1.4Ω | 1450MHz |
| LQW18ANR13J00□ | 130nH ±5% | 100MHz | 32 | 150MHz | 170mA | 1.4Ω | 1450MHz |
| LQW18ANR15G00□ | 150nH ±2% | 100MHz | 32 | 150MHz | 160mA | 1.5Ω | 1400MHz |
| LQW18ANR15J00□ | 150nH ±5% | 100MHz | 32 | 150MHz | 160mA | 1.5Ω | 1400MHz |
| LQW18ANR16G00□ | 160nH ±2% | 100MHz | 32 | 150MHz | 150mA | 2.1Ω | 1350MHz |
| LQW18ANR16J00□ | 160nH ±5% | 100MHz | 32 | 150MHz | 150mA | 2.1Ω | 1350MHz |
| LQW18ANR18G00□ | 180nH ±2% | 100MHz | 25 | 100MHz | 140mA | 2.2Ω | 1300MHz |
| LQW18ANR18J00□ | 180nH ±5% | 100MHz | 25 | 100MHz | 140mA | 2.2Ω | 1300MHz |
| LQW18ANR20G00□ | 200nH ±2% | 100MHz | 25 | 100MHz | 120mA | 2.4Ω | 1250MHz |
| LQW18ANR20J00□ | 200nH ±5% | 100MHz | 25 | 100MHz | 120mA | 2.4Ω | 1250MHz |
| LQW18ANR22G00□ | 220nH ±2% | 100MHz | 25 | 100MHz | 120mA | 2.5Ω | 1200MHz |
| LQW18ANR22J00□ | 220nH ±5% | 100MHz | 25 | 100MHz | 120mA | 2.5Ω | 1200MHz |
| LQW18ANR27G00□ | 270nH ±2% | 100MHz | 30 | 100MHz | 110mA | 3.4Ω | 960MHz |
| LQW18ANR27J00□ | 270nH ±5% | 100MHz | 30 | 100MHz | 110mA | 3.4Ω | 960MHz |
| LQW18ANR33G00□ | 330nH ±2% | 100MHz | 30 | 100MHz | 85mA | 5.5Ω | 800MHz |
| LQW18ANR33J00□ | 330nH ±5% | 100MHz | 30 | 100MHz | 85mA | 5.5Ω | 800MHz |
| LQW18ANR39G00□ | 390nH ±2% | 100MHz | 30 | 100MHz | 80mA | 6.2Ω | 800MHz |
| LQW18ANR39J00□ | 390nH ±5% | 100MHz | 30 | 100MHz | 80mA | 6.2Ω | 800MHz |
| LQW18ANR47G00□ | 470nH ±2% | 100MHz | 30 | 100MHz | 75mA | 7.0Ω | 700MHz |
| LQW18ANR47J00□ | 470nH ±5% | 100MHz | 30 | 100MHz | 75mA | 7.0Ω | 700MHz |

Operating temp. range: -55 to 125°C

Only for reflow soldering

*S.R.F.: Self Resonant Frequency

Continued on the following page. ↗

Continued from the preceding page. ↘

Inductance-Frequency Characteristics (Typ.)



Q-Frequency Characteristics (Typ.)



LQW18AN_10 Series 0603 (1608) inch (mm)

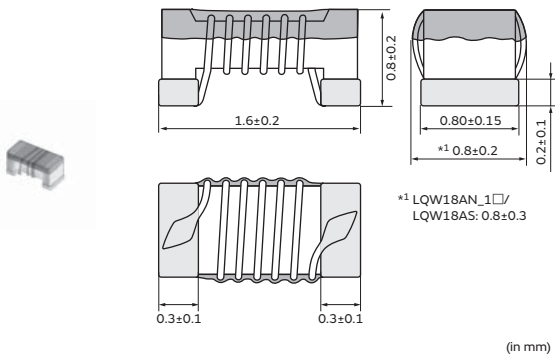

| Packaging Code | Packaging | Minimum Quantity |
|----------------|---------------------|------------------|
| D | ø180mm Paper Taping | 4000 |
| J | ø330mm Paper Taping | 10000 |
| B | Packing in Bulk | 500 |

| Part Number (□: packaging code) | Inductance | Inductance Test Frequency | Q (min.) | Q Test Frequency | Rated Current | Max. of DC Resistance | S.R.F.* (min.) |
|------------------------------------|--------------|---------------------------|----------|------------------|---------------|-----------------------|----------------|
| LQW18AN2N2D10□ | 2.2nH ±0.5nH | 100MHz | 25 | 250MHz | 1400mA | 0.018Ω | 18000MHz |
| LQW18AN3N9C10□ | 3.9nH ±0.2nH | 100MHz | 38 | 250MHz | 1000mA | 0.032Ω | 11000MHz |
| LQW18AN3N9D10□ | 3.9nH ±0.5nH | 100MHz | 38 | 250MHz | 1000mA | 0.032Ω | 11000MHz |
| LQW18AN5N6D10□ | 5.6nH ±0.5nH | 100MHz | 38 | 250MHz | 900mA | 0.045Ω | 10000MHz |
| LQW18AN6N8C10□ | 6.8nH ±0.2nH | 100MHz | 38 | 250MHz | 900mA | 0.045Ω | 7000MHz |
| LQW18AN6N8D10□ | 6.8nH ±0.5nH | 100MHz | 38 | 250MHz | 900mA | 0.045Ω | 7000MHz |
| LQW18AN8N2D10□ | 8.2nH ±0.5nH | 100MHz | 38 | 250MHz | 800mA | 0.058Ω | 7000MHz |
| LQW18AN10NG10□ | 10nH ±2% | 100MHz | 38 | 250MHz | 800mA | 0.058Ω | 5000MHz |
| LQW18AN10NJ10□ | 10nH ±5% | 100MHz | 38 | 250MHz | 800mA | 0.058Ω | 5000MHz |
| LQW18AN12NG10□ | 12nH ±2% | 100MHz | 38 | 250MHz | 750mA | 0.071Ω | 5000MHz |
| LQW18AN12NJ10□ | 12nH ±5% | 100MHz | 38 | 250MHz | 750mA | 0.071Ω | 5000MHz |
| LQW18AN15NJ10□ | 15nH ±5% | 100MHz | 42 | 250MHz | 700mA | 0.085Ω | 4500MHz |
| LQW18AN18NG10□ | 18nH ±2% | 100MHz | 42 | 250MHz | 700mA | 0.085Ω | 3500MHz |
| LQW18AN18NJ10□ | 18nH ±5% | 100MHz | 42 | 250MHz | 700mA | 0.085Ω | 3500MHz |
| LQW18AN22NG10□ | 22nH ±2% | 100MHz | 42 | 250MHz | 640mA | 0.099Ω | 3200MHz |
| LQW18AN22NJ10□ | 22nH ±5% | 100MHz | 42 | 250MHz | 640mA | 0.099Ω | 3200MHz |
| LQW18AN27NG10□ | 27nH ±2% | 100MHz | 42 | 250MHz | 590mA | 0.116Ω | 2800MHz |
| LQW18AN27NJ10□ | 27nH ±5% | 100MHz | 42 | 250MHz | 590mA | 0.116Ω | 2800MHz |
| LQW18AN33NJ10□ | 33nH ±5% | 100MHz | 42 | 250MHz | 550mA | 0.132Ω | 2500MHz |

Operating temp. range: -55 to 125°C
 Only for reflow soldering
 *S.R.F.: Self Resonant Frequency

Continued on the following page. ↗

Continued from the preceding page. ↘

Inductance-Frequency Characteristics (Typ.)



Q-Frequency Characteristics (Typ.)



LQW18AN_80 Series 0603 (1608) inch (mm)



| Packaging Code | Packaging | Minimum Quantity |
|----------------|---------------------|------------------|
| D | ø180mm Paper Taping | 4000 |
| J | ø330mm Paper Taping | 10000 |
| B | Packing in Bulk | 500 |

| Part Number (□: packaging code) | Inductance | Inductance Test Frequency | Q (min.) | Q Test Frequency | Rated Current | Max. of DC Resistance | S.R.F.* (min.) |
|------------------------------------|--------------|---------------------------|----------|------------------|---------------|-----------------------|----------------|
| LQW18AN2N2C80□ | 2.2nH ±0.2nH | 100MHz | 24 | 250MHz | 3200mA | 0.018Ω | 15000MHz |
| LQW18AN2N4C80□ | 2.4nH ±0.2nH | 100MHz | 18 | 250MHz | 2400mA | 0.026Ω | 15000MHz |
| LQW18AN3N0C80□ | 3.0nH ±0.2nH | 100MHz | 13 | 250MHz | 670mA | 0.17Ω | 15000MHz |
| LQW18AN3N9B80□ | 3.9nH ±0.1nH | 100MHz | 30 | 250MHz | 2200mA | 0.028Ω | 10000MHz |
| LQW18AN3N9C80□ | 3.9nH ±0.2nH | 100MHz | 30 | 250MHz | 2200mA | 0.028Ω | 10000MHz |
| LQW18AN3N9G80□ | 3.9nH ±2% | 100MHz | 30 | 250MHz | 2200mA | 0.028Ω | 10000MHz |
| LQW18AN4N1B80□ | 4.1nH ±0.1nH | 100MHz | 30 | 250MHz | 2200mA | 0.028Ω | 10000MHz |
| LQW18AN4N1C80□ | 4.1nH ±0.2nH | 100MHz | 30 | 250MHz | 2200mA | 0.028Ω | 10000MHz |
| LQW18AN4N1G80□ | 4.1nH ±2% | 100MHz | 30 | 250MHz | 2200mA | 0.028Ω | 10000MHz |
| LQW18AN4N2B80□ | 4.2nH ±0.1nH | 100MHz | 30 | 250MHz | 2200mA | 0.028Ω | 10000MHz |
| LQW18AN4N2C80□ | 4.2nH ±0.2nH | 100MHz | 30 | 250MHz | 2200mA | 0.028Ω | 10000MHz |
| LQW18AN4N2G80□ | 4.2nH ±2% | 100MHz | 30 | 250MHz | 2200mA | 0.028Ω | 10000MHz |
| LQW18AN4N3B80□ | 4.3nH ±0.1nH | 100MHz | 35 | 250MHz | 2100mA | 0.036Ω | 11600MHz |
| LQW18AN4N3C80□ | 4.3nH ±0.2nH | 100MHz | 35 | 250MHz | 2100mA | 0.036Ω | 11600MHz |
| LQW18AN4N3G80□ | 4.3nH ±2% | 100MHz | 35 | 250MHz | 2100mA | 0.036Ω | 11600MHz |
| LQW18AN4N7B80□ | 4.7nH ±0.1nH | 100MHz | 25 | 250MHz | 1500mA | 0.054Ω | 10400MHz |
| LQW18AN4N7C80□ | 4.7nH ±0.2nH | 100MHz | 25 | 250MHz | 1500mA | 0.054Ω | 10400MHz |
| LQW18AN4N7G80□ | 4.7nH ±2% | 100MHz | 25 | 250MHz | 1500mA | 0.054Ω | 10400MHz |
| LQW18AN4N9B80□ | 4.9nH ±0.1nH | 100MHz | 23 | 250MHz | 1200mA | 0.081Ω | 7300MHz |
| LQW18AN4N9C80□ | 4.9nH ±0.2nH | 100MHz | 23 | 250MHz | 1200mA | 0.081Ω | 7300MHz |
| LQW18AN4N9G80□ | 4.9nH ±2% | 100MHz | 23 | 250MHz | 1200mA | 0.081Ω | 7300MHz |
| LQW18AN5N6C80□ | 5.6nH ±0.2nH | 100MHz | 38 | 250MHz | 1900mA | 0.04Ω | 6650MHz |
| LQW18AN5N6G80□ | 5.6nH ±2% | 100MHz | 38 | 250MHz | 1900mA | 0.040Ω | 6650MHz |
| LQW18AN6N0C80□ | 6.0nH ±0.2nH | 100MHz | 40 | 250MHz | 1900mA | 0.04Ω | 6650MHz |

Operating temp. range: -55 to 125°C
 Only for reflow soldering

*S.R.F.: Self Resonant Frequency

In operating temperatures exceeding +85°C, derating of current is necessary for the LQW18AN_80 series. Please apply the derating curve shown in the chart according to the operating temperature. Please consider "Notice (Rating)."

Continued on the following page. ↗

Continued from the preceding page. ↘

| Part Number (□: packaging code) | Inductance | Inductance Test Frequency | Q (min.) | Q Test Frequency | Rated Current | Max. of DC Resistance | S.R.F.* (min.) |
|------------------------------------|--------------|------------------------------|----------|------------------|---------------|-----------------------|----------------|
| LQW18AN6NOG80□ | 6nH ±2% | 100MHz | 40 | 250MHz | 1900mA | 0.040Ω | 6650MHz |
| LQW18AN6N5C80□ | 6.5nH ±0.2nH | 100MHz | 40 | 250MHz | 1900mA | 0.04Ω | 6650MHz |
| LQW18AN6N5G80□ | 6.5nH ±2% | 100MHz | 40 | 250MHz | 1900mA | 0.040Ω | 6650MHz |
| LQW18AN6N8C80□ | 6.8nH ±0.2nH | 100MHz | 40 | 250MHz | 1900mA | 0.04Ω | 6650MHz |
| LQW18AN6N8G80□ | 6.8nH ±2% | 100MHz | 40 | 250MHz | 1900mA | 0.040Ω | 6650MHz |
| LQW18AN7N2C80□ | 7.2nH ±0.2nH | 100MHz | 38 | 250MHz | 1900mA | 0.04Ω | 6650MHz |
| LQW18AN7N2G80□ | 7.2nH ±2% | 100MHz | 38 | 250MHz | 1900mA | 0.040Ω | 6650MHz |
| LQW18AN7N5C80□ | 7.5nH ±0.2nH | 100MHz | 35 | 250MHz | 1500mA | 0.048Ω | 7000MHz |
| LQW18AN7N5G80□ | 7.5nH ±2% | 100MHz | 35 | 250MHz | 1500mA | 0.048Ω | 7000MHz |
| LQW18AN8N2C80□ | 8.2nH ±0.2nH | 100MHz | 38 | 250MHz | 1600mA | 0.052Ω | 4750MHz |
| LQW18AN8N2G80□ | 8.2nH ±2% | 100MHz | 38 | 250MHz | 1600mA | 0.052Ω | 4750MHz |
| LQW18AN8N4C80□ | 8.4nH ±0.2nH | 100MHz | 38 | 250MHz | 1600mA | 0.052Ω | 4750MHz |
| LQW18AN8N4G80□ | 8.4nH ±2% | 100MHz | 38 | 250MHz | 1600mA | 0.052Ω | 4750MHz |
| LQW18AN8N7C80□ | 8.7nH ±0.2nH | 100MHz | 38 | 250MHz | 1600mA | 0.052Ω | 4750MHz |
| LQW18AN8N7G80□ | 8.7nH ±2% | 100MHz | 38 | 250MHz | 1600mA | 0.052Ω | 4750MHz |
| LQW18AN9N1C80□ | 9.1nH ±0.2nH | 100MHz | 38 | 250MHz | 1600mA | 0.052Ω | 4750MHz |
| LQW18AN9N1G80□ | 9.1nH ±2% | 100MHz | 38 | 250MHz | 1600mA | 0.052Ω | 4750MHz |
| LQW18AN9N5C80□ | 9.5nH ±0.2nH | 100MHz | 38 | 250MHz | 1600mA | 0.052Ω | 4750MHz |
| LQW18AN9N5G80□ | 9.5nH ±2% | 100MHz | 38 | 250MHz | 1600mA | 0.052Ω | 4750MHz |
| LQW18AN9N9C80□ | 9.9nH ±0.2nH | 100MHz | 38 | 250MHz | 1600mA | 0.052Ω | 4750MHz |
| LQW18AN9N9G80□ | 9.9nH ±2% | 100MHz | 38 | 250MHz | 1600mA | 0.052Ω | 4750MHz |
| LQW18AN10NG80□ | 10nH ±2% | 100MHz | 38 | 250MHz | 1600mA | 0.052Ω | 4750MHz |
| LQW18AN10NJ80□ | 10nH ±5% | 100MHz | 38 | 250MHz | 1600mA | 0.052Ω | 4750MHz |
| LQW18AN11NG80□ | 11nH ±2% | 100MHz | 40 | 250MHz | 1600mA | 0.052Ω | 4750MHz |
| LQW18AN11NJ80□ | 11nH ±5% | 100MHz | 40 | 250MHz | 1600mA | 0.052Ω | 4750MHz |
| LQW18AN12NG80□ | 12nH ±2% | 100MHz | 37 | 250MHz | 1500mA | 0.064Ω | 5000MHz |
| LQW18AN12NJ80□ | 12nH ±5% | 100MHz | 37 | 250MHz | 1500mA | 0.064Ω | 5000MHz |
| LQW18AN13NG80□ | 13nH ±2% | 100MHz | 37 | 250MHz | 1500mA | 0.064Ω | 5000MHz |
| LQW18AN13NJ80□ | 13nH ±5% | 100MHz | 37 | 250MHz | 1500mA | 0.064Ω | 5000MHz |
| LQW18AN15NG80□ | 15nH ±2% | 100MHz | 38 | 250MHz | 1400mA | 0.075Ω | 4600MHz |
| LQW18AN15NJ80□ | 15nH ±5% | 100MHz | 38 | 250MHz | 1400mA | 0.075Ω | 4600MHz |
| LQW18AN16NG80□ | 16nH ±2% | 100MHz | 40 | 250MHz | 1400mA | 0.075Ω | 4600MHz |
| LQW18AN16NJ80□ | 16nH ±5% | 100MHz | 40 | 250MHz | 1400mA | 0.075Ω | 4600MHz |
| LQW18AN17NG80□ | 17nH ±2% | 100MHz | 40 | 250MHz | 1400mA | 0.075Ω | 4600MHz |
| LQW18AN17NJ80□ | 17nH ±5% | 100MHz | 40 | 250MHz | 1400mA | 0.075Ω | 4600MHz |
| LQW18AN18NG80□ | 18nH ±2% | 100MHz | 40 | 250MHz | 1400mA | 0.075Ω | 4600MHz |
| LQW18AN18NJ80□ | 18nH ±5% | 100MHz | 40 | 250MHz | 1400mA | 0.075Ω | 4600MHz |
| LQW18AN19NG80□ | 19nH ±2% | 100MHz | 40 | 250MHz | 1400mA | 0.075Ω | 4600MHz |
| LQW18AN19NJ80□ | 19nH ±5% | 100MHz | 40 | 250MHz | 1400mA | 0.075Ω | 4600MHz |
| LQW18AN22NG80□ | 22nH ±2% | 100MHz | 40 | 250MHz | 1300mA | 0.086Ω | 3450MHz |
| LQW18AN22NJ80□ | 22nH ±5% | 100MHz | 40 | 250MHz | 1300mA | 0.086Ω | 3450MHz |
| LQW18AN23NG80□ | 23nH ±2% | 100MHz | 40 | 250MHz | 1300mA | 0.086Ω | 3450MHz |
| LQW18AN23NJ80□ | 23nH ±5% | 100MHz | 40 | 250MHz | 1300mA | 0.086Ω | 3450MHz |
| LQW18AN24NG80□ | 24nH ±2% | 100MHz | 40 | 250MHz | 1300mA | 0.086Ω | 3450MHz |
| LQW18AN24NJ80□ | 24nH ±5% | 100MHz | 40 | 250MHz | 1300mA | 0.086Ω | 3450MHz |
| LQW18AN25NG80□ | 25nH ±2% | 100MHz | 40 | 250MHz | 1200mA | 0.098Ω | 3600MHz |
| LQW18AN25NJ80□ | 25nH ±5% | 100MHz | 40 | 250MHz | 1200mA | 0.098Ω | 3600MHz |
| LQW18AN27NG80□ | 27nH ±2% | 100MHz | 40 | 250MHz | 1200mA | 0.098Ω | 3600MHz |
| LQW18AN27NJ80□ | 27nH ±5% | 100MHz | 40 | 250MHz | 1200mA | 0.098Ω | 3600MHz |
| LQW18AN28NG80□ | 28nH ±2% | 100MHz | 40 | 250MHz | 1200mA | 0.098Ω | 3600MHz |
| LQW18AN28NJ80□ | 28nH ±5% | 100MHz | 40 | 250MHz | 1200mA | 0.098Ω | 3600MHz |

Operating temp. range: -55 to 125°C

Only for reflow soldering

*S.R.F.: Self Resonant Frequency

In operating temperatures exceeding +85°C, derating of current is necessary for the LQW18AN_80 series. Please apply the derating curve shown in the chart according to the operating temperature. Please consider "Notice (Rating)."

Continued on the following page. ↗

Continued from the preceding page. ↘

| Part Number (□: packaging code) | Inductance | Inductance Test Frequency | Q (min.) | Q Test Frequency | Rated Current | Max. of DC Resistance | S.R.F.* (min.) |
|------------------------------------|------------|------------------------------|----------|------------------|---------------|-----------------------|----------------|
| LQW18AN30NG80□ | 30nH ±2% | 100MHz | 40 | 250MHz | 1100mA | 0.12Ω | 2880MHz |
| LQW18AN30NJ80□ | 30nH ±5% | 100MHz | 40 | 250MHz | 1100mA | 0.12Ω | 2880MHz |
| LQW18AN31NG80□ | 31nH ±2% | 100MHz | 40 | 250MHz | 1100mA | 0.11Ω | 3150MHz |
| LQW18AN31NJ80□ | 31nH ±5% | 100MHz | 40 | 250MHz | 1100mA | 0.11Ω | 3150MHz |
| LQW18AN33NG80□ | 33nH ±2% | 100MHz | 40 | 250MHz | 1100mA | 0.11Ω | 3150MHz |
| LQW18AN33NJ80□ | 33nH ±5% | 100MHz | 40 | 250MHz | 1100mA | 0.11Ω | 3150MHz |
| LQW18AN34NG80□ | 34nH ±2% | 100MHz | 40 | 250MHz | 1050mA | 0.15Ω | 3000MHz |
| LQW18AN34NJ80□ | 34nH ±5% | 100MHz | 40 | 250MHz | 1050mA | 0.15Ω | 3000MHz |
| LQW18AN36NG80□ | 36nH ±2% | 100MHz | 37 | 250MHz | 910mA | 0.20Ω | 3000MHz |
| LQW18AN36NJ80□ | 36nH ±5% | 100MHz | 37 | 250MHz | 910mA | 0.20Ω | 3000MHz |
| LQW18AN37NG80□ | 37nH ±2% | 100MHz | 37 | 250MHz | 910mA | 0.20Ω | 3000MHz |
| LQW18AN37NJ80□ | 37nH ±5% | 100MHz | 37 | 250MHz | 910mA | 0.20Ω | 3000MHz |
| LQW18AN39NG80□ | 39nH ±2% | 100MHz | 40 | 250MHz | 1000mA | 0.16Ω | 3280MHz |
| LQW18AN39NJ80□ | 39nH ±5% | 100MHz | 40 | 250MHz | 1000mA | 0.16Ω | 3280MHz |
| LQW18AN41NG80□ | 41nH ±2% | 100MHz | 40 | 250MHz | 1000mA | 0.16Ω | 3280MHz |
| LQW18AN41NJ80□ | 41nH ±5% | 100MHz | 40 | 250MHz | 1000mA | 0.16Ω | 3280MHz |
| LQW18AN43NG80□ | 43nH ±2% | 100MHz | 40 | 250MHz | 840mA | 0.21Ω | 2780MHz |
| LQW18AN43NJ80□ | 43nH ±5% | 100MHz | 40 | 250MHz | 840mA | 0.21Ω | 2780MHz |
| LQW18AN44NG80□ | 44nH ±2% | 100MHz | 40 | 250MHz | 840mA | 0.21Ω | 2780MHz |
| LQW18AN44NJ80□ | 44nH ±5% | 100MHz | 40 | 250MHz | 840mA | 0.21Ω | 2780MHz |
| LQW18AN47NG80□ | 47nH ±2% | 100MHz | 32 | 200MHz | 830mA | 0.23Ω | 2700MHz |
| LQW18AN47NJ80□ | 47nH ±5% | 100MHz | 32 | 200MHz | 830mA | 0.23Ω | 2700MHz |
| LQW18AN48NG80□ | 48nH ±2% | 100MHz | 32 | 200MHz | 830mA | 0.23Ω | 2700MHz |
| LQW18AN48NJ80□ | 48nH ±5% | 100MHz | 32 | 200MHz | 830mA | 0.23Ω | 2700MHz |
| LQW18AN51NG80□ | 51nH ±2% | 100MHz | 32 | 200MHz | 830mA | 0.23Ω | 2700MHz |
| LQW18AN51NJ80□ | 51nH ±5% | 100MHz | 32 | 200MHz | 830mA | 0.23Ω | 2700MHz |
| LQW18AN52NG80□ | 52nH ±2% | 100MHz | 35 | 200MHz | 750mA | 0.27Ω | 2750MHz |
| LQW18AN52NJ80□ | 52nH ±5% | 100MHz | 35 | 200MHz | 750mA | 0.27Ω | 2750MHz |
| LQW18AN56NG80□ | 56nH ±2% | 100MHz | 38 | 200MHz | 770mA | 0.26Ω | 2600MHz |
| LQW18AN56NJ80□ | 56nH ±5% | 100MHz | 38 | 200MHz | 770mA | 0.26Ω | 2600MHz |
| LQW18AN58NG80□ | 58nH ±2% | 100MHz | 35 | 200MHz | 700mA | 0.30Ω | 2400MHz |
| LQW18AN58NJ80□ | 58nH ±5% | 100MHz | 35 | 200MHz | 700mA | 0.30Ω | 2400MHz |
| LQW18AN68NG80□ | 68nH ±2% | 100MHz | 37 | 200MHz | 630mA | 0.38Ω | 2380MHz |
| LQW18AN68NJ80□ | 68nH ±5% | 100MHz | 37 | 200MHz | 630mA | 0.38Ω | 2380MHz |
| LQW18AN69NG80□ | 69nH ±2% | 100MHz | 37 | 200MHz | 630mA | 0.38Ω | 2380MHz |
| LQW18AN69NJ80□ | 69nH ±5% | 100MHz | 37 | 200MHz | 630mA | 0.38Ω | 2380MHz |
| LQW18AN72NG80□ | 72nH ±2% | 100MHz | 34 | 150MHz | 560mA | 0.47Ω | 2330MHz |
| LQW18AN72NJ80□ | 72nH ±5% | 100MHz | 34 | 150MHz | 560mA | 0.47Ω | 2330MHz |
| LQW18AN73NG80□ | 73nH ±2% | 100MHz | 28 | 150MHz | 590mA | 0.41Ω | 2280MHz |
| LQW18AN73NJ80□ | 73nH ±5% | 100MHz | 28 | 150MHz | 590mA | 0.41Ω | 2280MHz |
| LQW18AN75NG80□ | 75nH ±2% | 100MHz | 28 | 150MHz | 590mA | 0.41Ω | 2280MHz |
| LQW18AN75NJ80□ | 75nH ±5% | 100MHz | 28 | 150MHz | 590mA | 0.41Ω | 2280MHz |
| LQW18AN78NG80□ | 78nH ±2% | 100MHz | 28 | 150MHz | 590mA | 0.41Ω | 2280MHz |
| LQW18AN78NJ80□ | 78nH ±5% | 100MHz | 28 | 150MHz | 590mA | 0.41Ω | 2280MHz |
| LQW18AN82NG80□ | 82nH ±2% | 100MHz | 34 | 150MHz | 550mA | 0.5Ω | 2230MHz |
| LQW18AN82NJ80□ | 82nH ±5% | 100MHz | 34 | 150MHz | 550mA | 0.5Ω | 2230MHz |
| LQW18AN83NG80□ | 83nH ±2% | 100MHz | 34 | 150MHz | 550mA | 0.5Ω | 2230MHz |
| LQW18AN83NJ80□ | 83nH ±5% | 100MHz | 34 | 150MHz | 550mA | 0.5Ω | 2230MHz |
| LQW18AN91NG80□ | 91nH ±2% | 100MHz | 33 | 150MHz | 520mA | 0.54Ω | 1900MHz |
| LQW18AN91NJ80□ | 91nH ±5% | 100MHz | 33 | 150MHz | 520mA | 0.54Ω | 1900MHz |
| LQW18AN94NG80□ | 94nH ±2% | 100MHz | 34 | 150MHz | 490mA | 0.63Ω | 1750MHz |

Operating temp. range: -55 to 125°C

Only for reflow soldering

*S.R.F.: Self Resonant Frequency

In operating temperatures exceeding +85°C, derating of current is necessary for the LQW18AN_80 series. Please apply the derating curve shown in the chart according to the operating temperature. Please consider "Notice (Rating)."

Continued on the following page. ↗

Continued from the preceding page. ↘

| Part Number (□: packaging code) | Inductance | Inductance Test Frequency | Q (min.) | Q Test Frequency | Rated Current | Max. of DC Resistance | S.R.F.* (min.) |
|------------------------------------|------------|---------------------------|----------|------------------|---------------|-----------------------|----------------|
| LQW18AN94NJ80□ | 94nH ±5% | 100MHz | 34 | 150MHz | 490mA | 0.63Ω | 1750MHz |
| LQW18ANR10G80□ | 100nH ±2% | 100MHz | 34 | 150MHz | 490mA | 0.63Ω | 1750MHz |
| LQW18ANR10J80□ | 100nH ±5% | 100MHz | 34 | 150MHz | 490mA | 0.63Ω | 1750MHz |
| LQW18ANR11G80□ | 110nH ±2% | 100MHz | 32 | 150MHz | 450mA | 0.7Ω | 1730MHz |
| LQW18ANR11J80□ | 110nH ±5% | 100MHz | 32 | 150MHz | 450mA | 0.7Ω | 1730MHz |
| LQW18ANR12G80□ | 120nH ±2% | 100MHz | 32 | 150MHz | 450mA | 0.72Ω | 1650MHz |
| LQW18ANR12J80□ | 120nH ±5% | 100MHz | 32 | 150MHz | 450mA | 0.72Ω | 1650MHz |
| LQW18ANR15G80□ | 150nH ±2% | 100MHz | 28 | 150MHz | 420mA | 0.87Ω | 1580MHz |
| LQW18ANR15J80□ | 150nH ±5% | 100MHz | 28 | 150MHz | 420mA | 0.87Ω | 1580MHz |
| LQW18ANR18G80□ | 180nH ±2% | 100MHz | 25 | 100MHz | 310mA | 1.65Ω | 1380MHz |
| LQW18ANR18J80□ | 180nH ±5% | 100MHz | 25 | 100MHz | 310mA | 1.65Ω | 1380MHz |
| LQW18ANR20G80□ | 200nH ±2% | 100MHz | 25 | 100MHz | 290mA | 1.74Ω | 1350MHz |
| LQW18ANR20J80□ | 200nH ±5% | 100MHz | 25 | 100MHz | 290mA | 1.74Ω | 1350MHz |
| LQW18ANR21G80□ | 210nH ±2% | 100MHz | 27 | 100MHz | 280mA | 1.98Ω | 1330MHz |
| LQW18ANR21J80□ | 210nH ±5% | 100MHz | 27 | 100MHz | 280mA | 1.98Ω | 1330MHz |
| LQW18ANR22G80□ | 220nH ±2% | 100MHz | 25 | 100MHz | 280mA | 2.08Ω | 1330MHz |
| LQW18ANR22J80□ | 220nH ±5% | 100MHz | 25 | 100MHz | 280mA | 2.08Ω | 1330MHz |
| LQW18ANR25G80□ | 250nH ±2% | 100MHz | 24 | 100MHz | 250mA | 2.28Ω | 1330MHz |
| LQW18ANR25J80□ | 250nH ±5% | 100MHz | 24 | 100MHz | 250mA | 2.28Ω | 1330MHz |
| LQW18ANR27G80□ | 270nH ±2% | 100MHz | 24 | 100MHz | 260mA | 2.42Ω | 1250MHz |
| LQW18ANR27J80□ | 270nH ±5% | 100MHz | 24 | 100MHz | 260mA | 2.42Ω | 1250MHz |
| LQW18ANR30G80□ | 300nH ±2% | 100MHz | 25 | 100MHz | 220mA | 3.12Ω | 1200MHz |
| LQW18ANR30J80□ | 300nH ±5% | 100MHz | 25 | 100MHz | 220mA | 3.12Ω | 1200MHz |
| LQW18ANR33G80□ | 330nH ±2% | 100MHz | 25 | 100MHz | 190mA | 3.84Ω | 1100MHz |
| LQW18ANR33J80□ | 330nH ±5% | 100MHz | 25 | 100MHz | 190mA | 3.84Ω | 1100MHz |
| LQW18ANR36G80□ | 360nH ±2% | 100MHz | 25 | 100MHz | 190mA | 3.98Ω | 1050MHz |
| LQW18ANR36J80□ | 360nH ±5% | 100MHz | 25 | 100MHz | 190mA | 3.98Ω | 1050MHz |
| LQW18ANR39G80□ | 390nH ±2% | 100MHz | 25 | 100MHz | 190mA | 4.23Ω | 1100MHz |
| LQW18ANR39J80□ | 390nH ±5% | 100MHz | 25 | 100MHz | 190mA | 4.23Ω | 1100MHz |

Operating temp. range: -55 to 125°C

Only for reflow soldering

*S.R.F.: Self Resonant Frequency

In operating temperatures exceeding +85°C, derating of current is necessary for the LQW18AN_80 series. Please apply the derating curve shown in the chart according to the operating temperature. Please consider "Notice (Rating)."

Inductance-Frequency Characteristics (Typ.)



Q-Frequency Characteristics (Typ.)



Notice (Rating)

In operating temperatures exceeding +85°C, derating of current is necessary for this series.

Please apply the derating curve shown in the chart according to the operating temperature.

Derating of Rated Current



LQW18AS_00 Series 0603 (1608) inch (mm)



| Packaging Code | Packaging | Minimum Quantity |
|----------------|---------------------|------------------|
| D | ø180mm Paper Taping | 4000 |
| J | ø330mm Paper Taping | 10000 |
| B | Packing in Bulk | 500 |

| Part Number (□: packaging code) | Inductance | Inductance Test Frequency | Q (min.) | Q Test Frequency | Rated Current | Max. of DC Resistance | S.R.F.* (min.) |
|------------------------------------|------------|------------------------------|----------|------------------|---------------|-----------------------|----------------|
| LQW18AS1N6J00□ | 1.6nH ±5% | 250MHz | 24 | 250MHz | 700mA | 0.030Ω | 12500MHz |
| LQW18AS1N8J00□ | 1.8nH ±5% | 250MHz | 16 | 250MHz | 700mA | 0.045Ω | 12500MHz |
| LQW18AS3N3G00□ | 3.3nH ±2% | 250MHz | 35 | 250MHz | 700mA | 0.045Ω | 5900MHz |
| LQW18AS3N3J00□ | 3.3nH ±5% | 250MHz | 35 | 250MHz | 700mA | 0.045Ω | 5900MHz |
| LQW18AS3N6G00□ | 3.6nH ±2% | 250MHz | 22 | 250MHz | 700mA | 0.063Ω | 5900MHz |
| LQW18AS3N6J00□ | 3.6nH ±5% | 250MHz | 22 | 250MHz | 700mA | 0.063Ω | 5900MHz |
| LQW18AS3N9G00□ | 3.9nH ±2% | 250MHz | 22 | 250MHz | 700mA | 0.080Ω | 6900MHz |
| LQW18AS3N9J00□ | 3.9nH ±5% | 250MHz | 22 | 250MHz | 700mA | 0.080Ω | 6900MHz |
| LQW18AS4N3G00□ | 4.3nH ±2% | 250MHz | 22 | 250MHz | 700mA | 0.063Ω | 5900MHz |
| LQW18AS4N3J00□ | 4.3nH ±5% | 250MHz | 22 | 250MHz | 700mA | 0.063Ω | 5900MHz |
| LQW18AS4N7G00□ | 4.7nH ±2% | 250MHz | 20 | 250MHz | 700mA | 0.116Ω | 5800MHz |
| LQW18AS4N7J00□ | 4.7nH ±5% | 250MHz | 20 | 250MHz | 700mA | 0.116Ω | 5800MHz |
| LQW18AS5N1G00□ | 5.1nH ±2% | 250MHz | 20 | 250MHz | 700mA | 0.140Ω | 5700MHz |
| LQW18AS5N1J00□ | 5.1nH ±5% | 250MHz | 20 | 250MHz | 700mA | 0.140Ω | 5700MHz |
| LQW18AS5N6G00□ | 5.6nH ±2% | 250MHz | 26 | 250MHz | 700mA | 0.075Ω | 4760MHz |
| LQW18AS5N6J00□ | 5.6nH ±5% | 250MHz | 26 | 250MHz | 700mA | 0.075Ω | 4760MHz |
| LQW18AS6N8G00□ | 6.8nH ±2% | 250MHz | 27 | 250MHz | 700mA | 0.110Ω | 5800MHz |
| LQW18AS6N8J00□ | 6.8nH ±5% | 250MHz | 27 | 250MHz | 700mA | 0.110Ω | 5800MHz |
| LQW18AS7N5G00□ | 7.5nH ±2% | 250MHz | 28 | 250MHz | 700mA | 0.106Ω | 4800MHz |
| LQW18AS7N5J00□ | 7.5nH ±5% | 250MHz | 28 | 250MHz | 700mA | 0.106Ω | 4800MHz |
| LQW18AS8N2G00□ | 8.2nH ±2% | 250MHz | 30 | 250MHz | 700mA | 0.115Ω | 4200MHz |
| LQW18AS8N2J00□ | 8.2nH ±5% | 250MHz | 30 | 250MHz | 700mA | 0.115Ω | 4200MHz |
| LQW18AS8N7G00□ | 8.7nH ±2% | 250MHz | 28 | 250MHz | 700mA | 0.109Ω | 4600MHz |
| LQW18AS8N7J00□ | 8.7nH ±5% | 250MHz | 28 | 250MHz | 700mA | 0.109Ω | 4600MHz |
| LQW18AS9N5G00□ | 9.5nH ±2% | 250MHz | 28 | 250MHz | 700mA | 0.135Ω | 5400MHz |
| LQW18AS9N5J00□ | 9.5nH ±5% | 250MHz | 28 | 250MHz | 700mA | 0.135Ω | 5400MHz |
| LQW18AS10NG00□ | 10nH ±2% | 250MHz | 31 | 250MHz | 700mA | 0.130Ω | 4800MHz |
| LQW18AS10NJ00□ | 10nH ±5% | 250MHz | 31 | 250MHz | 700mA | 0.130Ω | 4800MHz |
| LQW18AS11NG00□ | 11nH ±2% | 250MHz | 30 | 250MHz | 700mA | 0.086Ω | 4000MHz |
| LQW18AS11NJ00□ | 11nH ±5% | 250MHz | 30 | 250MHz | 700mA | 0.086Ω | 4000MHz |
| LQW18AS12NG00□ | 12nH ±2% | 250MHz | 35 | 250MHz | 700mA | 0.130Ω | 4000MHz |
| LQW18AS12NJ00□ | 12nH ±5% | 250MHz | 35 | 250MHz | 700mA | 0.130Ω | 4000MHz |
| LQW18AS15NG00□ | 15nH ±2% | 250MHz | 35 | 250MHz | 700mA | 0.170Ω | 4000MHz |
| LQW18AS15NJ00□ | 15nH ±5% | 250MHz | 35 | 250MHz | 700mA | 0.170Ω | 4000MHz |
| LQW18AS16NG00□ | 16nH ±2% | 250MHz | 34 | 250MHz | 700mA | 0.104Ω | 3300MHz |
| LQW18AS16NJ00□ | 16nH ±5% | 250MHz | 34 | 250MHz | 700mA | 0.104Ω | 3300MHz |
| LQW18AS18NG00□ | 18nH ±2% | 250MHz | 35 | 250MHz | 700mA | 0.170Ω | 3100MHz |
| LQW18AS18NJ00□ | 18nH ±5% | 250MHz | 35 | 250MHz | 700mA | 0.170Ω | 3100MHz |
| LQW18AS22NG00□ | 22nH ±2% | 250MHz | 38 | 250MHz | 700mA | 0.190Ω | 3000MHz |
| LQW18AS22NJ00□ | 22nH ±5% | 250MHz | 38 | 250MHz | 700mA | 0.190Ω | 3000MHz |

Operating temp. range (Self-temp. rise included): -40 to 125°C

Only for reflow soldering

*S.R.F.: Self Resonant Frequency

Continued on the following page. ↗

Continued from the preceding page. ↘

| Part Number (□: packaging code) | Inductance | Inductance Test Frequency | Q (min.) | Q Test Frequency | Rated Current | Max. of DC Resistance | S.R.F.* (min.) |
|------------------------------------|------------|------------------------------|----------|------------------|---------------|-----------------------|----------------|
| LQW18AS23NG00□ | 23nH ±2% | 250MHz | 38 | 250MHz | 700mA | 0.190Ω | 2850MHz |
| LQW18AS23NJ00□ | 23nH ±5% | 250MHz | 38 | 250MHz | 700mA | 0.190Ω | 2850MHz |
| LQW18AS24NG00□ | 24nH ±2% | 250MHz | 36 | 250MHz | 700mA | 0.135Ω | 2650MHz |
| LQW18AS24NJ00□ | 24nH ±5% | 250MHz | 36 | 250MHz | 700mA | 0.135Ω | 2650MHz |
| LQW18AS27NG00□ | 27nH ±2% | 250MHz | 40 | 250MHz | 600mA | 0.220Ω | 2800MHz |
| LQW18AS27NJ00□ | 27nH ±5% | 250MHz | 40 | 250MHz | 600mA | 0.220Ω | 2800MHz |
| LQW18AS30NG00□ | 30nH ±2% | 250MHz | 37 | 250MHz | 600mA | 0.144Ω | 2250MHz |
| LQW18AS30NJ00□ | 30nH ±5% | 250MHz | 37 | 250MHz | 600mA | 0.144Ω | 2250MHz |
| LQW18AS33NG00□ | 33nH ±2% | 250MHz | 40 | 250MHz | 600mA | 0.220Ω | 2300MHz |
| LQW18AS33NJ00□ | 33nH ±5% | 250MHz | 40 | 250MHz | 600mA | 0.220Ω | 2300MHz |
| LQW18AS36NG00□ | 36nH ±2% | 250MHz | 37 | 250MHz | 600mA | 0.250Ω | 2080MHz |
| LQW18AS36NJ00□ | 36nH ±5% | 250MHz | 37 | 250MHz | 600mA | 0.250Ω | 2080MHz |
| LQW18AS39NG00□ | 39nH ±2% | 250MHz | 40 | 250MHz | 600mA | 0.250Ω | 2200MHz |
| LQW18AS39NJ00□ | 39nH ±5% | 250MHz | 40 | 250MHz | 600mA | 0.250Ω | 2200MHz |
| LQW18AS43NG00□ | 43nH ±2% | 250MHz | 38 | 250MHz | 600mA | 0.280Ω | 2000MHz |
| LQW18AS43NJ00□ | 43nH ±5% | 250MHz | 38 | 250MHz | 600mA | 0.280Ω | 2000MHz |
| LQW18AS47NG00□ | 47nH ±2% | 200MHz | 38 | 200MHz | 600mA | 0.280Ω | 2000MHz |
| LQW18AS47NJ00□ | 47nH ±5% | 200MHz | 38 | 200MHz | 600mA | 0.280Ω | 2000MHz |
| LQW18AS51NG00□ | 51nH ±2% | 200MHz | 35 | 200MHz | 600mA | 0.270Ω | 1900MHz |
| LQW18AS51NJ00□ | 51nH ±5% | 200MHz | 35 | 200MHz | 600mA | 0.270Ω | 1900MHz |
| LQW18AS56NG00□ | 56nH ±2% | 200MHz | 38 | 200MHz | 600mA | 0.310Ω | 1900MHz |
| LQW18AS56NJ00□ | 56nH ±5% | 200MHz | 38 | 200MHz | 600mA | 0.310Ω | 1900MHz |
| LQW18AS68NG00□ | 68nH ±2% | 200MHz | 37 | 200MHz | 600mA | 0.340Ω | 1700MHz |
| LQW18AS68NJ00□ | 68nH ±5% | 200MHz | 37 | 200MHz | 600mA | 0.340Ω | 1700MHz |
| LQW18AS72NG00□ | 72nH ±2% | 150MHz | 34 | 150MHz | 400mA | 0.490Ω | 1700MHz |
| LQW18AS72NJ00□ | 72nH ±5% | 150MHz | 34 | 150MHz | 400mA | 0.490Ω | 1700MHz |
| LQW18AS82NG00□ | 82nH ±2% | 150MHz | 34 | 150MHz | 400mA | 0.540Ω | 1700MHz |
| LQW18AS82NJ00□ | 82nH ±5% | 150MHz | 34 | 150MHz | 400mA | 0.540Ω | 1700MHz |
| LQW18ASR10G00□ | 100nH ±2% | 150MHz | 34 | 150MHz | 400mA | 0.580Ω | 1400MHz |
| LQW18ASR10J00□ | 100nH ±5% | 150MHz | 34 | 150MHz | 400mA | 0.580Ω | 1400MHz |
| LQW18ASR11G00□ | 110nH ±2% | 150MHz | 32 | 150MHz | 300mA | 0.610Ω | 1350MHz |
| LQW18ASR11J00□ | 110nH ±5% | 150MHz | 32 | 150MHz | 300mA | 0.610Ω | 1350MHz |
| LQW18ASR12G00□ | 120nH ±2% | 150MHz | 32 | 150MHz | 300mA | 0.650Ω | 1300MHz |
| LQW18ASR12J00□ | 120nH ±5% | 150MHz | 32 | 150MHz | 300mA | 0.650Ω | 1300MHz |
| LQW18ASR15G00□ | 150nH ±2% | 150MHz | 28 | 150MHz | 280mA | 0.920Ω | 990MHz |
| LQW18ASR15J00□ | 150nH ±5% | 150MHz | 28 | 150MHz | 280mA | 0.920Ω | 990MHz |
| LQW18ASR18G00□ | 180nH ±2% | 100MHz | 25 | 100MHz | 240mA | 1.250Ω | 990MHz |
| LQW18ASR18J00□ | 180nH ±5% | 100MHz | 25 | 100MHz | 240mA | 1.250Ω | 990MHz |
| LQW18ASR20G00□ | 200nH ±2% | 100MHz | 25 | 100MHz | 200mA | 1.980Ω | 900MHz |
| LQW18ASR20J00□ | 200nH ±5% | 100MHz | 25 | 100MHz | 200mA | 1.980Ω | 900MHz |
| LQW18ASR21G00□ | 210nH ±2% | 100MHz | 27 | 100MHz | 200mA | 2.060Ω | 895MHz |
| LQW18ASR21J00□ | 210nH ±5% | 100MHz | 27 | 100MHz | 200mA | 2.060Ω | 895MHz |
| LQW18ASR22G00□ | 220nH ±2% | 100MHz | 25 | 100MHz | 200mA | 2.100Ω | 900MHz |
| LQW18ASR22J00□ | 220nH ±5% | 100MHz | 25 | 100MHz | 200mA | 2.100Ω | 900MHz |
| LQW18ASR25G00□ | 250nH ±2% | 100MHz | 25 | 100MHz | 120mA | 3.550Ω | 822MHz |
| LQW18ASR25J00□ | 250nH ±5% | 100MHz | 25 | 100MHz | 120mA | 3.550Ω | 822MHz |
| LQW18ASR27G00□ | 270nH ±2% | 100MHz | 24 | 100MHz | 170mA | 2.300Ω | 900MHz |
| LQW18ASR27J00□ | 270nH ±5% | 100MHz | 24 | 100MHz | 170mA | 2.300Ω | 900MHz |
| LQW18ASR33G00□ | 330nH ±2% | 100MHz | 25 | 100MHz | 100mA | 3.890Ω | 900MHz |
| LQW18ASR33J00□ | 330nH ±5% | 100MHz | 25 | 100MHz | 100mA | 3.890Ω | 900MHz |
| LQW18ASR39G00□ | 390nH ±2% | 100MHz | 25 | 100MHz | 100mA | 4.350Ω | 900MHz |
| LQW18ASR39J00□ | 390nH ±5% | 100MHz | 25 | 100MHz | 100mA | 4.350Ω | 900MHz |

Operating temp. range (Self-temp. rise included): -40 to 125°C

Only for reflow soldering

*S.R.F.: Self Resonant Frequency

Continued on the following page. ↗

Inductors for Power Lines

Inductors for General Circuits

RF Inductors
LQW18AS_00

Continued from the preceding page. ↘

Inductance-Frequency Characteristics (Typ.)



Q-Frequency Characteristics (Typ.)



LQW18AS_0C Series 0603 (1608) inch (mm)



| Packaging Code | Packaging | Minimum Quantity |
|----------------|---------------------|------------------|
| D | ø180mm Paper Taping | 4000 |
| J | ø330mm Paper Taping | 10000 |
| B | Packing in Bulk | 500 |

| Part Number (□: packaging code) | Inductance | Inductance Test Frequency | Q (min.) | Q Test Frequency | Rated Current | Max. of DC Resistance | S.R.F.* (min.) |
|------------------------------------|------------|---------------------------|----------|------------------|---------------|-----------------------|----------------|
| LQW18AS4N3G0C□ | 4.3nH ±2% | 250MHz | 22 | 250MHz | 700mA | 0.063Ω | 5900MHz |
| LQW18AS4N3J0C□ | 4.3nH ±5% | 250MHz | 22 | 250MHz | 700mA | 0.063Ω | 5900MHz |
| LQW18AS8N2G0C□ | 8.2nH ±2% | 250MHz | 30 | 250MHz | 700mA | 0.115Ω | 4200MHz |
| LQW18AS8N2J0C□ | 8.2nH ±5% | 250MHz | 30 | 250MHz | 700mA | 0.115Ω | 4200MHz |
| LQW18AS10NG0C□ | 10nH ±2% | 250MHz | 31 | 250MHz | 700mA | 0.13Ω | 4800MHz |
| LQW18AS10NJ0C□ | 10nH ±5% | 250MHz | 31 | 250MHz | 700mA | 0.13Ω | 4800MHz |
| LQW18AS11NG0C□ | 11nH ±2% | 250MHz | 30 | 250MHz | 700mA | 0.086Ω | 4000MHz |
| LQW18AS11NJ0C□ | 11nH ±5% | 250MHz | 30 | 250MHz | 700mA | 0.086Ω | 4000MHz |
| LQW18AS15NG0C□ | 15nH ±2% | 250MHz | 35 | 250MHz | 700mA | 0.17Ω | 4000MHz |
| LQW18AS15NJ0C□ | 15nH ±5% | 250MHz | 35 | 250MHz | 700mA | 0.17Ω | 4000MHz |
| LQW18AS16NG0C□ | 16nH ±2% | 250MHz | 34 | 250MHz | 700mA | 0.104Ω | 3300MHz |
| LQW18AS16NJ0C□ | 16nH ±5% | 250MHz | 34 | 250MHz | 700mA | 0.104Ω | 3300MHz |
| LQW18AS18NG0C□ | 18nH ±2% | 250MHz | 35 | 250MHz | 700mA | 0.17Ω | 3100MHz |
| LQW18AS18NJ0C□ | 18nH ±5% | 250MHz | 35 | 250MHz | 700mA | 0.17Ω | 3100MHz |
| LQW18AS22NG0C□ | 22nH ±2% | 250MHz | 38 | 250MHz | 700mA | 0.19Ω | 3000MHz |
| LQW18AS22NJ0C□ | 22nH ±5% | 250MHz | 38 | 250MHz | 700mA | 0.19Ω | 3000MHz |
| LQW18AS24NG0C□ | 24nH ±2% | 250MHz | 36 | 250MHz | 700mA | 0.135Ω | 2650MHz |
| LQW18AS24NJ0C□ | 24nH ±5% | 250MHz | 36 | 250MHz | 700mA | 0.135Ω | 2650MHz |
| LQW18AS33NG0C□ | 33nH ±2% | 250MHz | 40 | 250MHz | 600mA | 0.22Ω | 2300MHz |
| LQW18AS33NJ0C□ | 33nH ±5% | 250MHz | 40 | 250MHz | 600mA | 0.22Ω | 2300MHz |
| LQW18AS56NG0C□ | 56nH ±2% | 200MHz | 38 | 200MHz | 600mA | 0.31Ω | 1900MHz |
| LQW18AS56NJ0C□ | 56nH ±5% | 200MHz | 38 | 200MHz | 600mA | 0.31Ω | 1900MHz |
| LQW18AS68NG0C□ | 68nH ±2% | 200MHz | 37 | 200MHz | 600mA | 0.34Ω | 1700MHz |
| LQW18AS68NJ0C□ | 68nH ±5% | 200MHz | 37 | 200MHz | 600mA | 0.34Ω | 1700MHz |
| LQW18AS82NG0C□ | 82nH ±2% | 150MHz | 34 | 150MHz | 400mA | 0.54Ω | 1700MHz |
| LQW18AS82NJ0C□ | 82nH ±5% | 150MHz | 34 | 150MHz | 400mA | 0.54Ω | 1700MHz |

Operating temp. range (Self-temp. rise included): -40 to 85°C

Only for reflow soldering

*S.R.F.: Self Resonant Frequency

Continued on the following page. ↗

Continued from the preceding page. ↘

| Part Number (□: packaging code) | Inductance | Inductance Test Frequency | Q (min.) | Q Test Frequency | Rated Current | Max. of DC Resistance | S.R.F.* (min.) |
|------------------------------------|------------|---------------------------|----------|------------------|---------------|-----------------------|----------------|
| LQW18ASR10G0C□ | 100nH ±2% | 150MHz | 34 | 150MHz | 400mA | 0.58Ω | 1400MHz |
| LQW18ASR10J0C□ | 100nH ±5% | 150MHz | 34 | 150MHz | 400mA | 0.58Ω | 1400MHz |
| LQW18ASR12G0C□ | 120nH ±2% | 150MHz | 32 | 150MHz | 300mA | 0.65Ω | 1300MHz |
| LQW18ASR12J0C□ | 120nH ±5% | 150MHz | 32 | 150MHz | 300mA | 0.65Ω | 1300MHz |
| LQW18ASR15G0C□ | 150nH ±2% | 150MHz | 28 | 150MHz | 280mA | 0.92Ω | 990MHz |
| LQW18ASR15J0C□ | 150nH ±5% | 150MHz | 28 | 150MHz | 280mA | 0.92Ω | 990MHz |
| LQW18ASR18G0C□ | 180nH ±2% | 100MHz | 25 | 100MHz | 240mA | 1.4Ω | 990MHz |
| LQW18ASR18J0C□ | 180nH ±5% | 100MHz | 25 | 100MHz | 240mA | 1.4Ω | 990MHz |
| LQW18ASR22G0C□ | 220nH ±2% | 100MHz | 25 | 100MHz | 200mA | 2.1Ω | 900MHz |
| LQW18ASR22J0C□ | 220nH ±5% | 100MHz | 25 | 100MHz | 200mA | 2.1Ω | 900MHz |
| LQW18ASR27G0C□ | 270nH ±2% | 100MHz | 24 | 100MHz | 130mA | 2.5Ω | 900MHz |
| LQW18ASR27J0C□ | 270nH ±5% | 100MHz | 24 | 100MHz | 130mA | 2.5Ω | 900MHz |
| LQW18ASR33G0C□ | 330nH ±2% | 100MHz | 25 | 100MHz | 100mA | 3.89Ω | 900MHz |
| LQW18ASR33J0C□ | 330nH ±5% | 100MHz | 25 | 100MHz | 100mA | 3.89Ω | 900MHz |
| LQW18ASR39G0C□ | 390nH ±2% | 100MHz | 25 | 100MHz | 100mA | 4.35Ω | 900MHz |
| LQW18ASR39J0C□ | 390nH ±5% | 100MHz | 25 | 100MHz | 100mA | 4.35Ω | 900MHz |

Operating temp. range (Self-temp. rise included): -40 to 85°C

Only for reflow soldering

*S.R.F.: Self Resonant Frequency

Inductance-Frequency Characteristics (Typ.)



Q-Frequency Characteristics (Typ.)



LQW2BAN_00 Series 0805 (2015) inch (mm)



| Packaging Code | Packaging | Minimum Quantity |
|----------------|------------------------|------------------|
| K | ø330mm Embossed Taping | 8000 |
| L | ø180mm Embossed Taping | 2000 |
| B | Packing in Bulk | 500 |

Continued on the following page. ↗

Continued from the preceding page. ↘

| Part Number (□: packaging code) | Inductance | Inductance Test Frequency | Q (min.) | Q Test Frequency | Rated Current | Max. of DC Resistance | S.R.F.* (min.) |
|------------------------------------|------------|------------------------------|----------|------------------|---------------|-----------------------|----------------|
| LQW2BAN3N2J00□ | 3.2nH ±5% | 250MHz | 95 | 1500MHz | 3800mA | 0.02Ω | 13800MHz |
| LQW2BAN3N6J00□ | 3.6nH ±5% | 250MHz | 75 | 1500MHz | 2000mA | 0.05Ω | 11800MHz |
| LQW2BAN6N8J00□ | 6.8nH ±5% | 250MHz | 90 | 1000MHz | 3000mA | 0.03Ω | 6200MHz |
| LQW2BAN7N5J00□ | 7.5nH ±5% | 250MHz | 85 | 1000MHz | 2400mA | 0.04Ω | 3900MHz |
| LQW2BAN8N2G00□ | 8.2nH ±2% | 250MHz | 80 | 1000MHz | 1500mA | 0.09Ω | 3200MHz |
| LQW2BAN8N2J00□ | 8.2nH ±5% | 250MHz | 80 | 1000MHz | 1500mA | 0.09Ω | 3200MHz |
| LQW2BAN11NG00□ | 11nH ±2% | 250MHz | 80 | 500MHz | 2400mA | 0.04Ω | 4700MHz |
| LQW2BAN11NJ00□ | 11nH ±5% | 250MHz | 80 | 500MHz | 2400mA | 0.04Ω | 4700MHz |
| LQW2BAN12NG00□ | 12nH ±2% | 250MHz | 80 | 500MHz | 2400mA | 0.04Ω | 4300MHz |
| LQW2BAN12NJ00□ | 12nH ±5% | 250MHz | 80 | 500MHz | 2400mA | 0.04Ω | 4300MHz |
| LQW2BAN13NG00□ | 13nH ±2% | 250MHz | 80 | 500MHz | 2400mA | 0.04Ω | 3500MHz |
| LQW2BAN13NJ00□ | 13nH ±5% | 250MHz | 80 | 500MHz | 2400mA | 0.04Ω | 3500MHz |
| LQW2BAN15NG00□ | 15nH ±2% | 250MHz | 70 | 500MHz | 1500mA | 0.12Ω | 1940MHz |
| LQW2BAN15NJ00□ | 15nH ±5% | 250MHz | 70 | 500MHz | 1500mA | 0.12Ω | 1940MHz |
| LQW2BAN18NG00□ | 18nH ±2% | 250MHz | 85 | 500MHz | 2200mA | 0.05Ω | 3620MHz |
| LQW2BAN18NJ00□ | 18nH ±5% | 250MHz | 85 | 500MHz | 2200mA | 0.05Ω | 3620MHz |
| LQW2BAN20NG00□ | 20nH ±2% | 250MHz | 85 | 500MHz | 2200mA | 0.05Ω | 2960MHz |
| LQW2BAN20NJ00□ | 20nH ±5% | 250MHz | 85 | 500MHz | 2200mA | 0.05Ω | 2960MHz |
| LQW2BAN22NG00□ | 22nH ±2% | 250MHz | 85 | 500MHz | 1900mA | 0.07Ω | 1850MHz |
| LQW2BAN22NJ00□ | 22nH ±5% | 250MHz | 85 | 500MHz | 1900mA | 0.07Ω | 1850MHz |
| LQW2BAN24NG00□ | 24nH ±2% | 250MHz | 75 | 500MHz | 1400mA | 0.15Ω | 1970MHz |
| LQW2BAN24NJ00□ | 24nH ±5% | 250MHz | 75 | 500MHz | 1400mA | 0.15Ω | 1970MHz |
| LQW2BAN27NG00□ | 27nH ±2% | 250MHz | 85 | 500MHz | 2000mA | 0.07Ω | 2750MHz |
| LQW2BAN27NJ00□ | 27nH ±5% | 250MHz | 85 | 500MHz | 2000mA | 0.07Ω | 2750MHz |
| LQW2BAN30NG00□ | 30nH ±2% | 250MHz | 80 | 500MHz | 2000mA | 0.08Ω | 2000MHz |
| LQW2BAN30NJ00□ | 30nH ±5% | 250MHz | 80 | 500MHz | 2000mA | 0.08Ω | 2000MHz |
| LQW2BAN33NG00□ | 33nH ±2% | 250MHz | 75 | 500MHz | 1500mA | 0.12Ω | 1900MHz |
| LQW2BAN33NJ00□ | 33nH ±5% | 250MHz | 75 | 500MHz | 1500mA | 0.12Ω | 1900MHz |
| LQW2BAN36NG00□ | 36nH ±2% | 250MHz | 75 | 500MHz | 1900mA | 0.08Ω | 1900MHz |
| LQW2BAN36NJ00□ | 36nH ±5% | 250MHz | 75 | 500MHz | 1900mA | 0.08Ω | 1900MHz |
| LQW2BAN39NG00□ | 39nH ±2% | 250MHz | 75 | 500MHz | 1900mA | 0.08Ω | 1900MHz |
| LQW2BAN39NJ00□ | 39nH ±5% | 250MHz | 75 | 500MHz | 1900mA | 0.08Ω | 1900MHz |
| LQW2BAN43NG00□ | 43nH ±2% | 200MHz | 75 | 500MHz | 1550mA | 0.12Ω | 1720MHz |
| LQW2BAN43NJ00□ | 43nH ±5% | 200MHz | 75 | 500MHz | 1550mA | 0.12Ω | 1720MHz |
| LQW2BAN47NG00□ | 47nH ±2% | 200MHz | 70 | 500MHz | 1250mA | 0.20Ω | 1500MHz |
| LQW2BAN47NJ00□ | 47nH ±5% | 200MHz | 70 | 500MHz | 1250mA | 0.20Ω | 1500MHz |
| LQW2BAN51NG00□ | 51nH ±2% | 200MHz | 75 | 500MHz | 1800mA | 0.11Ω | 1100MHz |
| LQW2BAN51NJ00□ | 51nH ±5% | 200MHz | 75 | 500MHz | 1800mA | 0.11Ω | 1100MHz |
| LQW2BAN56NG00□ | 56nH ±2% | 200MHz | 70 | 500MHz | 1250mA | 0.18Ω | 1600MHz |
| LQW2BAN56NJ00□ | 56nH ±5% | 200MHz | 70 | 500MHz | 1250mA | 0.18Ω | 1600MHz |
| LQW2BAN62NG00□ | 62nH ±2% | 200MHz | 70 | 500MHz | 1650mA | 0.12Ω | 1470MHz |
| LQW2BAN62NJ00□ | 62nH ±5% | 200MHz | 70 | 500MHz | 1650mA | 0.12Ω | 1470MHz |
| LQW2BAN68NG00□ | 68nH ±2% | 200MHz | 70 | 500MHz | 1250mA | 0.2Ω | 1470MHz |
| LQW2BAN68NJ00□ | 68nH ±5% | 200MHz | 70 | 500MHz | 1250mA | 0.2Ω | 1470MHz |
| LQW2BAN75NG00□ | 75nH ±2% | 200MHz | 68 | 500MHz | 1100mA | 0.28Ω | 1450MHz |
| LQW2BAN75NJ00□ | 75nH ±5% | 200MHz | 68 | 500MHz | 1100mA | 0.28Ω | 1450MHz |
| LQW2BAN82NG00□ | 82nH ±2% | 150MHz | 70 | 500MHz | 1200mA | 0.24Ω | 1330MHz |
| LQW2BAN82NJ00□ | 82nH ±5% | 150MHz | 70 | 500MHz | 1200mA | 0.24Ω | 1330MHz |
| LQW2BAN91NG00□ | 91nH ±2% | 150MHz | 70 | 500MHz | 1300mA | 0.21Ω | 1140MHz |
| LQW2BAN91NJ00□ | 91nH ±5% | 150MHz | 70 | 500MHz | 1300mA | 0.21Ω | 1140MHz |
| LQW2BANR10G00□ | 100nH ±2% | 150MHz | 66 | 500MHz | 1050mA | 0.35Ω | 1200MHz |

Operating temp. range (Self-temp. rise included): -55 to 125°C

Only for reflow soldering

*S.R.F.: Self Resonant Frequency

In operating temperatures exceeding +85°C, derating of current is necessary for the LQW2BAN_00 series. Please apply the derating curve shown in the chart according to the operating temperature. When rated current is applied to the products, self-temperature rise shall be limited to 40°C max. Please consider "Notice (Rating)."

Continued on the following page. ↗

Continued from the preceding page. ↘

| Part Number (□: packaging code) | Inductance | Inductance Test Frequency | Q (min.) | Q Test Frequency | Rated Current | Max. of DC Resistance | S.R.F.* (min.) |
|------------------------------------|------------|---------------------------|----------|------------------|---------------|-----------------------|----------------|
| LQW2BANR10J00□ | 100nH ±5% | 150MHz | 66 | 500MHz | 1050mA | 0.35Ω | 1200MHz |
| LQW2BANR11G00□ | 110nH ±2% | 150MHz | 57 | 250MHz | 970mA | 0.38Ω | 1200MHz |
| LQW2BANR11J00□ | 110nH ±5% | 150MHz | 57 | 250MHz | 970mA | 0.38Ω | 1200MHz |
| LQW2BANR12G00□ | 120nH ±2% | 150MHz | 57 | 250MHz | 970mA | 0.38Ω | 1200MHz |
| LQW2BANR12J00□ | 120nH ±5% | 150MHz | 57 | 250MHz | 970mA | 0.38Ω | 1200MHz |
| LQW2BANR13G00□ | 130nH ±2% | 150MHz | 56 | 250MHz | 950mA | 0.42Ω | 1000MHz |
| LQW2BANR13J00□ | 130nH ±5% | 150MHz | 56 | 250MHz | 950mA | 0.42Ω | 1000MHz |
| LQW2BANR15G00□ | 150nH ±2% | 100MHz | 58 | 250MHz | 930mA | 0.46Ω | 920MHz |
| LQW2BANR15J00□ | 150nH ±5% | 100MHz | 58 | 250MHz | 930mA | 0.46Ω | 920MHz |
| LQW2BANR16G00□ | 160nH ±2% | 100MHz | 53 | 250MHz | 930mA | 0.46Ω | 920MHz |
| LQW2BANR16J00□ | 160nH ±5% | 100MHz | 53 | 250MHz | 930mA | 0.46Ω | 920MHz |
| LQW2BANR18G00□ | 180nH ±2% | 100MHz | 53 | 250MHz | 800mA | 0.58Ω | 920MHz |
| LQW2BANR18J00□ | 180nH ±5% | 100MHz | 53 | 250MHz | 800mA | 0.58Ω | 920MHz |
| LQW2BANR20G00□ | 200nH ±2% | 100MHz | 53 | 250MHz | 750mA | 0.63Ω | 920MHz |
| LQW2BANR20J00□ | 200nH ±5% | 100MHz | 53 | 250MHz | 750mA | 0.63Ω | 920MHz |

Operating temp. range (Self-temp. rise included): -55 to 125°C

Only for reflow soldering

*S.R.F.: Self Resonant Frequency

In operating temperatures exceeding +85°C, derating of current is necessary for the LQW2BAN_00 series. Please apply the derating curve shown in the chart according to the operating temperature. When rated current is applied to the products, self-temperature rise shall be limited to 40°C max. Please consider "Notice (Rating)."

Inductance-Frequency Characteristics (Typ.)



Q-Frequency Characteristics (Typ.)



Notice (Rating)

In operating temperatures exceeding +85°C, derating of current is necessary for this series. Please apply the derating curve shown in the chart according to the operating temperature.

Derating of Rated Current



LQW2BAS_00 Series 0805 (2015) inch (mm)



| Packaging Code | Packaging | Minimum Quantity |
|----------------|------------------------|------------------|
| K | ø330mm Embossed Taping | 8000 |
| L | ø180mm Embossed Taping | 2000 |
| B | Packing in Bulk | 500 |

Continued on the following page. ↗

Continued from the preceding page. ↘

| Part Number (□: packaging code) | Inductance | Inductance Test Frequency | Q (min.) | Q Test Frequency | Rated Current | Max. of DC Resistance | S.R.F.* (min.) |
|------------------------------------|------------|------------------------------|----------|------------------|---------------|-----------------------|----------------|
| LQW2BAS2N7J00□ | 2.7nH ±5% | 250MHz | 80 | 1500MHz | 910mA | 0.03Ω | 15000MHz |
| LQW2BAS2N8J00□ | 2.8nH ±5% | 250MHz | 80 | 1500MHz | 800mA | 0.06Ω | 12200MHz |
| LQW2BAS3N0J00□ | 3.0nH ±5% | 250MHz | 65 | 1500MHz | 800mA | 0.06Ω | 12200MHz |
| LQW2BAS5N6J00□ | 5.6nH ±5% | 250MHz | 65 | 1000MHz | 600mA | 0.08Ω | 5900MHz |
| LQW2BAS6N0J00□ | 6.0nH ±5% | 250MHz | 70 | 1000MHz | 600mA | 0.03Ω | 4500MHz |
| LQW2BAS6N8J00□ | 6.8nH ±5% | 250MHz | 50 | 1000MHz | 600mA | 0.11Ω | 5600MHz |
| LQW2BAS7N5J00□ | 7.5nH ±5% | 250MHz | 50 | 1000MHz | 600mA | 0.14Ω | 4800MHz |
| LQW2BAS8N2G00□ | 8.2nH ±2% | 250MHz | 50 | 1000MHz | 600mA | 0.12Ω | 4400MHz |
| LQW2BAS8N2J00□ | 8.2nH ±5% | 250MHz | 50 | 1000MHz | 600mA | 0.12Ω | 4400MHz |
| LQW2BAS10NG00□ | 10nH ±2% | 250MHz | 60 | 500MHz | 600mA | 0.10Ω | 4300MHz |
| LQW2BAS10NJ00□ | 10nH ±5% | 250MHz | 60 | 500MHz | 600mA | 0.10Ω | 4300MHz |
| LQW2BAS12NG00□ | 12nH ±2% | 250MHz | 50 | 500MHz | 600mA | 0.15Ω | 4000MHz |
| LQW2BAS12NJ00□ | 12nH ±5% | 250MHz | 50 | 500MHz | 600mA | 0.15Ω | 4000MHz |
| LQW2BAS15NG00□ | 15nH ±2% | 250MHz | 50 | 500MHz | 600mA | 0.17Ω | 3200MHz |
| LQW2BAS15NJ00□ | 15nH ±5% | 250MHz | 50 | 500MHz | 600mA | 0.17Ω | 3200MHz |
| LQW2BAS18NG00□ | 18nH ±2% | 250MHz | 50 | 500MHz | 600mA | 0.20Ω | 3100MHz |
| LQW2BAS18NJ00□ | 18nH ±5% | 250MHz | 50 | 500MHz | 600mA | 0.20Ω | 3100MHz |
| LQW2BAS22NG00□ | 22nH ±2% | 250MHz | 55 | 500MHz | 500mA | 0.22Ω | 2600MHz |
| LQW2BAS22NJ00□ | 22nH ±5% | 250MHz | 55 | 500MHz | 500mA | 0.22Ω | 2600MHz |
| LQW2BAS24NG00□ | 24nH ±2% | 250MHz | 50 | 500MHz | 500mA | 0.22Ω | 2400MHz |
| LQW2BAS24NJ00□ | 24nH ±5% | 250MHz | 50 | 500MHz | 500mA | 0.22Ω | 2400MHz |
| LQW2BAS27NG00□ | 27nH ±2% | 250MHz | 55 | 500MHz | 500mA | 0.25Ω | 2580MHz |
| LQW2BAS27NJ00□ | 27nH ±5% | 250MHz | 55 | 500MHz | 500mA | 0.25Ω | 2580MHz |
| LQW2BAS33NG00□ | 33nH ±2% | 250MHz | 60 | 500MHz | 500mA | 0.27Ω | 2150MHz |
| LQW2BAS33NJ00□ | 33nH ±5% | 250MHz | 60 | 500MHz | 500mA | 0.27Ω | 2150MHz |
| LQW2BAS36NG00□ | 36nH ±2% | 250MHz | 55 | 500MHz | 500mA | 0.27Ω | 1900MHz |
| LQW2BAS36NJ00□ | 36nH ±5% | 250MHz | 55 | 500MHz | 500mA | 0.27Ω | 1900MHz |
| LQW2BAS39NG00□ | 39nH ±2% | 250MHz | 60 | 500MHz | 500mA | 0.29Ω | 2000MHz |
| LQW2BAS39NJ00□ | 39nH ±5% | 250MHz | 60 | 500MHz | 500mA | 0.29Ω | 2000MHz |
| LQW2BAS43NG00□ | 43nH ±2% | 200MHz | 60 | 500MHz | 500mA | 0.34Ω | 1800MHz |
| LQW2BAS43NJ00□ | 43nH ±5% | 200MHz | 60 | 500MHz | 500mA | 0.34Ω | 1800MHz |
| LQW2BAS47NG00□ | 47nH ±2% | 200MHz | 60 | 500MHz | 500mA | 0.31Ω | 1700MHz |
| LQW2BAS47NJ00□ | 47nH ±5% | 200MHz | 60 | 500MHz | 500mA | 0.31Ω | 1700MHz |
| LQW2BAS56NG00□ | 56nH ±2% | 200MHz | 60 | 500MHz | 500mA | 0.34Ω | 1600MHz |
| LQW2BAS56NJ00□ | 56nH ±5% | 200MHz | 60 | 500MHz | 500mA | 0.34Ω | 1600MHz |
| LQW2BAS68NG00□ | 68nH ±2% | 200MHz | 60 | 500MHz | 500mA | 0.38Ω | 1500MHz |
| LQW2BAS68NJ00□ | 68nH ±5% | 200MHz | 60 | 500MHz | 500mA | 0.38Ω | 1500MHz |
| LQW2BAS82NG00□ | 82nH ±2% | 150MHz | 65 | 500MHz | 400mA | 0.42Ω | 1330MHz |
| LQW2BAS82NJ00□ | 82nH ±5% | 150MHz | 65 | 500MHz | 400mA | 0.42Ω | 1330MHz |
| LQW2BAS91NG00□ | 91nH ±2% | 150MHz | 65 | 500MHz | 400mA | 0.48Ω | 1330MHz |
| LQW2BAS91NJ00□ | 91nH ±5% | 150MHz | 65 | 500MHz | 400mA | 0.48Ω | 1330MHz |
| LQW2BASR10G00□ | 100nH ±2% | 150MHz | 65 | 500MHz | 400mA | 0.46Ω | 1250MHz |
| LQW2BASR10J00□ | 100nH ±5% | 150MHz | 65 | 500MHz | 400mA | 0.46Ω | 1250MHz |
| LQW2BASR11G00□ | 110nH ±2% | 150MHz | 50 | 250MHz | 400mA | 0.48Ω | 1100MHz |
| LQW2BASR11J00□ | 110nH ±5% | 150MHz | 50 | 250MHz | 400mA | 0.48Ω | 1100MHz |
| LQW2BASR12G00□ | 120nH ±2% | 150MHz | 50 | 250MHz | 400mA | 0.51Ω | 1100MHz |
| LQW2BASR12J00□ | 120nH ±5% | 150MHz | 50 | 250MHz | 400mA | 0.51Ω | 1100MHz |
| LQW2BASR15G00□ | 150nH ±2% | 100MHz | 50 | 250MHz | 400mA | 0.56Ω | 920MHz |
| LQW2BASR15J00□ | 150nH ±5% | 100MHz | 50 | 250MHz | 400mA | 0.56Ω | 920MHz |
| LQW2BASR18G00□ | 180nH ±2% | 100MHz | 50 | 250MHz | 400mA | 0.64Ω | 920MHz |
| LQW2BASR18J00□ | 180nH ±5% | 100MHz | 50 | 250MHz | 400mA | 0.64Ω | 920MHz |
| LQW2BASR22G00□ | 220nH ±2% | 100MHz | 50 | 250MHz | 400mA | 0.70Ω | 820MHz |
| LQW2BASR22J00□ | 220nH ±5% | 100MHz | 50 | 250MHz | 400mA | 0.70Ω | 820MHz |

Operating temp. range: -55 to 125°C
 Only for reflow soldering
 *S.R.F.: Self Resonant Frequency

Continued on the following page. ↗

Continued from the preceding page. ↘

| Part Number (□: packaging code) | Inductance | Inductance Test Frequency | Q (min.) | Q Test Frequency | Rated Current | Max. of DC Resistance | S.R.F.* (min.) |
|------------------------------------|------------|---------------------------|----------|------------------|---------------|-----------------------|----------------|
| LQW2BASR24G00□ | 240nH ±2% | 100MHz | 44 | 250MHz | 350mA | 1.00Ω | 770MHz |
| LQW2BASR24J00□ | 240nH ±5% | 100MHz | 44 | 250MHz | 350mA | 1.00Ω | 770MHz |
| LQW2BASR27G00□ | 270nH ±2% | 100MHz | 48 | 250MHz | 350mA | 1.00Ω | 730MHz |
| LQW2BASR27J00□ | 270nH ±5% | 100MHz | 48 | 250MHz | 350mA | 1.00Ω | 730MHz |
| LQW2BASR33G00□ | 330nH ±2% | 100MHz | 48 | 250MHz | 310mA | 1.40Ω | 650MHz |
| LQW2BASR33J00□ | 330nH ±5% | 100MHz | 48 | 250MHz | 310mA | 1.40Ω | 650MHz |
| LQW2BASR39J00□ | 390nH ±5% | 100MHz | 48 | 250MHz | 290mA | 1.50Ω | 600MHz |
| LQW2BASR47J00□ | 470nH ±5% | 50MHz | 33 | 100MHz | 250mA | 1.76Ω | 300MHz |
| LQW2BASR56J00□ | 560nH ±5% | 25MHz | 23 | 50MHz | 230mA | 1.90Ω | 270MHz |
| LQW2BASR68J00□ | 680nH ±5% | 25MHz | 23 | 50MHz | 190mA | 2.20Ω | 250MHz |
| LQW2BASR82J00□ | 820nH ±5% | 25MHz | 23 | 50MHz | 180mA | 2.35Ω | 230MHz |
| LQW2BAS1R0J00□ | 1000nH ±5% | 25MHz | 23 | 50MHz | 170mA | 2.4Ω | 200MHz |

Operating temp. range: -55 to 125°C

Only for reflow soldering

*S.R.F.: Self Resonant Frequency

Inductance-Frequency Characteristics (Typ.)



Q-Frequency Characteristics (Typ.)



LQW2BHN_03 Series 0805 (2015) inch (mm)



| Packaging Code | Packaging | Minimum Quantity |
|----------------|------------------------|------------------|
| K | ø330mm Embossed Taping | 7500 |
| L | ø180mm Embossed Taping | 2000 |

| Part Number (□: packaging code) | Inductance | Inductance Test Frequency | Q (min.) | Q Test Frequency | Rated Current | Max. of DC Resistance | S.R.F.* (min.) |
|------------------------------------|--------------|---------------------------|----------|------------------|---------------|-----------------------|----------------|
| LQW2BHN3N3D03□ | 3.3nH ±0.5nH | 100MHz | 10 | 250MHz | 910mA | 0.05Ω | 6000MHz |
| LQW2BHN6N8D03□ | 6.8nH ±0.5nH | 100MHz | 20 | 250MHz | 680mA | 0.11Ω | 5400MHz |
| LQW2BHN8N2D03□ | 8.2nH ±0.5nH | 100MHz | 20 | 250MHz | 630mA | 0.12Ω | 3900MHz |
| LQW2BHN10NJ03□ | 10nH ±5% | 100MHz | 30 | 250MHz | 1320mA | 0.03Ω | 3300MHz |
| LQW2BHN12NJ03□ | 12nH ±5% | 100MHz | 30 | 250MHz | 680mA | 0.11Ω | 3200MHz |
| LQW2BHN15NJ03□ | 15nH ±5% | 100MHz | 30 | 250MHz | 630mA | 0.12Ω | 2700MHz |
| LQW2BHN18NJ03□ | 18nH ±5% | 100MHz | 30 | 250MHz | 690mA | 0.10Ω | 2600MHz |
| LQW2BHN22NJ03□ | 22nH ±5% | 100MHz | 30 | 250MHz | 720mA | 0.09Ω | 2100MHz |
| LQW2BHN27NJ03□ | 27nH ±5% | 100MHz | 40 | 250MHz | 540mA | 0.17Ω | 2300MHz |

Operating temp. range: -40 to 85°C

*S.R.F.: Self Resonant Frequency

Continued on the following page. ↗

Continued from the preceding page. ↘

| Part Number (□: packaging code) | Inductance | Inductance Test Frequency | Q (min.) | Q Test Frequency | Rated Current | Max. of DC Resistance | S.R.F.* (min.) |
|------------------------------------|------------|---------------------------|----------|------------------|---------------|-----------------------|----------------|
| LQW2BHN33NG03□ | 33nH ±2% | 100MHz | 40 | 250MHz | 570mA | 0.15Ω | 1900MHz |
| LQW2BHN33NJ03□ | 33nH ±5% | 100MHz | 40 | 250MHz | 570mA | 0.15Ω | 1900MHz |
| LQW2BHN39NG03□ | 39nH ±2% | 100MHz | 40 | 250MHz | 730mA | 0.09Ω | 1700MHz |
| LQW2BHN39NJ03□ | 39nH ±5% | 100MHz | 40 | 250MHz | 730mA | 0.09Ω | 1700MHz |
| LQW2BHN47NG03□ | 47nH ±2% | 100MHz | 40 | 200MHz | 450mA | 0.23Ω | 1600MHz |
| LQW2BHN47NJ03□ | 47nH ±5% | 100MHz | 40 | 200MHz | 450mA | 0.23Ω | 1600MHz |
| LQW2BHN56NG03□ | 56nH ±2% | 100MHz | 40 | 200MHz | 430mA | 0.26Ω | 1500MHz |
| LQW2BHN56NJ03□ | 56nH ±5% | 100MHz | 40 | 200MHz | 430mA | 0.26Ω | 1500MHz |
| LQW2BHN68NG03□ | 68nH ±2% | 100MHz | 40 | 200MHz | 460mA | 0.23Ω | 1200MHz |
| LQW2BHN68NJ03□ | 68nH ±5% | 100MHz | 40 | 200MHz | 460mA | 0.23Ω | 1200MHz |
| LQW2BHN82NG03□ | 82nH ±2% | 100MHz | 40 | 150MHz | 320mA | 0.42Ω | 1100MHz |
| LQW2BHN82NJ03□ | 82nH ±5% | 100MHz | 40 | 150MHz | 320mA | 0.42Ω | 1100MHz |
| LQW2BHNR10G03□ | 100nH ±2% | 100MHz | 35 | 150MHz | 270mA | 0.55Ω | 900MHz |
| LQW2BHNR10J03□ | 100nH ±5% | 100MHz | 40 | 150MHz | 350mA | 0.38Ω | 900MHz |
| LQW2BHNR12G03□ | 120nH ±2% | 100MHz | 40 | 150MHz | 320mA | 0.40Ω | 750MHz |
| LQW2BHNR12J03□ | 120nH ±5% | 100MHz | 40 | 150MHz | 320mA | 0.40Ω | 750MHz |
| LQW2BHNR15G03□ | 150nH ±2% | 100MHz | 30 | 150MHz | 260mA | 0.68Ω | 350MHz |
| LQW2BHNR15J03□ | 150nH ±5% | 100MHz | 30 | 150MHz | 390mA | 0.47Ω | 350MHz |
| LQW2BHNR18G03□ | 180nH ±2% | 100MHz | 35 | 100MHz | 250mA | 0.71Ω | 700MHz |
| LQW2BHNR18J03□ | 180nH ±5% | 100MHz | 35 | 100MHz | 250mA | 0.71Ω | 700MHz |
| LQW2BHNR22G03□ | 220nH ±2% | 100MHz | 35 | 100MHz | 240mA | 0.70Ω | 500MHz |
| LQW2BHNR22J03□ | 220nH ±5% | 100MHz | 35 | 100MHz | 240mA | 0.70Ω | 500MHz |
| LQW2BHNR27J03□ | 270nH ±5% | 10MHz | 15 | 25.2MHz | 190mA | 2.00Ω | 550MHz |
| LQW2BHNR27K03□ | 270nH ±10% | 10MHz | 15 | 25.2MHz | 190mA | 2.00Ω | 550MHz |
| LQW2BHNR33J03□ | 330nH ±5% | 10MHz | 15 | 25.2MHz | 180mA | 2.20Ω | 500MHz |
| LQW2BHNR33K03□ | 330nH ±10% | 10MHz | 15 | 25.2MHz | 180mA | 2.20Ω | 500MHz |
| LQW2BHNR39J03□ | 390nH ±5% | 10MHz | 15 | 25.2MHz | 170mA | 2.50Ω | 400MHz |
| LQW2BHNR39K03□ | 390nH ±10% | 10MHz | 15 | 25.2MHz | 170mA | 2.50Ω | 400MHz |
| LQW2BHNR47J03□ | 470nH ±5% | 10MHz | 15 | 25.2MHz | 160mA | 2.80Ω | 350MHz |
| LQW2BHNR47K03□ | 470nH ±10% | 10MHz | 15 | 25.2MHz | 160mA | 2.80Ω | 350MHz |

Operating temp. range: -40 to 85°C

*S.R.F.: Self Resonant Frequency

Inductance-Frequency Characteristics (Typ.)



Q-Frequency Characteristics (Typ.)



LQW2BHN_13 Series 0805 (2015) inch (mm)



| Packaging Code | Packaging | Minimum Quantity |
|----------------|------------------------|------------------|
| K | ø330mm Embossed Taping | 7500 |
| L | ø180mm Embossed Taping | 2000 |

| Part Number (□: packaging code) | Inductance | Inductance Test Frequency | Q (min.) | Q Test Frequency | Rated Current | Max. of DC Resistance | S.R.F.* (min.) |
|------------------------------------|--------------|---------------------------|----------|------------------|---------------|-----------------------|----------------|
| LQW2BHN2N7D13□ | 2.7nH ±0.5nH | 100MHz | 20 | 250MHz | 1900mA | 0.02Ω | 6000MHz |
| LQW2BHN3N1D13□ | 3.1nH ±0.5nH | 100MHz | 20 | 250MHz | 1800mA | 0.02Ω | 6000MHz |
| LQW2BHN3N3D13□ | 3.3nH ±0.5nH | 100MHz | 20 | 250MHz | 1700mA | 0.02Ω | 6000MHz |
| LQW2BHN5N6D13□ | 5.6nH ±0.5nH | 100MHz | 35 | 250MHz | 1500mA | 0.02Ω | 6000MHz |
| LQW2BHN6N8D13□ | 6.8nH ±0.5nH | 100MHz | 35 | 250MHz | 1400mA | 0.02Ω | 5400MHz |
| LQW2BHN8N6D13□ | 8.6nH ±0.5nH | 100MHz | 35 | 250MHz | 1300mA | 0.03Ω | 3900MHz |
| LQW2BHN10NJ13□ | 10nH ±5% | 100MHz | 35 | 250MHz | 1320mA | 0.03Ω | 3300MHz |
| LQW2BHN12NK13□ | 12nH ±10% | 100MHz | 40 | 250MHz | 1100mA | 0.04Ω | 3200MHz |
| LQW2BHN15NK13□ | 15nH ±10% | 100MHz | 40 | 250MHz | 1000mA | 0.04Ω | 3100MHz |
| LQW2BHN18NK13□ | 18.8nH ±10% | 100MHz | 40 | 250MHz | 1000mA | 0.05Ω | 2600MHz |
| LQW2BHN21NK13□ | 21nH ±10% | 100MHz | 40 | 250MHz | 950mA | 0.05Ω | 2200MHz |
| LQW2BHN27NK13□ | 27nH ±10% | 100MHz | 40 | 250MHz | 900mA | 0.06Ω | 1800MHz |

Operating temp. range: -40 to 85°C

*S.R.F.: Self Resonant Frequency

Inductance-Frequency Characteristics (Typ.)



Q-Frequency Characteristics (Typ.)



LQW2UAS_00 Series 1008 (2520) inch (mm)



| Packaging Code | Packaging | Minimum Quantity |
|----------------|------------------------|------------------|
| L | ø180mm Embossed Taping | 2000 |
| B | Packing in Bulk | 500 |

Continued on the following page. ↗

Continued from the preceding page. ↘

| Part Number (□: packaging code) | Inductance | Inductance Test Frequency | Q (min.) | Q Test Frequency | Rated Current | Max. of DC Resistance | S.R.F.* (min.) |
|------------------------------------|------------|------------------------------|----------|------------------|---------------|-----------------------|----------------|
| LQW2UAS12NG00□ | 12nH ±2% | 50MHz | 50 | 500MHz | 1000mA | 0.09Ω | 3300MHz |
| LQW2UAS12NJ00□ | 12nH ±5% | 50MHz | 50 | 500MHz | 1000mA | 0.09Ω | 3300MHz |
| LQW2UAS18NG00□ | 18nH ±2% | 50MHz | 50 | 350MHz | 1000mA | 0.11Ω | 2500MHz |
| LQW2UAS18NJ00□ | 18nH ±5% | 50MHz | 50 | 350MHz | 1000mA | 0.11Ω | 2500MHz |
| LQW2UAS22NF00□ | 22nH ±1% | 50MHz | 55 | 350MHz | 1000mA | 0.12Ω | 2400MHz |
| LQW2UAS22NG00□ | 22nH ±2% | 50MHz | 55 | 350MHz | 1000mA | 0.12Ω | 2400MHz |
| LQW2UAS22NJ00□ | 22nH ±5% | 50MHz | 55 | 350MHz | 1000mA | 0.12Ω | 2400MHz |
| LQW2UAS27NG00□ | 27nH ±2% | 50MHz | 55 | 350MHz | 1000mA | 0.13Ω | 1600MHz |
| LQW2UAS27NJ00□ | 27nH ±5% | 50MHz | 55 | 350MHz | 1000mA | 0.13Ω | 1600MHz |
| LQW2UAS33NF00□ | 33nH ±1% | 50MHz | 60 | 350MHz | 1000mA | 0.14Ω | 1600MHz |
| LQW2UAS33NG00□ | 33nH ±2% | 50MHz | 60 | 350MHz | 1000mA | 0.14Ω | 1600MHz |
| LQW2UAS33NJ00□ | 33nH ±5% | 50MHz | 60 | 350MHz | 1000mA | 0.14Ω | 1600MHz |
| LQW2UAS39NF00□ | 39nH ±1% | 50MHz | 60 | 350MHz | 1000mA | 0.15Ω | 1500MHz |
| LQW2UAS39NG00□ | 39nH ±2% | 50MHz | 60 | 350MHz | 1000mA | 0.15Ω | 1500MHz |
| LQW2UAS39NJ00□ | 39nH ±5% | 50MHz | 60 | 350MHz | 1000mA | 0.15Ω | 1500MHz |
| LQW2UAS47NF00□ | 47nH ±1% | 50MHz | 65 | 350MHz | 1000mA | 0.16Ω | 1500MHz |
| LQW2UAS47NG00□ | 47nH ±2% | 50MHz | 65 | 350MHz | 1000mA | 0.16Ω | 1500MHz |
| LQW2UAS47NJ00□ | 47nH ±5% | 50MHz | 65 | 350MHz | 1000mA | 0.16Ω | 1500MHz |
| LQW2UAS56NF00□ | 56nH ±1% | 50MHz | 65 | 350MHz | 1000mA | 0.18Ω | 1300MHz |
| LQW2UAS56NG00□ | 56nH ±2% | 50MHz | 65 | 350MHz | 1000mA | 0.18Ω | 1300MHz |
| LQW2UAS56NJ00□ | 56nH ±5% | 50MHz | 65 | 350MHz | 1000mA | 0.18Ω | 1300MHz |
| LQW2UAS68NF00□ | 68nH ±1% | 50MHz | 65 | 350MHz | 1000mA | 0.2Ω | 1300MHz |
| LQW2UAS68NG00□ | 68nH ±2% | 50MHz | 65 | 350MHz | 1000mA | 0.2Ω | 1300MHz |
| LQW2UAS68NJ00□ | 68nH ±5% | 50MHz | 65 | 350MHz | 1000mA | 0.2Ω | 1300MHz |
| LQW2UAS82NF00□ | 82nH ±1% | 50MHz | 60 | 350MHz | 1000mA | 0.22Ω | 1000MHz |
| LQW2UAS82NG00□ | 82nH ±2% | 50MHz | 60 | 350MHz | 1000mA | 0.22Ω | 1000MHz |
| LQW2UAS82NJ00□ | 82nH ±5% | 50MHz | 60 | 350MHz | 1000mA | 0.22Ω | 1000MHz |
| LQW2UASR10F00□ | 100nH ±1% | 25MHz | 60 | 350MHz | 650mA | 0.56Ω | 1000MHz |
| LQW2UASR10G00□ | 100nH ±2% | 25MHz | 60 | 350MHz | 650mA | 0.56Ω | 1000MHz |
| LQW2UASR10J00□ | 100nH ±5% | 25MHz | 60 | 350MHz | 650mA | 0.56Ω | 1000MHz |
| LQW2UASR12F00□ | 120nH ±1% | 25MHz | 60 | 350MHz | 650mA | 0.63Ω | 950MHz |
| LQW2UASR12G00□ | 120nH ±2% | 25MHz | 60 | 350MHz | 650mA | 0.63Ω | 950MHz |
| LQW2UASR12J00□ | 120nH ±5% | 25MHz | 60 | 350MHz | 650mA | 0.63Ω | 950MHz |
| LQW2UASR15F00□ | 150nH ±1% | 25MHz | 45 | 100MHz | 580mA | 0.7Ω | 850MHz |
| LQW2UASR15G00□ | 150nH ±2% | 25MHz | 45 | 100MHz | 580mA | 0.7Ω | 850MHz |
| LQW2UASR15J00□ | 150nH ±5% | 25MHz | 45 | 100MHz | 580mA | 0.7Ω | 850MHz |
| LQW2UASR18F00□ | 180nH ±1% | 25MHz | 45 | 100MHz | 620mA | 0.77Ω | 750MHz |
| LQW2UASR18G00□ | 180nH ±2% | 25MHz | 45 | 100MHz | 620mA | 0.77Ω | 750MHz |
| LQW2UASR18J00□ | 180nH ±5% | 25MHz | 45 | 100MHz | 620mA | 0.77Ω | 750MHz |
| LQW2UASR22F00□ | 220nH ±1% | 25MHz | 45 | 100MHz | 500mA | 0.84Ω | 700MHz |
| LQW2UASR22G00□ | 220nH ±2% | 25MHz | 45 | 100MHz | 500mA | 0.84Ω | 700MHz |
| LQW2UASR22J00□ | 220nH ±5% | 25MHz | 45 | 100MHz | 500mA | 0.84Ω | 700MHz |
| LQW2UASR27F00□ | 270nH ±1% | 25MHz | 45 | 100MHz | 500mA | 0.91Ω | 600MHz |
| LQW2UASR27G00□ | 270nH ±2% | 25MHz | 45 | 100MHz | 500mA | 0.91Ω | 600MHz |
| LQW2UASR27J00□ | 270nH ±5% | 25MHz | 45 | 100MHz | 500mA | 0.91Ω | 600MHz |
| LQW2UASR33F00□ | 330nH ±1% | 25MHz | 45 | 100MHz | 450mA | 1.05Ω | 570MHz |
| LQW2UASR33G00□ | 330nH ±2% | 25MHz | 45 | 100MHz | 450mA | 1.05Ω | 570MHz |
| LQW2UASR33J00□ | 330nH ±5% | 25MHz | 45 | 100MHz | 450mA | 1.05Ω | 570MHz |
| LQW2UASR39F00□ | 390nH ±1% | 25MHz | 45 | 100MHz | 470mA | 1.12Ω | 500MHz |
| LQW2UASR39G00□ | 390nH ±2% | 25MHz | 45 | 100MHz | 470mA | 1.12Ω | 500MHz |
| LQW2UASR39J00□ | 390nH ±5% | 25MHz | 45 | 100MHz | 470mA | 1.12Ω | 500MHz |
| LQW2UASR47F00□ | 470nH ±1% | 25MHz | 45 | 100MHz | 470mA | 1.19Ω | 450MHz |
| LQW2UASR47G00□ | 470nH ±2% | 25MHz | 45 | 100MHz | 470mA | 1.19Ω | 450MHz |

Operating temp. range: -55 to 125°C
 Only for reflow soldering
 *S.R.F.: Self Resonant Frequency

Continued on the following page. ↗

Continued from the preceding page. ↘

| Part Number (□: packaging code) | Inductance | Inductance Test Frequency | Q (min.) | Q Test Frequency | Rated Current | Max. of DC Resistance | S.R.F.* (min.) |
|------------------------------------|------------|------------------------------|----------|------------------|---------------|-----------------------|----------------|
| LQW2UASR47J00□ | 470nH ±5% | 25MHz | 45 | 100MHz | 470mA | 1.19Ω | 450MHz |
| LQW2UASR56F00□ | 560nH ±1% | 25MHz | 45 | 100MHz | 400mA | 1.33Ω | 415MHz |
| LQW2UASR56G00□ | 560nH ±2% | 25MHz | 45 | 100MHz | 400mA | 1.33Ω | 415MHz |
| LQW2UASR56J00□ | 560nH ±5% | 25MHz | 45 | 100MHz | 400mA | 1.33Ω | 415MHz |
| LQW2UASR62F00□ | 620nH ±1% | 25MHz | 45 | 100MHz | 300mA | 1.4Ω | 375MHz |
| LQW2UASR62G00□ | 620nH ±2% | 25MHz | 45 | 100MHz | 300mA | 1.4Ω | 375MHz |
| LQW2UASR62J00□ | 620nH ±5% | 25MHz | 45 | 100MHz | 300mA | 1.4Ω | 375MHz |
| LQW2UASR68F00□ | 680nH ±1% | 25MHz | 45 | 100MHz | 400mA | 1.47Ω | 375MHz |
| LQW2UASR68G00□ | 680nH ±2% | 25MHz | 45 | 100MHz | 400mA | 1.47Ω | 375MHz |
| LQW2UASR68J00□ | 680nH ±5% | 25MHz | 45 | 100MHz | 400mA | 1.47Ω | 375MHz |
| LQW2UASR75F00□ | 750nH ±1% | 25MHz | 45 | 100MHz | 360mA | 1.54Ω | 360MHz |
| LQW2UASR75G00□ | 750nH ±2% | 25MHz | 45 | 100MHz | 360mA | 1.54Ω | 360MHz |
| LQW2UASR75J00□ | 750nH ±5% | 25MHz | 45 | 100MHz | 360mA | 1.54Ω | 360MHz |
| LQW2UASR82F00□ | 820nH ±1% | 25MHz | 45 | 100MHz | 400mA | 1.61Ω | 350MHz |
| LQW2UASR82G00□ | 820nH ±2% | 25MHz | 45 | 100MHz | 400mA | 1.61Ω | 350MHz |
| LQW2UASR82J00□ | 820nH ±5% | 25MHz | 45 | 100MHz | 400mA | 1.61Ω | 350MHz |
| LQW2UASR91F00□ | 910nH ±1% | 25MHz | 35 | 50MHz | 380mA | 1.68Ω | 320MHz |
| LQW2UASR91G00□ | 910nH ±2% | 25MHz | 35 | 50MHz | 380mA | 1.68Ω | 320MHz |
| LQW2UASR91J00□ | 910nH ±5% | 25MHz | 35 | 50MHz | 380mA | 1.68Ω | 320MHz |
| LQW2UAS1R0F00□ | 1000nH ±1% | 25MHz | 35 | 50MHz | 370mA | 1.75Ω | 290MHz |
| LQW2UAS1R0G00□ | 1000nH ±2% | 25MHz | 35 | 50MHz | 370mA | 1.75Ω | 290MHz |
| LQW2UAS1R0J00□ | 1000nH ±5% | 25MHz | 35 | 50MHz | 370mA | 1.75Ω | 290MHz |
| LQW2UAS1R2J00□ | 1200nH ±5% | 7.9MHz | 35 | 50MHz | 310mA | 2.0Ω | 210MHz |
| LQW2UAS1R5J00□ | 1500nH ±5% | 7.9MHz | 28 | 50MHz | 330mA | 2.3Ω | 120MHz |
| LQW2UAS1R8J00□ | 1800nH ±5% | 7.9MHz | 28 | 50MHz | 300mA | 2.6Ω | 140MHz |
| LQW2UAS2R2J00□ | 2200nH ±5% | 7.9MHz | 28 | 50MHz | 280mA | 2.8Ω | 130MHz |
| LQW2UAS2R7J00□ | 2700nH ±5% | 7.9MHz | 22 | 25MHz | 290mA | 3.2Ω | 110MHz |
| LQW2UAS3R3J00□ | 3300nH ±5% | 7.9MHz | 22 | 25MHz | 290mA | 3.4Ω | 90MHz |
| LQW2UAS3R9J00□ | 3900nH ±5% | 7.9MHz | 20 | 25MHz | 260mA | 3.6Ω | 70MHz |
| LQW2UAS4R7J00□ | 4700nH ±5% | 7.9MHz | 20 | 25MHz | 260mA | 4.0Ω | 60MHz |

Operating temp. range: -55 to 125°C

Only for reflow soldering

*S.R.F.: Self Resonant Frequency

Inductance-Frequency Characteristics (Typ.)



Q-Frequency Characteristics (Typ.)



Inductors for Power Lines
 Inductors for General Circuits
 RF Inductors
 LQW2UAS_00

LQW31HN_03 Series 1206 (3216) inch (mm)



| Packaging Code | Packaging | Minimum Quantity |
|----------------|------------------------|------------------|
| K | ø330mm Embossed Taping | 7500 |
| L | ø180mm Embossed Taping | 2000 |

| Part Number (□: packaging code) | Inductance | Inductance Test Frequency | Q (min.) | Q Test Frequency | Rated Current | DC Resistance | S.R.F.* (min.) |
|------------------------------------|-------------|---------------------------|----------|------------------|---------------|---------------|----------------|
| LQW31HN8N8J03□ | 8.8nH ±5% | 100MHz | 50 | 436MHz | 750mA | 0.029Ω±40% | 1000MHz |
| LQW31HN8N8K03□ | 8.8nH ±10% | 100MHz | 50 | 436MHz | 750mA | 0.029Ω±40% | 1000MHz |
| LQW31HN15NJ03□ | 14.7nH ±5% | 100MHz | 60 | 436MHz | 680mA | 0.035Ω±40% | 1000MHz |
| LQW31HN15NK03□ | 14.7nH ±10% | 100MHz | 60 | 436MHz | 680mA | 0.035Ω±40% | 1000MHz |
| LQW31HN17NJ03□ | 17nH ±5% | 100MHz | 60 | 436MHz | 650mA | 0.037Ω±40% | 1000MHz |
| LQW31HN17NK03□ | 17nH ±10% | 100MHz | 60 | 436MHz | 650mA | 0.037Ω±40% | 1000MHz |
| LQW31HN23NJ03□ | 23nH ±5% | 100MHz | 60 | 436MHz | 590mA | 0.046Ω±40% | 1000MHz |
| LQW31HN23NK03□ | 23nH ±10% | 100MHz | 60 | 436MHz | 590mA | 0.046Ω±40% | 1000MHz |
| LQW31HN27NJ03□ | 27nH ±5% | 100MHz | 60 | 436MHz | 560mA | 0.051Ω±40% | 1000MHz |
| LQW31HN27NK03□ | 27nH ±10% | 100MHz | 60 | 436MHz | 560mA | 0.051Ω±40% | 1000MHz |
| LQW31HN33NJ03□ | 33nH ±5% | 100MHz | 60 | 436MHz | 530mA | 0.057Ω±40% | 1000MHz |
| LQW31HN33NK03□ | 33nH ±10% | 100MHz | 60 | 436MHz | 530mA | 0.057Ω±40% | 1000MHz |
| LQW31HN39NJ03□ | 39nH ±5% | 100MHz | 60 | 436MHz | 490mA | 0.067Ω±40% | 1000MHz |
| LQW31HN39NK03□ | 39nH ±10% | 100MHz | 60 | 436MHz | 490mA | 0.067Ω±40% | 1000MHz |
| LQW31HN47NJ03□ | 47nH ±5% | 100MHz | 60 | 436MHz | 380mA | 0.11Ω±40% | 1000MHz |
| LQW31HN47NK03□ | 47nH ±10% | 100MHz | 60 | 436MHz | 380mA | 0.11Ω±40% | 1000MHz |
| LQW31HN56NJ03□ | 56nH ±5% | 100MHz | 60 | 436MHz | 330mA | 0.14Ω±40% | 1000MHz |
| LQW31HN56NK03□ | 56nH ±10% | 100MHz | 60 | 436MHz | 330mA | 0.14Ω±40% | 1000MHz |
| LQW31HN64NJ03□ | 64nH ±5% | 100MHz | 60 | 436MHz | 290mA | 0.18Ω±40% | 1000MHz |
| LQW31HN64NK03□ | 64nH ±10% | 100MHz | 60 | 436MHz | 290mA | 0.18Ω±40% | 1000MHz |
| LQW31HN84NJ03□ | 84nH ±5% | 100MHz | 60 | 436MHz | 240mA | 0.28Ω±40% | 1000MHz |
| LQW31HN84NK03□ | 84nH ±10% | 100MHz | 60 | 436MHz | 240mA | 0.28Ω±40% | 1000MHz |
| LQW31HNR10J03□ | 100nH ±5% | 100MHz | 60 | 436MHz | 230mA | 0.3Ω±40% | 900MHz |
| LQW31HNR10K03□ | 100nH ±10% | 100MHz | 60 | 436MHz | 230mA | 0.3Ω±40% | 900MHz |

Operating temp. range (Self-temp. rise not included): -40 to 85°C

*S.R.F.: Self Resonant Frequency

Inductance-Frequency Characteristics (Typ.)



Q-Frequency Characteristics (Typ.)



Inductors for Power Lines

Inductors for General Circuits

LQW31HN_03
RF Inductors

LQW15CN_00 Series 0402 (1005) inch (mm)



(in mm)

| Packaging Code | Packaging | Minimum Quantity |
|----------------|---------------------|------------------|
| D | ø180mm Paper Taping | 10000 |
| B | Packing in Bulk | 500 |

| Part Number (□: packaging code) | Inductance | Inductance Test Frequency | Rated Current | Max. of DC Resistance | S.R.F.* (min.) |
|------------------------------------|------------|---------------------------|---------------|-----------------------|----------------|
| LQW15CN18NJ00□ | 18nH ±5% | 100MHz | 1400mA | 0.046Ω | 3000MHz |
| LQW15CN33NJ00□ | 33nH ±5% | 100MHz | 1300mA | 0.065Ω | 1800MHz |
| LQW15CN48NJ00□ | 48nH ±5% | 100MHz | 1100mA | 0.078Ω | 1400MHz |
| LQW15CN70NJ00□ | 70nH ±5% | 100MHz | 820mA | 0.12Ω | 1300MHz |
| LQW15CN96NJ00□ | 96nH ±5% | 100MHz | 730mA | 0.16Ω | 1100MHz |
| LQW15CNR13J00□ | 130nH ±5% | 100MHz | 640mA | 0.23Ω | 1000MHz |
| LQW15CNR16J00□ | 160nH ±5% | 100MHz | 480mA | 0.33Ω | 900MHz |
| LQW15CNR20J00□ | 200nH ±5% | 100MHz | 390mA | 0.47Ω | 800MHz |

Operating temp. range (Self-temp. rise not included): -55 to 125°C

Class of Magnetic Shield: No Shield

Only for reflow soldering

*S.R.F.: Self Resonant Frequency

In operating temperatures exceeding +85°C, derating of current is necessary for the LQW15C series. Please apply the derating curve shown in the chart according to the operating temperature. Please consider "Notice (Rating)."

Inductance-Frequency Characteristics (Typ.)



— LQW15CN18NJ00 18nH - - - LQW15CN70NJ00 70nH
 — LQW15CNR13J00 130nH - - - LQW15CNR20J00 200nH

Impedance-Frequency Characteristics (Typ.)



— LQW15CN18NJ00 18nH - - - LQW15CN70NJ00 70nH
 — LQW15CNR13J00 130nH - - - LQW15CNR20J00 200nH

Notice (Rating)

In operating temperatures exceeding +85°C, derating of current is necessary for this series. Please apply the derating curve shown in the chart according to the operating temperature.

Derating of Rated Current



LQW15CN_10 Series 0402 (1005) inch (mm)



(in mm)

| Packaging Code | Packaging | Minimum Quantity |
|----------------|---------------------|------------------|
| D | ø180mm Paper Taping | 10000 |
| B | Packing in Bulk | 500 |

Continued on the following page. ↗

Continued from the preceding page. ↘

| Part Number (□: packaging code) | Inductance | Inductance Test Frequency | Rated Current | Max. of DC Resistance | S.R.F.* (min.) |
|------------------------------------|-------------|------------------------------|---------------|-----------------------|----------------|
| LQW15CN20NJ10□ | 20nH ±5% | 100MHz | 2200mA | 0.028Ω | 3000MHz |
| LQW15CN20NK10□ | 20nH ±10% | 100MHz | 2200mA | 0.028Ω | 3000MHz |
| LQW15CN34NJ10□ | 34nH ±5% | 100MHz | 1800mA | 0.036Ω | 2500MHz |
| LQW15CN34NK10□ | 34nH ±10% | 100MHz | 1800mA | 0.036Ω | 2500MHz |
| LQW15CN53NJ10□ | 53nH ±5% | 100MHz | 1300mA | 0.06Ω | 2000MHz |
| LQW15CN53NK10□ | 53nH ±10% | 100MHz | 1300mA | 0.06Ω | 2000MHz |
| LQW15CN77NJ10□ | 77nH ±5% | 100MHz | 1100mA | 0.09Ω | 2000MHz |
| LQW15CN77NK10□ | 77nH ±10% | 100MHz | 1100mA | 0.09Ω | 2000MHz |
| LQW15CNR11J10□ | 106nH ±5% | 100MHz | 850mA | 0.144Ω | 1500MHz |
| LQW15CNR11K10□ | 106nH ±10% | 100MHz | 850mA | 0.144Ω | 1500MHz |
| LQW15CNR14J10□ | 140nH ±5% | 100MHz | 650mA | 0.216Ω | 1000MHz |
| LQW15CNR14K10□ | 140nH ±10% | 100MHz | 650mA | 0.216Ω | 1000MHz |
| LQW15CNR18J10□ | 180nH ±5% | 100MHz | 560mA | 0.312Ω | 1000MHz |
| LQW15CNR18K10□ | 180nH ±10% | 100MHz | 560mA | 0.312Ω | 1000MHz |
| LQW15CNR22J10□ | 220nH ±5% | 100MHz | 450mA | 0.47Ω | 1400MHz |
| LQW15CNR22K10□ | 220nH ±10% | 100MHz | 450mA | 0.47Ω | 1400MHz |
| LQW15CNR27J10□ | 270nH ±5% | 100MHz | 420mA | 0.52Ω | 830MHz |
| LQW15CNR27K10□ | 270nH ±10% | 100MHz | 420mA | 0.52Ω | 830MHz |
| LQW15CNR33J10□ | 330nH ±5% | 100MHz | 390mA | 0.56Ω | 520MHz |
| LQW15CNR33K10□ | 330nH ±10% | 100MHz | 390mA | 0.56Ω | 520MHz |
| LQW15CNR39J10□ | 390nH ±5% | 100MHz | 370mA | 0.62Ω | 450MHz |
| LQW15CNR39K10□ | 390nH ±10% | 100MHz | 370mA | 0.62Ω | 450MHz |
| LQW15CNR42J10□ | 420nH ±5% | 10MHz | 370mA | 0.62Ω | 400MHz |
| LQW15CNR42K10□ | 420nH ±10% | 10MHz | 370mA | 0.62Ω | 400MHz |
| LQW15CNR47J10□ | 470nH ±5% | 10MHz | 350mA | 0.66Ω | 380MHz |
| LQW15CNR47K10□ | 470nH ±10% | 10MHz | 350mA | 0.66Ω | 380MHz |
| LQW15CNR56J10□ | 560nH ±5% | 10MHz | 300mA | 0.71Ω | 300MHz |
| LQW15CNR56K10□ | 560nH ±10% | 10MHz | 300mA | 0.71Ω | 300MHz |
| LQW15CNR68M10□ | 680nH ±20% | 1MHz | 290mA | 0.78Ω | 290MHz |
| LQW15CNR82M10□ | 820nH ±20% | 1MHz | 275mA | 0.84Ω | 200MHz |
| LQW15CN1R0M10□ | 1000nH ±20% | 1MHz | 270mA | 0.94Ω | 120MHz |
| LQW15CN1R5M10□ | 1500nH ±20% | 1MHz | 190mA | 1.50Ω | 120MHz |
| LQW15CN2R2M10□ | 2200nH ±20% | 1MHz | 170mA | 1.80Ω | 100MHz |
| LQW15CN3R3M10□ | 3300nH ±20% | 1MHz | 130mA | 3.65Ω | 80MHz |

Operating temp. range (Self-temp. rise not included): -55 to 125°C

Class of Magnetic Shield: No Shield

Only for reflow soldering

*S.R.F.: Self Resonant Frequency

In operating temperatures exceeding +85°C, derating of current is necessary for the LQW15C series. Please apply the derating curve shown in the chart according to the operating temperature. Please consider "Notice (Rating)."

Inductance-Frequency Characteristics (Typ.)



Impedance-Frequency Characteristics (Typ.)



Notice (Rating)

In operating temperatures exceeding +85°C, derating of current is necessary for this series.

Please apply the derating curve shown in the chart according to the operating temperature.

Derating of Rated Current



LQW18CN_00 Series 0603 (1608) inch (mm)



| Packaging Code | Packaging | Minimum Quantity |
|----------------|---------------------|------------------|
| D | ø180mm Paper Taping | 4000 |
| J | ø330mm Paper Taping | 10000 |
| B | Packing in Bulk | 500 |

| Part Number (□: packaging code) | Inductance | Inductance Test Frequency | Rated Current | Max. of DC Resistance | S.R.F.* (min.) |
|------------------------------------|--------------|---------------------------|---------------|-----------------------|----------------|
| LQW18CN4N9D00□ | 4.9nH ±0.5nH | 10MHz | 2600mA | 0.015Ω | 2300MHz |
| LQW18CN15NJ00□ | 15nH ±5% | 10MHz | 2200mA | 0.025Ω | 2000MHz |
| LQW18CN33NJ00□ | 33nH ±5% | 10MHz | 1700mA | 0.035Ω | 1800MHz |
| LQW18CN55NJ00□ | 55nH ±5% | 10MHz | 1500mA | 0.045Ω | 1600MHz |
| LQW18CN85NJ00□ | 85nH ±5% | 10MHz | 1400mA | 0.060Ω | 1380MHz |
| LQW18CNR10K00□ | 100nH ±10% | 10MHz | 1000mA | 0.10Ω | 1260MHz |
| LQW18CNR12J00□ | 120nH ±5% | 10MHz | 1100mA | 0.085Ω | 1200MHz |
| LQW18CNR16J00□ | 160nH ±5% | 10MHz | 1000mA | 0.10Ω | 900MHz |
| LQW18CNR21J00□ | 210nH ±5% | 10MHz | 800mA | 0.15Ω | 720MHz |
| LQW18CNR27J00□ | 270nH ±5% | 10MHz | 750mA | 0.16Ω | 660MHz |
| LQW18CNR33J00□ | 330nH ±5% | 10MHz | 630mA | 0.25Ω | 600MHz |
| LQW18CNR39J00□ | 390nH ±5% | 10MHz | 620mA | 0.28Ω | 570MHz |
| LQW18CNR47J00□ | 470nH ±5% | 10MHz | 500mA | 0.45Ω | 555MHz |
| LQW18CNR56J00□ | 560nH ±5% | 10MHz | 450mA | 0.48Ω | 540MHz |
| LQW18CNR65J00□ | 650nH ±5% | 10MHz | 430mA | 0.52Ω | 510MHz |

Operating temp. range: -40 to 85°C
 Class of Magnetic Shield: No Shield
 Only for reflow soldering
 *S.R.F.: Self Resonant Frequency

Inductance-Frequency Characteristics (Typ.)



Impedance-Frequency Characteristics (Typ.)



LQW21HN_00 Series 0805 (2012) inch (mm)



| Packaging Code | Packaging | Minimum Quantity |
|----------------|------------------------|------------------|
| L | ø180mm Embossed Taping | 3000 |
| B | Packing in Bulk | 500 |

| Part Number (□: packaging code) | Inductance | Inductance Test Frequency | Q (min.) | Q Test Frequency | Rated Current | Max. of DC Resistance | S.R.F.* (min.) |
|------------------------------------|------------|---------------------------|----------|------------------|---------------|-----------------------|----------------|
| LQW21HNR47J00□ | 0.47μH ±5% | 10MHz | 35 | 100MHz | 160mA | 1.30Ω | 620MHz |
| LQW21HNR56J00□ | 0.56μH ±5% | 10MHz | 35 | 100MHz | 150mA | 1.43Ω | 580MHz |
| LQW21HNR68J00□ | 0.68μH ±5% | 10MHz | 35 | 100MHz | 130mA | 2.21Ω | 520MHz |
| LQW21HNR82J00□ | 0.82μH ±5% | 10MHz | 35 | 100MHz | 125mA | 2.34Ω | 480MHz |
| LQW21HN1R0J00□ | 1.0μH ±5% | 10MHz | 35 | 100MHz | 115mA | 2.86Ω | 450MHz |
| LQW21HN1R2J00□ | 1.2μH ±5% | 10MHz | 35 | 100MHz | 100mA | 3.12Ω | 400MHz |
| LQW21HN1R5J00□ | 1.5μH ±5% | 10MHz | 35 | 100MHz | 85mA | 5.33Ω | 350MHz |
| LQW21HN1R8J00□ | 1.8μH ±5% | 10MHz | 35 | 100MHz | 80mA | 5.85Ω | 320MHz |
| LQW21HN2R2J00□ | 2.2μH ±5% | 10MHz | 35 | 100MHz | 75mA | 6.50Ω | 300MHz |

Operating temp. range: -40 to 85°C

Only for reflow soldering

*S.R.F.: Self Resonant Frequency

Inductance-Frequency Characteristics (Typ.)



Q-Frequency Characteristics (Typ.)



LQH31HN_03 Series 1206 (3216) inch (mm)



| Packaging Code | Packaging | Minimum Quantity |
|----------------|------------------------|------------------|
| K | ø330mm Embossed Taping | 7500 |
| L | ø180mm Embossed Taping | 2000 |

Continued on the following page. ↗

Continued from the preceding page. ↘

| Part Number (□: packaging code) | Inductance | Inductance Test Frequency | Q (min.) | Q Test Frequency | Rated Current | DC Resistance | S.R.F.* (min.) |
|------------------------------------|------------|------------------------------|----------|------------------|---------------|---------------|----------------|
| LQH31HNS4NK03□ | 54nH ±10% | 1MHz | 50 | 100MHz | 920mA | 0.035Ω±30% | 800MHz |
| LQH31HN95NK03□ | 95nH ±10% | 1MHz | 60 | 100MHz | 790mA | 0.047Ω±30% | 650MHz |
| LQH31HNR14J03□ | 145nH ±5% | 1MHz | 60 | 100MHz | 700mA | 0.061Ω±30% | 500MHz |
| LQH31HNR14K03□ | 145nH ±10% | 1MHz | 60 | 100MHz | 700mA | 0.061Ω±30% | 500MHz |
| LQH31HNR21J03□ | 215nH ±5% | 1MHz | 60 | 100MHz | 520mA | 0.11Ω±30% | 430MHz |
| LQH31HNR21K03□ | 215nH ±10% | 1MHz | 60 | 100MHz | 520mA | 0.11Ω±30% | 430MHz |
| LQH31HNR29J03□ | 290nH ±5% | 1MHz | 60 | 100MHz | 420mA | 0.17Ω±30% | 360MHz |
| LQH31HNR29K03□ | 290nH ±10% | 1MHz | 60 | 100MHz | 420mA | 0.17Ω±30% | 360MHz |
| LQH31HNR39J03□ | 390nH ±5% | 1MHz | 60 | 100MHz | 330mA | 0.26Ω±30% | 300MHz |
| LQH31HNR39K03□ | 390nH ±10% | 1MHz | 60 | 100MHz | 330mA | 0.26Ω±30% | 300MHz |
| LQH31HNR50J03□ | 500nH ±5% | 1MHz | 60 | 100MHz | 260mA | 0.44Ω±30% | 270MHz |
| LQH31HNR50K03□ | 500nH ±10% | 1MHz | 60 | 100MHz | 260mA | 0.44Ω±30% | 270MHz |
| LQH31HNR61J03□ | 610nH ±5% | 1MHz | 60 | 100MHz | 250mA | 0.48Ω±30% | 240MHz |
| LQH31HNR61K03□ | 610nH ±10% | 1MHz | 60 | 100MHz | 250mA | 0.48Ω±30% | 240MHz |
| LQH31HNR75J03□ | 750nH ±5% | 1MHz | 60 | 100MHz | 190mA | 0.79Ω±30% | 220MHz |
| LQH31HNR75K03□ | 750nH ±10% | 1MHz | 60 | 100MHz | 190mA | 0.79Ω±30% | 220MHz |
| LQH31HNR88J03□ | 880nH ±5% | 1MHz | 60 | 100MHz | 180mA | 0.86Ω±30% | 200MHz |
| LQH31HNR88K03□ | 880nH ±10% | 1MHz | 60 | 100MHz | 180mA | 0.86Ω±30% | 200MHz |

Operating temp. range: -40 to 85°C

*S.R.F.: Self Resonant Frequency

Inductance-Frequency Characteristics (Typ.)



Q-Frequency Characteristics (Typ.)



RF Inductors ⚠️Caution/Notice

⚠️Caution

Rating

1. About the Rated Current

Do not use products beyond the rated current as this may create excessive heat and deteriorate the insulation resistance.

Be sure to provide an appropriate fail-safe function on your product to prevent a second damage that may be caused by the abnormal function or the failure of our product.

2. About Excessive Surge Current

Surge current (pulse current or rush current) greater than the specified rated current applied to the product may cause a critical failure, such as an open circuit or burnout caused by excessive temperature rise.

Please contact us in advance if applying a surge current.

Notice

Storage and Operating Condition

<Operating Environment>

Do not use products in a chemical atmosphere such as chlorine gas, acid or sulfide gas.

<Storage Requirements>

1. Storage Period

The LQG series should be used within 6 months; the other products should be used within 12 months.

Check solderability if this period is exceeded.

2. Storage Conditions

(1) Store products in a warehouse in compliance with the following conditions:

Temperature: -10 to +40 degrees C.

Humidity: 15 to 85% (relative humidity)

Do not subject products to rapid changes in temperature and humidity.

Do not store them in a chemical atmosphere such as one containing sulfurous acid gas, or alkaline gas or acid.

This will prevent electrode oxidation, which causes poor solderability and possible corrosion of inductors.

(2) Do not store products in bulk packaging to prevent collision among inductors, which causes core chipping and wire breakage.

(3) Store products on pallets to protect from humidity, dust, etc.

(4) Avoid heat shock, vibration, direct sunlight, etc.

Handling

This item is designed to have sufficient strength, but handle with care to avoid chipping or breaking its ceramic structure.

LQW series

- Temperature may rise up to max. 40°C when applying the rated current to LQW_C/LQW15AN_80/LQW18AN_80/LQW2BA/LQW2UA. Use caution regarding the temperature rating of the circuit.
- To prevent breaking the wire, avoid touching with sharp materials, such as tweezers or the bristles of a cleaning brush, to the wire wound portion.
- To prevent breaking the core, avoid applying excessive mechanical shock to products mounted on the board.
- In some mounting machines, when picking up components, a support pin pushes the components up from the bottom of the base tape. In this case, please remove the support pin. The support pin may damage the components and break the wire.

LQH series

- To prevent breaking the wire, avoid touching with sharp materials, such as tweezers or the bristles of a cleaning brush, to the wire wound portion of this product.
- To prevent breaking the core, avoid applying excessive mechanical shock to products mounted on the board.

LQP15/18 series

- The pattern of the products is covered with protective film. Take care to avoid damaging the products when handling it with pick-up nozzles, sharp instruments, etc.

<Transportation>

Do not apply excessive vibration or mechanical shock to products.

Continued on the following page. ↗

RF Inductors ⚠Caution/Notice

Continued from the preceding page. ↘

<Resin Coating>

- except LQP02/03 series

When coating products with resin, the relatively high resin curing stress may change inductance values. For exterior coating, select resin carefully so that electrical and mechanical performance of the product is not affected. Prior to use, please evaluate reliability with the product mounted in your application set.

- LQH, LQW series

An open circuit issue may occur by mechanical stress caused by the resin, amount/cured shape of resin, or operating conditions, etc. Some resins containing impurities or chloride may possibly generate chlorine by hydrolysis under some operating conditions, causing corrosion of the inductor wire and leading to an open circuit.

- LQP02/03 series

When products are coated with resin, please contact us in advance.

<Handling of a Substrate>

After mounting products on a substrate, do not apply any stress to the product caused by bending or twisting the substrate when cropping the substrate, inserting and removing a connector from the substrate, or tightening a screw to the substrate.

Excessive mechanical stress may cause cracking in the Product.

Bending



Twisting



Measuring Method

Measuring Method of Inductance/Q

- Residual elements and stray elements of test fixtures can be described by F-parameter as shown in the following:



- The impedance of products Z_x and measured value Z_m can be described by input/output current/voltage.

$$Z_m = \frac{V_1}{I_1}, \quad Z_x = \frac{V_2}{I_2}$$

- Thus, the relation between Z_x and Z_m is shown in the following:

$$Z_x = \alpha \frac{Z_m - \beta}{1 - Z_m \Gamma}$$

where, $\alpha = D / A = 1$

$\beta = B / D = Z_{sm} - (1 - Y_{om} Z_{sm}) Z_{ss}$

$\Gamma = C / A = Y_{om}$

Z_{sm} : measured impedance of short chip
 Z_{ss} : residual impedance of short chip*
 Y_{om} : measured admittance when opening the fixture)

*Residual inductance of short chip

| Residual Inductance | Series |
|---------------------|---|
| 0nH | LQG15H, LQP03TG |
| 0.110nH | LQP02HQ, LQP02TN, LQP02TQ |
| 0.464nH | LQW04AN |
| 0.480nH | LQP03HQ, LQP03PN, LQP03TN, LQP03TQ, LQW03AW |
| 0.556nH | LQG15HN, LQW15A/C, LQP15M |
| 0.771nH | LQG18HN, LQP18M, LQW18AN, LQW18C, LQW21/31H, LQW2BAN, LQH31 |

- L_x and Q_x should be calculated with the following equation.

$$L_x = \frac{\text{Im}(Z_x)}{2\pi f}, \quad Q_x = \frac{\text{Im}(Z_x)}{\text{Re}(Z_x)}$$

L_x : Inductance of products
 Q_x : Q of products
 f : Measuring frequency

Please refer to specification documents for LQW18AS, LQW2BAS, LQW2UAS, because they are different from other inductors regarding the inductance calculation method.

RF Inductors Soldering and Mounting

1. Standard Land Pattern Dimensions

A high Q value is achieved when the PCB electrode land pattern is designed so that it does not project beyond the products' electrode.

Land Pattern + Solder Resist
 Land Pattern
 Solder Resist
 (in mm)

| Series | Standard Land Dimensions | | | |
|--|--|-------------|-------------|-------------|
| LQG15H LQG18H LQP02TN LQP02HQ/TQ LQP03HQ/P/T LQP15M LQP18M LQW03A LQW04A LQW15A/C LQW18A/C LQW21H LQW2BH LQW2BA LQW2UA LQW31H LQH31H |  | | | |
| | Part Number | a | b | c |
| | LQG15H | 0.4 | 1.4 to 1.5 | 0.5 to 0.6 |
| | LQG18H | 0.6 to 0.8 | 1.8 to 2.2 | 0.6 to 0.8 |
| | LQP02TN | 0.16 to 0.2 | 0.4 to 0.56 | 0.2 to 0.23 |
| | LQP02HQ/TQ | 0.2 | 0.56 | 0.16 |
| | LQP03HQ | 0.3 | 0.9 | 0.25 to 0.3 |
| | LQP03TN/TG/PN | 0.2 to 0.3 | 0.8 to 0.9 | 0.2 to 0.3 |
| | LQP03TQ | 0.3 | 0.9 | 0.24 |
| | LQP15M | 0.4 | 1.4 to 1.5 | 0.5 to 0.6 |
| | LQP18M | 0.7 to 0.9 | 1.8 to 2.2 | 0.6 to 0.8 |
| | LQW03A | 0.23 | 0.65 | 0.4 |
| | LQW04A | 0.4 | 1.0 | 0.4 |
| | LQW15A_00/10 | 0.5 | 1.2 | 0.65 |
| | LQW15AN_80 | 0.6 | 1.42 | 0.66 |
| | LQW15AW_80 | 0.51 | 1.23 | 0.66 |
| | LQW15CN_00 | 0.4 | 1.4 | 0.6 |
| | LQW15CN_10 | 0.4 | 1.4 | 0.66 |
| | LQW18AN_00/10/AS_00 | 0.6 to 0.8 | 1.9 to 2.0 | 0.7 to 1.0 |
| | LQW18AN_80 | 0.86 | 2.0 | 1.15 |
| | LQW18AS_0C | 0.65 | 2.0 | 1.0 |
| | LQW18C | 0.7 | 2.2 | 1.0 |
| | LQW21H | 1.0 | 2.6 | 1.2 |
| | LQW2BH | 0.8 | 3.0 | 1.2 |
| | LQW2BA | 0.76 | 2.8 | 1.78 |
| LQW2UA | 1.27 | 3.3 | 2.54 | |
| LQH31H | 1.0 | 4.5 | 1.5 | |
| LQW31H | | | | |

Attention should be paid to potential magnetic coupling effects when using the Inductor (coil) as a resonator.

2. Standard Soldering Conditions

(1) Soldering method

Apply reflow soldering process except for flow soldering available products.

Please contact Murata regarding other soldering methods.

Solder: Use Sn-3.0Ag-0.5Cu solder.

Flux: Use rosin-based flux, but not strongly acidic flux (with chlorine content exceeding 0.2wt%).

Do not use water-soluble flux.

The flux used for the LQW03/04/15/18/21/2BA/2UA series should be a rosin-based flux that includes a middle activator equivalent to 0.06wt% to 0.1wt% chlorine.

Please pay attention to solder paste's penetrating in order to avoid short circuit between the lines.
 For additional mounting methods, please contact Murata.

Continued on the following page. ↗

RF Inductors Soldering and Mounting

Continued from the preceding page. ↘

(2) Soldering profile

● Flow Soldering profile



| Series | Pre-heating | | Standard Profile | | | Limit Profile | | |
|----------------------|-------------|------------|------------------|------------|---------------|---------------|------------|---------------|
| | Temp. (T1) | Time. (t1) | Heating | | Cycle of flow | Heating | | Cycle of flow |
| | | | Temp. (T2) | Time. (t2) | | Temp. (T3) | Time. (t2) | |
| LQW2BH/31H LQH31H | 150°C | 60s min. | 250°C | 4 to 6s | 2 times max. | 265±3°C | 5s max. | 2 times max. |

● Reflow Soldering profile



| Series | Standard Profile | | | | Limit Profile | | | |
|--|------------------|------------|-----------------------|-----------------|---------------|------------|-----------------------|-----------------|
| | Heating | | Peak temperature (T2) | Cycle of reflow | Heating | | Peak temperature (T4) | Cycle of reflow |
| | Temp. (T1) | Time. (t1) | | | Temp. (T3) | Time. (t2) | | |
| LQG15H/18H LQW03A/04A/15/18/21H LQW2BA/2UA LQP02/03/15M/18M LQW2BH/31H LQH31H | 220°C | 30 to 60s | 245±3°C | 2 times max. | 230°C | 60s max. | 260°C/10s | 2 times max. |

(3) Reworking with a Soldering Iron

*Except for LQP02/LQW04/03/15AN_80/15AW_80 Series

Preheating at 150°C for 1 minute is required. Do not directly touch the ceramic element with the tip of the soldering iron. The reworking soldering conditions are as follows:

Soldering iron power output: 80W max.

Temperature of soldering iron tip: 350°C

Diameter of soldering iron end: 3.0mm max.

Soldering time: within 3 s

Please keep the fix time with the soldering iron within 1 time for each terminal.

Continued on the following page. ↗

RF Inductors Soldering and Mounting

Continued from the preceding page. ↘

3. Mounting Instructions

(1) Land Pattern Dimensions

Large land design tend to reduce Q value of the product. Also, large protruding land areas (bordered by lines having the dimensions "c" and "d" shown) cause floating and electrode leaching.



(2) Land Pattern Designing (LQW series)

Please follow the recommended patterns. Otherwise, their performance, which includes electrical performance or solderability, may be affected, or result in "position shift" in the soldering process.

(3) PCB Warping

The PCB should be designed so that products are not subjected to mechanical stress caused by warping the board.



Continued on the following page. ↗

RF Inductors Soldering and Mounting

Continued from the preceding page. ↘

(4) Amount of Solder Paste

Excessive solder causes electrode corrosion, while insufficient solder causes low electrode bonding strength. Adjust the amount of solder paste as shown on the right so that the correct amount is applied.

Guideline of solder paste thickness

- LQP (*Except for LQP02TN/LQP02TQ/HQ/LQP03TQ/HQ), LQG, LQW15AN_00/LQW15AN_10/LQW18AN/LQW18AS/LQW21H/LQW2BA/LQW2UA: 100 to 150μm
- LQP02TN: 50 to 80μm
- LQP02TQ/HQ: 50 to 65μm
- LQP03TQ/HQ: 100μm
- LQW03A/LQW04A: 80 to 100μm
- LQW15AN_80/15AW_80/15C/18C: 50 to 100μm
- LQW_H/LQH31H: 200 to 300μm



4. Cleaning

The following conditions should be observed when cleaning products:

- (1) Cleaning Temperature: 60°C max. (40°C max. for alcohol cleaning agents)
- (2) Ultrasonic
 - Output: 20W/l max.
 - Duration: 5 minutes max.
 - Frequency: 28 to 40kHz
 - Care should be taken not to cause resonance of the PCB and mounted products.

(3) Cleaning agent

The following cleaning agents have been tested on individual components. Evaluation in complete assembly should be done prior to production.

- (a) Alcohol cleaning agents
 - Isopropyl alcohol (IPA)
- (b) Aqueous cleaning agents
 - Pine Alpha ST-100S

- (4) Ensure that flux residue is completely removed. Component should be thoroughly dried after aqueous agents have been removed with deionized water.

For additional cleaning methods, please contact Murata.

RF Inductors Packaging

Minimum Quantity and 8mm Width Taping Dimensions



Paper Tape

| Part Number | Dimensions | | Total Thickness of Tape c | Packaging Code (Minimum Qty. (pcs.)) | | |
|------------------|---------------------|-----------|------------------------------|--------------------------------------|-------------|----------|
| | a | b | | ø180mm reel | ø330mm reel | Bulk |
| LQG15H | 0.62 | 1.12 | 0.8 max. | D (10000) | J (50000) | B (1000) |
| LQP02TN | 0.24 | 0.47 | 0.39 max. | D (20000) | — | B (500) |
| LQP02TQ | 0.23 | 0.45 | 0.39 max. | D (20000) | — | B (500) |
| LQP03HQ | 0.36 | 0.68 | 0.55 max. | D (15000) | J (50000) | B (500) |
| LQP03TN/TG/TQ *1 | 0.35 | 0.65/0.67 | 0.55 max. | D (15000) | J (50000) | B (500) |
| LQP15M | 0.70 | 1.20 | 0.8 max. | D (10000) | J (50000) | B (500) |
| LQP18M | 1.19 | 2.0 | 0.8 max. | D (4000) | J (10000) | B (500) |
| LQW03A | 0.52 | 0.65 | 0.75 max. | D (10000) | — | — |
| LQW04A | 0.49 | 0.91 | 0.75 max. | D (10000) | — | B (500) |
| LQW15A_00 *2 | 0.64/0.66/0.69 | 1.18 | 0.8 max. | D (10000) | — | B (500) |
| LQW15A_10 *3 | 0.66/0.69 | 1.18 | 0.8 max. | D (10000) | — | B (500) |
| LQW15AN_80 | 0.75 | 1.18 | 0.8 max. | D (10000) | — | B (500) |
| LQW15AW_80 | 0.76 | 1.20 | 0.8 max. | D (10000) | — | B (500) |
| LQW15CN_00 | 0.64: 70nH to 200nH | 1.18 | 0.8 max. | D (10000) | — | B (500) |
| | 0.66: 18nH to 48nH | | | | | |
| LQW15C_10 | 0.69 | 1.18 | 0.8 max. | D (10000) | — | B (500) |

*1 0.67 (LQP03TG · LQP03TN_02; 0.6 to 62nH, 130 to 270nH · LQP03PN, LQP03TQ)

0.65 (LQP03TN_02; 68 to 120nH)

*2 0.69 (1.5nH, 2.4 to 2.8nH, 3.9 to 4.8nH, 5.8 to 6.8nH, 8.2 to 9.9nH, 11nH, 12nH, 15nH)

0.66 (1.6 to 1.8nH, 2.9nH, 3.0nH, 3.1nH, 3.2nH, 4.9 to 5.1nH, 6.9 to 7.5nH, 10nH, 13nH, 16 to 23nH, 100nH, 120nH)

0.64 (24 to 91nH)

*3 0.69 (1.3nH, 1.4nH)

0.66 (2.2 to 8.4nH)

Embossed Tape

| Part Number | Dimensions | | Total Thickness of Tape c | Packaging Code (Minimum Qty. (pcs.)) | | |
|-------------|------------|------|------------------------------|--------------------------------------|-------------|---------|
| | a | b | | ø180mm reel | ø330mm reel | Bulk |
| LQP02HQ | 0.24 | 0.46 | 0.34 max. | E (15000) | — | B (500) |

(in mm)

Continued on the following page. ↗

RF Inductors Packaging

Continued from the preceding page. ↘

Minimum Quantity and 8mm Width Taping Dimensions



The dimension of the cavity of embossed tape is measured at the bottom side.

Paper Tape

| Part Number | Dimensions | | Total Thickness of Tape | Packaging Code (Minimum Qty. (pcs.)) | | |
|---------------|------------|------|-------------------------|--------------------------------------|-------------|-------------|
| | a | b | | c | ø180mm reel | ø330mm reel |
| LQG18H | 1.05 | 1.85 | 1.1 max. | D (4000) | J (10000) | B (1000) |
| LQW18AN_00 | 1.0 | 1.8 | 1.1 max. | D (4000) | J (10000) | B (500) |
| LQW18AN_10 | 1.1 | 1.9 | 1.1 max. | D (4000) | J (10000) | B (500) |
| LQW18AN_80 | 1.15 | 1.9 | 1.1 max. | D (4000) | J (10000) | B (500) |
| LQW18AS_00/0C | 1.06 | 1.86 | 1.1 max. | D (4000) | J (10000) | B (500) |
| LQW18C | 1.0 | 1.8 | 1.1 max. | D (4000) | J (10000) | B (500) |

Embossed Tape

| Part Number | Dimensions | | Depth of Cavity | Packaging Code (Minimum Qty. (pcs.)) | | |
|----------------|------------|-----|-----------------|--------------------------------------|-------------|-------------|
| | a | b | | c | ø180mm reel | ø330mm reel |
| LQH31H, LQW31H | 1.9 | 3.6 | 2.0 | L (2000) | K (7500) | — |
| LQW21H | 1.55 | 2.3 | 1.1 | L (3000) | — | B (500) |
| LQW2BH | 1.75 | 2.3 | 2.0 | L (2000) | K (7500) | — |
| LQW2BA | 1.8 | 2.3 | 1.65 | L (2000) | K (8000) | B (500) |
| LQW2UA | 2.7 | 2.8 | 2.15 | L (2000) | — | B (500) |

(in mm)

Minimum Quantity and 4mm Width Taping Dimensions



Embossed Tape

| Part Number | Dimensions | | Total Thickness of Tape | Packaging Code (Minimum Qty. (pcs.)) | | |
|-------------|------------|------|-------------------------|--------------------------------------|-------------|-------------|
| | a | b | | c | ø180mm reel | ø330mm reel |
| LQP02HQ | 0.24 | 0.46 | 0.34 max. | L (30000) | — | B (500) |
| LQP02TN | 0.21 | 0.43 | 0.23 max. | L (40000) | — | B (500) |
| LQP02TQ | 0.22 | 0.47 | 0.23 max. | L (40000) | — | B (500) |

(in mm)

Part Number Quick Reference

Series name (Part number): Indicated both series name and the initial letters of part number noted in brackets represents they are different.

Inductors for Power Lines

| | |
|-------------------------------|-----|
| D52LC (#A914BY*) | 88 |
| D53LC High Current (#A915AY*) | 89 |
| D53LC Low Rdc (#A915BY*) | 90 |
| D63LCB (#A921CY*) | 92 |
| DEM10050C (1274AS*) | 101 |
| DEM10050C_DD (DD1274AS*) | 102 |
| DEM2812C (1225AS*) | 69 |
| DEM2815C (1226AS*) | 69 |
| DEM2818C (1227AS*) | 70 |
| DEM3512C (1229AS*) | 76 |
| DEM3518C (1231AS*) | 76 |
| DEM4518C (1235AS*) | 84 |
| DEM8030C (1273AS*) | 98 |
| DEM8040C (1248AS*) | 98 |
| DEM8045C (1217AS*) | 99 |
| DFE18SAN_EO | 10 |
| DFE18SAN_GO | 10 |
| DFE18SBN_EO | 11 |
| DFE201208S | 12 |
| DFE201210S | 13 |
| DFE201210U | 13 |
| DFE201610C (1285AS*) | 14 |
| DFE201610E | 15 |
| DFE201610P | 16 |
| DFE201610R | 16 |
| DFE201612C (1286AS*) | 17 |
| DFE201612E | 18 |
| DFE201612P | 19 |
| DFE201612R | 19 |
| DFE252007F | 20 |
| DFE252008C | 21 |
| DFE252008U | 22 |
| DFE252010C (1269AS*) | 22 |
| DFE252010F | 23 |
| DFE252010P | 24 |
| DFE252010R | 25 |
| DFE252012C (1239AS*) | 26 |
| DFE252012F | 26 |
| DFE252012P | 27 |
| DFE252012R | 28 |
| DFE322510C (1276AS*) | 29 |
| DFE322512C (1277AS*) | 30 |
| DFE322512F | 30 |
| DG6028C (1253AY*) | 93 |
| DG6045C (1255AY*) | 93 |
| DG6050C (1264EY*) | 94 |
| DG8040C (1267AY*) | 100 |
| DS104C2 (#B952AS*) | 102 |
| DS106C2 (#B966AS*/BS*) | 103 |
| DS126C2 (#B953AS*) | 104 |
| DS75LC (B1047AS*) | 96 |
| FCUL0530 | 38 |
| FCUL0624 | 40 |
| FCUL0630 | 40 |
| FCUL1040 | 49 |
| FCUL1060 | 49 |
| FDA1055 | 46 |
| FDA1254 | 51 |
| FDSD0412 | 31 |
| FDSD0415 | 32 |
| FDSD0420 | 33 |
| FDSD0420W | 34 |
| FDSD0512 | 34 |
| FDSD0515 | 35 |
| FDSD0518 | 36 |
| FDSD0630 | 39 |
| FDUE0630 | 44 |
| FDUE0640 | 45 |

| | |
|-------------|-----|
| FDUE0650 | 46 |
| FDUE1040D | 47 |
| FDUE1245 | 50 |
| FDUE1260 | 52 |
| FDV0530 | 37 |
| FDV0530S | 37 |
| FDV0618 | 41 |
| FDV0620 | 42 |
| FDVE0630 | 43 |
| FDVE0640 | 44 |
| FDVE1040 | 48 |
| LQH2HPN_DR | 57 |
| LQH2HPN_GR | 58 |
| LQH2HPN_JR | 59 |
| LQH2MPCN_02 | 53 |
| LQH2MPCN_52 | 54 |
| LQH2MPN_GR | 55 |
| LQH31CN_03 | 60 |
| LQH32CN_23 | 60 |
| LQH32CN_33 | 61 |
| LQH32CN_53 | 62 |
| LQH32DN_23 | 63 |
| LQH32DN_53 | 64 |
| LQH32PB_NO | 65 |
| LQH32PB_NC | 66 |
| LQH32PN_NO | 67 |
| LQH32PN_NC | 68 |
| LQH3NPN_GR | 71 |
| LQH3NPN_JR | 72 |
| LQH3NPN_ME | 74 |
| LQH43CN_03 | 80 |
| LQH43CN_33 | 81 |
| LQH43PB_26 | 82 |
| LQH43PN_26 | 83 |
| LQH44PN_GR | 77 |
| LQH44PN_JO | 78 |
| LQH44PN_PO | 79 |
| LQH55DN_03 | 91 |
| LQH5BPB_TO | 85 |
| LQH5BPN_38 | 86 |
| LQH5BPN_TO | 87 |
| LQH66SN_03 | 95 |
| LQM18FN_00 | 106 |
| LQM18PN_00 | 106 |
| LQM18PN_CO | 107 |
| LQM18PN_DO | 108 |
| LQM18PN_DH | 108 |
| LQM18PN_FO | 109 |
| LQM18PN_FH | 110 |
| LQM18PN_FR | 110 |
| LQM18PN_GH | 111 |
| LQM18PNW_CH | 112 |
| LQM21DN_00 | 113 |
| LQM21FN_00 | 113 |
| LQM21FN_70 | 114 |
| LQM21FN_80 | 115 |
| LQM21PN_CO | 115 |
| LQM21PN_CA | 116 |
| LQM21PN_CH | 117 |
| LQM21PN_EH | 118 |
| LQM21PN_GH | 119 |
| LQM21PN_GC | 120 |
| LQM21PN_GH | 121 |
| LQM21PN_GR | 121 |
| LQM21PN_GS | 122 |
| LQM2HPN_CH | 126 |
| LQM2HPN_EO | 127 |
| LQM2HPN_EH | 128 |
| LQM2HPN_GO | 129 |
| LQM2HPN_GC | 130 |

| | |
|------------|-----|
| LQM2HPN_GH | 130 |
| LQM2HPN_GS | 131 |
| LQM2HPN_JO | 132 |
| LQM2HPN_JH | 133 |
| LQM2MPN_DH | 123 |
| LQM2MPN_EH | 124 |
| LQM2MPN_GO | 124 |
| LQM2MPN_GH | 126 |
| LQM31PN_00 | 133 |
| LQM32PN_GO | 134 |
| LQM32PN_GC | 135 |
| LQW15DN_00 | 52 |

Inductors for General Circuits

| | |
|------------|-----|
| LQB15NN_10 | 167 |
| LQB18NN_10 | 168 |
| LQH31MN_03 | 158 |
| LQH32MN_23 | 160 |
| LQH43MN_03 | 163 |
| LQH43NN_03 | 165 |
| LQH44NN_03 | 162 |
| LQM18JN_00 | 169 |
| LQM18NN_00 | 169 |
| LQM21NN_10 | 170 |
| LQW04CA_00 | 155 |
| LQW15CA_00 | 155 |
| LQW18CA_00 | 157 |

RF Inductors

| | |
|------------|-----|
| LQG15HN_02 | 183 |
| LQG15HS_02 | 185 |
| LQG18HN_00 | 188 |
| LQH31HN_03 | 261 |
| LQP02HQ_02 | 189 |
| LQP02TN_02 | 193 |
| LQP02TQ_02 | 196 |
| LQP03HQ_02 | 199 |
| LQP03PN_02 | 203 |
| LQP03TG_02 | 203 |
| LQP03TN_02 | 206 |
| LQP03TQ_02 | 210 |
| LQP15MN_02 | 214 |
| LQP18MN_02 | 215 |
| LQW03AW_00 | 216 |
| LQW04AN_00 | 218 |
| LQW04AN_10 | 222 |
| LQW15AN_00 | 223 |
| LQW15AN_10 | 228 |
| LQW15AN_80 | 230 |
| LQW15AW_80 | 236 |
| LQW15CN_00 | 258 |
| LQW15CN_10 | 258 |
| LQW18AN_00 | 237 |
| LQW18AN_10 | 240 |
| LQW18AN_80 | 241 |
| LQW18AS_00 | 245 |
| LQW18AS_0C | 247 |
| LQW18CN_00 | 260 |
| LQW21HN_00 | 261 |
| LQW2BAN_00 | 248 |
| LQW2BAS_00 | 250 |
| LQW2BHN_03 | 252 |
| LQW2BHN_13 | 254 |
| LQW2UAS_00 | 254 |
| LQW31HN_03 | 257 |

Global Locations

For details please visit www.murata.com



⚠ Note

1 Export Control

For customers outside Japan:

No Murata products should be used or sold, through any channels, for use in the design, development, production, utilization, maintenance or operation of, or otherwise contribution to (1) any weapons (Weapons of Mass Destruction [nuclear, chemical or biological weapons or missiles] or conventional weapons) or (2) goods or systems specially designed or intended for military end-use or utilization by military end-users.

For customers in Japan:

For products which are controlled items subject to the "Foreign Exchange and Foreign Trade Law" of Japan, the export license specified by the law is required for export.

2 Please contact our sales representatives or product engineers before using the products in this catalog for the applications listed below, which require especially high reliability for the prevention of defects which might directly damage a third party's life, body or property, or when one of our products is intended for use in applications other than those specified in this catalog.

- ① Aircraft equipment
- ② Aerospace equipment
- ③ Undersea equipment
- ④ Power plant equipment
- ⑤ Medical equipment
- ⑥ Transportation equipment (vehicles, trains, ships, etc.)
- ⑦ Traffic signal equipment
- ⑧ Disaster prevention / crime prevention equipment
- ⑨ Data-processing equipment
- ⑩ Application of similar complexity and/or reliability requirements to the applications listed above

3 Product specifications in this catalog are as of August 2018. They are subject to change or our products in it may be discontinued without advance notice. Please check with our sales representatives or product engineers before ordering. If there are any questions, please contact our sales representatives or product engineers.

4 Please read rating and ⚠CAUTION (for storage, operating, rating, soldering, mounting and handling) in this catalog to prevent smoking and/or burning, etc.

5 This catalog has only typical specifications. Therefore, please approve our product specifications or transact the approval sheet for product specifications before ordering.

6 Please note that unless otherwise specified, we shall assume no responsibility whatsoever for any conflict or dispute that may occur in connection with the effect of our and/or a third party's intellectual property rights and other related rights in consideration of your use of our products and/or information described or contained in our catalogs. In this connection, no representation shall be made to the effect that any third parties are authorized to use the rights mentioned above under licenses without our consent.

7 No ozone depleting substances (ODS) under the Montreal Protocol are used in our manufacturing process.



Murata Manufacturing Co., Ltd.

www.murata.com



muRata
INNOVATOR IN ELECTRONICS

Looking for pricing, stock, or lifecycle information?

Click below to explore more details on WIN SOURCE:

-  [View LQW18AN72NG00D on WIN SOURCE](#)
-  [Murata Electronics North America Information](#)

Optimize Your Supply Chain with WIN SOURCE Solutions

-  Global Sourcing Solution
-  Obsolete Management
-  Cost Control Management
-  Shortage Management
-  Alternative Solution
-  Excess Inventory Management