



**THE DATASHEET OF
LQW15CN96NJ00D**



Chip Inductors (Chip Coils)





EU RoHS Compliant

- All the products in this catalog comply with EU RoHS.
- EU RoHS is "the European Directive 2011/65/EU on the Restriction of the Use of Certain Hazardous Substances in Electrical and Electronic Equipment."
- For more details, please refer to our web page, "Murata's Approach for EU RoHS" (<https://www.murata.com/en-eu/support/compliance/rohs>).

Contents

Product specifications are as of August 2018.

Product Guide p2

Inductors for Power Lines

Part Numbering p8
Product Detail p10
⚠Caution/Notice p136
Soldering and Mounting p138
Packaging p146

Inductors for General Circuits

Part Numbering p154
Product Detail p155
⚠Caution/Notice p172
Soldering and Mounting p174
Packaging p178

RF Inductors

Part Numbering p182
Product Detail p183
⚠Caution/Notice p263
Soldering and Mounting p265
Packaging p269

Part Number Quick Reference p271

Please check the MURATA website (<https://www.murata.com/>) if you cannot find a part number in this catalog.

Product Guide

Series	Structure	Size Code in inch (in mm)	Inductance Range		Rated Current	
			Min.	Max.	Min.	Max.
DFE18SAN_E0	p10	0603 (1608)	240nH	1μH	2A	4.2A
DFE18SAN_GO	p10	0603 (1608)	240nH	1μH	2.1A	4.9A
DFE18SBN_E0	p11	0603 (1608)	470nH	1μH	1.9A	3.1A
DFE201208S	p12	0805 (2012)	470nH	2.2μH	1.8A	4A
DFE201210S	p13	0805 (2012)	470nH	2.2μH	2.1A	4.8A
DFE201210U	p13	0805 (2012)	240nH	2.2μH	2A	6.5A
DFE201610C	p14	0806 (2016)	560nH	2.2μH	1.5A	2.8A
DFE201610E	p15	0806 (2016)	240nH	10μH	1A	6.3A
DFE201610P	p16	0806 (2016)	240nH	2.2μH	2A	5.4A
DFE201610R	p16	0806 (2016)	470nH	2.2μH	1.6A	3A
DFE201612C	p17	0806 (2016)	470nH	2.2μH	1.6A	3.4A
DFE201612E	p18	0806 (2016)	240nH	4.7μH	1.8A	6.6A
DFE201612P	p19	0806 (2016)	240nH	2.2μH	2.1A	6.5A
DFE201612R	p19	0806 (2016)	470nH	2.2μH	1.7A	3.5A
DFE252007F	p20	1008 (2520)	470nH	4.7μH	1.2A	3.3A
DFE252008C	p21	1008 (2520)	470nH	4.7μH	1.1A	3A
DFE252008U	p22	1008 (2520)	470nH	10μH	1A	4.5A
DFE252010C	p22	1008 (2520)	470nH	10μH	1A	3.5A
DFE252010F	p23	1008 (2520)	330nH	10μH	1.3A	6.8A
DFE252010P	p24	1008 (2520)	330nH	4.7μH	1.7A	5.7A
DFE252010R	p25	1008 (2520)	1μH	4.7μH	1.4A	3A
DFE252012C	p26	1008 (2520)	470nH	10μH	1A	3.8A
DFE252012F	p26	1008 (2520)	330nH	10μH	1.4A	7.6A
DFE252012P	p27	1008 (2520)	330nH	4.7μH	2A	6.6A
DFE252012R	p28	1008 (2520)	1μH	4.7μH	1.7A	3.4A
DFE322510C	p29	1210 (3225)	470nH	10μH	1A	3.8A
DFE322512C	p30	1210 (3225)	470nH	10μH	1.2A	4.7A
DFE322512F	p30	1210 (3225)	470nH	10μH	1.7A	6.7A
FDSD0412	p31	1515 (4040)	330nH	4.7μH	2.5A	7.5A
FDSD0415	p32	1515 (4040)	220nH	4.7μH	2.9A	12A
FDSD0420	p33	1515 (4040)	330nH	10μH	2.5A	11A
FDSD0420W	p34	1515 (4040)	15μH	22μH	1.5A	1.9A
FDSD0512	p34	2019 (5249)	1μH	6.8μH	2.3A	6.1A
FDSD0515	p35	2019 (5249)	1μH	4.7μH	3.2A	7A
FDSD0518	p36	2019 (5249)	680nH	10μH	2.7A	9A
FDV0530S	p37	2020 (5050)	120nH	2.2μH	4.5A	18A
FDV0530	p37	2423 (6258)	110nH	4.7μH	3.6A	19.6A
FCUL0530	p38	2522 (6357)	360nH	470nH	16A	18A
FDSD0630	p39	2726 (7066)	680nH	10μH	5.4A	17A
FCUL0624	p40	2926 (7366)	220nH	470nH	17A	24A
FCUL0630	p40	2926 (7366)	120nH	680nH	15A	32A
FDV0618	p41	2926 (7467)	240nH	3.3μH	4.1A	14A
FDV0620	p42	2926 (7467)	200nH	4.7μH	3.5A	16.2A
FDVE0630	p43	2926 (7467)	160nH	10μH	3.1A	20.7A
FDVE0640	p44	2926 (7467)	1.5μH	4.7μH	5A	8.2A
FDUE0630	p44	3026 (7667)	120nH	240nH	27A	36A
FDUE0640	p45	3026 (7667)	150nH	420nH	22A	33A
FDUE0650	p46	3026 (7667)	600nH	1μH	16A	18A
FDA1055	p46	4242 (108108)	560nH	5.6μH	8A	27.7A
FDUE1040D	p47	4440 (112100)	220nH	1μH	18A	32A
FDVE1040	p48	4440 (112100)	1.5μH	10μH	6.1A	14.6A
FCUL1040	p49	4540 (115100)	180nH	420nH	34A	53A
FCUL1060	p49	4640 (116100)	360nH	560nH	34A	41A
FDUE1245	p50	4848 (123121)	500nH	2.2μH	17A	30A

Inductors for Power Lines

Wire Wound
 Metal Alloy
 Core Type

Continued on the following page. ↗

Series	Structure	Size Code in inch (in mm)	Inductance Range		Rated Current	
			Min.	Max.	Min.	Max.
FDA1254	Wire Wound Metal Alloy Core Type	5049 (126125)	680nH	8μH	9.1A	29.1A
FDUE1260		5650 (143127)	450nH	450nH	34A	34A
LQW15DN_00	Wire Wound Ferrite Core Type	0402 (1005)	10μH	15μH	100mA	120mA
LQH2MCN_02		0806 (2016)	1μH	82μH	90mA	485mA
LQH2MCN_52		0806 (2016)	1μH	22μH	130mA	595mA
LQH2MPN_GR		0806 (2016)	330nH	82μH	210mA	2.2A
LQH2HPN_DR		1008 (2520)	470nH	22μH	270mA	1.67A
LQH2HPN_GR		1008 (2520)	470nH	100μH	210mA	2.9A
LQH2HPN_JR		1008 (2520)	470nH	22μH	540mA	3.5A
LQH31CN_03		1206 (3216)	120nH	100μH	80mA	970mA
LQH32CN_23		1210 (3225)	1μH	560μH	60mA	800mA
LQH32CN_33		1210 (3225)	150nH	10μH	450mA	1.45A
LQH32CN_53		1210 (3225)	1μH	100μH	100mA	1A
LQH32DN_23		1210 (3225)	1μH	560μH	60mA	800mA
LQH32DN_53		1210 (3225)	1μH	100μH	100mA	1A
LQH32PB_NO		1210 (3225)	470nH	120μH	200mA	3.4A
LQH32PB_NC		1210 (3225)	470nH	22μH	650mA	4.4A
LQH32PN_NO		1210 (3225)	470nH	120μH	200mA	3.4A
LQH32PN_NC		1210 (3225)	470nH	22μH	650mA	4.4A
DEM2812C		1211 (3028)	470nH	12μH	760mA	3.1A
DEM2815C		1211 (3028)	470nH	15μH	800mA	3.9A
DEM2818C		1211 (3028)	470nH	12μH	1A	4.7A
LQH3NPN_GR		1212 (3030)	470nH	250μH	140mA	2.82A
LQH3NPN_JR		1212 (3030)	680nH	47μH	570mA	2.86A
LQH3NPN_ME		1212 (3030)	1μH	100μH	430mA	3A
DEM3512C		1514 (3735)	680nH	22μH	530mA	2.5A
DEM3518C		1514 (3735)	560nH	22μH	880mA	3.4A
LQH44PN_GR		1515 (4040)	680nH	47μH	410mA	2.5A
LQH44PN_JO		1515 (4040)	1μH	47μH	380mA	2A
LQH44PN_PO		1515 (4040)	1μH	22μH	800mA	2.95A
LQH43CN_03		1812 (4532)	1μH	470μH	90mA	1.08A
LQH43CN_33		1812 (4532)	560nH	3.9μH	1.6A	2.95A
LQH43PB_26		1812 (4532)	1μH	220μH	240mA	3.4A
LQH43PN_26		1812 (4532)	1μH	220μH	240mA	3.4A
DEM4518C	1818 (4745)	1.2μH	22μH	1A	3.5A	
LQH5BPB_TO	2020 (5050)	470nH	22μH	1.4A	7.7A	
LQH5BPN_38	2020 (5050)	1μH	150μH	650mA	7A	
LQH5BPN_TO	2020 (5050)	470nH	22μH	1.4A	7.7A	
D52LC	2020 (5252)	1.2μH	100μH	260mA	2.44A	
D53LC High Current	2020 (5252)	1.1μH	100μH	440mA	3.87A	
D53LC Low Rdc	2020 (5252)	4.7μH	220μH	330mA	2.18A	
LQH55DN_03	2220 (5750)	120nH	10mH	50mA	6A	
D63LCB	2424 (6060)	1μH	150μH	440mA	4.52A	
DG6028C	2424 (6060)	1μH	22μH	1.7A	5.8A	
DG6045C	2424 (6060)	1μH	100μH	900mA	9.5A	
DG6050C	2424 (6060)	1.2μH	100μH	1.2A	9.8A	
LQH66SN_03	2525 (6363)	270nH	10mH	50mA	6A	
DS75LC	2929 (7373)	1μH	470μH	430mA	9.2A	
DEM8030C	3131 (8080)	1.5μH	47μH	1.3A	7.5A	
DEM8040C	3131 (8080)	1.5μH	33μH	2.4A	10A	
DEM8045C	3131 (8080)	1.5μH	47μH	2.1A	11.2A	
DG8040C	3131 (8080)	1μH	100μH	1.3A	10.4A	
DEM10050C	3939 (100100)	1.5μH	33μH	3.5A	15.3A	
DEM10050C_DD	3939 (100100)	1.5μH	33μH	3.5A	15.3A	

Continued on the following page. ↗

	Series	Structure	Size Code in inch (in mm)	Inductance Range		Rated Current	
				Min.	Max.	Min.	Max.
Inductors for Power Lines	DS104C2	Wire Wound Ferrite Core Type	4040 (101101)	1.1μH	120μH	970mA	11.7A
	DS106C2		4040 (101101)	1.2μH	330μH	690mA	12A
	DS126C2		4949 (125125)	1.7μH	680μH	580mA	11.8A
	LQM18FN_00	Multilayer Type	0603 (1608)	1μH	10μH	50mA	150mA
	LQM18PN_B0		0603 (1608)	1.5μH	1.5μH	600mA	600mA
	LQM18PN_C0		0603 (1608)	470nH	2.2μH	700mA	850mA
	LQM18PN_D0		0603 (1608)	2.5μH	2.5μH	700mA	700mA
	LQM18PN_DH		0603 (1608)	2.2μH	2.2μH	650mA	650mA
	LQM18PN_F0		0603 (1608)	1μH	1μH	600mA	600mA
	LQM18PN_FH		0603 (1608)	470nH	2.2μH	700mA	1.4A
	LQM18PN_FR		0603 (1608)	220nH	4.7μH	620mA	1.25A
	LQM18PN_GH		0603 (1608)	1μH	3.3μH	1.05A	1.05A
	LQM18PW_CH		0603 (1608)	1μH	2.5μH	750mA	950mA
	LQM21DN_00		0805 (2012)	1μH	47μH	7mA	60mA
	LQM21FN_00		0805 (2012)	1μH	47μH	7mA	220mA
	LQM21FN_70		0805 (2012)	4.7μH	10μH	100mA	120mA
	LQM21FN_80		0805 (2012)	4.7μH	10μH	100mA	120mA
	LQM21PN_C0		0805 (2012)	470nH	2.2μH	600mA	1.1A
	LQM21PN_CA		0805 (2012)	2.2μH	2.2μH	1.05A	1.05A
	LQM21PN_CH		0805 (2012)	470nH	2.2μH	1.05A	1.6A
	LQM21PN_EH		0805 (2012)	240nH	2.2μH	1.1A	2.8A
	LQM21PN_G0		0805 (2012)	470nH	3.3μH	800mA	1.3A
	LQM21PN_GC		0805 (2012)	1μH	2.2μH	800mA	900mA
	LQM21PN_GH		0805 (2012)	470nH	4.7μH	1A	2.4A
	LQM21PN_GR		0805 (2012)	1μH	4.7μH	800mA	1.3A
	LQM21PN_GS		0805 (2012)	2.2μH	4.7μH	750mA	950mA
	LQM2MPN_DH		0806 (2016)	2.2μH	2.2μH	1.27A	1.27A
	LQM2MPN_EH		0806 (2016)	240nH	2.2μH	1.1A	4.1A
	LQM2MPN_G0		0806 (2016)	470nH	4.7μH	1.1A	1.6A
	LQM2MPN_GH		0806 (2016)	160nH	2.2μH	1.3A	5A
	LQM2HPN_CH		1008 (2520)	240nH	2.2μH	850mA	2.55A
	LQM2HPN_E0		1008 (2520)	560nH	560nH	1.5A	1.5A
	LQM2HPN_EH		1008 (2520)	240nH	2.2μH	1.3A	4.5A
	LQM2HPN_G0	1008 (2520)	470nH	4.7μH	1.1A	1.8A	
	LQM2HPN_GC	1008 (2520)	1μH	4.7μH	800mA	1.5A	
LQM2HPN_GH	1008 (2520)	240nH	2.2μH	1.5A	5A		
LQM2HPN_GS	1008 (2520)	2.2μH	4.7μH	1A	1.1A		
LQM2HPN_J0	1008 (2520)	1μH	3.3μH	1A	1.5A		
LQM2HPN_JH	1008 (2520)	470nH	2.2μH	1.5A	3.2A		
LQM31PN_00	1206 (3216)	470nH	4.7μH	700mA	1.4A		
LQM32PN_G0	1210 (3225)	1μH	1μH	1.8A	1.8A		
LQM32PN_GC	1210 (3225)	1μH	1μH	2.2A	2.2A		
RF Inductors	LQG15HN_02	Multilayer Type	0402 (1005)	1nH	120nH	150mA	1A
	LQG15HS_02		0402 (1005)	1nH	270nH	110mA	1A
	LQG18HN_00	Film Type	0603 (1608)	1.2nH	100nH	350mA	1.1A
	LQP02HQ_02		01005 (0402)	0.2nH	56nH	100mA	1A
	LQP02TN_02		01005 (0402)	0.2nH	39nH	90mA	320mA
	LQP02TQ_02		01005 (0402)	0.2nH	22nH	120mA	990mA
	LQP03HQ_02		0201 (0603)	0.6nH	150nH	80mA	1.1A
	LQP03PN_02		0201 (0603)	2.2nH	4.7nH	900mA	1.4A
	LQP03TG_02		0201 (0603)	0.1nH	120nH	80mA	850mA
	LQP03TN_02		0201 (0603)	0.6nH	270nH	60mA	850mA
	LQP03TQ_02		0201 (0603)	0.6nH	110nH	70mA	1A
	LQP15MN_02		0402 (1005)	1nH	33nH	60mA	400mA

Continued on the following page. ↗

	Series	Structure	Size Code in inch (in mm)	Inductance Range		Rated Current		
				Min.	Max.	Min.	Max.	
RF Inductors	LQP18MN_02	p215	Film Type	0603 (1608)	1.3nH	100nH	50mA	300mA
	LQW03AW_00	p216	Wire Wound Non-Magnetic Core Type	0201 (0603)	1nH	15.5nH	230mA	900mA
	LQW04AN_00	p218		03015 (0804)	0.8nH	33nH	140mA	1.8A
	LQW04AN_10	p222		03015 (0804)	36nH	56nH	180mA	200mA
	LQW15AN_00	p223		0402 (1005)	1.5nH	120nH	110mA	1A
	LQW15AN_10	p228		0402 (1005)	1.3nH	8.4nH	640mA	1.2A
	LQW15AN_80	p230		0402 (1005)	1.3nH	75nH	320mA	3.15A
	LQW15AW_80	p236		0402 (1005)	51nH	220nH	220mA	480mA
	LQW18AN_00	p237		0603 (1608)	2.2nH	470nH	75mA	850mA
	LQW18AN_10	p240		0603 (1608)	2.2nH	33nH	550mA	1.4A
	LQW18AN_80	p241		0603 (1608)	2.2nH	390nH	190mA	3.2A
	LQW18AS_00	p245		0603 (1608)	1.6nH	390nH	100mA	700mA
	LQW18AS_0C	p247		0603 (1608)	4.3nH	390nH	100mA	700mA
	LQW2BAN_00	p248		0805 (2015)	3.2nH	200nH	750mA	3.8A
	LQW2BAS_00	p250		0805 (2015)	2.7nH	1μH	170mA	910mA
	LQW2BHN_03	p252		0805 (2015)	3.3nH	470nH	160mA	1.32A
	LQW2BHN_13	p254		0805 (2015)	2.7nH	27nH	900mA	1.9A
	LQW2UAS_00	p254		1008 (2520)	12nH	4.7μH	260mA	1A
	LQW31HN_03	p257		1206 (3216)	8.8nH	100nH	230mA	750mA
	Inductors for General Circuits	LQW15CN_00		p258	Wire Wound Ferrite Core Type	0402 (1005)	18nH	200nH
LQW15CN_10		p258	0402 (1005)	20nH		3.3μH	130mA	2.2A
LQW18CN_00		p260	0603 (1608)	4.9nH		650nH	430mA	2.6A
LQW21HN_00		p261	0805 (2012)	470nH		2.2μH	75mA	160mA
LQH31HN_03		p261	1206 (3216)	54nH		880nH	180mA	920mA
Inductors for General Circuits	LQW04CA_00	p155	Wire Wound Ferrite Core Type	03019 (0805)	60nH	510nH	200mA	620mA
	LQW15CA_00	p155		0402 (1005)	22nH	2μH	130mA	1.3A
	LQW18CA_00	p157		0603 (1608)	32nH	580nH	450mA	2.2A
	LQH31MN_03	p158		1206 (3216)	150nH	100μH	45mA	250mA
	LQH32MN_23	p160		1210 (3225)	1μH	560μH	40mA	445mA
	LQH44NN_03	p162		1515 (4040)	510nH	470μH	145mA	4.5A
	LQH43MN_03	p163		1812 (4532)	1μH	1.5mH	40mA	500mA
	LQH43NN_03	p165		1812 (4532)	1μH	2.4mH	25mA	500mA
	LQB15NN_10	p167	Multilayer Type	0402 (1005)	220nH	560nH	300mA	380mA
	LQB18NN_10	p168		0603 (1608)	220nH	560nH	300mA	450mA
LQM18JN_00	p169	0603 (1608)		100nH	160nH	550mA	650mA	
LQM18NN_00	p169		0603 (1608)	47nH	2.2μH	15mA	50mA	
LQM21NN_10	p170		0805 (2012)	100nH	4.7μH	30mA	250mA	

Inductors for Power Lines

Part Numbering	p8
Product Detail	p10
⚠Caution/Notice	p136
Soldering and Mounting	p138
Packaging	p146

● Part Numbering

Inductors for Power Lines



① Product ID

Product ID	
LQ	Chip Inductors (Chip Coils)

② Structure

Code	Structure
H	Wire Wound Type (Ferrite Core)
M	Multilayer Type (Ferrite Core)
W	Wire Wound Type (Ferrite Core)

③ Dimensions (LxW)

Code	Nominal Dimensions (LxW)	Size Code (in inch)
15	1.0x0.5mm	0402
18	1.6x0.8mm	0603
21	2.0x1.25mm	0805
2M	2.0x1.6mm	0806
2H	2.5x2.0mm	1008
3N	3.0x3.0mm	1212
31	3.2x1.6mm	1206
32	3.2x2.5mm	1210
43	4.5x3.2mm	1812
44	4.0x4.0mm	1515
5B	5.0x5.0mm	2020
55	5.7x5.0mm	2220
66	6.3x6.3mm	2525

④ Applications and Characteristics

Code	Series	Applications and Characteristics
D	LQM	for Choke (Low-current DC Power Supplies)
F		for Choke (DC Power Supplies)
D	LQH	for Choke
S		for Choke (Magnetically Shielded Type)
C		for Choke (Coating Type)
P	LQM/LQH	for Power Line
D	LQW	

⑤ Category

Code	Category
N	Standard Type
B	Special Feature Classification
W	

⑥ Inductance

Expressed by three-digit alphanumeric. The unit is micro-henry (μH). The first and second figures are significant digits, and the third figure expresses the number of zeros that follow the two figures. If there is a decimal point, it is expressed by the capital letter "R." In this case, all figures are significant digits. If inductance is less than $0.1\mu\text{H}$, the inductance code is expressed by a combination of two figures and the capital letter "N," and the unit of inductance is nano-henry (nH). The capital letter "N" indicates the unit of "nH," and also expresses a decimal point. In this case, all figures are significant digits. For those products whose inductance values are specified using three designated digits, these values may be indicated using the closest two digits instead.

⑦ Inductance Tolerance

Code	Inductance Tolerance
K	$\pm 10\%$
M	$\pm 20\%$
N	$\pm 30\%$

⑧ Features (Except for LQH□□P/LQM□□P)

Code	Features	Series
0	Standard Type	LQM/LQH/LQW
2	Standard Type	LQH32C/32D
3	Low DC Resistance	LQH32C/43CN
5	Low Profile Type	LQH2MC/32C/32D
7	Large Current Type	LQM21F
8	Low DC Resistance /Large Current Type	

⑨ Thickness

(LQH□□P/LQM□□P Only • Except for LQH43P/LQH5BPN_38)

Code	Nominal Dimensions (T)
B	0.35mm
C	0.5mm
D	0.6mm
E	0.7mm
F	0.8mm
O	0.85mm
G	0.9mm
J	1.1mm
M	1.4mm
N	1.55mm
P	1.65mm
T	2.0mm

Continued on the following page. ↗

Continued from the preceding page. ↘

⑨ Electrode (Except for LQH□□P/LQM□□P)

•Lead (Pb) Free

Code	Electrode	Series
0	Sn	LQM/LQW
2		LQH2MC
3	LF Solder	LQH (Except for LQH2MC)

⑩ Specification

(LQH□□P/LQM□□P Only • Except for LQH43P/LQH5BPN_38)

Code	Specification
0/S	Standard Type
C	Good Bias Current Characteristics Type
H/A/E	High Spec Type (Low DC Resistance; Good Bias Current Characteristics Type)
R	Low DC Resistance Type

⑪ Thickness (LQH43P/LQH5BPN_38 Only)

Code	Dimensions (T)
26	2.6mm
38	4.0mm max.

⑫ Packaging

Code	Packaging
K	Embossed Taping (ø330mm Reel)
F	
L	Embossed Taping (ø180mm Reel)
E	
B	Bulk
J	Paper Taping (ø330mm Reel)
D	Paper Taping (ø180mm Reel)

Inductors for Power Lines

DFE18SAN_E0 Series 0603 (1608) inch (mm)



Packaging Code	Packaging	Minimum Quantity
L	ø180mm Embossed Taping	3000

Part Number (□: packaging code)	Inductance	Inductance Test Frequency	Rated Current (Isat)*	Rated Current (Itemp)*	Max. of DC Resistance
DFE18SANR24ME0□	0.24μH ±20%	1MHz	4200mA	3200mA	0.036Ω
DFE18SANR47ME0□	0.47μH ±20%	1MHz	3100mA	2400mA	0.064Ω
DFE18SANR56ME0□	0.56μH ±20%	1MHz	2600mA	2200mA	0.070Ω
DFE18SAN1R0ME0□	1.0μH ±20%	1MHz	2000mA	1600mA	0.144Ω

Absolute maximum voltage: 20V DC

Operating temp. range (Self-temp. rise included): -40 to 125°C

Operating temp. range (Self-temp. rise not included): -40 to 85°C

Class of Magnetic Shield: Metal Alloy

Only for reflow soldering

*Isat: Rated Current based on Inductance change

*Itemp: Rated Current based on Temperature rise

The saturation allowable DC current value is specified when the decrease of the initial inductance value at 30%. When rated current is applied to the products, the temperature rise caused by self-generated heat shall be limited to 40°C max. Keep the temperature (ambient temperature plus self-generation of heat) under 125°C.

Inductance-Frequency Characteristics (Typ.)



Inductance-Current Characteristics (Typ.)



Temperature Rise Characteristics (Typ.)



DFE18SAN_G0 Series 0603 (1608) inch (mm)



Packaging Code	Packaging	Minimum Quantity
L	ø180mm Embossed Taping	3000

Continued on the following page. ↗

Continued from the preceding page. ↘

Part Number (□: packaging code)	Inductance	Inductance Test Frequency	Rated Current (Isat)*	Rated Current (Itemp)*	Max. of DC Resistance
DFE18SANR24MG0□	0.24μH ±20%	1MHz	4900mA	3500mA	0.030Ω
DFE18SANR47MG0□	0.47μH ±20%	1MHz	3300mA	2600mA	0.054Ω
DFE18SAN1ROMG0□	1.0μH ±20%	1MHz	2100mA	1700mA	0.128Ω

Absolute maximum voltage: 20V DC

Operating temp. range (Self-temp. rise included): -40 to 125°C

Operating temp. range (Self-temp. rise not included): -40 to 85°C

Class of Magnetic Shield: Metal Alloy

Only for reflow soldering

*Isat: Rated Current based on Inductance change

*Itemp: Rated Current based on Temperature rise

The saturation allowable DC current value is specified when the decrease of the initial inductance value at 30%. When rated current is applied to the products, the temperature rise caused by self-generated heat shall be limited to 40°C max. Keep the temperature (ambient temperature plus self-generation of heat) under 125°C.

Inductance-Frequency Characteristics (Typ.)



Inductance-Current Characteristics (Typ.)



Temperature Rise Characteristics (Typ.)



DFE18SBN_E0 Series 0603 (1608) inch (mm)



Packaging Code	Packaging	Minimum Quantity
L	ø180mm Embossed Taping	3000

Part Number (□: packaging code)	Inductance	Inductance Test Frequency	Rated Current (Isat)*	Rated Current (Itemp)*	Max. of DC Resistance
DFE18SBNR47ME0□	0.47μH ±20%	1MHz	3100mA	2400mA	0.06Ω
DFE18SBN1ROME0□	1.0μH ±20%	1MHz	1900mA	1800mA	0.12Ω

Absolute maximum voltage: 20V DC

Operating temp. range (Self-temp. rise included): -40 to 125°C

Operating temp. range (Self-temp. rise not included): -40 to 85°C

Class of Magnetic Shield: Metal Alloy

Only for reflow soldering

*Isat: Rated Current based on Inductance change

*Itemp: Rated Current based on Temperature rise

The saturation allowable DC current value is specified when the decrease of the initial inductance value at 30%. When rated current is applied to the products, the temperature rise caused by self-generated heat shall be limited to 40°C max. Keep the temperature (ambient temperature plus self-generation of heat) under 125°C.

Continued on the following page. ↗

Continued from the preceding page. ↘

Inductance-Frequency Characteristics (Typ.)



Inductance-Current Characteristics (Typ.)



Temperature Rise Characteristics (Typ.)



DFE201208S Series 0805 (2012) inch (mm)



(in mm)

Packaging Code	Packaging	Minimum Quantity
=P2	ø180mm Embossed Taping	3000

Part Number (□: packaging code)	Inductance	Inductance Test Frequency	Rated Current (Isat)*	Rated Current (Itemp)*	Max. of DC Resistance
DFE201208S-R47M□	0.47μH ±20%	1MHz	4000mA	3000mA	0.042Ω
DFE201208S-1R0M□	1.0μH ±20%	1MHz	2700mA	2100mA	0.084Ω
DFE201208S-1R5M□	1.5μH ±20%	1MHz	2300mA	1800mA	0.120Ω
DFE201208S-2R2M□	2.2μH ±20%	1MHz	1800mA	1400mA	0.204Ω

Absolute maximum voltage: 20V DC

Operating temp. range (Self-temp. rise included): -40 to 125°C

Class of Magnetic Shield: Metal Alloy

Only for reflow soldering

*Isat: Rated Current based on Inductance change

*Itemp: Rated Current based on Temperature rise

Rated current (Isat) is specified when the decrease of the initial inductance value at 30%. Rated current (Itemp) is specified when temperature of the inductor is raised 40°C by DC current.

Inductance-Frequency Characteristics (Typ.)



Inductance-Current Characteristics (Typ.)



Temperature Rise Characteristics (Typ.)



DFE201210S Series 0805 (2012) inch (mm)



(in mm)

Packaging Code	Packaging	Minimum Quantity
=P2	ø180mm Embossed Taping	3000

Part Number (□: packaging code)	Inductance	Inductance Test Frequency	Rated Current (Isat)*	Rated Current (Itemp)*	Max. of DC Resistance
DFE201210S-R47M□	0.47μH ±20%	1MHz	4800mA	3400mA	0.032Ω
DFE201210S-1R0M□	1.0μH ±20%	1MHz	3200mA	2300mA	0.070Ω
DFE201210S-1R5M□	1.5μH ±20%	1MHz	2700mA	2000mA	0.096Ω
DFE201210S-2R2M□	2.2μH ±20%	1MHz	2100mA	1500mA	0.155Ω

Absolute maximum voltage: 20V DC

Operating temp. range (Self-temp. rise included): -40 to 125°C

Class of Magnetic Shield: Metal Alloy

Only for reflow soldering

*Isat: Rated Current based on Inductance change

*Itemp: Rated Current based on Temperature rise

Rated current (Isat) is specified when the decrease of the initial inductance value at 30%. Rated current (Itemp) is specified when temperature of the inductor is raised 40°C by DC current.

Inductance-Frequency Characteristics (Typ.)



Inductance-Current Characteristics (Typ.)



Temperature Rise Characteristics (Typ.)



DFE201210U Series 0805 (2012) inch (mm)



(in mm)

Packaging Code	Packaging	Minimum Quantity
=P2	ø180mm Embossed Taping	3000

Continued on the following page. ↗

DFE201210S
Inductors for Power Lines

Inductors for General Circuits

RF Inductors

Continued from the preceding page. ↘

Part Number (□: packaging code)	Inductance	Inductance Test Frequency	Rated Current (Isat)*	Rated Current (Itemp)*	Max. of DC Resistance
DFE201210U-R24M□	0.24μH ±20%	1MHz	6500mA	3800mA	0.025Ω
DFE201210U-R33M□	0.33μH ±20%	1MHz	5200mA	3400mA	0.031Ω
DFE201210U-R47M□	0.47μH ±20%	1MHz	4400mA	3000mA	0.042Ω
DFE201210U-R68M□	0.68μH ±20%	1MHz	3600mA	2400mA	0.060Ω
DFE201210U-1R0M□	1.0μH ±20%	1MHz	3100mA	2000mA	0.095Ω
DFE201210U-1R5M□	1.5μH ±20%	1MHz	2500mA	1600mA	0.138Ω
DFE201210U-2R2M□	2.2μH ±20%	1MHz	2000mA	1200mA	0.228Ω

Absolute maximum voltage: 20V DC

Operating temp. range (Self-temp. rise included): -40 to 125°C

Class of Magnetic Shield: Metal Alloy

Only for reflow soldering

*Isat: Rated Current based on Inductance change

*Itemp: Rated Current based on Temperature rise

Rated current (Isat) is specified when the decrease of the initial inductance value at 30%. Rated current (Itemp) is specified when temperature of the inductor is raised 40°C by DC current.

Inductance-Frequency Characteristics (Typ.)



Inductance-Current Characteristics (Typ.)



Temperature Rise Characteristics (Typ.)



DFE201610C Series 0806 (2016) inch (mm)



(in mm)

Packaging Code	Packaging	Minimum Quantity
=P2	ø180mm Embossed Taping	3000

Part Number (□: packaging code)	Inductance	Inductance Test Frequency	Rated Current (Isat)*	Rated Current (Itemp)*	Max. of DC Resistance
1285AS-H-R56M□	0.56μH ±20%	1MHz	2800mA	2800mA	0.059Ω
1285AS-H-R68M□	0.68μH ±20%	1MHz	2600mA	2500mA	0.072Ω
1285AS-H-1R0M□	1.0μH ±20%	1MHz	2200mA	2000mA	0.096Ω
1285AS-H-1R5M□	1.5μH ±20%	1MHz	1800mA	1600mA	0.144Ω
1285AS-H-2R2M□	2.2μH ±20%	1MHz	1500mA	1200mA	0.204Ω

Absolute maximum voltage: 20V DC

Operating temp. range (Self-temp. rise included): -40 to 85°C

Class of Magnetic Shield: Metal Alloy

Only for reflow soldering

*Isat: Rated Current based on Inductance change

*Itemp: Rated Current based on Temperature rise

Rated current (Isat) is specified when the decrease of the initial inductance value at 30%. Rated current (Itemp) is specified when temperature of the inductor is raised 40°C by DC current.

Continued on the following page. ↗

Continued from the preceding page. ↘

Inductance-Frequency Characteristics (Typ.)



Inductance-Current Characteristics (Typ.)



Temperature Rise Characteristics (Typ.)



DFE201610E Series 0806 (2016) inch (mm)



Packaging Code	Packaging	Minimum Quantity
=P2	ø180mm Embossed Taping	3000

Part Number (□: packaging code)	Inductance	Inductance Test Frequency	Rated Current (Isat)*	Rated Current (Itemp)*	Max. of DC Resistance
DFE201610E-R24M□	0.24µH ±20%	1MHz	6300mA	4700mA	0.020Ω
DFE201610E-R33M□	0.33µH ±20%	1MHz	5500mA	4000mA	0.026Ω
DFE201610E-R47M□	0.47µH ±20%	1MHz	4800mA	3600mA	0.032Ω
DFE201610E-R68M□	0.68µH ±20%	1MHz	4300mA	3100mA	0.043Ω
DFE201610E-1R0M□	1.0µH ±20%	1MHz	3600mA	2700mA	0.057Ω
DFE201610E-1R5M□	1.5µH ±20%	1MHz	2900mA	2100mA	0.091Ω
DFE201610E-2R2M□	2.2µH ±20%	1MHz	2400mA	1700mA	0.140Ω
DFE201610E-4R7M□	4.7µH ±20%	1MHz	1600mA	1100mA	0.288Ω
DFE201610E-100M□	10µH ±20%	1MHz	1000mA	650mA	0.780Ω

Absolute maximum voltage: 20V DC

Operating temp. range (Self-temp. rise included): -40 to 125°C

Class of Magnetic Shield: Metal Alloy

Only for reflow soldering

*Isat: Rated Current based on Inductance change

*Itemp: Rated Current based on Temperature rise

Rated current (Isat) is specified when the decrease of the initial inductance value at 30%. Rated current (Itemp) is specified when temperature of the inductor is raised 40°C by DC current.

Inductance-Frequency Characteristics (Typ.)



Inductance-Current Characteristics (Typ.)

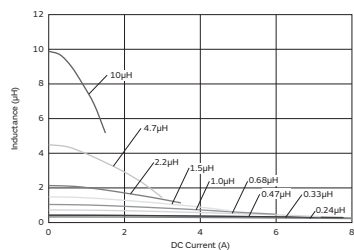

Temperature Rise Characteristics (Typ.)



DFE201610P Series 0806 (2016) inch (mm)



Packaging Code	Packaging	Minimum Quantity
=P2	ø180mm Embossed Taping	3000

Part Number (□: packaging code)	Inductance	Inductance Test Frequency	Rated Current (Isat)*	Rated Current (Itemp)*	Max. of DC Resistance
DFE201610P-R24M□	0.24μH ±20%	1MHz	5400mA	3800mA	0.026Ω
DFE201610P-R33M□	0.33μH ±20%	1MHz	4700mA	3500mA	0.034Ω
DFE201610P-R47M□	0.47μH ±20%	1MHz	4000mA	3100mA	0.040Ω
DFE201610P-R68M□	0.68μH ±20%	1MHz	3600mA	2700mA	0.048Ω
DFE201610P-1R0M□	1.0μH ±20%	1MHz	3100mA	2200mA	0.070Ω
DFE201610P-1R5M□	1.5μH ±20%	1MHz	2500mA	1800mA	0.110Ω
DFE201610P-2R2M□	2.2μH ±20%	1MHz	2000mA	1400mA	0.168Ω

Absolute maximum voltage: 20V DC

Operating temp. range (Self-temp. rise included): -40 to 125°C

Class of Magnetic Shield: Metal Alloy

Only for reflow soldering

*Isat: Rated Current based on Inductance change

*Itemp: Rated Current based on Temperature rise

Rated current (Isat) is specified when the decrease of the initial inductance value at 30%. Rated current (Itemp) is specified when temperature of the inductor is raised 40°C by DC current.

Inductance-Frequency Characteristics (Typ.)



Inductance-Current Characteristics (Typ.)



Temperature Rise Characteristics (Typ.)



DFE201610R Series 0806 (2016) inch (mm)



Packaging Code	Packaging	Minimum Quantity
=P2	ø180mm Embossed Taping	3000

Continued on the following page. ↗

Continued from the preceding page. ↘

Part Number (□: packaging code)	Inductance	Inductance Test Frequency	Rated Current (Isat)*	Rated Current (Itemp)*	Max. of DC Resistance
DFE201610R-H-R47M□	0.47μH ±20%	1MHz	3000mA	2800mA	0.048Ω
DFE201610R-H-1R0M□	1.0μH ±20%	1MHz	2200mA	2100mA	0.079Ω
DFE201610R-H-1R5M□	1.5μH ±20%	1MHz	1800mA	1800mA	0.118Ω
DFE201610R-H-2R2M□	2.2μH ±20%	1MHz	1600mA	1400mA	0.168Ω

Absolute maximum voltage: 20V DC

Operating temp. range (Self-temp. rise included): -40 to 85°C

Class of Magnetic Shield: Metal Alloy

Only for reflow soldering

*Isat: Rated Current based on Inductance change

*Itemp: Rated Current based on Temperature rise

Rated current (Isat) is specified when the decrease of the initial inductance value at 30%. Rated current (Itemp) is specified when temperature of the inductor is raised 40°C by DC current.

Inductance-Frequency Characteristics (Typ.)



Inductance-Current Characteristics (Typ.)



Temperature Rise Characteristics (Typ.)



DFE201612C Series 0806 (2016) inch (mm)



Packaging Code	Packaging	Minimum Quantity
=P2	ø180mm Embossed Taping	3000

Part Number (□: packaging code)	Inductance	Inductance Test Frequency	Rated Current (Isat)*	Rated Current (Itemp)*	Max. of DC Resistance
1286AS-H-R47M□	0.47μH ±20%	1MHz	3400mA	3200mA	0.052Ω
1286AS-H-1R0M□	1.0μH ±20%	1MHz	2500mA	2300mA	0.082Ω
1286AS-H-1R5M□	1.5μH ±20%	1MHz	2000mA	1800mA	0.114Ω
1286AS-H-2R2M□	2.2μH ±20%	1MHz	1600mA	1300mA	0.192Ω

Absolute maximum voltage: 20V DC

Operating temp. range (Self-temp. rise included): -40 to 85°C

Class of Magnetic Shield: Metal Alloy

Only for reflow soldering

*Isat: Rated Current based on Inductance change

*Itemp: Rated Current based on Temperature rise

Rated current (Isat) is specified when the decrease of the initial inductance value at 30%. Rated current (Itemp) is specified when temperature of the inductor is raised 40°C by DC current.

Continued on the following page. ↗

DFE201612C
 Inductors for Power Lines

Inductors for General Circuits

RF Inductors

Continued from the preceding page. ↘

Inductance-Frequency Characteristics (Typ.)



Inductance-Current Characteristics (Typ.)



Temperature Rise Characteristics (Typ.)



DFE201612E Series 0806 (2016) inch (mm)



(in mm)

Packaging Code	Packaging	Minimum Quantity
=P2	ø180mm Embossed Taping	3000

Part Number (□: packaging code)	Inductance	Inductance Test Frequency	Rated Current (Isat)*	Rated Current (Itemp)*	Max. of DC Resistance
DFE201612E-R24M□	0.24µH ±20%	1MHz	6600mA	5000mA	0.019Ω
DFE201612E-R33M□	0.33µH ±20%	1MHz	6300mA	4800mA	0.021Ω
DFE201612E-R47M□	0.47µH ±20%	1MHz	5500mA	4500mA	0.026Ω
DFE201612E-R68M□	0.68µH ±20%	1MHz	4300mA	3500mA	0.033Ω
DFE201612E-1R0M□	1.0µH ±20%	1MHz	4000mA	2900mA	0.048Ω
DFE201612E-1R5M□	1.5µH ±20%	1MHz	3200mA	2300mA	0.072Ω
DFE201612E-2R2M□	2.2µH ±20%	1MHz	2400mA	1800mA	0.116Ω
DFE201612E-4R7M□	4.7µH ±20%	1MHz	1800mA	1200mA	0.252Ω

Absolute maximum voltage: 20V DC

Operating temp. range (Self-temp. rise included): -40 to 125°C

Class of Magnetic Shield: Metal Alloy

Only for reflow soldering

*Isat: Rated Current based on Inductance change

*Itemp: Rated Current based on Temperature rise

Rated current (Isat) is specified when the decrease of the initial inductance value at 30%. Rated current (Itemp) is specified when temperature of the inductor is raised 40°C by DC current.

Inductance-Frequency Characteristics (Typ.)



Inductance-Current Characteristics (Typ.)



Temperature Rise Characteristics (Typ.)



DFE201612P Series 0806 (2016) inch (mm)



Packaging Code	Packaging	Minimum Quantity
=P2	ø180mm Embossed Taping	3000

Part Number (□: packaging code)	Inductance	Inductance Test Frequency	Rated Current (Isat)*	Rated Current (Itemp)*	Max. of DC Resistance
DFE201612P-R24M□	0.24μH ±20%	1MHz	6500mA	4400mA	0.023Ω
DFE201612P-R33M□	0.33μH ±20%	1MHz	5600mA	3900mA	0.028Ω
DFE201612P-R47M□	0.47μH ±20%	1MHz	4800mA	3700mA	0.033Ω
DFE201612P-1R0M□	1.0μH ±20%	1MHz	3300mA	2700mA	0.054Ω
DFE201612P-1R5M□	1.5μH ±20%	1MHz	2700mA	2000mA	0.095Ω
DFE201612P-2R2M□	2.2μH ±20%	1MHz	2100mA	1500mA	0.144Ω

Absolute maximum voltage: 20V DC

Operating temp. range (Self-temp. rise included): -40 to 125°C

Class of Magnetic Shield: Metal Alloy

Only for reflow soldering

*Isat: Rated Current based on Inductance change

*Itemp: Rated Current based on Temperature rise

Rated current (Isat) is specified when the decrease of the initial inductance value at 30%. Rated current (Itemp) is specified when temperature of the inductor is raised 40°C by DC current.

Inductance-Frequency Characteristics (Typ.)



Inductance-Current Characteristics (Typ.)



Temperature Rise Characteristics (Typ.)



DFE201612R Series 0806 (2016) inch (mm)



Packaging Code	Packaging	Minimum Quantity
=P2	ø180mm Embossed Taping	3000

Continued on the following page. ↗

Continued from the preceding page. ↘

Part Number (□: packaging code)	Inductance	Inductance Test Frequency	Rated Current (Isat)*	Rated Current (Itemp)*	Max. of DC Resistance
DFE201612R-H-R47M□	0.47μH ±20%	1MHz	3500mA	3200mA	0.040Ω
DFE201612R-H-1R0M□	1.0μH ±20%	1MHz	2600mA	2600mA	0.070Ω
DFE201612R-H-1R5M□	1.5μH ±20%	1MHz	2100mA	2000mA	0.094Ω
DFE201612R-H-2R2M□	2.2μH ±20%	1MHz	1700mA	1400mA	0.154Ω

Absolute maximum voltage: 20V DC

Operating temp. range (Self-temp. rise included): -40 to 85°C

Class of Magnetic Shield: Metal Alloy

Only for reflow soldering

*Isat: Rated Current based on Inductance change

*Itemp: Rated Current based on Temperature rise

Rated current (Isat) is specified when the decrease of the initial inductance value at 30%. Rated current (Itemp) is specified when temperature of the inductor is raised 40°C by DC current.

Inductance-Frequency Characteristics (Typ.)



Inductance-Current Characteristics (Typ.)



Temperature Rise Characteristics (Typ.)



DFE252007F Series 1008 (2520) inch (mm)



(in mm)

Packaging Code	Packaging	Minimum Quantity
=P2	ø180mm Embossed Taping	3000

Part Number (□: packaging code)	Inductance	Inductance Test Frequency	Rated Current (Isat)*	Rated Current (Itemp)*	Max. of DC Resistance
DFE252007F-R47M□	0.47μH ±20%	1MHz	3300mA	2700mA	0.053Ω
DFE252007F-1R0M□	1.0μH ±20%	1MHz	2800mA	2100mA	0.085Ω
DFE252007F-1R5M□	1.5μH ±20%	1MHz	2100mA	1700mA	0.132Ω
DFE252007F-2R2M□	2.2μH ±20%	1MHz	1800mA	1400mA	0.182Ω
DFE252007F-3R3M□	3.3μH ±20%	1MHz	1500mA	1200mA	0.275Ω
DFE252007F-4R7M□	4.7μH ±20%	1MHz	1200mA	940mA	0.450Ω

Absolute maximum voltage: 20V DC

Operating temp. range (Self-temp. rise included): -40 to 125°C

Class of Magnetic Shield: Metal Alloy

Only for reflow soldering

*Isat: Rated Current based on Inductance change

*Itemp: Rated Current based on Temperature rise

Rated current (Isat) is specified when the decrease of the initial inductance value at 30%. Rated current (Itemp) is specified when temperature of the inductor is raised 40°C by DC current.

Continued on the following page. ↗

Continued from the preceding page. ↘

Inductance-Frequency Characteristics (Typ.)



Inductance-Current Characteristics (Typ.)



Temperature Rise Characteristics (Typ.)



DFE252008C Series 1008 (2520) inch (mm)



Packaging Code	Packaging	Minimum Quantity
=P2	ø180mm Embossed Taping	3000

Part Number (□: packaging code)	Inductance	Inductance Test Frequency	Rated Current (Isat)*	Rated Current (Itemp)*	Max. of DC Resistance
DFE252008C-R47M□	0.47µH ±20%	1MHz	3000mA	2000mA	0.060Ω
DFE252008C-1R0M□	1.0µH ±20%	1MHz	2300mA	1400mA	0.084Ω
DFE252008C-1R5M□	1.5µH ±20%	1MHz	2000mA	1200mA	0.126Ω
DFE252008C-2R2M□	2.2µH ±20%	1MHz	1600mA	950mA	0.180Ω
DFE252008C-3R3M□	3.3µH ±20%	1MHz	1300mA	850mA	0.252Ω
DFE252008C-4R7M□	4.7µH ±20%	1MHz	1100mA	650mA	0.438Ω

Absolute maximum voltage: 20V DC
 Operating temp. range (Self-temp. rise included): -40 to 85°C
 Class of Magnetic Shield: Metal Alloy
 Only for reflow soldering
 *Isat: Rated Current based on Inductance change
 *Itemp: Rated Current based on Temperature rise
 Rated current (Isat) is specified when the decrease of the initial inductance value at 30%. Rated current (Itemp) is specified when temperature of the inductor is raised 40°C by DC current.

Inductance-Frequency Characteristics (Typ.)



Inductance-Current Characteristics (Typ.)



Temperature Rise Characteristics (Typ.)



DFE252008C

Inductors for Power Lines

Inductors for General Circuits

RF Inductors

DFE252008U Series 1008 (2520) inch (mm)



Packaging Code	Packaging	Minimum Quantity
=P2	ø180mm Embossed Taping	3000

Part Number (□: packaging code)	Inductance	Inductance Test Frequency	Rated Current (Isat)*	Rated Current (Itemp)*	Max. of DC Resistance
DFE252008U-R47M□	0.47μH ±20%	1MHz	4500mA	3000mA	0.038Ω
DFE252008U-1R0M□	1.0μH ±20%	1MHz	3500mA	2300mA	0.070Ω
DFE252008U-1R5M□	1.5μH ±20%	1MHz	2700mA	1900mA	0.103Ω
DFE252008U-2R2M□	2.2μH ±20%	1MHz	2300mA	1500mA	0.150Ω
DFE252008U-4R7M□	4.7μH ±20%	1MHz	1600mA	1000mA	0.340Ω
DFE252008U-100M□	10μH ±20%	1MHz	1000mA	600mA	0.880Ω

Absolute maximum voltage: 20V DC
 Operating temp. range (Self-temp. rise included): -40 to 85°C
 Class of Magnetic Shield: Metal Alloy
 Only for reflow soldering
 *Isat: Rated Current based on Inductance change
 *Itemp: Rated Current based on Temperature rise
 Rated current (Isat) is specified when the decrease of the initial inductance value at 30%. Rated current (Itemp) is specified when temperature of the inductor is raised 40°C by DC current.

Inductance-Frequency Characteristics (Typ.)



Inductance-Current Characteristics (Typ.)



Temperature Rise Characteristics (Typ.)



DFE252010C Series 1008 (2520) inch (mm)



Packaging Code	Packaging	Minimum Quantity
=P2	ø180mm Embossed Taping	3000

Continued on the following page. ↗

Continued from the preceding page. ↘

Part Number (□: packaging code)	Inductance	Inductance Test Frequency	Rated Current (Isat)*	Rated Current (Itemp)*	Max. of DC Resistance
1269AS-H-R47M□	0.47μH ±20%	1MHz	3500mA	3100mA	0.046Ω
1269AS-H-1R0M□	1.0μH ±20%	1MHz	2700mA	2500mA	0.078Ω
1269AS-H-1R5M□	1.5μH ±20%	1MHz	2100mA	1900mA	0.108Ω
1269AS-H-2R2M□	2.2μH ±20%	1MHz	1900mA	1500mA	0.156Ω
1269AS-H-3R3M□	3.3μH ±20%	1MHz	1500mA	1200mA	0.228Ω
1269AS-H-4R7M□	4.7μH ±20%	1MHz	1300mA	1000mA	0.300Ω
1269AS-H-6R8M□	6.8μH ±20%	1MHz	1100mA	760mA	0.516Ω
1269AS-H-100N□	10μH ±30%	1MHz	1000mA	680mA	0.689Ω

Absolute maximum voltage: 20V DC

Operating temp. range (Self-temp. rise included): -40 to 85°C

Class of Magnetic Shield: Metal Alloy

Only for reflow soldering

*Isat: Rated Current based on Inductance change

*Itemp: Rated Current based on Temperature rise

Rated current (Isat) is specified when the decrease of the initial inductance value at 30%. Rated current (Itemp) is specified when temperature of the inductor is raised 40°C by DC current.

Inductance-Frequency Characteristics (Typ.)



Inductance-Current Characteristics (Typ.)



Temperature Rise Characteristics (Typ.)



DFE252010F Series 1008 (2520) inch (mm)



(in mm)

Packaging Code	Packaging	Minimum Quantity
=P2	ø180mm Embossed Taping	3000

Part Number (□: packaging code)	Inductance	Inductance Test Frequency	Rated Current (Isat)*	Rated Current (Itemp)*	Max. of DC Resistance
DFE252010F-R33M□	0.33μH ±20%	1MHz	6800mA	4800mA	0.021Ω
DFE252010F-R47M□	0.47μH ±20%	1MHz	6000mA	4400mA	0.027Ω
DFE252010F-R68M□	0.68μH ±20%	1MHz	5000mA	3500mA	0.037Ω
DFE252010F-R82M□	0.82μH ±20%	1MHz	4500mA	3300mA	0.040Ω
DFE252010F-1R0M□	1.0μH ±20%	1MHz	4100mA	3100mA	0.048Ω
DFE252010F-1R5M□	1.5μH ±20%	1MHz	3400mA	2500mA	0.072Ω
DFE252010F-2R2M□	2.2μH ±20%	1MHz	3100mA	2300mA	0.097Ω
DFE252010F-3R3M□	3.3μH ±20%	1MHz	2200mA	1600mA	0.170Ω

Absolute maximum voltage: 20V DC

Operating temp. range (Self-temp. rise included): -40 to 125°C

Class of Magnetic Shield: Metal Alloy

Only for reflow soldering

*Isat: Rated Current based on Inductance change

*Itemp: Rated Current based on Temperature rise

Rated current (Isat) is specified when the decrease of the initial inductance value at 30%. Rated current (Itemp) is specified when temperature of the inductor is raised 40°C by DC current.

Continued on the following page. ↗

Continued from the preceding page. ↘

Part Number (□: packaging code)	Inductance	Inductance Test Frequency	Rated Current (Isat)*	Rated Current (Itemp)*	Max. of DC Resistance
DFE252010F-4R7M□	4.7μH ±20%	1MHz	1900mA	1400mA	0.240Ω
DFE252010F-6R8M□	6.8μH ±20%	1MHz	1400mA	1100mA	0.420Ω
DFE252010F-8R2M□	8.2μH ±20%	1MHz	1350mA	1000mA	0.520Ω
DFE252010F-100M□	10μH ±20%	1MHz	1300mA	900mA	0.600Ω

Absolute maximum voltage: 20V DC

Operating temp. range (Self-temp. rise included): -40 to 125°C

Class of Magnetic Shield: Metal Alloy

Only for reflow soldering

*Isat: Rated Current based on Inductance change

*Itemp: Rated Current based on Temperature rise

Rated current (Isat) is specified when the decrease of the initial inductance value at 30%. Rated current (Itemp) is specified when temperature of the inductor is raised 40°C by DC current.

Inductance-Frequency Characteristics (Typ.)



Inductance-Current Characteristics (Typ.)



Temperature Rise Characteristics (Typ.)



DFE252010P Series 1008 (2520) inch (mm)



(in mm)

Packaging Code	Packaging	Minimum Quantity
=P2	ø180mm Embossed Taping	3000

Part Number (□: packaging code)	Inductance	Inductance Test Frequency	Rated Current (Isat)*	Rated Current (Itemp)*	Max. of DC Resistance
DFE252010P-R33M□	0.33μH ±20%	1MHz	5700mA	3800mA	0.029Ω
DFE252010P-R47M□	0.47μH ±20%	1MHz	5000mA	3500mA	0.035Ω
DFE252010P-R68M□	0.68μH ±20%	1MHz	4100mA	3000mA	0.048Ω
DFE252010P-1R0M□	1.0μH ±20%	1MHz	3800mA	2700mA	0.054Ω
DFE252010P-1R2M□	1.2μH ±20%	1MHz	3200mA	2400mA	0.068Ω
DFE252010P-1R5M□	1.5μH ±20%	1MHz	3000mA	2100mA	0.082Ω
DFE252010P-2R2M□	2.2μH ±20%	1MHz	2600mA	1700mA	0.115Ω
DFE252010P-3R3M□	3.3μH ±20%	1MHz	2100mA	1400mA	0.195Ω
DFE252010P-4R7M□	4.7μH ±20%	1MHz	1700mA	1100mA	0.270Ω

Absolute maximum voltage: 20V DC

Operating temp. range (Self-temp. rise included): -40 to 125°C

Class of Magnetic Shield: Metal Alloy

Only for reflow soldering

*Isat: Rated Current based on Inductance change

*Itemp: Rated Current based on Temperature rise

Rated current (Isat) is specified when the decrease of the initial inductance value at 30%. Rated current (Itemp) is specified when temperature of the inductor is raised 40°C by DC current.

Continued on the following page. ↗

Continued from the preceding page. ↘

Inductance-Frequency Characteristics (Typ.)



Inductance-Current Characteristics (Typ.)



Temperature Rise Characteristics (Typ.)



DFE252010R Series 1008 (2520) inch (mm)



(in mm)

Packaging Code	Packaging	Minimum Quantity
=P2	ø180mm Embossed Taping	3000

Part Number (□: packaging code)	Inductance	Inductance Test Frequency	Rated Current (Isat)*	Rated Current (Itemp)*	Max. of DC Resistance
DFE252010R-H-1R0M□	1.0µH ±20%	1MHz	3000mA	2700mA	0.068Ω
DFE252010R-H-1R5M□	1.5µH ±20%	1MHz	2300mA	2100mA	0.090Ω
DFE252010R-H-2R2M□	2.2µH ±20%	1MHz	2100mA	1700mA	0.126Ω
DFE252010R-H-4R7M□	4.7µH ±20%	1MHz	1400mA	1100mA	0.276Ω

Absolute maximum voltage: 20V DC

Operating temp. range (Self-temp. rise included): -40 to 85°C

Class of Magnetic Shield: Metal Alloy

Only for reflow soldering

*Isat: Rated Current based on Inductance change

*Itemp: Rated Current based on Temperature rise

Rated current (Isat) is specified when the decrease of the initial inductance value at 30%. Rated current (Itemp) is specified when temperature of the inductor is raised 40°C by DC current.

Inductance-Frequency Characteristics (Typ.)



Inductance-Current Characteristics (Typ.)



Temperature Rise Characteristics (Typ.)



DFE252012C Series 1008 (2520) inch (mm)



Packaging Code	Packaging	Minimum Quantity
=P2	ø180mm Embossed Taping	3000

Part Number (□: packaging code)	Inductance	Inductance Test Frequency	Rated Current (Isat)*	Rated Current (Itemp)*	Max. of DC Resistance
1239AS-H-R47M□	0.47μH ±20%	1MHz	3800mA	3700mA	0.039Ω
1239AS-H-1R0M□	1.0μH ±20%	1MHz	3000mA	3000mA	0.059Ω
1239AS-H-1R5M□	1.5μH ±20%	1MHz	2600mA	2400mA	0.072Ω
1239AS-H-2R2M□	2.2μH ±20%	1MHz	2200mA	2000mA	0.108Ω
1239AS-H-3R3M□	3.3μH ±20%	1MHz	1800mA	1500mA	0.144Ω
1239AS-H-4R7M□	4.7μH ±20%	1MHz	1500mA	1300mA	0.240Ω
1239AS-H-6R0M□	6.0μH ±20%	1MHz	1400mA	1100mA	0.275Ω
1239AS-H-6R8M□	6.8μH ±20%	1MHz	1300mA	1000mA	0.375Ω
1239AS-H-100M□	10μH ±20%	1MHz	1000mA	850mA	0.460Ω

Absolute maximum voltage: 20V DC

Operating temp. range (Self-temp. rise included): -40 to 85°C

Class of Magnetic Shield: Metal Alloy

Only for reflow soldering

*Isat: Rated Current based on Inductance change

*Itemp: Rated Current based on Temperature rise

Rated current (Isat) is specified when the decrease of the initial inductance value at 30%. Rated current (Itemp) is specified when temperature of the inductor is raised 40°C by DC current.

Inductance-Frequency Characteristics (Typ.)



Inductance-Current Characteristics (Typ.)



Temperature Rise Characteristics (Typ.)



DFE252012F Series 1008 (2520) inch (mm)



Packaging Code	Packaging	Minimum Quantity
=P2	ø180mm Embossed Taping	3000

Continued on the following page. ↗

Continued from the preceding page. ↘

Part Number (□: packaging code)	Inductance	Inductance Test Frequency	Rated Current (Isat)*	Rated Current (Itemp)*	Max. of DC Resistance
DFE252012F-R33M□	0.33μH ±20%	1MHz	7600mA	5100mA	0.019Ω
DFE252012F-R47M□	0.47μH ±20%	1MHz	6700mA	4900mA	0.023Ω
DFE252012F-R68M□	0.68μH ±20%	1MHz	5400mA	3900mA	0.031Ω
DFE252012F-R82M□	0.82μH ±20%	1MHz	4900mA	3600mA	0.035Ω
DFE252012F-1R0M□	1.0μH ±20%	1MHz	4700mA	3300mA	0.040Ω
DFE252012F-1R5M□	1.5μH ±20%	1MHz	3800mA	2700mA	0.058Ω
DFE252012F-2R2M□	2.2μH ±20%	1MHz	3300mA	2300mA	0.082Ω
DFE252012F-3R3M□	3.3μH ±20%	1MHz	2500mA	1800mA	0.135Ω
DFE252012F-4R7M□	4.7μH ±20%	1MHz	2100mA	1500mA	0.190Ω
DFE252012F-6R8M□	6.8μH ±20%	1MHz	1700mA	1200mA	0.330Ω
DFE252012F-8R2M□	8.2μH ±20%	1MHz	1500mA	1100mA	0.410Ω
DFE252012F-100M□	10μH ±20%	1MHz	1400mA	950mA	0.480Ω

Absolute maximum voltage: 20V DC

Operating temp. range (Self-temp. rise included): -40 to 125°C

Class of Magnetic Shield: Metal Alloy

Only for reflow soldering

*Isat: Rated Current based on Inductance change

*Itemp: Rated Current based on Temperature rise

Rated current (Isat) is specified when the decrease of the initial inductance value at 30%. Rated current (Itemp) is specified when temperature of the inductor is raised 40°C by DC current.

Inductance-Frequency Characteristics (Typ.)



Inductance-Current Characteristics (Typ.)



Temperature Rise Characteristics (Typ.)

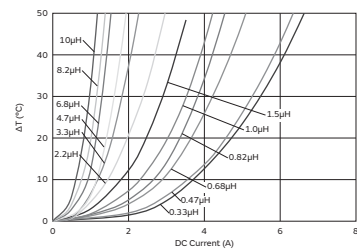

DFE252012P Series 1008 (2520) inch (mm)



(in mm)

Packaging Code	Packaging	Minimum Quantity
=P2	ø180mm Embossed Taping	3000

Part Number (□: packaging code)	Inductance	Inductance Test Frequency	Rated Current (Isat)*	Rated Current (Itemp)*	Max. of DC Resistance
DFE252012P-R33M□	0.33μH ±20%	1MHz	6600mA	4600mA	0.023Ω
DFE252012P-R47M□	0.47μH ±20%	1MHz	5700mA	4000mA	0.027Ω
DFE252012P-R68M□	0.68μH ±20%	1MHz	4800mA	3500mA	0.037Ω
DFE252012P-1R0M□	1.0μH ±20%	1MHz	4300mA	3200mA	0.042Ω

Absolute maximum voltage: 20V DC

Operating temp. range (Self-temp. rise included): -40 to 125°C

Class of Magnetic Shield: Metal Alloy

Only for reflow soldering

*Isat: Rated Current based on Inductance change

*Itemp: Rated Current based on Temperature rise

Rated current (Isat) is specified when the decrease of the initial inductance value at 30%. Rated current (Itemp) is specified when temperature of the inductor is raised 40°C by DC current.

Continued on the following page. ↗

Continued from the preceding page. ↘

Part Number (□: packaging code)	Inductance	Inductance Test Frequency	Rated Current (Isat)*	Rated Current (Itemp)*	Max. of DC Resistance
DFE252012P-1R5M□	1.5μH ±20%	1MHz	3500mA	2600mA	0.060Ω
DFE252012P-2R2M□	2.2μH ±20%	1MHz	3000mA	2200mA	0.084Ω
DFE252012P-3R3M□	3.3μH ±20%	1MHz	2300mA	1700mA	0.140Ω
DFE252012P-4R7M□	4.7μH ±20%	1MHz	2000mA	1400mA	0.200Ω

Absolute maximum voltage: 20V DC

Operating temp. range (Self-temp. rise included): -40 to 125°C

Class of Magnetic Shield: Metal Alloy

Only for reflow soldering

*Isat: Rated Current based on Inductance change

*Itemp: Rated Current based on Temperature rise

Rated current (Isat) is specified when the decrease of the initial inductance value at 30%. Rated current (Itemp) is specified when temperature of the inductor is raised 40°C by DC current.

Inductance-Frequency Characteristics (Typ.)



Inductance-Current Characteristics (Typ.)



Temperature Rise Characteristics (Typ.)



DFE252012R Series 1008 (2520) inch (mm)



(in mm)

Packaging Code	Packaging	Minimum Quantity
=P2	ø180mm Embossed Taping	3000

Part Number (□: packaging code)	Inductance	Inductance Test Frequency	Rated Current (Isat)*	Rated Current (Itemp)*	Max. of DC Resistance
DFE252012R-H-1R0M□	1.0μH ±20%	1MHz	3400mA	3100mA	0.049Ω
DFE252012R-H-1R5M□	1.5μH ±20%	1MHz	2800mA	2500mA	0.065Ω
DFE252012R-H-2R2M□	2.2μH ±20%	1MHz	2400mA	2000mA	0.090Ω
DFE252012R-H-4R7M□	4.7μH ±20%	1MHz	1700mA	1400mA	0.216Ω

Absolute maximum voltage: 20V DC

Operating temp. range (Self-temp. rise included): -40 to 85°C

Class of Magnetic Shield: Metal Alloy

Only for reflow soldering

*Isat: Rated Current based on Inductance change

*Itemp: Rated Current based on Temperature rise

Rated current (Isat) is specified when the decrease of the initial inductance value at 30%. Rated current (Itemp) is specified when temperature of the inductor is raised 40°C by DC current.

Continued on the following page. ↗

Inductors for Power Lines
 DFE252012R
 Inductors for General Circuits
 RF Inductors

Continued from the preceding page. ↘

Inductance-Frequency Characteristics (Typ.)



Inductance-Current Characteristics (Typ.)

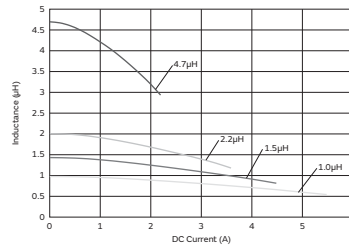

Temperature Rise Characteristics (Typ.)



DFE322510C Series 1210 (3225) inch (mm)



Packaging Code	Packaging	Minimum Quantity
=P2	ø180mm Embossed Taping	3000

Part Number (□: packaging code)	Inductance	Inductance Test Frequency	Rated Current (Isat)*	Rated Current (Itemp)*	Max. of DC Resistance
1276AS-H-R47M□	0.47µH ±20%	1MHz	3800mA	3300mA	0.038Ω
1276AS-H-R68M□	0.68µH ±20%	1MHz	3500mA	2900mA	0.045Ω
1276AS-H-1R0M□	1.0µH ±20%	1MHz	3100mA	2600mA	0.062Ω
1276AS-H-1R5M□	1.5µH ±20%	1MHz	2600mA	2100mA	0.087Ω
1276AS-H-2R2M□	2.2µH ±20%	1MHz	2200mA	1600mA	0.118Ω
1276AS-H-3R3M□	3.3µH ±20%	1MHz	1800mA	1400mA	0.190Ω
1276AS-H-4R7M□	4.7µH ±20%	1MHz	1600mA	1200mA	0.264Ω
1276AS-H-6R8M□	6.8µH ±20%	1MHz	1300mA	1000mA	0.378Ω
1276AS-H-100M□	10µH ±20%	1MHz	1000mA	800mA	0.588Ω

Absolute maximum voltage: 20V DC

Operating temp. range (Self-temp. rise included): -40 to 85°C

Class of Magnetic Shield: Metal Alloy

Only for reflow soldering

*Isat: Rated Current based on Inductance change

*Itemp: Rated Current based on Temperature rise

Rated current (Isat) is specified when the decrease of the initial inductance value at 30%. Rated current (Itemp) is specified when temperature of the inductor is raised 40°C by DC current.

Inductance-Frequency Characteristics (Typ.)

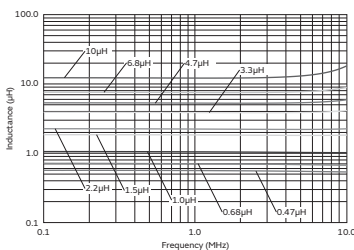

Inductance-Current Characteristics (Typ.)

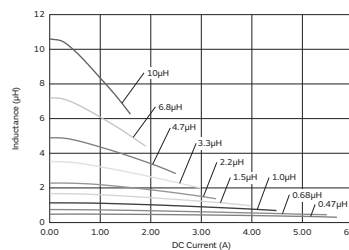

Temperature Rise Characteristics (Typ.)

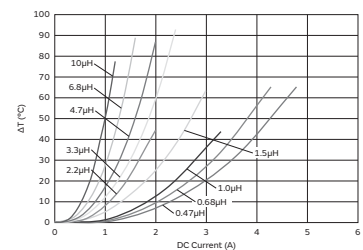

DFE322512C Series 1210 (3225) inch (mm)



Packaging Code	Packaging	Minimum Quantity
=P2	ø180mm Embossed Taping	3000

Part Number (□: packaging code)	Inductance	Inductance Test Frequency	Rated Current (Isat)*	Rated Current (Itemp)*	Max. of DC Resistance
1277AS-H-R47M□	0.47μH ±20%	1MHz	4700mA	3700mA	0.031Ω
1277AS-H-R68M□	0.68μH ±20%	1MHz	4200mA	3500mA	0.035Ω
1277AS-H-1R0M□	1.0μH ±20%	1MHz	3700mA	3100mA	0.045Ω
1277AS-H-1R5M□	1.5μH ±20%	1MHz	3000mA	2600mA	0.065Ω
1277AS-H-2R2M□	2.2μH ±20%	1MHz	2600mA	2100mA	0.084Ω
1277AS-H-3R3M□	3.3μH ±20%	1MHz	2100mA	1800mA	0.126Ω
1277AS-H-4R7M□	4.7μH ±20%	1MHz	1800mA	1400mA	0.180Ω
1277AS-H-6R8M□	6.8μH ±20%	1MHz	1500mA	1200mA	0.276Ω
1277AS-H-100M□	10μH ±20%	1MHz	1200mA	900mA	0.420Ω

Absolute maximum voltage: 20V DC

Operating temp. range (Self-temp. rise included): -40 to 85°C

Class of Magnetic Shield: Metal Alloy

Only for reflow soldering

*Isat: Rated Current based on Inductance change

*Itemp: Rated Current based on Temperature rise

Rated current (Isat) is specified when the decrease of the initial inductance value at 30%. Rated current (Itemp) is specified when temperature of the inductor is raised 40°C by DC current.

Inductance-Frequency Characteristics (Typ.)



Inductance-Current Characteristics (Typ.)



Temperature Rise Characteristics (Typ.)



DFE322512F Series 1210 (3225) inch (mm)



Packaging Code	Packaging	Minimum Quantity
=P2	ø180mm Embossed Taping	3000

Continued on the following page. ↗

Continued from the preceding page. ↘

Part Number (□: packaging code)	Inductance	Inductance Test Frequency	Rated Current (Isat)*	Rated Current (Itemp)*	Max. of DC Resistance
DFE322512F-R47M□	0.47μH ±20%	1MHz	6700mA	4800mA	0.023Ω
DFE322512F-R68M□	0.68μH ±20%	1MHz	6100mA	4400mA	0.026Ω
DFE322512F-1R0M□	1.0μH ±20%	1MHz	4800mA	3800mA	0.032Ω
DFE322512F-1R5M□	1.5μH ±20%	1MHz	3900mA	3000mA	0.048Ω
DFE322512F-2R2M□	2.2μH ±20%	1MHz	3400mA	2600mA	0.066Ω
DFE322512F-3R3M□	3.3μH ±20%	1MHz	2600mA	2000mA	0.108Ω
DFE322512F-4R7M□	4.7μH ±20%	1MHz	2300mA	1600mA	0.157Ω
DFE322512F-6R8M□	6.8μH ±20%	1MHz	2000mA	1200mA	0.220Ω
DFE322512F-100M□	10μH ±20%	1MHz	1700mA	1100mA	0.324Ω

Absolute maximum voltage: 20V DC

Operating temp. range (Self-temp. rise included): -40 to 125°C

Class of Magnetic Shield: Metal Alloy

Only for reflow soldering

*Isat: Rated Current based on Inductance change

*Itemp: Rated Current based on Temperature rise

Rated current (Isat) is specified when the decrease of the initial inductance value at 30%. Rated current (Itemp) is specified when temperature of the inductor is raised 40°C by DC current.

Inductance-Frequency Characteristics (Typ.)



Inductance-Current Characteristics (Typ.)



Temperature Rise Characteristics (Typ.)



FDSD0412 Series 1515 (4040) inch (mm)



Packaging Code	Packaging	Minimum Quantity
=P3	ø330mm Embossed Taping	4000

Part Number (□: packaging code)	Inductance	Inductance Test Frequency	Rated Current (Isat)*	Rated Current (Itemp)*	Max. of DC Resistance
FDSD0412-H-R33M□	0.33μH ±20%	0.1MHz	7500mA	6400mA	0.019Ω
FDSD0412-H-R47M□	0.47μH ±20%	0.1MHz	6500mA	6000mA	0.023Ω
FDSD0412-H-1R0M□	1.0μH ±20%	0.1MHz	4700mA	4300mA	0.044Ω
FDSD0412-H-1R2M□	1.2μH ±20%	0.1MHz	4500mA	3700mA	0.048Ω
FDSD0412-H-1R5M□	1.5μH ±20%	0.1MHz	4100mA	3300mA	0.064Ω
FDSD0412-H-2R2M□	2.2μH ±20%	0.1MHz	3500mA	2800mA	0.084Ω
FDSD0412-H-3R3M□	3.3μH ±20%	0.1MHz	2800mA	2200mA	0.122Ω

Absolute maximum voltage: 30V DC

Operating temp. range (Self-temp. rise included): -40 to 125°C

Class of Magnetic Shield: Metal Alloy

Only for reflow soldering

*Isat: Rated Current based on Inductance change

*Itemp: Rated Current based on Temperature rise

Rated current (Isat) is specified when the decrease of the initial inductance value at 30%. Rated current (Itemp) is specified when temperature of the inductor is raised 40°C by DC current.

Continued on the following page. ↗

Continued from the preceding page. ↘

Part Number (□: packaging code)	Inductance	Inductance Test Frequency	Rated Current (Isat)*	Rated Current (Itemp)*	Max. of DC Resistance
FDSD0412-H-4R7M □	4.7μH ±20%	0.1MHz	2500mA	1900mA	0.161Ω

Absolute maximum voltage: 30V DC

Operating temp. range (Self-temp. rise included): -40 to 125°C

Class of Magnetic Shield: Metal Alloy

Only for reflow soldering

*Isat: Rated Current based on Inductance change

*Itemp: Rated Current based on Temperature rise

Rated current (Isat) is specified when the decrease of the initial inductance value at 30%. Rated current (Itemp) is specified when temperature of the inductor is raised 40°C by DC current.

Inductance-Frequency Characteristics (Typ.)



Inductance-Current Characteristics (Typ.)



Temperature Rise Characteristics (Typ.)



FDSD0415 Series 1515 (4040) inch (mm)



Packaging Code	Packaging	Minimum Quantity
=P3	ø330mm Embossed Taping	4000

Part Number (□: packaging code)	Inductance	Inductance Test Frequency	Rated Current (Isat)*	Rated Current (Itemp)*	Max. of DC Resistance
FDSD0415-H-R22M □	0.22μH ±20%	0.1MHz	12000mA	7700mA	0.014Ω
FDSD0415-H-R47M □	0.47μH ±20%	0.1MHz	9000mA	6100mA	0.018Ω
FDSD0415-H-1R0M □	1.0μH ±20%	0.1MHz	5300mA	4500mA	0.041Ω
FDSD0415-H-1R5M □	1.5μH ±20%	0.1MHz	5000mA	3700mA	0.047Ω
FDSD0415-H-2R2M □	2.2μH ±20%	0.1MHz	4100mA	3100mA	0.065Ω
FDSD0415-H-3R3M □	3.3μH ±20%	0.1MHz	3400mA	2600mA	0.095Ω
FDSD0415-H-4R7M □	4.7μH ±20%	0.1MHz	2900mA	2100mA	0.120Ω

Absolute maximum voltage: 30V DC

Operating temp. range (Self-temp. rise included): -40 to 125°C

Class of Magnetic Shield: Metal Alloy

Only for reflow soldering

*Isat: Rated Current based on Inductance change

*Itemp: Rated Current based on Temperature rise

Rated current (Isat) is specified when the decrease of the initial inductance value at 30%. Rated current (Itemp) is specified when temperature of the inductor is raised 40°C by DC current.

Continued on the following page. ↗

Inductors for Power Lines
FDSD0415

Inductors for General Circuits

RF Inductors

Continued from the preceding page. ↘

Inductance-Frequency Characteristics (Typ.)

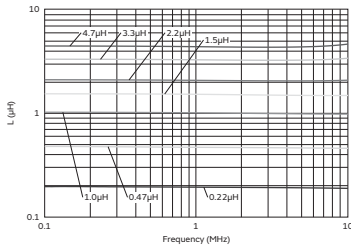

Inductance-Current Characteristics (Typ.)

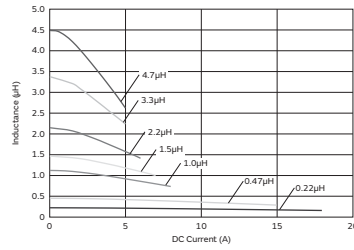

Temperature Rise Characteristics (Typ.)



FDSD0420 Series 1515 (4040) inch (mm)



Packaging Code	Packaging	Minimum Quantity
=P3	ø330mm Embossed Taping	2000

Part Number (□: packaging code)	Inductance	Inductance Test Frequency	Rated Current (Isat)*	Rated Current (Itemp)*	Max. of DC Resistance
FDSD0420-H-R33M□	0.33µH ±20%	0.1MHz	11000mA	7700mA	0.014Ω
FDSD0420-H-R47M□	0.47µH ±20%	0.1MHz	9400mA	6800mA	0.018Ω
FDSD0420-H-R68M□	0.68µH ±20%	0.1MHz	8300mA	6500mA	0.022Ω
FDSD0420-H-1R0M□	1.0µH ±20%	0.1MHz	6800mA	5100mA	0.029Ω
FDSD0420-H-1R5M□	1.5µH ±20%	0.1MHz	5700mA	4300mA	0.036Ω
FDSD0420-H-2R2M□	2.2µH ±20%	0.1MHz	4100mA	3600mA	0.047Ω
FDSD0420-H-3R3M□	3.3µH ±20%	0.1MHz	3700mA	2900mA	0.071Ω
FDSD0420-H-4R7M□	4.7µH ±20%	0.1MHz	3600mA	2700mA	0.083Ω
FDSD0420-H-6R8M□	6.8µH ±20%	0.1MHz	2700mA	1900mA	0.150Ω
FDSD0420-H-100M□	10µH ±20%	0.1MHz	2500mA	1700mA	0.200Ω

Absolute maximum voltage: 30V DC

Operating temp. range (Self-temp. rise included): -40 to 125°C

Class of Magnetic Shield: Metal Alloy

Only for reflow soldering

*Isat: Rated Current based on Inductance change

*Itemp: Rated Current based on Temperature rise

Rated current (Isat) is specified when the decrease of the initial inductance value at 30%. Rated current (Itemp) is specified when temperature of the inductor is raised 40°C by DC current.

Inductance-Frequency Characteristics (Typ.)

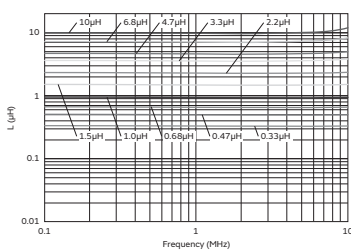

Inductance-Current Characteristics (Typ.)

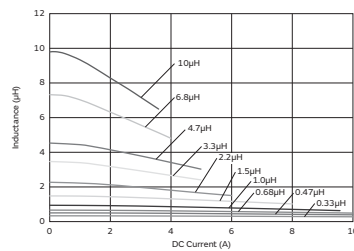

Temperature Rise Characteristics (Typ.)



FDSD0420

Inductors for Power Lines

Inductors for General Circuits

RF Inductors

FDSD0420W Series 1515 (4040) inch (mm)



Packaging Code	Packaging	Minimum Quantity
=P3	ø330mm Embossed Taping	2000

Part Number (□: packaging code)	Inductance	Inductance Test Frequency	Rated Current (Isat)*	Rated Current (Itemp)*	Max. of DC Resistance
FDSD0420W-H-150M□	15μH ±20%	0.1MHz	1900mA	1100mA	0.35Ω
FDSD0420W-H-220M□	22μH ±20%	0.1MHz	1500mA	820mA	0.54Ω

Absolute maximum voltage: 30V DC

Operating temp. range (Self-temp. rise included): -40 to 125°C

Class of Magnetic Shield: Metal Alloy

Only for reflow soldering

*Isat: Rated Current based on Inductance change

*Itemp: Rated Current based on Temperature rise

Rated current (Isat) is specified when the decrease of the initial inductance value at 30%. Rated current (Itemp) is specified when temperature of the inductor is raised 40°C by DC current.

Inductance-Current Characteristics (Typ.)



Temperature Rise Characteristics (Typ.)



FDSD0512 Series 2019 (5249) inch (mm)



Packaging Code	Packaging	Minimum Quantity
=P3	ø330mm Embossed Taping	4000

Continued on the following page. ↗

Continued from the preceding page. ↘

Part Number (□: packaging code)	Inductance	Inductance Test Frequency	Rated Current (Isat)*	Rated Current (Itemp)*	Max. of DC Resistance
FDSD0512-H-1R0M □	1.0μH ±20%	0.1MHz	6100mA	4000mA	0.044Ω
FDSD0512-H-K2R2M □	2.2μH ±20%	0.1MHz	4200mA	3200mA	0.068Ω
FDSD0512-H-4R7M □	4.7μH ±20%	0.1MHz	3000mA	2000mA	0.180Ω
FDSD0512-H-6R8M □	6.8μH ±20%	0.1MHz	2300mA	1700mA	0.210Ω

Absolute maximum voltage: 30V DC

Operating temp. range (Self-temp. rise included): -40 to 125°C

Class of Magnetic Shield: Metal Alloy

Only for reflow soldering

*Isat: Rated Current based on Inductance change

*Itemp: Rated Current based on Temperature rise

Rated current (Isat) is specified when the decrease of the initial inductance value at 30%. Rated current (Itemp) is specified when temperature of the inductor is raised 40°C by DC current.

Inductance-Frequency Characteristics (Typ.)



Inductance-Current Characteristics (Typ.)



Temperature Rise Characteristics (Typ.)



FDSD0515 Series 2019 (5249) inch (mm)



Packaging Code	Packaging	Minimum Quantity
=P3	ø330mm Embossed Taping	4000

Part Number (□: packaging code)	Inductance	Inductance Test Frequency	Rated Current (Isat)*	Rated Current (Itemp)*	Max. of DC Resistance
FDSD0515-H-1R0M □	1.0μH ±20%	0.1MHz	7000mA	5200mA	0.030Ω
FDSD0515-H-2R2M □	2.2μH ±20%	0.1MHz	4800mA	3400mA	0.059Ω
FDSD0515-H-3R3M □	3.3μH ±20%	0.1MHz	3800mA	3000mA	0.075Ω
FDSD0515-H-4R7M □	4.7μH ±20%	0.1MHz	3200mA	2600mA	0.100Ω

Absolute maximum voltage: 30V DC

Operating temp. range (Self-temp. rise included): -40 to 125°C

Class of Magnetic Shield: Metal Alloy

Only for reflow soldering

*Isat: Rated Current based on Inductance change

*Itemp: Rated Current based on Temperature rise

Rated current (Isat) is specified when the decrease of the initial inductance value at 30%. Rated current (Itemp) is specified when temperature of the inductor is raised 40°C by DC current.

Continued on the following page. ↗

FDSD0515 Inductors for Power Lines

Inductors for General Circuits

RF Inductors

Continued from the preceding page. ↘

Inductance-Frequency Characteristics (Typ.)



Inductance-Current Characteristics (Typ.)



Temperature Rise Characteristics (Typ.)



FDSD0518 Series 2019 (5249) inch (mm)



Packaging Code	Packaging	Minimum Quantity
=P3	ø330mm Embossed Taping	2000

Part Number (□: packaging code)	Inductance	Inductance Test Frequency	Rated Current (Isat)*	Rated Current (Itemp)*	Max. of DC Resistance
FDSD0518-H-R68M□	0.68µH ±20%	0.1MHz	9000mA	6800mA	0.019Ω
FDSD0518-H-1R0M□	1.0µH ±20%	0.1MHz	8700mA	6100mA	0.021Ω
FDSD0518-H-1R5M□	1.5µH ±20%	0.1MHz	6700mA	5300mA	0.029Ω
FDSD0518-H-2R2M□	2.2µH ±20%	0.1MHz	5400mA	4300mA	0.040Ω
FDSD0518-H-3R3M□	3.3µH ±20%	0.1MHz	4600mA	3400mA	0.058Ω
FDSD0518-H-4R7M□	4.7µH ±20%	0.1MHz	3900mA	3000mA	0.073Ω
FDSD0518-H-6R8M□	6.8µH ±20%	0.1MHz	2900mA	2600mA	0.106Ω
FDSD0518-H-100M□	10µH ±20%	0.1MHz	2700mA	2400mA	0.150Ω

Absolute maximum voltage: 30V DC

Operating temp. range (Self-temp. rise included): -40 to 125°C

Class of Magnetic Shield: Metal Alloy

Only for reflow soldering

*Isat: Rated Current based on Inductance change

*Itemp: Rated Current based on Temperature rise

Rated current (Isat) is specified when the decrease of the initial inductance value at 30%. Rated current (Itemp) is specified when temperature of the inductor is raised 40°C by DC current.

Inductance-Frequency Characteristics (Typ.)



Inductance-Current Characteristics (Typ.)



Temperature Rise Characteristics (Typ.)



FDV0530S Series 2020 (5050) inch (mm)



Packaging Code	Packaging	Minimum Quantity
=P3	ø330mm Embossed Taping	2000

Part Number (□: packaging code)	Inductance	Inductance Test Frequency	Rated Current (I _{sat})*	Rated Current (I _{temp})*	Max. of DC Resistance
FDV0530S-H-R12M□	0.12μH ±20%	0.1MHz	18000mA	13000mA	0.0039Ω
FDV0530S-H-R24M□	0.24μH ±20%	0.1MHz	13000mA	11000mA	0.0056Ω
FDV0530S-H-R42M□	0.42μH ±20%	0.1MHz	9000mA	8200mA	0.0098Ω
FDV0530S-H-R60M□	0.60μH ±20%	0.1MHz	7900mA	7200mA	0.012Ω
FDV0530S-H-R78M□	0.78μH ±20%	0.1MHz	7100mA	6900mA	0.014Ω
FDV0530S-H-1R0M□	1.0μH ±20%	0.1MHz	6200mA	5700mA	0.017Ω
FDV0530S-H-1R5M□	1.5μH ±20%	0.1MHz	5400mA	4900mA	0.024Ω
FDV0530S-H-2R2M□	2.2μH ±20%	0.1MHz	4500mA	4300mA	0.034Ω

Absolute maximum voltage: 30V DC

Operating temp. range (Self-temp. rise included): -40 to 125°C

Class of Magnetic Shield: Metal Alloy

Only for reflow soldering

*I_{sat}: Rated Current based on Inductance change

*I_{temp}: Rated Current based on Temperature rise

Rated current (I_{sat}) is specified when the decrease of the initial inductance value at 30%. Rated current (I_{temp}) is specified when temperature of the inductor is raised 40°C by DC current.

Inductance-Current Characteristics (Typ.)



Temperature Rise Characteristics (Typ.)



FDV0530 Series 2423 (6258) inch (mm)



Packaging Code	Packaging	Minimum Quantity
=P3	ø330mm Embossed Taping	1000

Continued on the following page. ↗

Continued from the preceding page. ↘

Part Number (□: packaging code)	Inductance	Inductance Test Frequency	Rated Current (Isat)*	Rated Current (Itemp)*	Max. of DC Resistance
FDV0530-H-R11M□	0.11μH ±20%	0.1MHz	19600mA	18200mA	0.0016Ω
FDV0530-H-R20M□	0.2μH ±20%	0.1MHz	17500mA	17700mA	0.0024Ω
FDV0530-H-R36M□	0.36μH ±20%	0.1MHz	12600mA	13900mA	0.0041Ω
FDV0530-H-R56M□	0.56μH ±20%	0.1MHz	11300mA	11100mA	0.0063Ω
FDV0530-H-R75M□	0.75μH ±20%	0.1MHz	9900mA	9700mA	0.0076Ω
FDV0530-H-1R0M□	1.0μH ±20%	0.1MHz	8400mA	7700mA	0.0112Ω
FDV0530-H-1R5M□	1.5μH ±20%	0.1MHz	5700mA	6600mA	0.0155Ω
FDV0530-H-2R2M□	2.2μH ±20%	0.1MHz	5300mA	6000mA	0.0199Ω
FDV0530-H-3R3M□	3.3μH ±20%	0.1MHz	4100mA	4500mA	0.0341Ω
FDV0530-H-4R7M□	4.7μH ±20%	0.1MHz	3500mA	3600mA	0.0536Ω

Absolute maximum voltage: 30V DC

Operating temp. range (Self-temp. rise included): -40 to 125°C

Class of Magnetic Shield: Metal Alloy

Only for reflow soldering

*Isat: Rated Current based on Inductance change

*Itemp: Rated Current based on Temperature rise

Rated current (Isat) is specified when the decrease of the initial inductance value at 20%. Rated current (Itemp) is specified when temperature of the inductor is raised 40°C by DC current.

Inductance-Current Characteristics (Typ.)



Temperature Rise Characteristics (Typ.)



FCUL0530 Series 2522 (6357) inch (mm)



Packaging Code	Packaging	Minimum Quantity
=P3	ø330mm Embossed Taping	1000

Part Number (□: packaging code)	Inductance	Inductance Test Frequency	Rated Current (Isat)*	Rated Current (Itemp)*	DC Resistance
FCUL0530-R36M□	0.36μH ±20%	0.1MHz	17000mA	18000mA	0.00240Ω±7%
FCUL0530-R47M□	0.47μH ±20%	0.1MHz	14000mA	16000mA	0.00285Ω±7%

Absolute maximum voltage: 30V DC

Operating temp. range (Self-temp. rise included): -40 to 125°C

Class of Magnetic Shield: Metal Alloy

Only for reflow soldering

*Isat: Rated Current based on Inductance change

*Itemp: Rated Current based on Temperature rise

Rated current (Isat) is specified when the decrease of the initial inductance value at 30%. Rated current (Itemp) is specified when temperature of the inductor is raised 40°C by DC current.

Continued on the following page. ↗

Continued from the preceding page. ↘

Inductance-Frequency Characteristics (Typ.)



Inductance-Current Characteristics (Typ.)



Temperature Rise Characteristics (Typ.)



FDSD0630 Series 2726 (7066) inch (mm)



Packaging Code	Packaging	Minimum Quantity
=P3	ø330mm Embossed Taping	1000

Part Number (□: packaging code)	Inductance	Inductance Test Frequency	Rated Current (Isat)*	Rated Current (Itemp)*	Max. of DC Resistance
FDSD0630-H-R68M□	0.68µH ±20%	0.1MHz	17000mA	9600mA	0.0086Ω
FDSD0630-H-1R0M□	1.0µH ±20%	0.1MHz	15000mA	9400mA	0.0110Ω
FDSD0630-H-1R5N□	1.5µH ±30%	0.1MHz	13000mA	8500mA	0.0130Ω
FDSD0630-H-2R2M□	2.2µH ±20%	0.1MHz	12000mA	7100mA	0.0170Ω
FDSD0630-H-3R3M□	3.3µH ±20%	0.1MHz	8000mA	5600mA	0.0280Ω
FDSD0630-H-4R7M□	4.7µH ±20%	0.1MHz	7600mA	4700mA	0.0400Ω
FDSD0630-H-5R6M□	5.6µH ±20%	0.1MHz	7000mA	4200mA	0.0460Ω
FDSD0630-H-6R8M□	6.8µH ±20%	0.1MHz	5900mA	3700mA	0.0610Ω
FDSD0630-H-8R2M□	8.2µH ±20%	0.1MHz	5500mA	3400mA	0.0700Ω
FDSD0630-H-100M□	10µH ±20%	0.1MHz	5400mA	3200mA	0.0740Ω

Absolute maximum voltage: 30V DC

Operating temp. range (Self-temp. rise included): -40 to 125°C

Class of Magnetic Shield: Metal Alloy

Only for reflow soldering

*Isat: Rated Current based on Inductance change

*Itemp: Rated Current based on Temperature rise

Rated current (Isat) is specified when the decrease of the initial inductance value at 30%. Rated current (Itemp) is specified when temperature of the inductor is raised 40°C by DC current.

Inductance-Frequency Characteristics (Typ.)



Inductance-Current Characteristics (Typ.)



Temperature Rise Characteristics (Typ.)



FCUL0624 Series 2926 (7366) inch (mm)



Packaging Code	Packaging	Minimum Quantity
=P3	ø330mm Embossed Taping	1500

Part Number (□: packaging code)	Inductance	Inductance Test Frequency	Rated Current (Isat)*	Rated Current (Itemp)*	DC Resistance
FCUL0624-H-R22M□	0.22μH ±20%	0.1MHz	23000mA	24000mA	0.00140Ω±7%
FCUL0624-H-R47M□	0.47μH ±20%	0.1MHz	17000mA	16000mA	0.00327Ω±7%

Absolute maximum voltage: 30V DC

Operating temp. range (Self-temp. rise included): -40 to 125°C

Class of Magnetic Shield: Metal Alloy

Only for reflow soldering

*Isat: Rated Current based on Inductance change

*Itemp: Rated Current based on Temperature rise

Rated current (Isat) is specified when the decrease of the initial inductance value at 30%. Rated current (Itemp) is specified when temperature of the inductor is raised 40°C by DC current.

Inductance-Frequency Characteristics (Typ.)



Inductance-Current Characteristics (Typ.)



Temperature Rise Characteristics (Typ.)



FCUL0630 Series 2926 (7366) inch (mm)



Packaging Code	Packaging	Minimum Quantity
=P3	ø330mm Embossed Taping	1000

Continued on the following page. ↗

Continued from the preceding page. ↘

Part Number (□: packaging code)	Inductance	Inductance Test Frequency	Rated Current (Isat)*	Rated Current (Itemp)*	DC Resistance
FCUL0630-H-R12M□	0.12μH ±20%	0.1MHz	30000mA	32000mA	0.00077Ω±7%
FCUL0630-H-R22M□	0.22μH ±20%	0.1MHz	25000mA	26000mA	0.00112Ω±7%
FCUL0630-H-R36M□	0.36μH ±20%	0.1MHz	18000mA	21000mA	0.00190Ω±7%
FCUL0630-H-R47M□	0.47μH ±20%	0.1MHz	18000mA	18000mA	0.00248Ω±7%
FCUL0630-H-R56M□	0.56μH ±20%	0.1MHz	14000mA	17000mA	0.00283Ω±7%
FCUL0630-H-R68M□	0.68μH ±20%	0.1MHz	14000mA	15000mA	0.00358Ω±7%

Absolute maximum voltage: 30V DC

Operating temp. range (Self-temp. rise included): -40 to 125°C

Class of Magnetic Shield: Metal Alloy

Only for reflow soldering

*Isat: Rated Current based on Inductance change

*Itemp: Rated Current based on Temperature rise

Rated current (Isat) is specified when the decrease of the initial inductance value at 30%. Rated current (Itemp) is specified when temperature of the inductor is raised 40°C by DC current.

Inductance-Frequency Characteristics (Typ.)



Inductance-Current Characteristics (Typ.)



Temperature Rise Characteristics (Typ.)



FDV0618 Series 2926 (7467) inch (mm)



Packaging Code	Packaging	Minimum Quantity
=P3	ø330mm Embossed Taping	1500

Part Number (□: packaging code)	Inductance	Inductance Test Frequency	Rated Current (Isat)*	Rated Current (Itemp)*	Max. of DC Resistance
FDV0618-H-R24N□	0.24μH ±30%	0.1MHz	14000mA	13000mA	0.0045Ω
FDV0618-H-R35N□	0.35μH ±30%	0.1MHz	11000mA	10000mA	0.0068Ω
FDV0618-H-R68M□	0.68μH ±20%	0.1MHz	9800mA	8700mA	0.0100Ω
FDV0618-H-1R0M□	1.0μH ±20%	0.1MHz	7100mA	5400mA	0.0170Ω
FDV0618-H-1R5N□	1.5μH ±30%	0.1MHz	6000mA	4800mA	0.0270Ω
FDV0618-H-2R2M□	2.2μH ±20%	0.1MHz	5300mA	4400mA	0.0340Ω
FDV0618-H-3R3M□	3.3μH ±20%	0.1MHz	4100mA	3200mA	0.0480Ω

Absolute maximum voltage: 30V DC

Operating temp. range (Self-temp. rise included): -40 to 125°C

Class of Magnetic Shield: Metal Alloy

Only for reflow soldering

*Isat: Rated Current based on Inductance change

*Itemp: Rated Current based on Temperature rise

Rated current (Isat) is specified when the decrease of the initial inductance value at 30%. Rated current (Itemp) is specified when temperature of the inductor is raised 40°C by DC current.

Continued on the following page. ↗

Continued from the preceding page. ↘

Inductance-Current Characteristics (Typ.)



Temperature Rise Characteristics (Typ.)



FDV0620 Series 2926 (7467) inch (mm)



Packaging Code	Packaging	Minimum Quantity
=P3	ø330mm Embossed Taping	1500

Part Number (□: packaging code)	Inductance	Inductance Test Frequency	Rated Current (Isat)*	Rated Current (Itemp)*	Max. of DC Resistance
FDV0620-H-R20M□	0.2µH ±20%	0.1MHz	16200mA	12400mA	0.0045Ω
FDV0620-H-R47M□	0.47µH ±20%	0.1MHz	11000mA	9000mA	0.0083Ω
FDV0620-H-R68M□	0.68µH ±20%	0.1MHz	10000mA	7700mA	0.0100Ω
FDV0620-H-1R0M□	1.0µH ±20%	0.1MHz	7700mA	5700mA	0.0180Ω
FDV0620-H-1R5M□	1.5µH ±20%	0.1MHz	6000mA	5000mA	0.0260Ω
FDV0620-H-2R2M□	2.2µH ±20%	0.1MHz	5100mA	4000mA	0.0370Ω
FDV0620-H-3R3M□	3.3µH ±20%	0.1MHz	4200mA	3200mA	0.0510Ω
FDV0620-H-4R7M□	4.7µH ±20%	0.1MHz	3500mA	2800mA	0.0680Ω

Absolute maximum voltage: 30V DC

Operating temp. range (Self-temp. rise included): -40 to 125°C

Class of Magnetic Shield: Metal Alloy

Only for reflow soldering

*Isat: Rated Current based on Inductance change

*Itemp: Rated Current based on Temperature rise

Rated current (Isat) is specified when the decrease of the initial inductance value at 20%. Rated current (Itemp) is specified when temperature of the inductor is raised 40°C by DC current.

Inductance-Current Characteristics (Typ.)



Temperature Rise Characteristics (Typ.)



FDVE0630 Series 2926 (7467) inch (mm)



Packaging Code	Packaging	Minimum Quantity
=P3	ø330mm Embossed Taping	1000

Part Number (□: packaging code)	Inductance	Inductance Test Frequency	Rated Current (Isat)*	Rated Current (Itemp)*	Max. of DC Resistance
FDVE0630-H-R16M□	0.16μH ±20%	0.1MHz	19400mA	20700mA	0.0016Ω
FDVE0630-H-R33M□	0.33μH ±20%	0.1MHz	15900mA	16900mA	0.0027Ω
FDVE0630-H-R47M□	0.47μH ±20%	0.1MHz	15600mA	14100mA	0.0037Ω
FDVE0630-H-R68M□	0.68μH ±20%	0.1MHz	10400mA	11900mA	0.0060Ω
FDVE0630-H-R75M□	0.75μH ±20%	0.1MHz	10900mA	10700mA	0.0062Ω
FDVE0630-H-1R0M□	1.0μH ±20%	0.1MHz	9500mA	9500mA	0.0085Ω
FDVE0630-H-1R5M□	1.5μH ±20%	0.1MHz	8100mA	8000mA	0.0121Ω
FDVE0630-H-2R2M□	2.2μH ±20%	0.1MHz	6900mA	6600mA	0.0162Ω
FDVE0630-H-3R3M□	3.3μH ±20%	0.1MHz	5300mA	5300mA	0.0254Ω
FDVE0630-H-4R7M□	4.7μH ±20%	0.1MHz	4600mA	4400mA	0.0361Ω
FDVE0630-H-6R8M□	6.8μH ±20%	0.1MHz	3400mA	3600mA	0.0542Ω
FDVE0630-H-100M□	10μH ±20%	0.1MHz	3100mA	2800mA	0.0792Ω

Absolute maximum voltage: 30V DC

Operating temp. range (Self-temp. rise included): -40 to 125°C

Class of Magnetic Shield: Metal Alloy

Only for reflow soldering

*Isat: Rated Current based on Inductance change

*Itemp: Rated Current based on Temperature rise

Rated current (Isat) is specified when the decrease of the initial inductance value at 20%. Rated current (Itemp) is specified when temperature of the inductor is raised 40°C by DC current.

Inductance-Current Characteristics (Typ.)



Temperature Rise Characteristics (Typ.)



FDVE0630

Inductors for Power Lines

Inductors for General Circuits

RF Inductors

FDVE0640 Series 2926 (7467) inch (mm)



Packaging Code	Packaging	Minimum Quantity
=P3	ø330mm Embossed Taping	1000

Part Number (□: packaging code)	Inductance	Inductance Test Frequency	Rated Current (Isat)*	Rated Current (Itemp)*	Max. of DC Resistance
FDVE0640-H-1R5M□	1.5μH ±20%	0.1MHz	8000mA	8200mA	0.0103Ω
FDVE0640-H-2R2M□	2.2μH ±20%	0.1MHz	7600mA	6500mA	0.0163Ω
FDVE0640-H-3R3M□	3.3μH ±20%	0.1MHz	6000mA	5600mA	0.0192Ω
FDVE0640-H-4R7M□	4.7μH ±20%	0.1MHz	4600mA	5000mA	0.0292Ω

Absolute maximum voltage: 30V DC
 Operating temp. range (Self-temp. rise included): -40 to 125°C
 Class of Magnetic Shield: Metal Alloy
 Only for reflow soldering
 *Isat: Rated Current based on Inductance change
 *Itemp: Rated Current based on Temperature rise
 Rated current (Isat) is specified when the decrease of the initial inductance value at 20%. Rated current (Itemp) is specified when temperature of the inductor is raised 40°C by DC current.

Inductance-Current Characteristics (Typ.)



Temperature Rise Characteristics (Typ.)



FDUE0630 Series 3026 (7667) inch (mm)



Packaging Code	Packaging	Minimum Quantity
=P3	ø330mm Embossed Taping	1000

Continued on the following page. ↗

Continued from the preceding page. ↘

Part Number (□: packaging code)	Inductance	Inductance Test Frequency	Rated Current (Isat)*	Rated Current (Itemp)*	DC Resistance
FDUE0630-H-R12M□	0.12μH ±20%	0.1MHz	33000mA	36000mA	0.00058Ω±7%
FDUE0630-H-R24M□	0.24μH ±20%	0.1MHz	23000mA	27000mA	0.00112Ω±7%

Absolute maximum voltage: 30V DC

Operating temp. range (Self-temp. rise included): -40 to 125°C

Class of Magnetic Shield: Metal Alloy

Only for reflow soldering

*Isat: Rated Current based on Inductance change

*Itemp: Rated Current based on Temperature rise

Rated current (Isat) is specified when the decrease of the initial inductance value at 30%. Rated current (Itemp) is specified when temperature of the inductor is raised 40°C by DC current.

Inductance-Current Characteristics (Typ.)



Temperature Rise Characteristics (Typ.)



FDUE0640 Series 3026 (7667) inch (mm)



Packaging Code	Packaging	Minimum Quantity
=P3	ø330mm Embossed Taping	1000

Part Number (□: packaging code)	Inductance	Inductance Test Frequency	Rated Current (Isat)*	Rated Current (Itemp)*	DC Resistance
FDUE0640-H-KR15M□	0.15μH ±20%	0.1MHz	25000mA	33000mA	0.00061Ω±7%
FDUE0640-H-R24M□	0.24μH ±20%	0.1MHz	19000mA	27000mA	0.00089Ω±7%
FDUE0640-H-R42M□	0.42μH ±20%	0.1MHz	15000mA	22000mA	0.00148Ω±7%

Absolute maximum voltage: 30V DC

Operating temp. range (Self-temp. rise included): -40 to 125°C

Class of Magnetic Shield: Metal Alloy

Only for reflow soldering

*Isat: Rated Current based on Inductance change

*Itemp: Rated Current based on Temperature rise

Rated current (Isat) is specified when the decrease of the initial inductance value at 20%. Rated current (Itemp) is specified when temperature of the inductor is raised 40°C by DC current.

Inductance-Current Characteristics (Typ.)



Temperature Rise Characteristics (Typ.)



FDUE0650 Series 3026 (7667) inch (mm)



Packaging Code	Packaging	Minimum Quantity
=P3	ø330mm Embossed Taping	1000

Part Number (□: packaging code)	Terminal Dimensions
FDUE0650-H-R60M□	A:2.7mm
FDUE0650-H-1R0M□	A:2.4mm

Part Number (□: packaging code)	Inductance	Inductance Test Frequency	Rated Current (Isat)*	Rated Current (Itemp)*	DC Resistance
FDUE0650-H-R60M□	0.6μH ±20%	0.1MHz	12000mA	18000mA	0.00224Ω±10%
FDUE0650-H-1R0M□	1.0μH ±20%	0.1MHz	9800mA	16000mA	0.00338Ω±10%

Absolute maximum voltage: 30V DC

Operating temp. range (Self-temp. rise included): -40 to 125°C

Class of Magnetic Shield: Metal Alloy

Only for reflow soldering

*Isat: Rated Current based on Inductance change

*Itemp: Rated Current based on Temperature rise

Rated current (Isat) is specified when the decrease of the initial inductance value at 20%. Rated current (Itemp) is specified when temperature of the inductor is raised 40°C by DC current.

Inductance-Current Characteristics (Typ.)



Temperature Rise Characteristics (Typ.)



FDA1055 Series 4242 (108108) inch (mm)



Packaging Code	Packaging	Minimum Quantity
=P3	ø330mm Embossed Taping	500

Part Number (□: packaging code)	Terminal Dimensions
FDA1055-H-R56M□	A:11.6mm B:1.9mm C:6.5mm
FDA1055-H-1R2M□	A:11.6mm B:1.9mm C:6.5mm
FDA1055-H-1R5M□	A:11.6mm B:1.9mm C:6.5mm
FDA1055-H-2R2M□	A:11.4mm B:1.7mm C:6.4mm
FDA1055-H-3R3M□	A:11.3mm B:1.4mm C:6.4mm
FDA1055-H-4R7M□	A:11.3mm B:1.4mm C:6.4mm
FDA1055-H-5R6M□	A:11.3mm B:1.4mm C:6.4mm

Continued on the following page. ↗

Continued from the preceding page. ↘

Part Number (□: packaging code)	Inductance	Inductance Test Frequency	Rated Current (Isat)*	Rated Current (Itemp)*	Max. of DC Resistance
FDA1055-H-R56M□	0.56μH ±20%	0.1MHz	27700mA	22700mA	0.0018Ω
FDA1055-H-1R2M□	1.2μH ±20%	0.1MHz	20000mA	17900mA	0.0029Ω
FDA1055-H-1R5M□	1.5μH ±20%	0.1MHz	18000mA	16600mA	0.0035Ω
FDA1055-H-2R2M□	2.2μH ±20%	0.1MHz	15500mA	13600mA	0.0048Ω
FDA1055-H-3R3M□	3.3μH ±20%	0.1MHz	11700mA	11200mA	0.0073Ω
FDA1055-H-4R7M□	4.7μH ±20%	0.1MHz	9900mA	9100mA	0.0110Ω
FDA1055-H-5R6M□	5.6μH ±20%	0.1MHz	8000mA	7500mA	0.0120Ω

Absolute maximum voltage: 30V DC

Operating temp. range (Self-temp. rise included): -40 to 125°C

Class of Magnetic Shield: Metal Alloy

Only for reflow soldering

*Isat: Rated Current based on Inductance change

*Itemp: Rated Current based on Temperature rise

Rated current (Isat) is specified when the decrease of the initial inductance value at 30%. Rated current (Itemp) is specified when temperature of the inductor is raised 40°C by DC current.

Inductance-Frequency Characteristics (Typ.)



Inductance-Current Characteristics (Typ.)



Temperature Rise Characteristics (Typ.)



FDUE1040D Series 4440 (112100) inch (mm)



Packaging Code	Packaging	Minimum Quantity
-P3	ø330mm Embossed Taping	500

Part Number (□: packaging code)	Inductance	Inductance Test Frequency	Rated Current (Isat)*	Rated Current (Itemp)*	DC Resistance
FDUE1040D-H-R22M□	0.22μH ±20%	0.1MHz	32000mA	32000mA	0.00064Ω±7%
FDUE1040D-H-R36M□	0.36μH ±20%	0.1MHz	25000mA	30000mA	0.00079Ω±7%
FDUE1040D-H-R45M□	0.45μH ±20%	0.1MHz	24000mA	27000mA	0.00102Ω±7%
FDUE1040D-H-R56M□	0.56μH ±20%	0.1MHz	24000mA	25000mA	0.00124Ω±7%
FDUE1040D-H-1R0M□	1.0μH ±20%	0.1MHz	16000mA	18000mA	0.00235Ω±7%

Absolute maximum voltage: 30V DC

Operating temp. range (Self-temp. rise included): -40 to 125°C

Class of Magnetic Shield: Metal Alloy

Only for reflow soldering

*Isat: Rated Current based on Inductance change

*Itemp: Rated Current based on Temperature rise

Rated current (Isat) is specified when the decrease of the initial inductance value at 20%. Rated current (Itemp) is specified when temperature of the inductor is raised 40°C by DC current.

Continued on the following page. ↗

Continued from the preceding page. ↘

Inductance-Current Characteristics (Typ.)



Temperature Rise Characteristics (Typ.)



FDVE1040 Series 4440 (112100) inch (mm)



Packaging Code	Packaging	Minimum Quantity
=P3	ø330mm Embossed Taping	500

Part Number (□: packaging code)	Inductance	Inductance Test Frequency	Rated Current (Isat)*	Rated Current (Itemp)*	Max. of DC Resistance
FDVE1040-H-1R5M□	1.5µH ±20%	0.1MHz	13700mA	14600mA	0.0046Ω
FDVE1040-H-2R2M□	2.2µH ±20%	0.1MHz	11400mA	11600mA	0.0068Ω
FDVE1040-H-2R7M□	2.7µH ±20%	0.1MHz	10900mA	10500mA	0.0088Ω
FDVE1040-H-3R3M□	3.3µH ±20%	0.1MHz	9800mA	9000mA	0.0101Ω
FDVE1040-H-4R7M□	4.7µH ±20%	0.1MHz	8200mA	8000mA	0.0138Ω
FDVE1040-H-5R6M□	5.6µH ±20%	0.1MHz	7900mA	7300mA	0.0180Ω
FDVE1040-H-6R8M□	6.8µH ±20%	0.1MHz	7100mA	7100mA	0.0202Ω
FDVE1040-H-100M□	10µH ±20%	0.1MHz	6100mA	5200mA	0.0341Ω

Absolute maximum voltage: 30V DC

Operating temp. range (Self-temp. rise included): -40 to 125°C

Class of Magnetic Shield: Metal Alloy

Only for reflow soldering

*Isat: Rated Current based on Inductance change

*Itemp: Rated Current based on Temperature rise

Rated current (Isat) is specified when the decrease of the initial inductance value at 20%. Rated current (Itemp) is specified when temperature of the inductor is raised 40°C by DC current.

Inductance-Current Characteristics (Typ.)



Temperature Rise Characteristics (Typ.)



FCUL1040 Series 4540 (115100) inch (mm)



Packaging Code	Packaging	Minimum Quantity
=P3	ø330mm Embossed Taping	500

Part Number (□: packaging code)	Terminal Dimensions
FCUL1040-H-R18M□	A:3.9mm
FCUL1040-H-R36M□	A:3.9mm
FCUL1040-H-R42M□	A:3.5mm

Part Number (□: packaging code)	Inductance	Inductance Test Frequency	Rated Current (Isat)*	Rated Current (Itemp)*	DC Resistance
FCUL1040-H-R18M□	0.18μH ±20%	0.1MHz	53000mA	38000mA	0.00054Ω±7%
FCUL1040-H-R36M□	0.36μH ±20%	0.1MHz	36000mA	31000mA	0.00082Ω±7%
FCUL1040-H-R42M□	0.42μH ±20%	0.1MHz	34000mA	30000mA	0.00102Ω±7%

Absolute maximum voltage: 30V DC

Operating temp. range (Self-temp. rise included): -40 to 125°C

Class of Magnetic Shield: Metal Alloy

Only for reflow soldering

*Isat: Rated Current based on Inductance change

*Itemp: Rated Current based on Temperature rise

Rated current (Isat) is specified when the decrease of the initial inductance value at 30%. Rated current (Itemp) is specified when temperature of the inductor is raised 40°C by DC current.

Inductance-Frequency Characteristics (Typ.)



Inductance-Current Characteristics (Typ.)



Temperature Rise Characteristics (Typ.)



FCUL1060 Series 4640 (116100) inch (mm)



Packaging Code	Packaging	Minimum Quantity
=P3	ø330mm Embossed Taping	500

Continued on the following page. ↗

FCUL1040
Inductors for Power Lines

Inductors for General Circuits

RF Inductors

Continued from the preceding page. ↘

Part Number (□: packaging code)	Inductance	Inductance Test Frequency	Rated Current (Isat)*	Rated Current (Itemp)*	DC Resistance
FCUL1060-H-R36M □	0.36μH ±20%	0.1MHz	41000mA	41000mA	0.00053Ω±7%
FCUL1060-H-R56M □	0.56μH ±20%	0.1MHz	34000mA	30000mA	0.00085Ω±7%

Absolute maximum voltage: 30V DC

Operating temp. range (Self-temp. rise included): -40 to 125°C

Class of Magnetic Shield: Metal Alloy

Only for reflow soldering

*Isat: Rated Current based on Inductance change

*Itemp: Rated Current based on Temperature rise

Rated current (Isat) is specified when the decrease of the initial inductance value at 30%. Rated current (Itemp) is specified when temperature of the inductor is raised 40°C by DC current.

Inductance-Frequency Characteristics (Typ.)



Inductance-Current Characteristics (Typ.)



Temperature Rise Characteristics (Typ.)

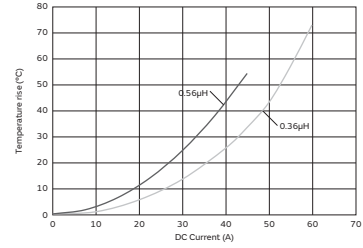

FDUE1245 Series 4848 (123121) inch (mm)



Packaging Code	Packaging	Minimum Quantity
=P3	ø330mm Embossed Taping	500

Part Number (□: packaging code)	Terminal Dimensions
FDUE1245-H-R50M □	A:13.4mm B:2.2mm
FDUE1245-H-R72M □	A:13.4mm B:2.2mm
FDUE1245-H-1R0M □	A:13.2mm B:2.1mm
FDUE1245-H-1R5M □	A:13.2mm B:2.1mm
FDUE1245-H-2R2M □	A:13.2mm B:2.1mm

Part Number (□: packaging code)	Inductance	Inductance Test Frequency	Rated Current (Isat)*	Rated Current (Itemp)*	DC Resistance
FDUE1245-H-R50M □	0.5μH ±20%	0.1MHz	28000mA	30000mA	0.0008Ω±7%
FDUE1245-H-R72M □	0.72μH ±20%	0.1MHz	24000mA	22000mA	0.00163Ω±7%
FDUE1245-H-1R0M □	1.0μH ±20%	0.1MHz	21000mA	21000mA	0.0017Ω±7%
FDUE1245-H-1R5M □	1.5μH ±20%	0.1MHz	17000mA	20000mA	0.00226Ω±7%
FDUE1245-H-2R2M □	2.2μH ±20%	0.1MHz	14000mA	17000mA	0.0034Ω±7%

Absolute maximum voltage: 30V DC

Operating temp. range (Self-temp. rise included): -40 to 125°C

Class of Magnetic Shield: Metal Alloy

Only for reflow soldering

*Isat: Rated Current based on Inductance change

*Itemp: Rated Current based on Temperature rise

Rated current (Isat) is specified when the decrease of the initial inductance value at 20%. Rated current (Itemp) is specified when temperature of the inductor is raised 40°C by DC current.

Continued on the following page. ↗

Continued from the preceding page. ↘

Inductance-Current Characteristics (Typ.)



Temperature Rise Characteristics (Typ.)



FDA1254 Series 5049 (126125) inch (mm)



Packaging Code	Packaging	Minimum Quantity
=P3	ø330mm Embossed Taping	500

Part Number (□: packaging code)	Terminal Dimensions
FDA1254-H-R68M□	A:13.5mm B:1.8mm C:7.7mm
FDA1254-H-1R0M□	A:13.5mm B:1.8mm C:7.7mm
FDA1254-H-1R2M□	A:13.5mm B:1.8mm C:7.7mm
FDA1254-H-2R2M□	A:13.2mm B:1.5mm C:7.6mm
FDA1254-H-3R3M□	A:12.9mm B:1.2mm C:7.6mm
FDA1254-H-4R7M□	A:12.9mm B:1.2mm C:7.6mm
FDA1254-H-5R6M□	A:12.9mm B:1.2mm C:7.6mm
FDA1254-H-8R0M□	A:12.9mm B:1.2mm C:7.6mm

Part Number (□: packaging code)	Inductance	Inductance Test Frequency	Rated Current (Isat)*	Rated Current (Itemp)*	Max. of DC Resistance
FDA1254-H-R68M□	0.68µH ±20%	0.1MHz	29100mA	23700mA	0.0015Ω
FDA1254-H-1R0M□	1.0µH ±20%	0.1MHz	25200mA	20500mA	0.0020Ω
FDA1254-H-1R2M□	1.2µH ±20%	0.1MHz	20200mA	18400mA	0.0026Ω
FDA1254-H-2R2M□	2.2µH ±20%	0.1MHz	14700mA	14200mA	0.0045Ω
FDA1254-H-3R3M□	3.3µH ±20%	0.1MHz	13100mA	11500mA	0.0070Ω
FDA1254-H-4R7M□	4.7µH ±20%	0.1MHz	11200mA	10200mA	0.0088Ω
FDA1254-H-5R6M□	5.6µH ±20%	0.1MHz	10800mA	9100mA	0.0094Ω
FDA1254-H-8R0M□	8.0µH ±20%	0.1MHz	9100mA	7100mA	0.0160Ω

Absolute maximum voltage: 30V DC

Operating temp. range (Self-temp. rise included): -40 to 125°C

Class of Magnetic Shield: Metal Alloy

Only for reflow soldering

*Isat: Rated Current based on Inductance change

*Itemp: Rated Current based on Temperature rise

Rated current (Isat) is specified when the decrease of the initial inductance value at 30%. Rated current (Itemp) is specified when temperature of the inductor is raised 40°C by DC current.

Inductance-Current Characteristics (Typ.)

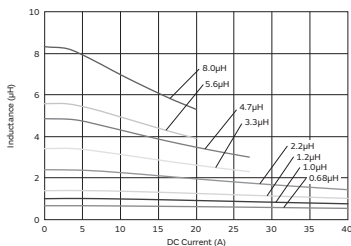

Temperature Rise Characteristics (Typ.)



FDUE1260 Series 5650 (143127) inch (mm)



Packaging Code	Packaging	Minimum Quantity
=P3	ø330mm Embossed Taping	500

Part Number (□: packaging code)	Inductance	Inductance Test Frequency	Rated Current (Isat)*	Rated Current (Itemp)*	DC Resistance
FDUE1260-H-R45N□	0.45μH ±30%	0.1MHz	32000mA	34000mA	0.00058Ω±7%

Absolute maximum voltage: 30V DC

Operating temp. range (Self-temp. rise included): -40 to 125°C

Class of Magnetic Shield: Metal Alloy

Only for reflow soldering

*Isat: Rated Current based on Inductance change

*Itemp: Rated Current based on Temperature rise

Rated current (Isat) is specified when the decrease of the initial inductance value at 30%. Rated current (Itemp) is specified when temperature of the inductor is raised 40°C by DC current.

Inductance-Frequency Characteristics (Typ.)



Inductance-Current Characteristics (Typ.)



Temperature Rise Characteristics (Typ.)



LQW15DN_00 Series 0402 (1005) inch (mm)



Packaging Code	Packaging	Minimum Quantity
D	ø180mm Paper Taping	8000
B	Packing in Bulk	500

Continued on the following page. ↗

Continued from the preceding page. ↘

Part Number (□: packaging code)	Inductance	Inductance Test Frequency	Rated Current (Isat)*	Rated Current (Itemp)*	DC Resistance	S.R.F.* (min.)
LQW15DN100M00□	10μH ±20%	10MHz	120mA	120mA	4.7Ω±15%	20MHz
LQW15DN150M00□	15μH ±20%	10MHz	100mA	100mA	5.7Ω±15%	20MHz

Operating temp. range: -40 to 85°C
 Class of Magnetic Shield: Magnetic Resin
 Only for reflow soldering

*Isat: Rated Current based on Inductance change
 *Itemp: Rated Current based on Temperature rise
 *S.R.F.: Self Resonant Frequency

When rated current is applied to the products, inductance will be within ±30% of nominal inductance value. When rated current is applied to the products, the temperature rise caused by self-generated heat shall be limited to 40°C max.

Inductance-Frequency Characteristics (Typ.)



Impedance-Frequency Characteristics (Typ.)



LQH2MCN_02 Series 0806 (2016) inch (mm)



(in mm)

Packaging Code	Packaging	Minimum Quantity
L	ø180mm Embossed Taping	3000
B	Packing in Bulk	100

Part Number (□: packaging code)	Inductance	Inductance Test Frequency	Rated Current	DC Resistance	S.R.F.* (min.)
LQH2MCN1R0M02□	1.0μH ±20%	1MHz	485mA	0.30Ω±30%	100MHz
LQH2MCN1R5M02□	1.5μH ±20%	1MHz	445mA	0.40Ω±30%	95MHz
LQH2MCN2R2M02□	2.2μH ±20%	1MHz	425mA	0.48Ω±30%	70MHz
LQH2MCN3R3M02□	3.3μH ±20%	1MHz	375mA	0.60Ω±30%	65MHz
LQH2MCN4R7M02□	4.7μH ±20%	1MHz	300mA	0.8Ω±30%	60MHz
LQH2MCN5R6M02□	5.6μH ±20%	1MHz	280mA	0.9Ω±30%	60MHz
LQH2MCN6R8M02□	6.8μH ±20%	1MHz	255mA	1.0Ω±30%	55MHz
LQH2MCN8R2M02□	8.2μH ±20%	1MHz	235mA	1.1Ω±30%	50MHz
LQH2MCN100K02□	10μH ±10%	1MHz	225mA	1.2Ω±30%	48MHz
LQH2MCN120K02□	12μH ±10%	1MHz	210mA	1.4Ω±30%	44MHz
LQH2MCN150K02□	15μH ±10%	1MHz	200mA	1.6Ω±30%	40MHz
LQH2MCN180K02□	18μH ±10%	1MHz	190mA	1.8Ω±30%	35MHz

Operating temp. range: -40 to 85°C
 Class of Magnetic Shield: No Shield
 Only for reflow soldering

*S.R.F.: Self Resonant Frequency

When rated current is applied to the products, inductance will be within ±10% of initial inductance value. When rated current is applied to the products, the temperature rise caused by self-generated heat shall be limited to 40°C max.

Continued on the following page. ↗

Continued from the preceding page. ↘

Part Number (□: packaging code)	Inductance	Inductance Test Frequency	Rated Current	DC Resistance	S.R.F.* (min.)
LQH2MCN220K02□	22μH ±10%	1MHz	185mA	2.1Ω±30%	30MHz
LQH2MCN270K02□	27μH ±10%	1MHz	180mA	2.5Ω±30%	30MHz
LQH2MCN330K02□	33μH ±10%	1MHz	160mA	2.8Ω±30%	28MHz
LQH2MCN390K02□	39μH ±10%	1MHz	125mA	4.4Ω±30%	24MHz
LQH2MCN470K02□	47μH ±10%	1MHz	120mA	5.1Ω±30%	18MHz
LQH2MCN560K02□	56μH ±10%	1MHz	110mA	5.7Ω±30%	17MHz
LQH2MCN680K02□	68μH ±10%	1MHz	100mA	6.6Ω±30%	14MHz
LQH2MCN820K02□	82μH ±10%	1MHz	90mA	7.5Ω±30%	14MHz

Operating temp. range: -40 to 85°C

Class of Magnetic Shield: No Shield

Only for reflow soldering

*S.R.F.: Self Resonant Frequency

When rated current is applied to the products, inductance will be within ±10% of initial inductance value. When rated current is applied to the products, the temperature rise caused by self-generated heat shall be limited to 40°C max.

Inductance-Frequency Characteristics (Typ.)



Inductance-Current Characteristics (Typ.)



Temperature Rise Characteristics (Typ.)



LQH2MCN_52 Series 0806 (2016) inch (mm)



Packaging Code	Packaging	Minimum Quantity
L	ø180mm Embossed Taping	3000
B	Packing in Bulk	100

Part Number (□: packaging code)	Inductance	Inductance Test Frequency	Rated Current	DC Resistance	S.R.F.* (min.)
LQH2MCN1R0M52□	1.0μH ±20%	1MHz	595mA	0.25Ω±30%	215MHz
LQH2MCN1R5M52□	1.5μH ±20%	1MHz	540mA	0.33Ω±30%	165MHz
LQH2MCN2R2M52□	2.2μH ±20%	1MHz	500mA	0.42Ω±30%	125MHz
LQH2MCN3R3M52□	3.3μH ±20%	1MHz	360mA	0.74Ω±30%	110MHz
LQH2MCN4R7M52□	4.7μH ±20%	1MHz	335mA	0.91Ω±30%	90MHz
LQH2MCN6R8M52□	6.8μH ±20%	1MHz	285mA	1.23Ω±30%	65MHz
LQH2MCN100M52□	10μH ±20%	1MHz	200mA	2.27Ω±30%	60MHz
LQH2MCN120M52□	12μH ±20%	1MHz	170mA	2.4Ω±30%	30MHz

Operating temp. range: -40 to 85°C

Class of Magnetic Shield: No Shield

Only for reflow soldering

*S.R.F.: Self Resonant Frequency

When rated current is applied to the products, inductance will be within ±10% of initial inductance value. When rated current is applied to the products, the temperature rise caused by self-generated heat shall be limited to 40°C max.

Continued from the preceding page. ↘

Part Number (□: packaging code)	Inductance	Inductance Test Frequency	Rated Current	DC Resistance	S.R.F.* (min.)
LQH2MCN150M52□	15μH ±20%	1MHz	150mA	3.5Ω±30%	30MHz
LQH2MCN180M52□	18μH ±20%	1MHz	140mA	4.0Ω±30%	30MHz
LQH2MCN220M52□	22μH ±20%	1MHz	130mA	5.5Ω±30%	30MHz

Operating temp. range: -40 to 85°C

Class of Magnetic Shield: No Shield

Only for reflow soldering

*S.R.F.: Self Resonant Frequency

When rated current is applied to the products, inductance will be within ±10% of initial inductance value. When rated current is applied to the products, the temperature rise caused by self-generated heat shall be limited to 40°C max.

Inductance-Frequency Characteristics (Typ.)



Inductance-Current Characteristics (Typ.)



Temperature Rise Characteristics (Typ.)



LQH2MPN_GR Series 0806 (2016) inch (mm)



Packaging Code	Packaging	Minimum Quantity
L	ø180mm Embossed Taping	3000

Part Number (□: packaging code)	Inductance	Inductance Test Frequency	Rated Current (I _{sat})*	Rated Current (I _{temp})*	DC Resistance	S.R.F.* (min.)
LQH2MPNR33NGR□	0.33μH ±30%	1MHz	2200mA	1130mA(Ambient temp.85°C) 670mA(Ambient temp.105°C)	0.15Ω±20%	130MHz
LQH2MPNR47NGR□	0.47μH ±30%	1MHz	1950mA	1060mA(Ambient temp.85°C) 630mA(Ambient temp.105°C)	0.18Ω±20%	120MHz
LQH2MPN1R0NGR□	1.0μH ±30%	1MHz	1550mA	900mA(Ambient temp.85°C) 540mA(Ambient temp.105°C)	0.25Ω±20%	100MHz
LQH2MPN1R5NGR□	1.5μH ±30%	1MHz	1330mA	790mA(Ambient temp.85°C) 470mA(Ambient temp.105°C)	0.32Ω±20%	60MHz
LQH2MPN2R2MGR□	2.2μH ±20%	1MHz	1180mA	680mA(Ambient temp.85°C) 400mA(Ambient temp.105°C)	0.39Ω±20%	50MHz

Operating temp. range (Self-temp. rise included): -40 to 125°C

Operating temp. range (Self-temp. rise not included): -40 to 105°C

Class of Magnetic Shield: Ferrite Core

Only for reflow soldering

*I_{sat}: Rated Current based on Inductance change

*I_{temp}: Rated Current based on Temperature rise

*S.R.F.: Self Resonant Frequency

When rated current is applied to the products, inductance will be within ±30% of initial inductance value range. Keep the temperature (ambient temperature plus self-generation of heat) under 125°C. When rated current is applied to the products, the self-temperature rise shall be limited to 40°C max. (ambient temperature 85°C). When rated current is applied to the products, the self-temperature rise shall be limited to 20°C max. (ambient temperature 85 °C to 105°C).

Continued on the following page. ↗

Continued from the preceding page. ↘

Part Number (□: packaging code)	Inductance	Inductance Test Frequency	Rated Current (Isat)*	Rated Current (Itemp)*	DC Resistance	S.R.F.* (min.)
LQH2MPN3R3MGR□	3.3μH ±20%	1MHz	1020mA	640mA(Ambient temp.85°C) 380mA(Ambient temp.105°C)	0.47Ω±20%	45MHz
LQH2MPN4R7MGR□	4.7μH ±20%	1MHz	870mA	580mA(Ambient temp.85°C) 340mA(Ambient temp.105°C)	0.60Ω±20%	40MHz
LQH2MPN6R8MGR□	6.8μH ±20%	1MHz	730mA	530mA(Ambient temp.85°C) 310mA(Ambient temp.105°C)	0.72Ω±20%	35MHz
LQH2MPN100MGR□	10μH ±20%	1MHz	610mA	480mA(Ambient temp.85°C) 280mA(Ambient temp.105°C)	0.88Ω±20%	30MHz
LQH2MPN150MGR□	15μH ±20%	1MHz	490mA	340mA(Ambient temp.85°C) 200mA(Ambient temp.105°C)	1.7Ω±20%	25MHz
LQH2MPN220MGR□	22μH ±20%	1MHz	410mA	290mA(Ambient temp.85°C) 170mA(Ambient temp.105°C)	2.1Ω±20%	20MHz
LQH2MPN330MGR□	33μH ±20%	1MHz	310mA	200mA(Ambient temp.85°C) 120mA(Ambient temp.105°C)	4.3Ω±20%	15MHz
LQH2MPN470MGR□	47μH ±20%	1MHz	270mA	180mA(Ambient temp.85°C) 110mA(Ambient temp.105°C)	5.3Ω±20%	10MHz
LQH2MPN680MGR□	68μH ±20%	1MHz	230mA	160mA(Ambient temp.85°C) 100mA(Ambient temp.105°C)	6.7Ω±20%	7MHz
LQH2MPN820MGR□	82μH ±20%	1MHz	210mA	150mA(Ambient temp.85°C) 90mA(Ambient temp.105°C)	7.3Ω±20%	5MHz

Operating temp. range (Self-temp. rise included): -40 to 125°C
 Operating temp. range (Self-temp. rise not included): -40 to 105°C
 Class of Magnetic Shield: Ferrite Core

Only for reflow soldering

*Isat: Rated Current based on Inductance change

*Itemp: Rated Current based on Temperature rise

*S.R.F.: Self Resonant Frequency

When rated current is applied to the products, inductance will be within ±30% of initial inductance value range. Keep the temperature (ambient temperature plus self-generation of heat) under 125°C. When rated current is applied to the products, the self-temperature rise shall be limited to 40°C max. (ambient temperature 85°C). When rated current is applied to the products, the self-temperature rise shall be limited to 20°C max. (ambient temperature 85 °C to 105°C).

Inductance-Frequency Characteristics (Typ.)



Inductance-Current Characteristics (Typ.)



Temperature Rise Characteristics (Typ.)



Inductors for Power Lines LQH2MPN_GR
 Inductors for General Circuits
 RF Inductors

LQH2HPN_DR Series 1008 (2520) inch (mm)

LQH2HPN_DR
 Inductors for Power Lines

Inductors for General Circuits

RF Inductors



Packaging Code	Packaging	Minimum Quantity
L	ø180mm Embossed Taping	4000

Part Number (□: packaging code)	Inductance	Inductance Test Frequency	Rated Current (I _{sat})*	Rated Current (I _{temp})*	DC Resistance	S.R.F.* (min.)
LQH2HPNR47MDR□	0.47μH ±20%	1MHz	1670mA	1250mA(Ambient temp.85°C) 750mA(Ambient temp.105°C)	0.14Ω±20%	120MHz
LQH2HPN1R0MDR□	1.0μH ±20%	1MHz	1370mA	960mA(Ambient temp.85°C) 580mA(Ambient temp.105°C)	0.24Ω±20%	100MHz
LQH2HPN1R5MDR□	1.5μH ±20%	1MHz	1120mA	900mA(Ambient temp.85°C) 540mA(Ambient temp.105°C)	0.29Ω±20%	60MHz
LQH2HPN2R2MDR□	2.2μH ±20%	1MHz	850mA	820mA(Ambient temp.85°C) 500mA(Ambient temp.105°C)	0.34Ω±20%	50MHz
LQH2HPN3R3MDR□	3.3μH ±20%	1MHz	750mA	730mA(Ambient temp.85°C) 440mA(Ambient temp.105°C)	0.45Ω±20%	45MHz
LQH2HPN4R7MDR□	4.7μH ±20%	1MHz	650mA	650mA(Ambient temp.85°C) 390mA(Ambient temp.105°C)	0.56Ω±20%	40MHz
LQH2HPN6R8MDR□	6.8μH ±20%	1MHz	550mA	490mA(Ambient temp.85°C) 300mA(Ambient temp.105°C)	1.0Ω±20%	35MHz
LQH2HPN100MDR□	10μH ±20%	1MHz	420mA	430mA(Ambient temp.85°C) 260mA(Ambient temp.105°C)	1.2Ω±20%	30MHz
LQH2HPN150MDR□	15μH ±20%	1MHz	340mA	290mA(Ambient temp.85°C) 180mA(Ambient temp.105°C)	2.5Ω±20%	25MHz
LQH2HPN220MDR□	22μH ±20%	1MHz	260mA	270mA(Ambient temp.85°C) 170mA(Ambient temp.105°C)	3.0Ω±20%	20MHz

Operating temp. range (Self-temp. rise included): -40 to 125°C
 Operating temp. range (Self-temp. rise not included): -40 to 105°C
 Class of Magnetic Shield: Magnetic Resin
 Only for reflow soldering

*I_{sat}: Rated Current based on Inductance change
 *I_{temp}: Rated Current based on Temperature rise
 *S.R.F.: Self Resonant Frequency

When rated current is applied to the products, inductance will be within ±30% of initial inductance value range. Keep the temperature (ambient temperature plus self-generation of heat) under 125°C. When rated current is applied to the products, the self-temperature rise shall be limited to 40°C max. (ambient temperature 85°C). When rated current is applied to the products, the self-temperature rise shall be limited to 20°C max. (ambient temperature 85 °C to 105°C).

Inductance-Frequency Characteristics (Typ.)



Inductance-Current Characteristics (Typ.)



Temperature Rise Characteristics (Typ.)



LQH2HPN_GR Series 1008 (2520) inch (mm)



Packaging Code	Packaging	Minimum Quantity
L	ø180mm Embossed Taping	3000

Part Number (□: packaging code)	Inductance	Inductance Test Frequency	Rated Current (I _{sat})*	Rated Current (I _{temp})*	DC Resistance	S.R.F.* (min.)	Operating temp. range (Self-temp. rise included)	Operating temp. range (Self-temp. rise not included)	Remark
LQH2HPNR47MGR□	0.47μH ±20%	1MHz	2900mA	2520mA(Ambient temp.85°C) 1470mA(Ambient temp.105°C)	0.045Ω±20%	120MHz	-40 to 125°C	-40 to 105°C	*1
LQH2HPNR68MGR□	0.68μH ±20%	1MHz	2430mA	2330mA(Ambient temp.85°C) 1350mA(Ambient temp.105°C)	0.055Ω±20%	110MHz	-40 to 125°C	-40 to 105°C	*1
LQH2HPN1R0MGR□	1.0μH ±20%	1MHz	2130mA	2100mA(Ambient temp.85°C) 1200mA(Ambient temp.105°C)	0.068Ω±20%	100MHz	-40 to 125°C	-40 to 105°C	*1
LQH2HPN1R5MGR□	1.5μH ±20%	1MHz	1700mA	1850mA(Ambient temp.85°C) 1110mA(Ambient temp.105°C)	0.087Ω±20%	90MHz	-40 to 125°C	-40 to 105°C	*1
LQH2HPN2R2MGR□	2.2μH ±20%	1MHz	1550mA	1470mA(Ambient temp.85°C) 850mA(Ambient temp.105°C)	0.134Ω±20%	80MHz	-40 to 125°C	-40 to 105°C	*1
LQH2HPN3R3MGR□	3.3μH ±20%	1MHz	1230mA	1100mA(Ambient temp.85°C) 660mA(Ambient temp.105°C)	0.225Ω±20%	70MHz	-40 to 125°C	-40 to 105°C	*1
LQH2HPN4R7MGR□	4.7μH ±20%	1MHz	1090mA	1000mA(Ambient temp.85°C) 570mA(Ambient temp.105°C)	0.300Ω±20%	50MHz	-40 to 125°C	-40 to 105°C	*1
LQH2HPN6R8MGR□	6.8μH ±20%	1MHz	830mA	860mA(Ambient temp.85°C) 490mA(Ambient temp.105°C)	0.395Ω±20%	40MHz	-40 to 125°C	-40 to 105°C	*1
LQH2HPN100MGR□	10μH ±20%	1MHz	700mA	710mA(Ambient temp.85°C) 430mA(Ambient temp.105°C)	0.560Ω±20%	30MHz	-40 to 125°C	-40 to 105°C	*1
LQH2HPN150MGR□	15μH ±20%	1MHz	570mA	560mA(Ambient temp.85°C) 310mA(Ambient temp.105°C)	0.925Ω±20%	20MHz	-40 to 125°C	-40 to 105°C	*1
LQH2HPN220MGR□	22μH ±20%	1MHz	460mA	430mA(Ambient temp.85°C) 250mA(Ambient temp.105°C)	1.360Ω±20%	15MHz	-40 to 125°C	-40 to 105°C	*1
LQH2HPN101MGR□	100μH ±20%	1MHz	210mA	150mA(Ambient temp.85°C)	5.9Ω±20%	5MHz	-40 to 105°C	-40 to 85°C	*2

Class of Magnetic Shield: Magnetic Resin

Only for reflow soldering

*I_{sat}: Rated Current based on Inductance change

*I_{temp}: Rated Current based on Temperature rise

*S.R.F.: Self Resonant Frequency

*1: When rated current is applied to the products, inductance will be within ±30% of initial inductance value range. Keep the temperature (ambient temperature plus self-generation of heat) under 125°C. When rated current is applied to the products, the temperature rise caused by self-generated heat shall be limited to 40°C (at the rated current under 85°C) or 20°C (at the rated current under 105°C).

*2: When rated current is applied to the products, inductance will be within ±30% of initial inductance value range. Keep the temperature (ambient temperature plus self-generation of heat) under 105°C. When rated current is applied to the products, the temperature rise caused by self-generated heat shall be limited to 20°C.

Inductance-Frequency Characteristics (Typ.)

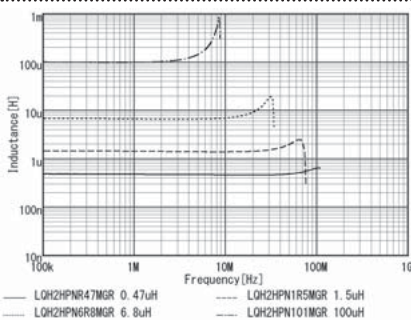

Inductance-Current Characteristics (Typ.)

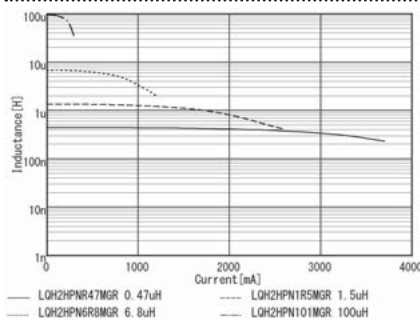

Temperature Rise Characteristics (Typ.)

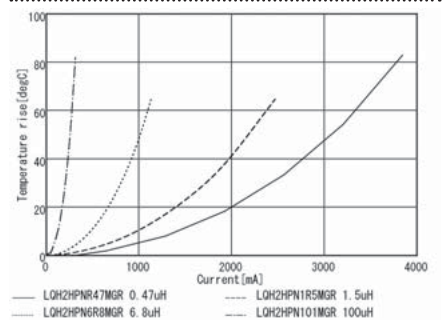

LQH2HPN_JR Series 1008 (2520) inch (mm)



Packaging Code	Packaging	Minimum Quantity
L	ø180mm Embossed Taping	2000

Part Number (□: packaging code)	Inductance	Inductance Test Frequency	Rated Current (I _{sat})*	Rated Current (I _{temp})*	DC Resistance	S.R.F.* (min.)
LQH2HPNR47NJR□	0.47μH ±30%	1MHz	3500mA	2750mA(Ambient temp.85°C) 1650mA(Ambient temp.105°C)	0.031Ω±20%	190MHz
LQH2HPN1R0NJR□	1.0μH ±30%	1MHz	2600mA	2400mA(Ambient temp.85°C) 1440mA(Ambient temp.105°C)	0.048Ω±20%	120MHz
LQH2HPN1R2NJR□	1.2μH ±30%	1MHz	2450mA	2070mA(Ambient temp.85°C) 1240mA(Ambient temp.105°C)	0.055Ω±20%	100MHz
LQH2HPN1R5NJR□	1.5μH ±30%	1MHz	2200mA	1810mA(Ambient temp.85°C) 1080mA(Ambient temp.105°C)	0.075Ω±20%	95MHz
LQH2HPN2R2MJR□	2.2μH ±20%	1MHz	1700mA	1650mA(Ambient temp.85°C) 990mA(Ambient temp.105°C)	0.092Ω±20%	50MHz
LQH2HPN3R3MJR□	3.3μH ±20%	1MHz	1450mA	1420mA(Ambient temp.85°C) 850mA(Ambient temp.105°C)	0.13Ω±20%	45MHz
LQH2HPN4R7MJR□	4.7μH ±20%	1MHz	1230mA	1290mA(Ambient temp.85°C) 770mA(Ambient temp.105°C)	0.17Ω±20%	40MHz
LQH2HPN6R8MJR□	6.8μH ±20%	1MHz	1050mA	1000mA(Ambient temp.85°C) 600mA(Ambient temp.105°C)	0.26Ω±20%	35MHz
LQH2HPN100MJR□	10μH ±20%	1MHz	830mA	830mA(Ambient temp.85°C) 490mA(Ambient temp.105°C)	0.38Ω±20%	30MHz
LQH2HPN150MJR□	15μH ±20%	1MHz	690mA	710mA(Ambient temp.85°C) 420mA(Ambient temp.105°C)	0.55Ω±20%	20MHz
LQH2HPN220MJR□	22μH ±20%	1MHz	530mA	540mA(Ambient temp.85°C) 320mA(Ambient temp.105°C)	0.84Ω±20%	20MHz

Operating temp. range (Self-temp. rise included): -40 to 125°C
 Operating temp. range (Self-temp. rise not included): -40 to 105°C
 Class of Magnetic Shield: Magnetic Resin
 Only for reflow soldering

*I_{sat}: Rated Current based on Inductance change
 *I_{temp}: Rated Current based on Temperature rise
 *S.R.F.: Self Resonant Frequency

When rated current is applied to the products, inductance will be within ±30% of initial inductance value range. Keep the temperature (ambient temperature plus self-generation of heat) under 125°C. When rated current is applied to the products, the self-temperature rise shall be limited to 40°C max. (ambient temperature 85°C). When rated current is applied to the products, the self-temperature rise shall be limited to 20°C max. (ambient temperature 85 °C to 105°C).

Inductance-Frequency Characteristics (Typ.)



Inductance-Current Characteristics (Typ.)



Temperature Rise Characteristics (Typ.)



LQH31CN_03 Series 1206 (3216) inch (mm)



Packaging Code	Packaging	Minimum Quantity
K	ø330mm Embossed Taping	7500
L	ø180mm Embossed Taping	2000

Part Number (□: packaging code)	Inductance	Inductance Test Frequency	Rated Current	DC Resistance	S.R.F.* (min.)
LQH31CNR12M03□	0.12μH ±20%	1MHz	970mA	0.08Ω±40%	250MHz
LQH31CNR22M03□	0.22μH ±20%	1MHz	850mA	0.10Ω±40%	250MHz
LQH31CNR47M03□	0.47μH ±20%	1MHz	700mA	0.15Ω±40%	180MHz
LQH31CN1R0M03□	1.0μH ±20%	1MHz	510mA	0.28Ω±30%	100MHz
LQH31CN2R2M03□	2.2μH ±20%	1MHz	430mA	0.41Ω±30%	50MHz
LQH31CN4R7M03□	4.7μH ±20%	1MHz	340mA	0.65Ω±30%	31MHz
LQH31CN100K03□	10μH ±10%	1MHz	230mA	1.3Ω±30%	20MHz
LQH31CN220K03□	22μH ±10%	1MHz	160mA	3.0Ω±30%	14MHz
LQH31CN470K03□	47μH ±10%	1MHz	100mA	8.0Ω±30%	10MHz
LQH31CN101K03□	100μH ±10%	1MHz	80mA	12.0Ω±30%	7MHz

Operating temp. range: -40 to 85°C

Class of Magnetic Shield: No Shield

*S.R.F.: Self Resonant Frequency

When rated current is applied to the products, inductance will be within ±10% of initial inductance value. When rated current is applied to the products, the temperature rise caused by self-generated heat shall be limited to 35°C max.

Inductance-Frequency Characteristics (Typ.)



Inductance-Current Characteristics (Typ.)



Impedance-Frequency Characteristics (Typ.)



LQH32CN_23 Series 1210 (3225) inch (mm)



Packaging Code	Packaging	Minimum Quantity
K	ø330mm Embossed Taping	7500
L	ø180mm Embossed Taping	2000

Continued on the following page. ↗

Continued from the preceding page. ↘

Part Number (□: packaging code)	Inductance	Inductance Test Frequency	Rated Current	DC Resistance	S.R.F.* (min.)
LQH32CN1R0M23□	1.0μH ±20%	1MHz	800mA	0.09Ω±30%	96MHz
LQH32CN2R2M23□	2.2μH ±20%	1MHz	600mA	0.13Ω±30%	64MHz
LQH32CN4R7M23□	4.7μH ±20%	1MHz	450mA	0.2Ω±30%	43MHz
LQH32CN100K23□	10μH ±10%	1MHz	300mA	0.44Ω±30%	26MHz
LQH32CN220K23□	22μH ±10%	1MHz	250mA	0.71Ω±30%	19MHz
LQH32CN470K23□	47μH ±10%	1MHz	170mA	1.3Ω±30%	15MHz
LQH32CN101K23□	100μH ±10%	1MHz	100mA	3.5Ω±30%	10MHz
LQH32CN221K23□	220μH ±10%	1MHz	70mA	8.4Ω±30%	6.8MHz
LQH32CN331K23□	330μH ±10%	1MHz	60mA	10.0Ω±30%	5.6MHz
LQH32CN391K23□	390μH ±10%	1MHz	60mA	17Ω±30%	5.0MHz
LQH32CN471K23□	470μH ±10%	1kHz	60mA	19Ω±30%	5.0MHz
LQH32CN561K23□	560μH ±10%	1kHz	60mA	22.0Ω±30%	5.0MHz

Operating temp. range: -40 to 85°C

Class of Magnetic Shield: No Shield

*S.R.F.: Self Resonant Frequency

When rated current is applied to the products, self-temperature rise shall be limited to 20°C max and inductance will be within ±10% of initial inductance value.

Inductance-Frequency Characteristics (Typ.)



Inductance-Current Characteristics (Typ.)



Impedance-Frequency Characteristics (Typ.)



LQH32CN_33 Series 1210 (3225) inch (mm)



Packaging Code	Packaging	Minimum Quantity
K	ø330mm Embossed Taping	7500
L	ø180mm Embossed Taping	2000

Part Number (□: packaging code)	Inductance	Inductance Test Frequency	Rated Current	DC Resistance	S.R.F.* (min.)
LQH32CNR15M33□	0.15μH ±20%	1MHz	1450mA	0.028Ω±30%	400MHz
LQH32CNR27M33□	0.27μH ±20%	1MHz	1250mA	0.034Ω±30%	250MHz
LQH32CNR47M33□	0.47μH ±20%	1MHz	1100mA	0.042Ω±30%	150MHz
LQH32CN1R0M33□	1.0μH ±20%	1MHz	1000mA	0.06Ω±30%	100MHz
LQH32CN2R2M33□	2.2μH ±20%	1MHz	790mA	0.097Ω±30%	64MHz
LQH32CN4R7M33□	4.7μH ±20%	1MHz	650mA	0.15Ω±30%	43MHz
LQH32CN100K33□	10μH ±10%	1MHz	450mA	0.3Ω±30%	26MHz

Operating temp. range: -40 to 85°C

Class of Magnetic Shield: No Shield

*S.R.F.: Self Resonant Frequency

When rated current is applied to the products, self-temperature rise shall be limited to 20°C max and inductance will be within ±10% of initial inductance value.

Continued on the following page. ↗

Continued from the preceding page. ↘

Inductance-Frequency Characteristics (Typ.)



Inductance-Current Characteristics (Typ.)



Impedance-Frequency Characteristics (Typ.)



LQH32CN_53 Series 1210 (3225) inch (mm)



Marking of inductance letter is available. (optional)



0.9±0.3 (in mm)

Packaging Code	Packaging	Minimum Quantity
K	ø330mm Embossed Taping	7500
L	ø180mm Embossed Taping	2000

Part Number (□: packaging code)	Inductance	Inductance Test Frequency	Rated Current	DC Resistance	S.R.F.* (min.)
LQH32CN1R0M53□	1.0μH ±20%	1MHz	1000mA	0.060Ω±30%	100MHz
LQH32CN2R2M53□	2.2μH ±20%	1MHz	790mA	0.097Ω±30%	64MHz
LQH32CN3R3M53□	3.3μH ±20%	1MHz	710mA	0.12Ω±30%	50MHz
LQH32CN4R7M53□	4.7μH ±20%	1MHz	650mA	0.15Ω±30%	43MHz
LQH32CN6R8M53□	6.8μH ±20%	1MHz	540mA	0.25Ω±30%	32MHz
LQH32CN100K53□	10μH ±10%	1MHz	450mA	0.30Ω±30%	26MHz
LQH32CN150K53□	15μH ±10%	1MHz	300mA	0.58Ω±30%	26MHz
LQH32CN220K53□	22μH ±10%	1MHz	250mA	0.71Ω±30%	19MHz
LQH32CN330K53□	33μH ±10%	1MHz	200mA	1.1Ω±30%	17MHz
LQH32CN470K53□	47μH ±10%	1MHz	170mA	1.3Ω±30%	15MHz
LQH32CN680K53□	68μH ±10%	1MHz	130mA	2.2Ω±30%	12MHz
LQH32CN101K53□	100μH ±10%	1MHz	100mA	3.5Ω±30%	10MHz

Operating temp. range: -40 to 85°C

Class of Magnetic Shield: No Shield

*S.R.F.: Self Resonant Frequency

When rated current is applied to the products, self-temperature rise shall be limited to 20°C max and inductance will be within ±10% of initial inductance value.

Inductance-Frequency Characteristics (Typ.)



Inductance-Current Characteristics (Typ.)



Impedance-Frequency Characteristics (Typ.)



Inductors for Power Lines LQH32CN_53
 Inductors for General Circuits
 RF Inductors

LQH32DN_23 Series 1210 (3225) inch (mm)



Packaging Code	Packaging	Minimum Quantity
K	ø330mm Embossed Taping	7500
L	ø180mm Embossed Taping	2000

Part Number (□: packaging code)	Inductance	Inductance Test Frequency	Rated Current	DC Resistance	S.R.F.* (min.)	Operating temp. range
LQH32DN1R0M23□	1.0μH ±20%	1MHz	800mA	0.09Ω±30%	96MHz	-40 to 105°C
LQH32DN2R2M23□	2.2μH ±20%	1MHz	600mA	0.13Ω±30%	64MHz	-40 to 105°C
LQH32DN3R3M23□	3.3μH ±20%	1MHz	530mA	0.20Ω±30%	50MHz	-40 to 105°C
LQH32DN4R7M23□	4.7μH ±20%	1MHz	450mA	0.20Ω±30%	43MHz	-40 to 105°C
LQH32DN100K23□	10μH ±10%	1MHz	300mA	0.44Ω±30%	26MHz	-40 to 105°C
LQH32DN220K23□	22μH ±10%	1MHz	250mA	0.71Ω±30%	19MHz	-40 to 105°C
LQH32DN390K23□	39μH ±10%	1MHz	200mA	1.2Ω±30%	16MHz	-40 to 105°C
LQH32DN470K23□	47μH ±10%	1MHz	170mA	1.3Ω±30%	15MHz	-40 to 105°C
LQH32DN680K23□	68μH ±10%	1MHz	130mA	2.2Ω±30%	12MHz	-40 to 105°C
LQH32DN101K23□	100μH ±10%	1MHz	100mA	3.5Ω±30%	10MHz	-40 to 105°C
LQH32DN151K23□	150μH ±10%	1MHz	80mA	5.1Ω±30%	8.0MHz	-40 to 105°C
LQH32DN221K23□	220μH ±10%	1MHz	70mA	8.4Ω±30%	6.8MHz	-40 to 105°C
LQH32DN331K23□	330μH ±10%	1MHz	60mA	10.0Ω±30%	5.6MHz	-40 to 105°C
LQH32DN391K23□	390μH ±10%	1MHz	60mA	17Ω±30%	5MHz	-40 to 85°C
LQH32DN471K23□	470μH ±10%	1kHz	60mA	19Ω±30%	5MHz	-40 to 85°C
LQH32DN561K23□	560μH ±10%	1kHz	60mA	22Ω±30%	5MHz	-40 to 85°C

Class of Magnetic Shield: No Shield

Only for reflow soldering

*S.R.F.: Self Resonant Frequency

When rated current is applied to the products, self-temperature rise shall be limited to 20°C max and inductance will be within ±10% of initial inductance value.

Inductance-Frequency Characteristics (Typ.)



Inductance-Current Characteristics (Typ.)



Impedance-Frequency Characteristics (Typ.)



LQH32DN_23

Inductors for Power Lines

Inductors for General Circuits

RF Inductors

LQH32DN_53 Series 1210 (3225) inch (mm)



Packaging Code	Packaging	Minimum Quantity
K	ø330mm Embossed Taping	7500
L	ø180mm Embossed Taping	2000

Part Number (□: packaging code)	Inductance	Inductance Test Frequency	Rated Current	DC Resistance	S.R.F.* (min.)
LQH32DN1R0M53□	1.0μH ±20%	1MHz	1000mA	0.060Ω±30%	100MHz
LQH32DN2R2M53□	2.2μH ±20%	1MHz	790mA	0.097Ω±30%	64MHz
LQH32DN3R3M53□	3.3μH ±20%	1MHz	710mA	0.12Ω±30%	50MHz
LQH32DN4R7M53□	4.7μH ±20%	1MHz	650mA	0.15Ω±30%	43MHz
LQH32DN6R8M53□	6.8μH ±20%	1MHz	540mA	0.25Ω±30%	32MHz
LQH32DN100K53□	10μH ±10%	1MHz	450mA	0.30Ω±30%	26MHz
LQH32DN150K53□	15μH ±10%	1MHz	300mA	0.58Ω±30%	26MHz
LQH32DN220K53□	22μH ±10%	1MHz	250mA	0.71Ω±30%	19MHz
LQH32DN330K53□	33μH ±10%	1MHz	200mA	1.1Ω±30%	17MHz
LQH32DN470K53□	47μH ±10%	1MHz	170mA	1.3Ω±30%	15MHz
LQH32DN680K53□	68μH ±10%	1MHz	130mA	2.2Ω±30%	12MHz
LQH32DN101K53□	100μH ±10%	1MHz	100mA	3.5Ω±30%	10MHz

Operating temp. range: -40 to 105°C
 Class of Magnetic Shield: No Shield
 Only for reflow soldering

*S.R.F.: Self Resonant Frequency

When rated current is applied to the products, self-temperature rise shall be limited to 20°C max and inductance will be within ±10% of initial inductance value.

Inductance-Frequency Characteristics (Typ.)



Inductance-Current Characteristics (Typ.)



Impedance-Frequency Characteristics (Typ.)



LQH32PB_N0 Series 1210 (3225) inch (mm)



(in mm)

Packaging Code	Packaging	Minimum Quantity
K	ø330mm Embossed Taping	7500
L	ø180mm Embossed Taping	2000
B	Packing in Bulk	500

Part Number (□: packaging code)	Inductance	Inductance Test Frequency	Rated Current (Isat)*	Rated Current (Itemp)*	DC Resistance	S.R.F.* (min.)
LQH32PBR47NNO□	0.47µH ±30%	1MHz	3400mA	2550mA(Ambient temp.85°C) 1600mA(Ambient temp.105°C)	0.030Ω±20%	100MHz
LQH32PB1R0NNO□	1.0µH ±30%	1MHz	2300mA	2050mA(Ambient temp.85°C) 1320mA(Ambient temp.105°C)	0.045Ω±20%	100MHz
LQH32PB1R5NNO□	1.5µH ±30%	1MHz	1750mA	1750mA(Ambient temp.85°C) 1010mA(Ambient temp.105°C)	0.057Ω±20%	70MHz
LQH32PB2R2NNO□	2.2µH ±30%	1MHz	1550mA	1600mA(Ambient temp.85°C) 970mA(Ambient temp.105°C)	0.076Ω±20%	70MHz
LQH32PB3R3NNO□	3.3µH ±30%	1MHz	1250mA	1200mA(Ambient temp.85°C) 670mA(Ambient temp.105°C)	0.12Ω±20%	50MHz
LQH32PB4R7NNO□	4.7µH ±30%	1MHz	1000mA	1000mA(Ambient temp.85°C) 530mA(Ambient temp.105°C)	0.18Ω±20%	40MHz
LQH32PB6R8NNO□	6.8µH ±30%	1MHz	850mA	850mA(Ambient temp.85°C) 510mA(Ambient temp.105°C)	0.24Ω±20%	40MHz
LQH32PB100MNNO□	10µH ±20%	1MHz	750mA	700mA(Ambient temp.85°C) 380mA(Ambient temp.105°C)	0.38Ω±20%	30MHz
LQH32PB150MNNO□	15µH ±20%	1MHz	600mA	520mA(Ambient temp.85°C) 320mA(Ambient temp.105°C)	0.57Ω±20%	20MHz
LQH32PB220MNNO□	22µH ±20%	1MHz	500mA	450mA(Ambient temp.85°C) 240mA(Ambient temp.105°C)	0.81Ω±20%	20MHz
LQH32PB330MNNO□	33µH ±20%	1MHz	380mA	390mA(Ambient temp.85°C) 190mA(Ambient temp.105°C)	1.15Ω±20%	13MHz
LQH32PB470MNNO□	47µH ±20%	1MHz	330mA	310mA(Ambient temp.85°C) 140mA(Ambient temp.105°C)	1.78Ω±20%	11MHz
LQH32PB680MNNO□	68µH ±20%	1MHz	280mA	275mA(Ambient temp.85°C) 120mA(Ambient temp.105°C)	2.28Ω±20%	11MHz
LQH32PB101MNNO□	100µH ±20%	1MHz	180mA	250mA(Ambient temp.85°C) 110mA(Ambient temp.105°C)	2.70Ω±20%	8MHz
LQH32PB121MNNO□	120µH ±20%	1MHz	170mA	200mA(Ambient temp.85°C) 80mA(Ambient temp.105°C)	4.38Ω±20%	8MHz

Operating temp. range (Self-temp. rise included): -40 to 125°C
 Operating temp. range (Self-temp. rise not included): -40 to 105°C
 Class of Magnetic Shield: Magnetic Resin

Only for reflow soldering

*Isat: Rated Current based on Inductance change

*Itemp: Rated Current based on Temperature rise

*S.R.F.: Self Resonant Frequency

When rated current is applied to the products, inductance will be within ±30% of nominal inductance value. When rated current is applied to the products, the temperature rise caused by self-generated heat shall be limited to 40°C max. Keep the temperature (ambient temperature plus self-generation of heat) under 125°C.

Continued on the following page. ↗

LQH32PB_N0 Inductors for Power Lines

Inductors for General Circuits

RF Inductors

Continued from the preceding page. ↘

Inductance-Frequency Characteristics (Typ.)



Inductance-Current Characteristics (Typ.)



Temperature Rise Characteristics (Typ.)



LQH32PB_NC Series 1210 (3225) inch (mm)



Packaging Code	Packaging	Minimum Quantity
K	ø330mm Embossed Taping	7500
L	ø180mm Embossed Taping	2000
B	Packing in Bulk	500

Part Number (□: packaging code)	Inductance	Inductance Test Frequency	Rated Current (Isat)*	Rated Current (Itemp)*	DC Resistance	S.R.F.* (min.)
LQH32PBR47NNC□	0.47µH ±30%	1MHz	4400mA	2900mA(Ambient temp.85°C) 1490mA(Ambient temp.105°C)	0.024Ω±20%	100MHz
LQH32PB1R0NNC□	1.0µH ±30%	1MHz	3000mA	2500mA(Ambient temp.85°C) 1380mA(Ambient temp.105°C)	0.036Ω±20%	100MHz
LQH32PB1R5NNC□	1.5µH ±30%	1MHz	2600mA	2100mA(Ambient temp.85°C) 1110mA(Ambient temp.105°C)	0.053Ω±20%	70MHz
LQH32PB2R2NNC□	2.2µH ±30%	1MHz	2000mA	1850mA(Ambient temp.85°C) 910mA(Ambient temp.105°C)	0.064Ω±20%	70MHz
LQH32PB3R3NNC□	3.3µH ±30%	1MHz	1900mA	1550mA(Ambient temp.85°C) 800mA(Ambient temp.105°C)	0.100Ω±20%	50MHz
LQH32PB4R7NNC□	4.7µH ±30%	1MHz	1600mA	1200mA(Ambient temp.85°C) 610mA(Ambient temp.105°C)	0.155Ω±20%	40MHz
LQH32PB6R8NNC□	6.8µH ±30%	1MHz	1300mA	1100mA(Ambient temp.85°C) 550mA(Ambient temp.105°C)	0.220Ω±20%	40MHz
LQH32PB100MNC□	10µH ±20%	1MHz	1000mA	900mA(Ambient temp.85°C) 450mA(Ambient temp.105°C)	0.295Ω±20%	30MHz
LQH32PB150MNC□	15µH ±20%	1MHz	800mA	700mA(Ambient temp.85°C) 330mA(Ambient temp.105°C)	0.475Ω±20%	20MHz
LQH32PB220MNC□	22µH ±20%	1MHz	650mA	550mA(Ambient temp.85°C) 270mA(Ambient temp.105°C)	0.685Ω±20%	20MHz

Operating temp. range (Self-temp. rise included): -40 to 125°C
 Operating temp. range (Self-temp. rise not included): -40 to 105°C
 Class of Magnetic Shield: Magnetic Resin

Only for reflow soldering

*Isat: Rated Current based on Inductance change

*Itemp: Rated Current based on Temperature rise

*S.R.F.: Self Resonant Frequency

When rated current is applied to the products, inductance will be within ±30% of nominal inductance value. When rated current is applied to the products, the temperature rise caused by self-generated heat shall be limited to 40°C max. Keep the temperature (ambient temperature plus self-generation of heat) under 125°C.

Continued on the following page. ↗

Continued from the preceding page. ↘

Inductance-Frequency Characteristics (Typ.)



Inductance-Current Characteristics (Typ.)



Temperature Rise Characteristics (Typ.)



LQH32PN_NO Series 1210 (3225) inch (mm)



Packaging Code	Packaging	Minimum Quantity
K	ø330mm Embossed Taping	7500
L	ø180mm Embossed Taping	2000
B	Packing in Bulk	500

Part Number (□: packaging code)	Inductance	Inductance Test Frequency	Rated Current (Isat)*	Rated Current (Itemp)*	DC Resistance	S.R.F.* (min.)
LQH32PNR47NNO□	0.47μH ±30%	1MHz	3400mA	2550mA	0.030Ω±20%	100MHz
LQH32PN1R0NNO□	1.0μH ±30%	1MHz	2300mA	2050mA	0.045Ω±20%	100MHz
LQH32PN1R5NNO□	1.5μH ±30%	1MHz	1750mA	1750mA	0.057Ω±20%	70MHz
LQH32PN2R2NNO□	2.2μH ±30%	1MHz	1550mA	1600mA	0.076Ω±20%	70MHz
LQH32PN3R3NNO□	3.3μH ±30%	1MHz	1250mA	1200mA	0.12Ω±20%	50MHz
LQH32PN4R7NNO□	4.7μH ±30%	1MHz	1000mA	1000mA	0.18Ω±20%	40MHz
LQH32PN6R8NNO□	6.8μH ±30%	1MHz	850mA	850mA	0.24Ω±20%	40MHz
LQH32PN100MN0□	10μH ±20%	1MHz	750mA	700mA	0.38Ω±20%	30MHz
LQH32PN150MN0□	15μH ±20%	1MHz	600mA	520mA	0.57Ω±20%	20MHz
LQH32PN220MN0□	22μH ±20%	1MHz	500mA	450mA	0.81Ω±20%	20MHz
LQH32PN330MN0□	33μH ±20%	1MHz	380mA	390mA	1.15Ω±20%	13MHz
LQH32PN470MN0□	47μH ±20%	1MHz	330mA	310mA	1.78Ω±20%	11MHz
LQH32PN680MN0□	68μH ±20%	1MHz	280mA	275mA	2.28Ω±20%	11MHz
LQH32PN101MN0□	100μH ±20%	1MHz	180mA	250mA	2.70Ω±20%	8MHz
LQH32PN121MN0□	120μH ±20%	1MHz	170mA	200mA	4.38Ω±20%	8MHz

Operating temp. range (Self-temp. rise included): -40 to 125°C
 Operating temp. range (Self-temp. rise not included): -40 to 85°C
 Class of Magnetic Shield: Magnetic Resin
 Only for reflow soldering
 *Isat: Rated Current based on Inductance change
 *Itemp: Rated Current based on Temperature rise
 *S.R.F.: Self Resonant Frequency

When rated current is applied to the products, inductance will be within ±30% of nominal inductance value. When rated current is applied to the products, the temperature rise caused by self-generated heat shall be limited to 40°C max. Keep the temperature (ambient temperature plus self-generation of heat) under 125°C.

Continued on the following page. ↗

LQH32PN_NO

Inductors for Power Lines

Inductors for General Circuits

RF Inductors

Continued from the preceding page. ↘

Inductance-Frequency Characteristics (Typ.)



Inductance-Current Characteristics (Typ.)



Temperature Rise Characteristics (Typ.)



LQH32PN_NC Series 1210 (3225) inch (mm)



Packaging Code	Packaging	Minimum Quantity
K	ø330mm Embossed Taping	7500
L	ø180mm Embossed Taping	2000

Part Number (□: packaging code)	Inductance	Inductance Test Frequency	Rated Current (Isat)*	Rated Current (Itemp)*	DC Resistance	S.R.F.* (min.)
LQH32PNR47NNC□	0.47μH ±30%	1MHz	4400mA	2900mA	0.024Ω±20%	100MHz
LQH32PN1R0NNC□	1.0μH ±30%	1MHz	3000mA	2500mA	0.036Ω±20%	100MHz
LQH32PN1R5NNC□	1.5μH ±30%	1MHz	2600mA	2100mA	0.053Ω±20%	70MHz
LQH32PN2R2NNC□	2.2μH ±30%	1MHz	2000mA	1850mA	0.064Ω±20%	70MHz
LQH32PN3R3NNC□	3.3μH ±30%	1MHz	1900mA	1550mA	0.100Ω±20%	50MHz
LQH32PN4R7NNC□	4.7μH ±30%	1MHz	1600mA	1200mA	0.155Ω±20%	40MHz
LQH32PN6R8NNC□	6.8μH ±30%	1MHz	1300mA	1100mA	0.220Ω±20%	40MHz
LQH32PN100MNC□	10μH ±20%	1MHz	1000mA	900mA	0.295Ω±20%	30MHz
LQH32PN150MNC□	15μH ±20%	1MHz	800mA	700mA	0.475Ω±20%	20MHz
LQH32PN220MNC□	22μH ±20%	1MHz	650mA	550mA	0.685Ω±20%	20MHz

Operating temp. range (Self-temp. rise included): -40 to 125°C
 Operating temp. range (Self-temp. rise not included): -40 to 85°C
 Class of Magnetic Shield: Magnetic Resin

Only for reflow soldering

*Isat: Rated Current based on Inductance change

*Itemp: Rated Current based on Temperature rise

*S.R.F.: Self Resonant Frequency

When rated current is applied to the products, inductance will be within ±30% of nominal inductance value. When rated current is applied to the products, the temperature rise caused by self-generated heat shall be limited to 40°C max. Keep the temperature (ambient temperature plus self-generation of heat) under 125°C.

Inductance-Frequency Characteristics (Typ.)



Inductance-Current Characteristics (Typ.)



Temperature Rise Characteristics (Typ.)

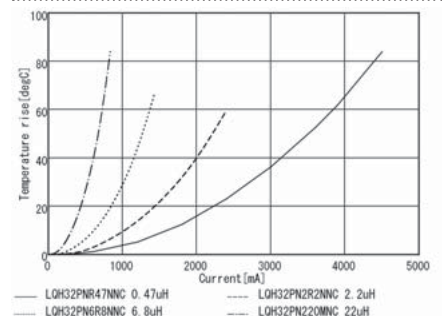

Inductors for Power Lines LQH32PN_NC
 Inductors for General Circuits
 RF Inductors

DEM2812C Series 1211 (3028) inch (mm)



Packaging Code	Packaging	Minimum Quantity
=P2	ø180mm Embossed Taping	2000

Part Number (□: packaging code)	Inductance	Inductance Test Frequency	Rated Current (Isat)*	Rated Current (Itemp)*	DC Resistance
1225AS-H-R47N□	0.47μH ±30%	0.1MHz	2500mA	3100mA	0.026Ω+20%/-30%
1225AS-H-R68N□	0.68μH ±30%	0.1MHz	2000mA	2900mA	0.031Ω+20%/-30%
1225AS-H-1R0N□	1.0μH ±30%	0.1MHz	1800mA	2700mA	0.036Ω+20%/-30%
1225AS-H-1R5N□	1.5μH ±30%	0.1MHz	1500mA	2400mA	0.043Ω+20%/-30%
1225AS-H-2R2M□	2.2μH ±20%	0.1MHz	1200mA	2000mA	0.058Ω+20%/-30%
1225AS-H-3R3M□	3.3μH ±20%	0.1MHz	1000mA	1500mA	0.080Ω+20%/-30%
1225AS-H-4R7M□	4.7μH ±20%	0.1MHz	880mA	1400mA	0.105Ω+20%/-30%
1225AS-H-6R8M□	6.8μH ±20%	0.1MHz	720mA	1100mA	0.170Ω+20%/-30%
1225AS-H-100M□	10μH ±20%	0.1MHz	580mA	850mA	0.250Ω+20%/-30%
1225AS-H-120M□	12μH ±20%	0.1MHz	550mA	760mA	0.290Ω+20%/-30%

Operating temp. range (Self-temp. rise included): -40 to 85°C

Class of Magnetic Shield: Ferrite Core

Only for reflow soldering

*Isat: Rated Current based on Inductance change

*Itemp: Rated Current based on Temperature rise

Rated current (Isat) is specified when the decrease of the initial inductance value at 30%. Rated current (Itemp) is specified when temperature of the inductor is raised 40°C by DC current.

Inductance-Current Characteristics (Typ.)



Temperature Rise Characteristics (Typ.)



DEM2815C Series 1211 (3028) inch (mm)



Packaging Code	Packaging	Minimum Quantity
=P2	ø180mm Embossed Taping	2000

Continued on the following page. ↗

Continued from the preceding page. ↘

Part Number (□: packaging code)	Inductance	Inductance Test Frequency	Rated Current (Isat)*	Rated Current (Itemp)*	DC Resistance
1226AS-H-R47N□	0.47μH ±30%	0.1MHz	2900mA	3900mA	0.020Ω+20%/-30%
1226AS-H-1R0N□	1.0μH ±30%	0.1MHz	2100mA	3300mA	0.027Ω+20%/-30%
1226AS-H-1R5N□	1.5μH ±30%	0.1MHz	1700mA	2900mA	0.031Ω+20%/-30%
1226AS-H-2R2M□	2.2μH ±20%	0.1MHz	1400mA	2200mA	0.043Ω+20%/-30%
1226AS-H-2R7M□	2.7μH ±20%	0.1MHz	1300mA	2000mA	0.053Ω+20%/-30%
1226AS-H-3R3M□	3.3μH ±20%	0.1MHz	1100mA	1900mA	0.057Ω+20%/-30%
1226AS-H-4R7M□	4.7μH ±20%	0.1MHz	950mA	1600mA	0.080Ω+20%/-30%
1226AS-H-6R8M□	6.8μH ±20%	0.1MHz	800mA	1200mA	0.130Ω+20%/-30%
1226AS-H-100M□	10μH ±20%	0.1MHz	650mA	1000mA	0.180Ω+20%/-30%
1226AS-H-120M□	12μH ±20%	0.1MHz	600mA	850mA	0.228Ω+20%/-30%
1226AS-H-150M□	15μH ±20%	0.1MHz	500mA	800mA	0.270Ω+20%/-30%

Operating temp. range (Self-temp. rise included): -40 to 85°C

Class of Magnetic Shield: Ferrite Core

Only for reflow soldering

*Isat: Rated Current based on Inductance change

*Itemp: Rated Current based on Temperature rise

Rated current (Isat) is specified when the decrease of the initial inductance value at 30%. Rated current (Itemp) is specified when temperature of the inductor is raised 40°C by DC current.

Inductance-Current Characteristics (Typ.)

Temperature Rise Characteristics (Typ.)



DEM2818C Series 1211 (3028) inch (mm)



Packaging Code	Packaging	Minimum Quantity
-P2	ø180mm Embossed Taping	2000

Part Number (□: packaging code)	Inductance	Inductance Test Frequency	Rated Current (Isat)*	Rated Current (Itemp)*	DC Resistance
1227AS-H-R47N□	0.47μH ±30%	0.1MHz	3300mA	4700mA	0.017Ω+20%/-30%
1227AS-H-1R0N□	1.0μH ±30%	0.1MHz	2300mA	3700mA	0.024Ω+20%/-30%
1227AS-H-1R5N□	1.5μH ±30%	0.1MHz	2000mA	3400mA	0.027Ω+20%/-30%
1227AS-H-2R2M□	2.2μH ±20%	0.1MHz	1700mA	2600mA	0.039Ω+20%/-30%
1227AS-H-3R3M□	3.3μH ±20%	0.1MHz	1300mA	2000mA	0.056Ω+20%/-30%
1227AS-H-4R7M□	4.7μH ±20%	0.1MHz	1100mA	1800mA	0.077Ω+20%/-30%
1227AS-H-6R8M□	6.8μH ±20%	0.1MHz	900mA	1300mA	0.122Ω+20%/-30%

Operating temp. range (Self-temp. rise included): -40 to 85°C

Class of Magnetic Shield: Ferrite Core

Only for reflow soldering

*Isat: Rated Current based on Inductance change

*Itemp: Rated Current based on Temperature rise

Rated current (Isat) is specified when the decrease of the initial inductance value at 30%. Rated current (Itemp) is specified when temperature of the inductor is raised 40°C by DC current.

Inductors for Power Lines DEM2818C
 Inductors for General Circuits
 RF Inductors

Continued from the preceding page. ↘

Part Number (□: packaging code)	Inductance	Inductance Test Frequency	Rated Current (Isat)*	Rated Current (Itemp)*	DC Resistance
1227AS-H-100M□	10μH ±20%	0.1MHz	750mA	1200mA	0.170Ω+20%/-30%
1227AS-H-120M□	12μH ±20%	0.1MHz	650mA	1000mA	0.215Ω+20%/-30%

Operating temp. range (Self-temp. rise included): -40 to 85°C

Class of Magnetic Shield: Ferrite Core

Only for reflow soldering

*Isat: Rated Current based on Inductance change

*Itemp: Rated Current based on Temperature rise

Rated current (Isat) is specified when the decrease of the initial inductance value at 30%. Rated current (Itemp) is specified when temperature of the inductor is raised 40°C by DC current.

Inductance-Current Characteristics (Typ.)



Temperature Rise Characteristics (Typ.)



LQH3NPN_GR Series 1212 (3030) inch (mm)



Packaging Code	Packaging	Minimum Quantity
K	ø330mm Embossed Taping	11000
L	ø180mm Embossed Taping	3000

Part Number (□: packaging code)	Inductance	Inductance Test Frequency	Rated Current (Isat)*	Rated Current (Itemp)*	DC Resistance	S.R.F.* (min.)	Operating temp. range (Self-temp. rise included)	Operating temp. range (Self-temp. rise not included)	Remark
LQH3NPNR47NGR□	0.47μH ±30%	1MHz	2820mA	2540mA(Ambient temp.85°C) 1520mA(Ambient temp.105°C)	0.047Ω±20%	180MHz	-40 to 125°C	-40 to 105°C	*1
LQH3NPN1R0MGR□	1.0μH ±20%	1MHz	1700mA	2080mA(Ambient temp.85°C) 1240mA(Ambient temp.105°C)	0.062Ω±20%	100MHz	-40 to 125°C	-40 to 105°C	*1
LQH3NPN1R5MGR□	1.5μH ±20%	1MHz	1400mA	2040mA(Ambient temp.85°C) 1220mA(Ambient temp.105°C)	0.074Ω±20%	80MHz	-40 to 125°C	-40 to 105°C	*1
LQH3NPN2R2MGR□	2.2μH ±20%	1MHz	1180mA	1730mA(Ambient temp.85°C) 1030mA(Ambient temp.105°C)	0.087Ω±20%	50MHz	-40 to 125°C	-40 to 105°C	*1
LQH3NPN3R3MGR□	3.3μH ±20%	1MHz	1050mA	1580mA(Ambient temp.85°C) 940mA(Ambient temp.105°C)	0.12Ω±20%	30MHz	-40 to 125°C	-40 to 105°C	*1
LQH3NPN4R7MGR□	4.7μH ±20%	1MHz	850mA	1520mA(Ambient temp.85°C) 910mA(Ambient temp.105°C)	0.14Ω±20%	27MHz	-40 to 125°C	-40 to 105°C	*1

Class of Magnetic Shield: Magnetic Resin

Only for reflow soldering

*Isat: Rated Current based on Inductance change

*Itemp: Rated Current based on Temperature rise

*S.R.F.: Self Resonant Frequency

*1: When rated current is applied to the products, inductance will be within ±30% of initial inductance value range. Keep the temperature (ambient temperature plus self-generation of heat) under 125°C. When rated current is applied to the products, the temperature rise caused by self-generated heat shall be limited to 40°C (at the rated current under 85°C) or 20°C (at the rated current under 105°C).

*2: When rated current is applied to the products, inductance will be within ±30% of initial inductance value range. Keep the temperature (ambient temperature plus self-generation of heat) under 105°C. When rated current is applied to the products, the temperature rise caused by self-generated heat shall be limited to 20°C.

Continued on the following page. ↗

Continued from the preceding page. ↘

Part Number (□: packaging code)	Inductance	Inductance Test Frequency	Rated Current (Isat)*	Rated Current (Itemp)*	DC Resistance	S.R.F.* (min.)	Operating temp. range (Self-temp. rise included)	Operating temp. range (Self-temp. rise not included)	Remark
LQH3NPN6R8MGR□	6.8μH ±20%	1MHz	720mA	1140mA(Ambient temp.85°C) 680mA(Ambient temp.105°C)	0.23Ω±20%	25MHz	-40 to 125°C	-40 to 105°C	*1
LQH3NPN100MGR□	10μH ±20%	1MHz	570mA	1120mA(Ambient temp.85°C) 670mA(Ambient temp.105°C)	0.28Ω±20%	20MHz	-40 to 125°C	-40 to 105°C	*1
LQH3NPN150MGR□	15μH ±20%	1MHz	480mA	900mA(Ambient temp.85°C) 540mA(Ambient temp.105°C)	0.39Ω±20%	15MHz	-40 to 125°C	-40 to 105°C	*1
LQH3NPN220MGR□	22μH ±20%	1MHz	390mA	750mA(Ambient temp.85°C) 450mA(Ambient temp.105°C)	0.53Ω±20%	10MHz	-40 to 125°C	-40 to 105°C	*1
LQH3NPN330MGR□	33μH ±20%	1MHz	320mA	600mA(Ambient temp.85°C) 360mA(Ambient temp.105°C)	0.86Ω±20%	8MHz	-40 to 125°C	-40 to 105°C	*1
LQH3NPN470MGR□	47μH ±20%	1MHz	260mA	460mA(Ambient temp.85°C) 270mA(Ambient temp.105°C)	1.4Ω±20%	5MHz	-40 to 125°C	-40 to 105°C	*1
LQH3NPN680MGR□	68μH ±20%	1MHz	220mA	280mA(Ambient temp.85°C)	2.1Ω±20%	6MHz	-40 to 105°C	-40 to 85°C	*2
LQH3NPN101MGR□	100μH ±20%	1MHz	190mA	220mA(Ambient temp.85°C)	3.2Ω±20%	5MHz	-40 to 105°C	-40 to 85°C	*2
LQH3NPN151MGR□	150μH ±20%	1MHz	160mA	180mA(Ambient temp.85°C)	4.9Ω±20%	3MHz	-40 to 105°C	-40 to 85°C	*2
LQH3NPN181MGR□	180μH ±20%	1MHz	130mA	160mA(Ambient temp.85°C)	6.4Ω±20%	2MHz	-40 to 105°C	-40 to 85°C	*2
LQH3NPN221MGR□	220μH ±20%	1MHz	120mA	150mA(Ambient temp.85°C)	7.5Ω±20%	2MHz	-40 to 105°C	-40 to 85°C	*2
LQH3NPN251MGR□	250μH ±20%	1MHz	110mA	140mA(Ambient temp.85°C)	8Ω±20%	2MHz	-40 to 105°C	-40 to 85°C	*2

Class of Magnetic Shield: Magnetic Resin

Only for reflow soldering

*Isat: Rated Current based on Inductance change

*Itemp: Rated Current based on Temperature rise

*S.R.F.: Self Resonant Frequency

*1: When rated current is applied to the products, inductance will be within ±30% of initial inductance value range. Keep the temperature (ambient temperature plus self-generation of heat) under 125°C. When rated current is applied to the products, the temperature rise caused by self-generated heat shall be limited to 40°C (at the rated current under 85°C) or 20°C (at the rated current under 105°C).

*2: When rated current is applied to the products, inductance will be within ±30% of initial inductance value range. Keep the temperature (ambient temperature plus self-generation of heat) under 105°C. When rated current is applied to the products, the temperature rise caused by self-generated heat shall be limited to 20°C.

Inductance-Frequency Characteristics (Typ.)



Inductance-Current Characteristics (Typ.)



Temperature Rise Characteristics (Typ.)



LQH3NPN_JR Series 1212 (3030) inch (mm)



Packaging Code	Packaging	Minimum Quantity
K	ø330mm Embossed Taping	8000
L	ø180mm Embossed Taping	2000

Continued on the following page. ↗

Continued from the preceding page. ↘

Part Number (□: packaging code)	Inductance	Inductance Test Frequency	Rated Current (Isat)*	Rated Current (Itemp)*	DC Resistance	S.R.F.* (min.)
LQH3NPNR68NJR□	0.68μH ±30%	1MHz	2700mA	2860mA(Ambient temp.85°C) 1280mA(Ambient temp.105°C)	0.032Ω±20%	130MHz
LQH3NPN1R0MJR□	1.0μH ±20%	1MHz	2250mA	2780mA(Ambient temp.85°C) 1230mA(Ambient temp.105°C)	0.040Ω±20%	100MHz
LQH3NPN1R5MJR□	1.5μH ±20%	1MHz	1950mA	2510mA(Ambient temp.85°C) 1100mA(Ambient temp.105°C)	0.049Ω±20%	60MHz
LQH3NPN2R2MJR□	2.2μH ±20%	1MHz	1800mA	2200mA(Ambient temp.85°C) 980mA(Ambient temp.105°C)	0.068Ω±20%	45MHz
LQH3NPN3R3MJR□	3.3μH ±20%	1MHz	1350mA	1700mA(Ambient temp.85°C) 750mA(Ambient temp.105°C)	0.095Ω±20%	45MHz
LQH3NPN4R7MJR□	4.7μH ±20%	1MHz	1180mA	1580mA(Ambient temp.85°C) 710mA(Ambient temp.105°C)	0.12Ω±20%	40MHz
LQH3NPN6R8MJR□	6.8μH ±20%	1MHz	970mA	1360mA(Ambient temp.85°C) 610mA(Ambient temp.105°C)	0.18Ω±20%	35MHz
LQH3NPN100MJR□	10μH ±20%	1MHz	810mA	1200mA(Ambient temp.85°C) 530mA(Ambient temp.105°C)	0.24Ω±20%	30MHz
LQH3NPN150MJR□	15μH ±20%	1MHz	650mA	870mA(Ambient temp.85°C) 370mA(Ambient temp.105°C)	0.38Ω±20%	25MHz
LQH3NPN220MJR□	22μH ±20%	1MHz	520mA	800mA(Ambient temp.85°C) 350mA(Ambient temp.105°C)	0.50Ω±20%	20MHz
LQH3NPN330MJR□	33μH ±20%	1MHz	420mA	630mA(Ambient temp.85°C) 280mA(Ambient temp.105°C)	0.79Ω±20%	15MHz
LQH3NPN470MJR□	47μH ±20%	1MHz	360mA	570mA(Ambient temp.85°C) 240mA(Ambient temp.105°C)	1.0Ω±20%	10MHz

Operating temp. range (Self-temp. rise included): -40 to 125°C

Operating temp. range (Self-temp. rise not included): -40 to 105°C

Class of Magnetic Shield: Magnetic Resin

Only for reflow soldering

*Isat: Rated Current based on Inductance change

*Itemp: Rated Current based on Temperature rise

*S.R.F.: Self Resonant Frequency

When rated current is applied to the products, inductance will be within ±30% of initial inductance value range. Keep the temperature (ambient temperature plus self-generation of heat) under 125°C. When rated current is applied to the products, the self-temperature rise shall be limited to 40°C max. (ambient temperature 85°C). When rated current is applied to the products, the self-temperature rise shall be limited to 20°C max. (ambient temperature 85°C to 105°C).

Inductance-Frequency Characteristics (Typ.)



Inductance-Current Characteristics (Typ.)



Temperature Rise Characteristics (Typ.)



LQH3NPN_JR
 Inductors for Power Lines

Inductors for General Circuits

RF Inductors

LQH3NPN_ME Series 1212 (3030) inch (mm)



Packaging Code	Packaging	Minimum Quantity
K	ø330mm Embossed Taping	8000
L	ø180mm Embossed Taping	2000
B	Packing in Bulk	100

Part Number (□: packaging code)	Inductance	Inductance Test Frequency	Rated Current (I _{sat})*	Rated Current (I _{temp})*	DC Resistance	S.R.F.* (min.)
LQH3NPN1R0MME□	1.0μH ±20%	1MHz	2350mA	3000mA(Ambient temp.85°C) 1600mA(Ambient temp.105°C)	0.025Ω±20%	100MHz
LQH3NPN2R2MME□	2.2μH ±20%	1MHz	1800mA	2100mA(Ambient temp.85°C) 1220mA(Ambient temp.105°C)	0.065Ω±20%	60MHz
LQH3NPN3R3MME□	3.3μH ±20%	1MHz	1520mA	1900mA(Ambient temp.85°C) 1150mA(Ambient temp.105°C)	0.084Ω±20%	55MHz
LQH3NPN4R7MME□	4.7μH ±20%	1MHz	1300mA	1700mA(Ambient temp.85°C) 1000mA(Ambient temp.105°C)	0.1Ω±20%	40MHz
LQH3NPN6R8MME□	6.8μH ±20%	1MHz	1040mA	1450mA(Ambient temp.85°C) 900mA(Ambient temp.105°C)	0.14Ω±20%	30MHz
LQH3NPN100MME□	10μH ±20%	1MHz	810mA	1280mA(Ambient temp.85°C) 800mA(Ambient temp.105°C)	0.19Ω±20%	20MHz
LQH3NPN150MME□	15μH ±20%	1MHz	660mA	1020mA(Ambient temp.85°C) 620mA(Ambient temp.105°C)	0.29Ω±20%	15MHz
LQH3NPN220MME□	22μH ±20%	1MHz	570mA	860mA(Ambient temp.85°C) 540mA(Ambient temp.105°C)	0.4Ω±20%	10MHz
LQH3NPN330MME□	33μH ±20%	1MHz	440mA	760mA(Ambient temp.85°C) 460mA(Ambient temp.105°C)	0.55Ω±20%	8MHz
LQH3NPN470MME□	47μH ±20%	1MHz	380mA	610mA(Ambient temp.85°C) 380mA(Ambient temp.105°C)	0.82Ω±20%	5MHz
LQH3NPN560MME□	56μH ±20%	1MHz	350mA	500mA(Ambient temp.85°C) 320mA(Ambient temp.105°C)	1Ω±20%	5MHz
LQH3NPN680MME□	68μH ±20%	1MHz	310mA	470mA(Ambient temp.85°C) 300mA(Ambient temp.105°C)	1.15Ω±20%	5MHz
LQH3NPN101MME□	100μH ±20%	1MHz	260mA	430mA(Ambient temp.85°C) 270mA(Ambient temp.105°C)	1.59Ω±20%	3MHz

Operating temp. range (Self-temp. rise included): -40 to 125°C
 Operating temp. range (Self-temp. rise not included): -40 to 105°C
 Class of Magnetic Shield: Magnetic Resin
 Only for reflow soldering

*I_{sat}: Rated Current based on Inductance change
 *I_{temp}: Rated Current based on Temperature rise
 *S.R.F.: Self Resonant Frequency

When rated current is applied to the products, inductance will be within ±30% of initial inductance value range. Keep the temperature (ambient temperature plus self-generation of heat) under 125°C. When rated current is applied to the products, the self-temperature rise shall be limited to 40°C max. (ambient temperature 85°C). When rated current is applied to the products, the self-temperature rise shall be limited to 20°C max. (ambient temperature 85°C to 105°C).

Continued on the following page. ↗

Continued from the preceding page. ↘

Inductance-Frequency Characteristics (Typ.)



Inductance-Current Characteristics (Typ.)



Temperature Rise Characteristics (Typ.)



DEM3512C Series 1514 (3735) inch (mm)



Packaging Code	Packaging	Minimum Quantity
=P3	ø330mm Embossed Taping	2000

Part Number (□: packaging code)	Inductance	Inductance Test Frequency	Rated Current (Isat)*	Rated Current (Itemp)*	DC Resistance
1229AS-H-R68N□	0.68μH ±30%	0.1MHz	2500mA	2250mA	0.043Ω+20%/-30%
1229AS-H-1R0N□	1.0μH ±30%	0.1MHz	2050mA	1850mA	0.054Ω+20%/-30%
1229AS-H-1R5N□	1.5μH ±30%	0.1MHz	1650mA	1800mA	0.062Ω+20%/-30%
1229AS-H-2R0M□	2.0μH ±20%	0.1MHz	1500mA	1700mA	0.073Ω+20%/-30%
1229AS-H-3R3M□	3.3μH ±20%	0.1MHz	1300mA	1650mA	0.080Ω+20%/-30%
1229AS-H-4R7M□	4.7μH ±20%	0.1MHz	1100mA	1350mA	0.105Ω+20%/-30%
1229AS-H-6R8M□	6.8μH ±20%	0.1MHz	900mA	1200mA	0.160Ω+20%/-30%
1229AS-H-100M□	10μH ±20%	0.1MHz	750mA	850mA	0.240Ω+20%/-30%
1229AS-H-120M□	12μH ±20%	0.1MHz	650mA	790mA	0.280Ω+20%/-30%
1229AS-H-150M□	15μH ±20%	0.1MHz	590mA	720mA	0.340Ω+20%/-30%
1229AS-H-220M□	22μH ±20%	0.1MHz	500mA	530mA	0.560Ω+20%/-30%

Operating temp. range (Self-temp. rise included): -40 to 85°C

Class of Magnetic Shield: Ferrite Core

Only for reflow soldering

*Isat: Rated Current based on Inductance change

*Itemp: Rated Current based on Temperature rise

Rated current (Isat) is specified when the decrease of the initial inductance value at 30%. Rated current (Itemp) is specified when temperature of the inductor is raised 40°C by DC current.

Inductance-Current Characteristics (Typ.)

Temperature Rise Characteristics (Typ.)

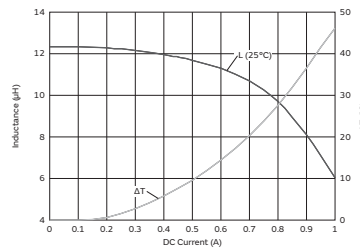
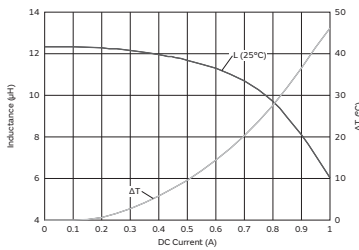

DEM3518C Series 1514 (3735) inch (mm)



Packaging Code	Packaging	Minimum Quantity
=P3	ø330mm Embossed Taping	2000

Continued on the following page. ↗

Continued from the preceding page. ↘

Part Number (□: packaging code)	Inductance	Inductance Test Frequency	Rated Current (Isat)*	Rated Current (Itemp)*	DC Resistance
1231AS-H-R56N□	0.56μH ±30%	0.1MHz	3300mA	3400mA	0.024Ω+20%/-30%
1231AS-H-1R2N□	1.2μH ±30%	0.1MHz	2400mA	2900mA	0.030Ω+20%/-30%
1231AS-H-1R5N□	1.5μH ±30%	0.1MHz	2100mA	2700mA	0.035Ω+20%/-30%
1231AS-H-2R2M□	2.2μH ±20%	0.1MHz	1900mA	2550mA	0.040Ω+20%/-30%
1231AS-H-3R3M□	3.3μH ±20%	0.1MHz	1600mA	2250mA	0.050Ω+20%/-30%
1231AS-H-4R7M□	4.7μH ±20%	0.1MHz	1350mA	2000mA	0.060Ω+20%/-30%
1231AS-H-6R4M□	6.4μH ±20%	0.1MHz	1150mA	1650mA	0.085Ω+20%/-30%
1231AS-H-100M□	10μH ±20%	0.1MHz	900mA	1250mA	0.145Ω+20%/-30%
1231AS-H-120M□	12μH ±20%	0.1MHz	850mA	1200mA	0.155Ω+20%/-30%
1231AS-H-150M□	15μH ±20%	0.1MHz	800mA	1100mA	0.185Ω+20%/-30%
1231AS-H-220M□	22μH ±20%	0.1MHz	650mA	880mA	0.285Ω+20%/-30%

Operating temp. range (Self-temp. rise included): -40 to 85°C

Class of Magnetic Shield: Ferrite Core

Only for reflow soldering

*Isat: Rated Current based on Inductance change

*Itemp: Rated Current based on Temperature rise

Rated current (Isat) is specified when the decrease of the initial inductance value at 30%. Rated current (Itemp) is specified when temperature of the inductor is raised 40°C by DC current.

Inductance-Current Characteristics (Typ.)



Temperature Rise Characteristics (Typ.)



LQH44PN_GR Series 1515 (4040) inch (mm)



(in mm)

Packaging Code	Packaging	Minimum Quantity
K	ø330mm Embossed Taping	4500
L	ø180mm Embossed Taping	1000

Part Number (□: packaging code)	Inductance	Inductance Test Frequency	Rated Current (Isat)*	Rated Current (Itemp)*	DC Resistance	S.R.F.* (min.)
LQH44PNR68NGR□	0.68μH ±30%	1MHz	2400mA	2500mA(Ambient temp.85°C) 1500mA(Ambient temp.105°C)	0.043Ω±20%	54MHz
LQH44PN2R2NGR□	2.2μH ±30%	1MHz	1600mA	2000mA(Ambient temp.85°C) 1200mA(Ambient temp.105°C)	0.074Ω±20%	45MHz

Operating temp. range (Self-temp. rise included): -40 to 125°C

Operating temp. range (Self-temp. rise not included): -40 to 105°C

Class of Magnetic Shield: Magnetic Resin

Only for reflow soldering

*Isat: Rated Current based on Inductance change

*Itemp: Rated Current based on Temperature rise

*S.R.F.: Self Resonant Frequency

When rated current is applied to the products, inductance will be within ±30% of initial inductance value range. Keep the temperature (ambient temperature plus self-generation of heat) under 125°C. When rated current is applied to the products, the self-temperature rise shall be limited to 40°C max (ambient temperature 85°C). When rated current is applied to the products, the self-temperature rise shall be limited to 20°C max (ambient temperature 85 °C to 105°C).

Continued on the following page. ↗

Continued from the preceding page. ↘

Part Number (□: packaging code)	Inductance	Inductance Test Frequency	Rated Current (Isat)*	Rated Current (Itemp)*	DC Resistance	S.R.F.* (min.)
LQH44PNR3R3NGR□	3.3μH ±30%	1MHz	1500mA	1700mA(Ambient temp.85°C) 1000mA(Ambient temp.105°C)	0.11Ω±20%	25MHz
LQH44PNR4R7MGR□	4.7μH ±20%	1MHz	1200mA	1600mA(Ambient temp.85°C) 960mA(Ambient temp.105°C)	0.13Ω±20%	17MHz
LQH44PNR6R8MGR□	6.8μH ±20%	1MHz	850mA	1400mA(Ambient temp.85°C) 840mA(Ambient temp.105°C)	0.17Ω±20%	15MHz
LQH44PN100MGR□	10μH ±20%	1MHz	800mA	1100mA(Ambient temp.85°C) 660mA(Ambient temp.105°C)	0.27Ω±20%	13MHz
LQH44PN150MGR□	15μH ±20%	1MHz	640mA	900mA(Ambient temp.85°C) 540mA(Ambient temp.105°C)	0.42Ω±20%	10MHz
LQH44PN220MGR□	22μH ±20%	1MHz	500mA	750mA(Ambient temp.85°C) 450mA(Ambient temp.105°C)	0.57Ω±20%	8MHz
LQH44PN330MGR□	33μH ±20%	1MHz	400mA	480mA(Ambient temp.85°C) 280mA(Ambient temp.105°C)	1.4Ω±20%	6MHz
LQH44PN470MGR□	47μH ±20%	1MHz	360mA	410mA(Ambient temp.85°C) 240mA(Ambient temp.105°C)	1.7Ω±20%	6MHz

Operating temp. range (Self-temp. rise included): -40 to 125°C

Operating temp. range (Self-temp. rise not included): -40 to 105°C

Class of Magnetic Shield: Magnetic Resin

Only for reflow soldering

*Isat: Rated Current based on Inductance change

*Itemp: Rated Current based on Temperature rise

*S.R.F.: Self Resonant Frequency

When rated current is applied to the products, inductance will be within ±30% of initial inductance value range. Keep the temperature (ambient temperature plus self-generation of heat) under 125°C. When rated current is applied to the products, the self-temperature rise shall be limited to 40°C max (ambient temperature 85°C). When rated current is applied to the products, the self-temperature rise shall be limited to 20°C max (ambient temperature 85 °C to 105°C).

Inductance-Frequency Characteristics (Typ.)



Inductance-Current Characteristics (Typ.)



Temperature Rise Characteristics (Typ.)



LQH44PN_J0 Series 1515 (4040) inch (mm)



Packaging Code	Packaging	Minimum Quantity
K	ø330mm Embossed Taping	4500
L	ø180mm Embossed Taping	1000

Continued on the following page. ↗

Continued from the preceding page. ↘

Part Number (□: packaging code)	Inductance	Inductance Test Frequency	Rated Current (Isat)*	Rated Current (Itemp)*	DC Resistance	S.R.F.* (min.)
LQH44PN1R0NJ0□	1.0μH ±30%	100kHz	2000mA	1530mA	0.048Ω±20%	130MHz
LQH44PN1R5MJ0□	1.5μH ±20%	100kHz	1600mA	1380mA	0.061Ω±20%	90MHz
LQH44PN2R2MJ0□	2.2μH ±20%	100kHz	1320mA	1230mA	0.074Ω±20%	68MHz
LQH44PN3R3MJ0□	3.3μH ±20%	100kHz	900mA	1000mA	0.088Ω±20%	55MHz
LQH44PN4R7MJ0□	4.7μH ±20%	100kHz	840mA	980mA	0.117Ω±20%	50MHz
LQH44PN6R8MJ0□	6.8μH ±20%	100kHz	720mA	860mA	0.143Ω±20%	38MHz
LQH44PN100MJ0□	10μH ±20%	100kHz	560mA	790mA	0.207Ω±20%	30MHz
LQH44PN150MJ0□	15μH ±20%	100kHz	430mA	610mA	0.385Ω±20%	25MHz
LQH44PN220MJ0□	22μH ±20%	100kHz	400mA	550mA	0.480Ω±20%	18MHz
LQH44PN330MJ0□	33μH ±20%	100kHz	360mA	430mA	0.740Ω±20%	15MHz
LQH44PN470MJ0□	47μH ±20%	100kHz	300mA	380mA	1.014Ω±20%	13MHz

Operating temp. range (Self-temp. rise included): -40 to 125°C
 Operating temp. range (Self-temp. rise not included): -40 to 85°C
 Class of Magnetic Shield: Magnetic Resin
 Only for reflow soldering

*Isat: Rated Current based on Inductance change
 *Itemp: Rated Current based on Temperature rise
 *S.R.F.: Self Resonant Frequency

When rated current is applied to the products, inductance will be within ±30% of nominal inductance value. When rated current is applied to the products, the temperature rise caused by self-generated heat shall be limited to 40°C max. Keep the temperature (ambient temperature plus self-generation of heat) under 125°C.

Inductance-Frequency Characteristics (Typ.)



Inductance-Current Characteristics (Typ.)

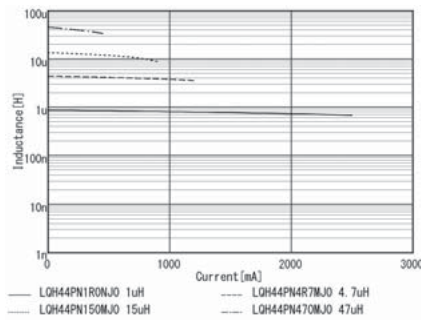

Temperature Rise Characteristics (Typ.)



LQH44PN_P0 Series 1515 (4040) inch (mm)



(in mm)

Packaging Code	Packaging	Minimum Quantity
K	ø330mm Embossed Taping	3500
L	ø180mm Embossed Taping	1000

Continued on the following page. ↗

Continued from the preceding page. ↘

Part Number (□: packaging code)	Inductance	Inductance Test Frequency	Rated Current (Isat)*	Rated Current (Itemp)*	DC Resistance	S.R.F.* (min.)
LQH44PN1R0NPO□	1.0μH ±30%	1MHz	2950mA	2450mA	0.030Ω±20%	90MHz
LQH44PN2R2MPO□	2.2μH ±20%	1MHz	2500mA	1800mA	0.049Ω±20%	70MHz
LQH44PN3R3MPO□	3.3μH ±20%	1MHz	2100mA	1770mA	0.065Ω±20%	50MHz
LQH44PN4R7MPO□	4.7μH ±20%	1MHz	1700mA	1700mA	0.080Ω±20%	40MHz
LQH44PN6R8MPO□	6.8μH ±20%	1MHz	1400mA	1340mA	0.12Ω±20%	35MHz
LQH44PN100MPO□	10μH ±20%	1MHz	1150mA	1170mA	0.16Ω±20%	25MHz
LQH44PN220MPO□	22μH ±20%	1MHz	800mA	790mA	0.37Ω±20%	17MHz

Operating temp. range (Self-temp. rise included): -40 to 125°C
 Operating temp. range (Self-temp. rise not included): -40 to 85°C
 Class of Magnetic Shield: Magnetic Resin
 Only for reflow soldering

*Isat: Rated Current based on Inductance change
 *Itemp: Rated Current based on Temperature rise
 *S.R.F.: Self Resonant Frequency

When rated current is applied to the products, inductance will be within ±30% of nominal inductance value. When rated current is applied to the products, the temperature rise caused by self-generated heat shall be limited to 40°C max. Keep the temperature (ambient temperature plus self-generation of heat) under 125°C.

Inductance-Frequency Characteristics (Typ.)



Inductance-Current Characteristics (Typ.)



Temperature Rise Characteristics (Typ.)



LQH43CN_03 Series 1812 (4532) inch (mm)



Packaging Code	Packaging	Minimum Quantity
L	ø180mm Embossed Taping	500

Part Number (□: packaging code)	Inductance	Inductance Test Frequency	Rated Current	Max. of DC Resistance	S.R.F.* (min.)
LQH43CN1R0M03□	1.0μH ±20%	1MHz	1080mA	0.08Ω	100MHz
LQH43CN1R5M03□	1.5μH ±20%	1MHz	1000mA	0.09Ω	85MHz
LQH43CN2R2M03□	2.2μH ±20%	1MHz	900mA	0.11Ω	60MHz
LQH43CN3R3M03□	3.3μH ±20%	1MHz	800mA	0.13Ω	47MHz
LQH43CN4R7M03□	4.7μH ±20%	1MHz	750mA	0.15Ω	35MHz
LQH43CN6R8M03□	6.8μH ±20%	1MHz	720mA	0.20Ω	30MHz
LQH43CN100K03□	10μH ±10%	1MHz	650mA	0.24Ω	23MHz
LQH43CN150K03□	15μH ±10%	1MHz	570mA	0.32Ω	20MHz

Operating temp. range: -40 to 85°C
 Class of Magnetic Shield: No Shield
 *S.R.F.: Self Resonant Frequency

When rated current is applied to the products, self-temperature rise shall be limited to 20°C max and inductance will be within ±10% of initial inductance value.

Continued on the following page. ↗

Continued from the preceding page. ↘

Part Number (□: packaging code)	Inductance	Inductance Test Frequency	Rated Current	Max. of DC Resistance	S.R.F.* (min.)
LQH43CN220K03□	22μH ±10%	1MHz	420mA	0.6Ω	15MHz
LQH43CN330K03□	33μH ±10%	1MHz	310mA	1.0Ω	12MHz
LQH43CN470K03□	47μH ±10%	1MHz	280mA	1.1Ω	10MHz
LQH43CN680K03□	68μH ±10%	1MHz	220mA	1.7Ω	8.4MHz
LQH43CN101K03□	100μH ±10%	1MHz	190mA	2.2Ω	6.8MHz
LQH43CN151K03□	150μH ±10%	1MHz	130mA	3.5Ω	5.5MHz
LQH43CN221K03□	220μH ±10%	1MHz	110mA	4.0Ω	4.5MHz
LQH43CN331K03□	330μH ±10%	1MHz	100mA	6.8Ω	3.6MHz
LQH43CN471K03□	470μH ±10%	1kHz	90mA	8.5Ω	3.0MHz

Operating temp. range: -40 to 85°C

Class of Magnetic Shield: No Shield

*S.R.F.: Self Resonant Frequency

When rated current is applied to the products, self-temperature rise shall be limited to 20°C max and inductance will be within ±10% of initial inductance value.

Inductance-Frequency Characteristics (Typ.)



Inductance-Current Characteristics (Typ.)



Impedance-Frequency Characteristics (Typ.)



LQH43CN_33 Series 1812 (4532) inch (mm)



Packaging Code	Packaging	Minimum Quantity
L	ø180mm Embossed Taping	500

Part Number (□: packaging code)	Inductance	Inductance Test Frequency	Rated Current	DC Resistance	S.R.F.* (min.)
LQH43CNR56M33□	0.56μH ±20%	1MHz	2950mA	0.023Ω±30%	160MHz
LQH43CNR82M33□	0.82μH ±20%	1MHz	2800mA	0.027Ω±30%	130MHz
LQH43CN1R0M33□	1.0μH ±20%	1MHz	2600mA	0.032Ω±30%	110MHz
LQH43CN1R5M33□	1.5μH ±20%	1MHz	2450mA	0.036Ω±30%	80MHz
LQH43CN1R8M33□	1.8μH ±20%	1MHz	2300mA	0.042Ω±30%	70MHz
LQH43CN2R2M33□	2.2μH ±20%	1MHz	2100mA	0.047Ω±30%	60MHz
LQH43CN2R7M33□	2.7μH ±20%	1MHz	1800mA	0.053Ω±30%	50MHz
LQH43CN3R3M33□	3.3μH ±20%	1MHz	1650mA	0.076Ω±30%	47MHz
LQH43CN3R9M33□	3.9μH ±20%	1MHz	1600mA	0.082Ω±30%	40MHz

Operating temp. range: -40 to 85°C

Class of Magnetic Shield: No Shield

*S.R.F.: Self Resonant Frequency

When rated current is applied to the products, inductance will be within ±20% of initial inductance value. When rated current is applied to the products, the temperature rise caused by self-generated heat shall be limited to 40°C max.

Continued on the following page. ↗

Continued from the preceding page. ↘

Inductance-Frequency Characteristics (Typ.)



Inductance-Current Characteristics (Typ.)



Impedance-Frequency Characteristics (Typ.)



LQH43PB_26 Series 1812 (4532) inch (mm)



Packaging Code	Packaging	Minimum Quantity
K	ø330mm Embossed Taping	2500
L	ø180mm Embossed Taping	500

Part Number (□: packaging code)	Inductance	Inductance Test Frequency	Rated Current (I _{sat})*	Rated Current (I _{temp})*	DC Resistance	S.R.F.* (min.)
LQH43PB1R0N26□	1.0μH ±30%	1MHz	3400mA	3300mA(Ambient temp.85°C) 1410mA(Ambient temp.105°C)	0.026Ω±20%	100MHz
LQH43PB2R2M26□	2.2μH ±20%	1MHz	2300mA	2500mA(Ambient temp.85°C) 1120mA(Ambient temp.105°C)	0.042Ω±20%	45MHz
LQH43PB3R3M26□	3.3μH ±20%	1MHz	1800mA	2100mA(Ambient temp.85°C) 1000mA(Ambient temp.105°C)	0.052Ω±20%	40MHz
LQH43PB4R7M26□	4.7μH ±20%	1MHz	1400mA	1600mA(Ambient temp.85°C) 780mA(Ambient temp.105°C)	0.075Ω±20%	35MHz
LQH43PB6R8M26□	6.8μH ±20%	1MHz	1200mA	1400mA(Ambient temp.85°C) 760mA(Ambient temp.105°C)	0.098Ω±20%	30MHz
LQH43PB8R2M26□	8.2μH ±20%	1MHz	1100mA	1300mA(Ambient temp.85°C) 670mA(Ambient temp.105°C)	0.128Ω±20%	25MHz
LQH43PB100M26□	10μH ±20%	1MHz	1050mA	1170mA(Ambient temp.85°C) 620mA(Ambient temp.105°C)	0.147Ω±20%	20MHz
LQH43PB220M26□	22μH ±20%	1MHz	700mA	780mA(Ambient temp.85°C) 400mA(Ambient temp.105°C)	0.327Ω±20%	15MHz
LQH43PB470M26□	47μH ±20%	1MHz	470mA	520mA(Ambient temp.85°C) 280mA(Ambient temp.105°C)	0.718Ω±20%	8MHz
LQH43PB101M26□	100μH ±20%	1MHz	320mA	320mA(Ambient temp.85°C) 180mA(Ambient temp.105°C)	1.538Ω±20%	4MHz

Operating temp. range (Self-temp. rise included): -40 to 125°C
 Operating temp. range (Self-temp. rise not included): -40 to 105°C
 Class of Magnetic Shield: Magnetic Resin

Only for reflow soldering

*I_{sat}: Rated Current based on Inductance change

*I_{temp}: Rated Current based on Temperature rise

*S.R.F.: Self Resonant Frequency

When rated current is applied to the products, inductance will be within ±30% of nominal inductance value. When rated current is applied to the products, the temperature rise caused by self-generated heat shall be limited to 40°C max. Keep the temperature (ambient temperature plus self-generation of heat) under 125°C.

Continued on the following page. ↗

Continued from the preceding page. ↘

Part Number (□: packaging code)	Inductance	Inductance Test Frequency	Rated Current (I _{sat})*	Rated Current (I _{temp})*	DC Resistance	S.R.F.* (min.)
LQH43PB151M26□	150μH ±20%	1MHz	280mA	260mA(Ambient temp.85°C) 140mA(Ambient temp.105°C)	2.362Ω±20%	3MHz
LQH43PB221M26□	220μH ±20%	1MHz	220mA	240mA(Ambient temp.85°C) 130mA(Ambient temp.105°C)	2.900Ω±20%	2MHz

Operating temp. range (Self-temp. rise included): -40 to 125°C
 Operating temp. range (Self-temp. rise not included): -40 to 105°C
 Class of Magnetic Shield: Magnetic Resin

Only for reflow soldering

*I_{sat}: Rated Current based on Inductance change

*I_{temp}: Rated Current based on Temperature rise

*S.R.F.: Self Resonant Frequency

When rated current is applied to the products, inductance will be within ±30% of nominal inductance value. When rated current is applied to the products, the temperature rise caused by self-generated heat shall be limited to 40°C max. Keep the temperature (ambient temperature plus self-generation of heat) under 125°C.

Inductance-Frequency Characteristics (Typ.)



Inductance-Current Characteristics (Typ.)



Temperature Rise Characteristics (Typ.)



LQH43PN_26 Series 1812 (4532) inch (mm)



Packaging Code	Packaging	Minimum Quantity
K	ø330mm Embossed Taping	2500
L	ø180mm Embossed Taping	500

Part Number (□: packaging code)	Inductance	Inductance Test Frequency	Rated Current (I _{sat})*	Rated Current (I _{temp})*	DC Resistance	S.R.F.* (min.)
LQH43PN1R0N26□	1.0μH ±30%	1MHz	3400mA	3300mA	0.026Ω±20%	100MHz
LQH43PN2R2M26□	2.2μH ±20%	1MHz	2300mA	2500mA	0.042Ω±20%	45MHz
LQH43PN3R3M26□	3.3μH ±20%	1MHz	1800mA	2100mA	0.052Ω±20%	40MHz
LQH43PN4R7M26□	4.7μH ±20%	1MHz	1400mA	1600mA	0.075Ω±20%	35MHz
LQH43PN6R8M26□	6.8μH ±20%	1MHz	1200mA	1400mA	0.098Ω±20%	30MHz
LQH43PN8R2M26□	8.2μH ±20%	1MHz	1100mA	1300mA	0.128Ω±20%	25MHz
LQH43PN100M26□	10μH ±20%	1MHz	1050mA	1170mA	0.147Ω±20%	20MHz
LQH43PN220M26□	22μH ±20%	1MHz	700mA	780mA	0.327Ω±20%	15MHz
LQH43PN470M26□	47μH ±20%	1MHz	470mA	520mA	0.718Ω±20%	8MHz

Operating temp. range: -40 to 85°C
 Class of Magnetic Shield: Magnetic Resin

*I_{sat}: Rated Current based on Inductance change

*I_{temp}: Rated Current based on Temperature rise

*S.R.F.: Self Resonant Frequency

When rated current is applied to the products, inductance will be within ±30% of nominal inductance value. When rated current is applied to the products, the temperature rise caused by self-generated heat shall be limited to 40°C max. Keep the temperature (ambient temperature plus self-generation of heat) under 125°C.

Continued on the following page. ↗

Continued from the preceding page. ↘

Part Number (□: packaging code)	Inductance	Inductance Test Frequency	Rated Current (Isat)*	Rated Current (Itemp)*	DC Resistance	S.R.F.* (min.)
LQH43PN101M26□	100μH ±20%	1MHz	320mA	320mA	1.538Ω±20%	4MHz
LQH43PN151M26□	150μH ±20%	1MHz	280mA	260mA	2.362Ω±20%	3MHz
LQH43PN221M26□	220μH ±20%	1MHz	220mA	240mA	2.900Ω±20%	2MHz

Operating temp. range: -40 to 85°C

Class of Magnetic Shield: Magnetic Resin

*Isat: Rated Current based on Inductance change

*Itemp: Rated Current based on Temperature rise

*S.R.F.: Self Resonant Frequency

When rated current is applied to the products, inductance will be within ±30% of nominal inductance value. When rated current is applied to the products, the temperature rise caused by self-generated heat shall be limited to 40°C max. Keep the temperature (ambient temperature plus self-generation of heat) under 125°C.

Inductance-Frequency Characteristics (Typ.)



Inductance-Current Characteristics (Typ.)



Temperature Rise Characteristics (Typ.)



DEM4518C Series 1818 (4745) inch (mm)



Packaging Code	Packaging	Minimum Quantity
=P3	ø330mm Embossed Taping	2000

Part Number (□: packaging code)	Inductance	Inductance Test Frequency	Rated Current (Isat)*	Rated Current (Itemp)*	DC Resistance
1235AS-H-1R2N□	1.2μH ±30%	0.1MHz	3500mA	2900mA	0.039Ω+20%/-30%
1235AS-H-1R8N□	1.8μH ±30%	0.1MHz	3000mA	2700mA	0.047Ω+20%/-30%
1235AS-H-2R4M□	2.4μH ±20%	0.1MHz	2600mA	2300mA	0.054Ω+20%/-30%
1235AS-H-3R3M□	3.3μH ±20%	0.1MHz	2300mA	2100mA	0.062Ω+20%/-30%
1235AS-H-4R3M□	4.3μH ±20%	0.1MHz	2000mA	2000mA	0.070Ω+20%/-30%
1235AS-H-6R8M□	6.8μH ±20%	0.1MHz	1700mA	1900mA	0.088Ω+20%/-30%
1235AS-H-100M□	10μH ±20%	0.1MHz	1300mA	1700mA	0.110Ω+20%/-30%
1235AS-H-150M□	15μH ±20%	0.1MHz	980mA	1100mA	0.160Ω+20%/-30%
1235AS-H-220M□	22μH ±20%	0.1MHz	910mA	1000mA	0.265Ω+20%/-30%

Operating temp. range (Self-temp. rise included): -40 to 85°C

Class of Magnetic Shield: Ferrite Core

Only for reflow soldering

*Isat: Rated Current based on Inductance change

*Itemp: Rated Current based on Temperature rise

Rated current (Isat) is specified when the decrease of the initial inductance value at 30%. Rated current (Itemp) is specified when temperature of the inductor is raised 40°C by DC current.

Continued on the following page. ↗

Inductors for Power Lines DEM4518C
 Inductors for General Circuits
 RF Inductors

Continued from the preceding page. ↘

Inductance-Current Characteristics (Typ.)



Temperature Rise Characteristics (Typ.)



LQH5BPB_T0 Series 2020 (5050) inch (mm)



Packaging Code	Packaging	Minimum Quantity
K	ø330mm Embossed Taping	3000
L	ø180mm Embossed Taping	500

Part Number (□: packaging code)	Inductance	Inductance Test Frequency	Rated Current (Isat)*	Rated Current (Itemp)*	DC Resistance	S.R.F.* (min.)
LQH5BPBR47NT0□	0.47µH ±30%	100kHz	7.7A	4.0A(Ambient temp.85°C) 2.05A(Ambient temp.105°C)	0.012Ω±20%	220MHz
LQH5BPB1R0NT0□	1.0µH ±30%	100kHz	5.8A	3.1A(Ambient temp.85°C) 1.68A(Ambient temp.105°C)	0.019Ω±20%	90MHz
LQH5BPB1R2NT0□	1.2µH ±30%	100kHz	5.4A	3.1A(Ambient temp.85°C) 1.68A(Ambient temp.105°C)	0.019Ω±20%	90MHz
LQH5BPB1R5NT0□	1.5µH ±30%	100kHz	5.0A	3.0A(Ambient temp.85°C) 1.63A(Ambient temp.105°C)	0.024Ω±20%	70MHz
LQH5BPB2R2NT0□	2.2µH ±30%	100kHz	4.0A	2.6A(Ambient temp.85°C) 1.37A(Ambient temp.105°C)	0.030Ω±20%	55MHz
LQH5BPB2R7NT0□	2.7µH ±30%	100kHz	3.8A	2.5A(Ambient temp.85°C) 1.23A(Ambient temp.105°C)	0.035Ω±20%	50MHz
LQH5BPB3R3NT0□	3.3µH ±30%	100kHz	3.5A	2.3A(Ambient temp.85°C) 1.21A(Ambient temp.105°C)	0.044Ω±20%	40MHz
LQH5BPB4R7NT0□	4.7µH ±30%	100kHz	3.0A	2.0A(Ambient temp.85°C) 1.09A(Ambient temp.105°C)	0.058Ω±20%	40MHz
LQH5BPB6R8NT0□	6.8µH ±30%	100kHz	2.5A	1.65A(Ambient temp.85°C) 0.96A(Ambient temp.105°C)	0.083Ω±20%	30MHz
LQH5BPB100MT0□	10µH ±20%	100kHz	2.0A	1.60A(Ambient temp.85°C) 0.87A(Ambient temp.105°C)	0.106Ω±20%	25MHz
LQH5BPB150MT0□	15µH ±20%	100kHz	1.6A	1.20A(Ambient temp.85°C) 0.62A(Ambient temp.105°C)	0.187Ω±20%	18MHz

Operating temp. range (Self-temp. rise included): -40 to 125°C
 Operating temp. range (Self-temp. rise not included): -40 to 105°C
 Class of Magnetic Shield: Magnetic Resin
 Only for reflow soldering

*Isat: Rated Current based on Inductance change
 *Itemp: Rated Current based on Temperature rise
 *S.R.F.: Self Resonant Frequency

When rated current is applied to the products, inductance will be within ±30% of nominal inductance value. When rated current is applied to the products, the temperature rise caused by self-generated heat shall be limited to 40°C max. Keep the temperature (ambient temperature plus self-generation of heat) under 125°C.

Continued on the following page. ↗

Continued from the preceding page. ↘

Part Number (□: packaging code)	Inductance	Inductance Test Frequency	Rated Current (Isat)*	Rated Current (Itemp)*	DC Resistance	S.R.F.* (min.)
LQH5BPB220MT0□	22μH ±20%	100kHz	1.4A	1.05A(Ambient temp.85°C) 0.55A(Ambient temp.105°C)	0.259Ω±20%	15MHz

Operating temp. range (Self-temp. rise included): -40 to 125°C
 Operating temp. range (Self-temp. rise not included): -40 to 105°C
 Class of Magnetic Shield: Magnetic Resin

Only for reflow soldering

*Isat: Rated Current based on Inductance change

*Itemp: Rated Current based on Temperature rise

*S.R.F.: Self Resonant Frequency

When rated current is applied to the products, inductance will be within ±30% of nominal inductance value. When rated current is applied to the products, the temperature rise caused by self-generated heat shall be limited to 40°C max. Keep the temperature (ambient temperature plus self-generation of heat) under 125°C.

Inductance-Frequency Characteristics (Typ.)



Inductance-Current Characteristics (Typ.)



Temperature Rise Characteristics (Typ.)



LQH5BPN_38 Series 2020 (5050) inch (mm)



(in mm)

Packaging Code	Packaging	Minimum Quantity
K	ø330mm Embossed Taping	1500
L	ø180mm Embossed Taping	400

Part Number (□: packaging code)	Inductance	Inductance Test Frequency	Rated Current (Isat)*	Rated Current (Itemp)*	DC Resistance	S.R.F.* (min.)
LQH5BPN1R0N38□	1.0μH ±30%	100kHz	7000mA	4600mA	0.012Ω±20%	54MHz
LQH5BPN1R5N38□	1.5μH ±30%	100kHz	6500mA	4500mA	0.014Ω±20%	50MHz
LQH5BPN2R2N38□	2.2μH ±30%	100kHz	5000mA	4300mA	0.016Ω±20%	45MHz
LQH5BPN3R3N38□	3.3μH ±30%	100kHz	4000mA	4000mA	0.021Ω±20%	25MHz
LQH5BPN4R7N38□	4.7μH ±30%	100kHz	3500mA	3800mA	0.026Ω±20%	17MHz
LQH5BPN6R8M38□	6.8μH ±20%	100kHz	3000mA	3000mA	0.039Ω±20%	15MHz
LQH5BPN100M38□	10μH ±20%	100kHz	2600mA	2200mA	0.056Ω±20%	13MHz
LQH5BPN150M38□	15μH ±20%	100kHz	1800mA	1900mA	0.08Ω±20%	10MHz
LQH5BPN220M38□	22μH ±20%	100kHz	1600mA	1500mA	0.11Ω±20%	8.0MHz

Operating temp. range (Self-temp. rise included): -40 to 125°C
 Operating temp. range (Self-temp. rise not included): -40 to 85°C
 Class of Magnetic Shield: Magnetic Resin

Only for reflow soldering

*Isat: Rated Current based on Inductance change

*Itemp: Rated Current based on Temperature rise

*S.R.F.: Self Resonant Frequency

When rated current is applied to the products, inductance will be within ±30% of initial inductance value range. When rated current is applied to the products, the temperature rise caused by self-generated heat shall be limited to 40°C max. (ambient temperature 85°C). Keep the temperature (ambient temperature plus self-generation of heat) under 125°C.

Continued on the following page. ↗

Continued from the preceding page. ↘

Part Number (□: packaging code)	Inductance	Inductance Test Frequency	Rated Current (Isat)*	Rated Current (Itemp)*	DC Resistance	S.R.F.* (min.)
LQH5BPN330M38□	33μH ±20%	100kHz	1300mA	1300mA	0.15Ω±20%	6.5MHz
LQH5BPN470M38□	47μH ±20%	100kHz	1100mA	1100mA	0.22Ω±20%	6.0MHz
LQH5BPN680M38□	68μH ±20%	100kHz	900mA	930mA	0.33Ω±20%	5.0MHz
LQH5BPN101M38□	100μH ±20%	100kHz	750mA	740mA	0.48Ω±20%	4.0MHz
LQH5BPN151M38□	150μH ±20%	100kHz	650mA	630mA	0.68Ω±20%	3.5MHz

Operating temp. range (Self-temp. rise included): -40 to 125°C
 Operating temp. range (Self-temp. rise not included): -40 to 85°C
 Class of Magnetic Shield: Magnetic Resin
 Only for reflow soldering

*Isat: Rated Current based on Inductance change
 *Itemp: Rated Current based on Temperature rise
 *S.R.F.: Self Resonant Frequency

When rated current is applied to the products, inductance will be within ±30% of initial inductance value range. When rated current is applied to the products, the temperature rise caused by self-generated heat shall be limited to 40°C max. (ambient temperature 85°C). Keep the temperature (ambient temperature plus self-generation of heat) under 125°C.

Inductance-Frequency Characteristics (Typ.)



Inductance-Current Characteristics (Typ.)



Temperature Rise Characteristics (Typ.)



LQH5BPN_T0 Series 2020 (5050) inch (mm)



Packaging Code	Packaging	Minimum Quantity
K	ø330mm Embossed Taping	3000
L	ø180mm Embossed Taping	500

Part Number (□: packaging code)	Inductance	Inductance Test Frequency	Rated Current (Isat)*	Rated Current (Itemp)*	DC Resistance	S.R.F.* (min.)
LQH5BPNR47NT0□	0.47μH ±30%	100kHz	7.7A	4.0A	0.012Ω±20%	220MHz
LQH5BPN1R0NT0□	1.0μH ±30%	100kHz	5.8A	3.1A	0.019Ω±20%	90MHz
LQH5BPN1R2NT0□	1.2μH ±30%	100kHz	5.4A	3.1A	0.019Ω±20%	90MHz
LQH5BPN1R5NT0□	1.5μH ±30%	100kHz	5.0A	3.0A	0.024Ω±20%	70MHz
LQH5BPN2R2NT0□	2.2μH ±30%	100kHz	4.0A	2.6A	0.030Ω±20%	55MHz
LQH5BPN2R7NT0□	2.7μH ±30%	100kHz	3.8A	2.5A	0.035Ω±20%	50MHz

Operating temp. range (Self-temp. rise included): -40 to 125°C
 Operating temp. range (Self-temp. rise not included): -40 to 85°C
 Class of Magnetic Shield: Magnetic Resin
 Only for reflow soldering

*Isat: Rated Current based on Inductance change
 *Itemp: Rated Current based on Temperature rise
 *S.R.F.: Self Resonant Frequency

When rated current is applied to the products, inductance will be within ±30% of nominal inductance value. When rated current is applied to the products, the temperature rise caused by self-generated heat shall be limited to 40°C max. Keep the temperature (ambient temperature plus self-generation of heat) under 125°C.

Continued on the following page. ↗

Continued from the preceding page. ↘

Part Number (□: packaging code)	Inductance	Inductance Test Frequency	Rated Current (Isat)*	Rated Current (Itemp)*	DC Resistance	S.R.F.* (min.)
LQH5BPN3R3NTO□	3.3μH ±30%	100kHz	3.5A	2.3A	0.044Ω±20%	40MHz
LQH5BPN4R7NTO□	4.7μH ±30%	100kHz	3.0A	2.0A	0.058Ω±20%	40MHz
LQH5BPN6R8NTO□	6.8μH ±30%	100kHz	2.5A	1.65A	0.083Ω±20%	30MHz
LQH5BPN100MTO□	10μH ±20%	100kHz	2.0A	1.60A	0.106Ω±20%	25MHz
LQH5BPN150MTO□	15μH ±20%	100kHz	1.6A	1.20A	0.187Ω±20%	18MHz
LQH5BPN220MTO□	22μH ±20%	100kHz	1.4A	1.05A	0.259Ω±20%	15MHz

Operating temp. range (Self-temp. rise included): -40 to 125°C
 Operating temp. range (Self-temp. rise not included): -40 to 85°C
 Class of Magnetic Shield: Magnetic Resin

Only for reflow soldering

*Isat: Rated Current based on Inductance change

*Itemp: Rated Current based on Temperature rise

*S.R.F.: Self Resonant Frequency

When rated current is applied to the products, inductance will be within ±30% of nominal inductance value. When rated current is applied to the products, the temperature rise caused by self-generated heat shall be limited to 40°C max. Keep the temperature (ambient temperature plus self-generation of heat) under 125°C.

Inductance-Frequency Characteristics (Typ.)



Inductance-Current Characteristics (Typ.)



Temperature Rise Characteristics (Typ.)



D52LC Series 2020 (5252) inch (mm)



Packaging Code	Packaging	Minimum Quantity
=P3	ø330mm Embossed Taping	2000

Part Number (□: packaging code)	Inductance	Inductance Test Frequency	Rated Current (Isat)*	Rated Current (Itemp)*	Max. of DC Resistance
#A914BYW-1R2M□	1.2μH ±20%	0.1MHz	2150mA	2440mA	0.044Ω
#A914BYW-2R2M□	2.2μH ±20%	0.1MHz	1630mA	1740mA	0.059Ω
#A914BYW-3R5M□	3.5μH ±20%	0.1MHz	1340mA	1540mA	0.073Ω
#A914BYW-4R7M□	4.7μH ±20%	0.1MHz	1140mA	1300mA	0.087Ω
#A914BYW-6R8M□	6.8μH ±20%	0.1MHz	950mA	1170mA	0.105Ω
#A914BYW-100M□	10μH ±20%	0.1MHz	760mA	930mA	0.150Ω
#A914BYW-150M□	15μH ±20%	0.1MHz	630mA	770mA	0.210Ω
#A914BYW-220M□	22μH ±20%	0.1MHz	560mA	700mA	0.275Ω

Operating temp. range (Self-temp. rise included): -40 to 85°C
 Class of Magnetic Shield: Ferrite Core

Only for reflow soldering

*Isat: Rated Current based on Inductance change

*Itemp: Rated Current based on Temperature rise

Rated current (Isat) is specified when the decrease of the initial inductance value at 30%. Rated current (Itemp) is specified when temperature of the inductor is raised 40°C by DC current.

Continued on the following page. ↗

Continued from the preceding page. ↘

Part Number (□: packaging code)	Inductance	Inductance Test Frequency	Rated Current (Isat)*	Rated Current (Itemp)*	Max. of DC Resistance
#A914BYW-330M□	33μH ±20%	0.1MHz	440mA	510mA	0.455Ω
#A914BYW-470M□	47μH ±20%	0.1MHz	360mA	380mA	0.730Ω
#A914BYW-560M□	56μH ±20%	0.1MHz	330mA	370mA	0.828Ω
#A914BYW-680M□	68μH ±20%	0.1MHz	300mA	350mA	0.935Ω
#A914BY-101M□	100μH ±20%	0.1MHz	230mA	260mA	1.500Ω

Operating temp. range (Self-temp. rise included): -40 to 85°C

Class of Magnetic Shield: Ferrite Core

Only for reflow soldering

*Isat: Rated Current based on Inductance change

*Itemp: Rated Current based on Temperature rise

Rated current (Isat) is specified when the decrease of the initial inductance value at 30%. Rated current (Itemp) is specified when temperature of the inductor is raised 40°C by DC current.

Inductance-Current Characteristics (Typ.)



Temperature Rise Characteristics (Typ.)



D53LC High Current Series 2020 (5252) inch (mm)



Packaging Code	Packaging	Minimum Quantity
=P3	ø330mm Embossed Taping	2000

Part Number (□: packaging code)	Inductance	Inductance Test Frequency	Rated Current (Isat)*	Rated Current (Itemp)*	DC Resistance
#A915AY-1R1M□	1.1μH ±20%	0.1MHz	3870mA	3250mA	0.016Ω+20%/-30%
#A915AY-2R0M□	2.0μH ±20%	0.1MHz	2920mA	2640mA	0.022Ω+20%/-30%
#A915AY-3R3M□	3.3μH ±20%	0.1MHz	2360mA	2260mA	0.029Ω+20%/-30%
#A915AY-4R7M□	4.7μH ±20%	0.1MHz	1870mA	2010mA	0.038Ω+20%/-30%
#A915AY-6R8M□	6.8μH ±20%	0.1MHz	1510mA	1650mA	0.057Ω+20%/-30%
#A915AY-100M□	10μH ±20%	0.1MHz	1330mA	1410mA	0.075Ω+20%/-30%
#A915AY-150M□	15μH ±20%	0.1MHz	1050mA	1100mA	0.118Ω+20%/-30%
#A915AY-220M□	22μH ±20%	0.1MHz	860mA	810mA	0.173Ω+20%/-30%
#A915AY-330M□	33μH ±20%	0.1MHz	720mA	750mA	0.214Ω+20%/-30%
#A915AY-470M□	47μH ±20%	0.1MHz	620mA	640mA	0.293Ω+20%/-30%
#A915AY-680M□	68μH ±20%	0.1MHz	510mA	520mA	0.437Ω+20%/-30%
#A915AY-101M□	100μH ±20%	0.1MHz	430mA	440mA	0.667Ω+20%/-30%

Operating temp. range (Self-temp. rise included): -40 to 85°C

Class of Magnetic Shield: Ferrite Core

Only for reflow soldering

*Isat: Rated Current based on Inductance change

*Itemp: Rated Current based on Temperature rise

Rated current (Isat) is specified when the decrease of the initial inductance value at 30%. Rated current (Itemp) is specified when temperature of the inductor is raised 40°C by DC current.

Continued on the following page. ↗

Continued from the preceding page. ↘

Inductance-Current Characteristics (Typ.)



Temperature Rise Characteristics (Typ.)



D53LC Low Rdc Series 2020 (5252) inch (mm)



Packaging Code	Packaging	Minimum Quantity
=P3	ø330mm Embossed Taping	2000

Part Number (□: packaging code)	Inductance	Inductance Test Frequency	Rated Current (Isat)*	Rated Current (Itemp)*	DC Resistance
#A915BY-4R7M□	4.7µH ±20%	0.1MHz	1130mA	2180mA	0.029Ω+20%/-30%
#A915BY-6R8M□	6.8µH ±20%	0.1MHz	990mA	1810mA	0.042Ω+20%/-30%
#A915BY-100M□	10µH ±20%	0.1MHz	740mA	1500mA	0.056Ω+20%/-30%
#A915BY-150M□	15µH ±20%	0.1MHz	580mA	1280mA	0.081Ω+20%/-30%
#A915BY-220M□	22µH ±20%	0.1MHz	510mA	1120mA	0.112Ω+20%/-30%
#A915BY-330M□	33µH ±20%	0.1MHz	410mA	880mA	0.172Ω+20%/-30%
#A915BY-470M□	47µH ±20%	0.1MHz	340mA	750mA	0.224Ω+20%/-30%
#A915BY-680M□	68µH ±20%	0.1MHz	290mA	640mA	0.309Ω+20%/-30%
#A915BY-101M□	100µH ±20%	0.1MHz	260mA	510mA	0.474Ω+20%/-30%
#A915BY-151M□	150µH ±20%	0.1MHz	210mA	380mA	0.785Ω+20%/-30%
#A915BY-221M□	220µH ±20%	0.1MHz	180mA	330mA	0.995Ω+20%/-30%

Operating temp. range (Self-temp. rise included): -40 to 85°C

Class of Magnetic Shield: Ferrite Core

Only for reflow soldering

*Isat: Rated Current based on Inductance change

*Itemp: Rated Current based on Temperature rise

Rated current (Isat) is specified when the decrease of the initial inductance value at 30%. Rated current (Itemp) is specified when temperature of the inductor is raised 40°C by DC current.

Inductance-Current Characteristics (Typ.)



Temperature Rise Characteristics (Typ.)



LQH55DN_03 Series 2220 (5750) inch (mm)



Packaging Code	Packaging	Minimum Quantity
K	ø330mm Embossed Taping	1500
L	ø180mm Embossed Taping	350

Part Number (□: packaging code)	Inductance	Inductance Test Frequency	Rated Current	DC Resistance	S.R.F.* (min.)
LQH55DNR12M03□	0.12μH ±20%	1MHz	6.0A	0.007Ω±40%	450MHz
LQH55DNR27M03□	0.27μH ±20%	1MHz	5.3A	0.010Ω±40%	300MHz
LQH55DNR47M03□	0.47μH ±20%	1MHz	4.8A	0.013Ω±40%	200MHz
LQH55DN1R0M03□	1.0μH ±20%	1MHz	4.0A	0.019Ω±40%	150MHz
LQH55DN1R5M03□	1.5μH ±20%	1MHz	3.7A	0.022Ω±40%	110MHz
LQH55DN2R2M03□	2.2μH ±20%	1MHz	3.2A	0.029Ω±40%	80MHz
LQH55DN3R3M03□	3.3μH ±20%	1MHz	2.9A	0.036Ω±40%	40MHz
LQH55DN4R7M03□	4.7μH ±20%	1MHz	2.7A	0.041Ω±40%	30MHz
LQH55DN6R8M03□	6.8μH ±20%	1MHz	2.0A	0.074Ω±40%	25MHz
LQH55DN100M03□	10μH ±20%	1MHz	1.7A	0.093Ω±40%	20MHz
LQH55DN150M03□	15μH ±20%	1MHz	1.4A	0.15Ω±40%	17MHz
LQH55DN220M03□	22μH ±20%	1MHz	1.2A	0.19Ω±40%	15MHz
LQH55DN330M03□	33μH ±20%	1MHz	0.9A	0.32Ω±40%	12MHz
LQH55DN470M03□	47μH ±20%	1MHz	0.8A	0.40Ω±40%	10MHz
LQH55DN680M03□	68μH ±20%	1MHz	0.64A	0.67Ω±40%	7.6MHz
LQH55DN101M03□	100μH ±20%	100kHz	0.56A	0.86Ω±40%	6.5MHz
LQH55DN151M03□	150μH ±20%	100kHz	0.42A	1.9Ω±40%	5.0MHz
LQH55DN221M03□	220μH ±20%	100kHz	0.32A	2.4Ω±40%	4.0MHz
LQH55DN331M03□	330μH ±20%	100kHz	0.27A	4.4Ω±40%	3.1MHz
LQH55DN471M03□	470μH ±20%	100kHz	0.24A	5.4Ω±40%	2.4MHz
LQH55DN681M03□	680μH ±20%	100kHz	0.19A	8.1Ω±40%	1.9MHz
LQH55DN102M03□	1000μH ±20%	10kHz	0.15A	10.3Ω±40%	1.7MHz
LQH55DN222M03□	2200μH ±20%	10kHz	0.10A	21.5Ω±40%	1.2MHz
LQH55DN472M03□	4700μH ±20%	10kHz	0.07A	43.6Ω±40%	0.8MHz
LQH55DN103M03□	10000μH ±20%	10kHz	0.05A	100Ω±40%	0.5MHz

Operating temp. range: -40 to 80°C

Class of Magnetic Shield: No Shield

Only for reflow soldering

*S.R.F.: Self Resonant Frequency

When rated current is applied to the products, inductance will be within ±40% of initial inductance value. When rated current is applied to the products, the temperature rise caused by self-generated heat shall be limited to 40°C max.

Inductance-Frequency Characteristics (Typ.)



Inductance-Current Characteristics (Typ.)



Impedance-Frequency Characteristics (Typ.)



D63LCB Series 2424 (6060) inch (mm)



Packaging Code	Packaging	Minimum Quantity
=P3	ø330mm Embossed Taping	1500

Part Number (□: packaging code)	Inductance	Inductance Test Frequency	Rated Current (Isat)*	Rated Current (Itemp)*	DC Resistance
#A921CY-1R0M□	1.0μH ±20%	0.1MHz	3590mA	4520mA	0.011Ω+20%/-30%
#A921CY-1R5M□	1.5μH ±20%	0.1MHz	2930mA	3780mA	0.013Ω+20%/-30%
#A921CY-2R2M□	2.2μH ±20%	0.1MHz	2420mA	3510mA	0.016Ω+20%/-30%
#A921CY-3R6M□	3.6μH ±20%	0.1MHz	1890mA	3010mA	0.021Ω+20%/-30%
#A921CY-4R7M□	4.7μH ±20%	0.1MHz	1660mA	2580mA	0.027Ω+20%/-30%
#A921CY-6R2M□	6.2μH ±20%	0.1MHz	1450mA	2280mA	0.032Ω+20%/-30%
#A921CY-100M□	10μH ±20%	0.1MHz	1140mA	1910mA	0.049Ω+20%/-30%
#A921CY-120M□	12μH ±20%	0.1MHz	1040mA	1800mA	0.052Ω+20%/-30%
#A921CY-150M□	15μH ±20%	0.1MHz	930mA	1730mA	0.062Ω+20%/-30%
#A921CY-180M□	18μH ±20%	0.1MHz	850mA	1580mA	0.074Ω+20%/-30%
#A921CY-220M□	22μH ±20%	0.1MHz	770mA	1340mA	0.095Ω+20%/-30%
#A921CY-270M□	27μH ±20%	0.1MHz	700mA	1140mA	0.120Ω+20%/-30%
#A921CY-330M□	33μH ±20%	0.1MHz	630mA	1010mA	0.140Ω+20%/-30%
#A921CY-390M□	39μH ±20%	0.1MHz	580mA	980mA	0.150Ω+20%/-30%
#A921CY-470M□	47μH ±20%	0.1MHz	530mA	890mA	0.185Ω+20%/-30%
#A921CY-560M□	56μH ±20%	0.1MHz	480mA	820mA	0.220Ω+20%/-30%
#A921CY-680M□	68μH ±20%	0.1MHz	440mA	730mA	0.270Ω+20%/-30%
#A921CY-820M□	82μH ±20%	0.1MHz	400mA	640mA	0.330Ω+20%/-30%
#A921CY-101M□	100μH ±20%	0.1MHz	360mA	580mA	0.415Ω+20%/-30%
#A921CY-151M□	150μH ±20%	0.1MHz	310mA	440mA	0.615Ω+20%/-30%

Operating temp. range (Self-temp. rise included): -40 to 85°C

Class of Magnetic Shield: Ferrite Core

Only for reflow soldering

*Isat: Rated Current based on Inductance change

*Itemp: Rated Current based on Temperature rise

Rated current (Isat) is specified when the decrease of the initial inductance value at 30%. Rated current (Itemp) is specified when temperature of the inductor is raised 40°C by DC current.

Inductance-Current Characteristics (Typ.)



Temperature Rise Characteristics (Typ.)



DG6028C Series 2424 (6060) inch (mm)



Packaging Code	Packaging	Minimum Quantity
=P3	ø330mm Embossed Taping	2000

Part Number (□: packaging code)	Inductance	Inductance Test Frequency	Rated Current (Isat)*	Rated Current (Itemp)*	DC Resistance
1253AY-1R0N□	1.0μH ±30%	0.1MHz	5300mA	5800mA	0.012Ω±20%
1253AY-1R5N□	1.5μH ±30%	0.1MHz	4400mA	5400mA	0.016Ω±20%
1253AY-2R2N□	2.2μH ±30%	0.1MHz	4000mA	4800mA	0.020Ω±20%
1253AY-3R3N□	3.3μH ±30%	0.1MHz	2900mA	4000mA	0.028Ω±20%
1253AY-4R7M□	4.7μH ±20%	0.1MHz	2600mA	3600mA	0.034Ω±20%
1253AY-6R8M□	6.8μH ±20%	0.1MHz	2300mA	3100mA	0.047Ω±20%
1253AY-100M□	10μH ±20%	0.1MHz	1900mA	2500mA	0.067Ω±20%
1253AY-150M□	15μH ±20%	0.1MHz	1500mA	2000mA	0.094Ω±20%
1253AY-220M□	22μH ±20%	0.1MHz	1300mA	1700mA	0.145Ω±20%

Operating temp. range (Self-temp. rise included): -40 to 85°C

Class of Magnetic Shield: Magnetic Resin

Only for reflow soldering

*Isat: Rated Current based on Inductance change

*Itemp: Rated Current based on Temperature rise

Rated current (Isat) is specified when the decrease of the initial inductance value at 30%. Rated current (Itemp) is specified when temperature of the inductor is raised 40°C by DC current.

Inductance-Current Characteristics (Typ.)



Temperature Rise Characteristics (Typ.)



DG6045C Series 2424 (6060) inch (mm)



Packaging Code	Packaging	Minimum Quantity
=P3	ø330mm Embossed Taping	1500

Continued on the following page. ↗

Continued from the preceding page. ↘

Part Number (□: packaging code)	Inductance	Inductance Test Frequency	Rated Current (I _{sat})*	Rated Current (I _{temp})*	DC Resistance
1255AY-1R0N□	1.0μH ±30%	0.1MHz	9500mA	6500mA	0.010Ω±20%
1255AY-1R2N□	1.2μH ±30%	0.1MHz	8400mA	5900mA	0.012Ω±20%
1255AY-1R8N□	1.8μH ±30%	0.1MHz	6800mA	5300mA	0.014Ω±20%
1255AY-2R2N□	2.2μH ±30%	0.1MHz	6300mA	4700mA	0.016Ω±20%
1255AY-2R7N□	2.7μH ±30%	0.1MHz	5600mA	4600mA	0.018Ω±20%
1255AY-3R3N□	3.3μH ±30%	0.1MHz	5200mA	4400mA	0.021Ω±20%
1255AY-3R9N□	3.9μH ±30%	0.1MHz	4700mA	4200mA	0.022Ω±20%
1255AY-4R7M□	4.7μH ±20%	0.1MHz	4500mA	4000mA	0.023Ω±20%
1255AY-6R8M□	6.8μH ±20%	0.1MHz	3600mA	3400mA	0.036Ω±20%
1255AY-100M□	10μH ±20%	0.1MHz	3100mA	2900mA	0.047Ω±20%
1255AY-150M□	15μH ±20%	0.1MHz	2500mA	2400mA	0.063Ω±20%
1255AY-220M□	22μH ±20%	0.1MHz	2000mA	1900mA	0.098Ω±20%
1255AY-270M□	27μH ±20%	0.1MHz	1800mA	1800mA	0.135Ω±20%
1255AY-330M□	33μH ±20%	0.1MHz	1700mA	1500mA	0.145Ω±20%
1255AY-470M□	47μH ±20%	0.1MHz	1400mA	1300mA	0.210Ω±20%
1255AY-680M□	68μH ±20%	0.1MHz	1200mA	1000mA	0.310Ω±20%
1255AY-101M□	100μH ±20%	0.1MHz	900mA	900mA	0.460Ω±20%

Operating temp. range (Self-temp. rise included): -40 to 85°C
 Class of Magnetic Shield: Magnetic Resin

Only for reflow soldering

*I_{sat}: Rated Current based on Inductance change

*I_{temp}: Rated Current based on Temperature rise

Rated current (I_{sat}) is specified when the decrease of the initial inductance value at 30%. Rated current (I_{temp}) is specified when temperature of the inductor is raised 40°C by DC current.

Inductance-Current Characteristics (Typ.)



Temperature Rise Characteristics (Typ.)



DG6050C Series 2424 (6060) inch (mm)



Packaging Code	Packaging	Minimum Quantity
=P3	ø330mm Embossed Taping	1500

Continued on the following page. ↗

Inductors for Power Lines DG6050C
 Inductors for General Circuits
 RF Inductors

Continued from the preceding page. ↘

Part Number (□: packaging code)	Inductance	Inductance Test Frequency	Rated Current (I _{sat})*	Rated Current (I _{temp})*	DC Resistance
1264EY-1R2N□	1.2μH ±30%	0.1MHz	9800mA	6300mA	0.012Ω±20%
1264EY-1R5N□	1.5μH ±30%	0.1MHz	8300mA	5500mA	0.014Ω±20%
1264EY-2R2N□	2.2μH ±30%	0.1MHz	7800mA	5300mA	0.016Ω±20%
1264EY-3R3N□	3.3μH ±30%	0.1MHz	6500mA	4800mA	0.021Ω±20%
1264EY-4R7M□	4.7μH ±20%	0.1MHz	5400mA	3700mA	0.029Ω±20%
1264EY-6R8M□	6.8μH ±20%	0.1MHz	4400mA	3400mA	0.035Ω±20%
1264EY-100M□	10μH ±20%	0.1MHz	3500mA	3100mA	0.045Ω±20%
1264EY-150M□	15μH ±20%	0.1MHz	3000mA	2100mA	0.087Ω±20%
1264EY-220M□	22μH ±20%	0.1MHz	2300mA	1800mA	0.110Ω±20%
1264EY-330M□	33μH ±20%	0.1MHz	1900mA	1400mA	0.170Ω±20%
1264EY-470M□	47μH ±20%	0.1MHz	1700mA	1200mA	0.260Ω±20%
1264EY-680M□	68μH ±20%	0.1MHz	1400mA	1100mA	0.325Ω±20%
1264EY-101M□	100μH ±20%	0.1MHz	1200mA	900mA	0.460Ω±20%

Operating temp. range (Self-temp. rise included): -40 to 85°C

Class of Magnetic Shield: Magnetic Resin

Only for reflow soldering

*I_{sat}: Rated Current based on Inductance change

*I_{temp}: Rated Current based on Temperature rise

Rated current (I_{sat}) is specified when the decrease of the initial inductance value at 30%. Rated current (I_{temp}) is specified when temperature of the inductor is raised 40°C by DC current.

Inductance-Current Characteristics (Typ.)



Temperature Rise Characteristics (Typ.)



LQH66SN_03 Series 2525 (6363) inch (mm)

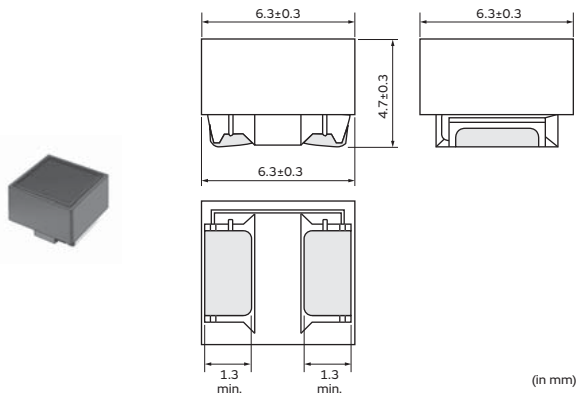

Packaging Code	Packaging	Minimum Quantity
K	ø330mm Embossed Taping	1500
L	ø180mm Embossed Taping	350

Part Number (□: packaging code)	Inductance	Inductance Test Frequency	Rated Current	DC Resistance	S.R.F.* (min.)
LQH66SNR27M03□	0.27μH ±20%	1MHz	6.0A	0.007Ω±40%	300MHz
LQH66SNR68M03□	0.68μH ±20%	1MHz	5.3A	0.010Ω±40%	180MHz
LQH66SN1R0M03□	1.0μH ±20%	1MHz	4.7A	0.013Ω±40%	150MHz
LQH66SN1R5M03□	1.5μH ±20%	1MHz	3.8A	0.016Ω±40%	110MHz
LQH66SN2R2M03□	2.2μH ±20%	1MHz	3.3A	0.019Ω±40%	80MHz

Operating temp. range: -40 to 80°C

Class of Magnetic Shield: Ferrite Core

Only for reflow soldering

*S.R.F.: Self Resonant Frequency

When rated current is applied to the products, inductance will be within ±10% of initial inductance value. When rated current is applied to the products, the temperature rise caused by self-generated heat shall be limited to 40°C max.

Continued on the following page. ↗

Continued from the preceding page. ↘

Part Number (□: packaging code)	Inductance	Inductance Test Frequency	Rated Current	DC Resistance	S.R.F.* (min.)
LQH66SN3R3M03□	3.3μH ±20%	1MHz	2.6A	0.022Ω±40%	40MHz
LQH66SN4R7M03□	4.7μH ±20%	1MHz	2.2A	0.025Ω±40%	30MHz
LQH66SN6R8M03□	6.8μH ±20%	1MHz	1.8A	0.029Ω±40%	25MHz
LQH66SN100M03□	10μH ±20%	1MHz	1.6A	0.036Ω±40%	20MHz
LQH66SN150M03□	15μH ±20%	1MHz	1.3A	0.069Ω±40%	17MHz
LQH66SN220M03□	22μH ±20%	1MHz	1.1A	0.087Ω±40%	15MHz
LQH66SN330M03□	33μH ±20%	1MHz	0.86A	0.14Ω±40%	12MHz
LQH66SN470M03□	47μH ±20%	1MHz	0.76A	0.17Ω±40%	10MHz
LQH66SN680M03□	68μH ±20%	1MHz	0.60A	0.29Ω±40%	7.6MHz
LQH66SN101M03□	100μH ±20%	100kHz	0.52A	0.36Ω±40%	6.5MHz
LQH66SN151M03□	150μH ±20%	100kHz	0.42A	0.63Ω±40%	5.0MHz
LQH66SN221M03□	220μH ±20%	100kHz	0.35A	0.79Ω±40%	4.0MHz
LQH66SN331M03□	330μH ±20%	100kHz	0.28A	1.8Ω±40%	3.2MHz
LQH66SN471M03□	470μH ±20%	100kHz	0.24A	2.2Ω±40%	2.5MHz
LQH66SN681M03□	680μH ±20%	100kHz	0.20A	3.9Ω±40%	2.0MHz
LQH66SN102M03□	1000μH ±20%	10kHz	0.16A	4.9Ω±40%	1.7MHz
LQH66SN222M03□	2200μH ±20%	10kHz	0.10A	9.4Ω±40%	1.2MHz
LQH66SN472M03□	4700μH ±20%	10kHz	0.07A	19.5Ω±40%	0.8MHz
LQH66SN103M03□	10000μH ±20%	10kHz	0.05A	39.7Ω±40%	0.5MHz

Operating temp. range: -40 to 80°C
 Class of Magnetic Shield: Ferrite Core
 Only for reflow soldering
 *S.R.F.: Self Resonant Frequency

When rated current is applied to the products, inductance will be within ±10% of initial inductance value. When rated current is applied to the products, the temperature rise caused by self-generated heat shall be limited to 40°C max.

Inductance-Frequency Characteristics (Typ.)



Inductance-Current Characteristics (Typ.)



Impedance-Frequency Characteristics (Typ.)



DS75LC Series 2929 (7373) inch (mm)



Packaging Code	Packaging	Minimum Quantity
=P3	ø330mm Embossed Taping	1000

Continued on the following page. ↗

Continued from the preceding page. ↘

Part Number (□: packaging code)	Inductance	Inductance Test Frequency	Rated Current (Isat)*	Rated Current (Itemp)*	Max. of DC Resistance
B1047AS-1R0N□	1.0μH ±30%	0.1MHz	9200mA	6400mA	0.012Ω
B1047AS-1R5N□	1.5μH ±30%	0.1MHz	7700mA	5900mA	0.014Ω
B1047AS-2R2N□	2.2μH ±30%	0.1MHz	6500mA	5500mA	0.016Ω
B1047AS-2R7N□	2.7μH ±30%	0.1MHz	5600mA	5100mA	0.018Ω
B1047AS-3R6N□	3.6μH ±30%	0.1MHz	5000mA	4400mA	0.023Ω
B1047AS-4R7N□	4.7μH ±30%	0.1MHz	4500mA	4100mA	0.026Ω
B1047AS-5R6N□	5.6μH ±30%	0.1MHz	4000mA	3500mA	0.032Ω
B1047AS-6R8N□	6.8μH ±30%	0.1MHz	3600mA	3400mA	0.036Ω
B1047AS-8R2N□	8.2μH ±30%	0.1MHz	3200mA	3000mA	0.042Ω
B1047AS-100M□	10μH ±20%	0.1MHz	2900mA	2700mA	0.053Ω
B1047AS-120M□	12μH ±20%	0.1MHz	2700mA	2400mA	0.063Ω
B1047AS-150M□	15μH ±20%	0.1MHz	2400mA	2200mA	0.071Ω
B1047AS-180M□	18μH ±20%	0.1MHz	2200mA	1900mA	0.110Ω
B1047AS-220M□	22μH ±20%	0.1MHz	2000mA	1800mA	0.120Ω
B1047AS-270M□	27μH ±20%	0.1MHz	1800mA	1600mA	0.130Ω
B1047AS-330M□	33μH ±20%	0.1MHz	1640mA	1500mA	0.170Ω
B1047AS-390M□	39μH ±20%	0.1MHz	1500mA	1400mA	0.180Ω
B1047AS-470M□	47μH ±20%	0.1MHz	1380mA	1300mA	0.200Ω
B1047AS-560M□	56μH ±20%	0.1MHz	1240mA	1200mA	0.230Ω
B1047AS-680M□	68μH ±20%	0.1MHz	1130mA	1000mA	0.280Ω
B1047AS-820M□	82μH ±20%	0.1MHz	1000mA	940mA	0.320Ω
B1047AS-101M□	100μH ±20%	0.1MHz	940mA	770mA	0.460Ω
B1047AS-151M□	150μH ±20%	0.1MHz	760mA	600mA	0.710Ω
B1047AS-221M□	220μH ±20%	0.1MHz	620mA	470mA	1.100Ω
B1047AS-331M□	330μH ±20%	0.1MHz	510mA	410mA	1.400Ω
B1047AS-471M□	470μH ±20%	0.1MHz	430mA	370mA	1.700Ω

Operating temp. range (Self-temp. rise included): -40 to 85°C

Class of Magnetic Shield: Ferrite Core

Only for reflow soldering

*Isat: Rated Current based on Inductance change

*Itemp: Rated Current based on Temperature rise

Rated current (Isat) is specified when the decrease of the initial inductance value at 30%. Rated current (Itemp) is specified when temperature of the inductor is raised 40°C by DC current.

Inductance-Current Characteristics (Typ.)



Temperature Rise Characteristics (Typ.)



DS75LC

Inductors for Power Lines

Inductors for General Circuits

RF Inductors

DEM8030C Series 3131 (8080) inch (mm)



Packaging Code	Packaging	Minimum Quantity
=P3	ø330mm Embossed Taping	1000

Part Number (□: packaging code)	Inductance	Inductance Test Frequency	Rated Current (Isat)*	Rated Current (Itemp)*	DC Resistance
1273AS-H-1R5N□	1.5μH ±30%	0.1MHz	7500mA	7300mA	0.0083Ω±20%
1273AS-H-2R2N□	2.2μH ±30%	0.1MHz	6200mA	6500mA	0.0110Ω±20%
1273AS-H-3R3N□	3.3μH ±30%	0.1MHz	5200mA	5400mA	0.0160Ω±20%
1273AS-H-4R7N□	4.7μH ±30%	0.1MHz	4400mA	4900mA	0.0190Ω±20%
1273AS-H-6R8N□	6.8μH ±30%	0.1MHz	3400mA	3700mA	0.0310Ω±20%
1273AS-H-100M□	10μH ±20%	0.1MHz	2900mA	3100mA	0.0450Ω±20%
1273AS-H-150M□	15μH ±20%	0.1MHz	2400mA	2600mA	0.0650Ω±20%
1273AS-H-220M□	22μH ±20%	0.1MHz	2000mA	2000mA	0.1050Ω±20%
1273AS-H-330M□	33μH ±20%	0.1MHz	1600mA	1900mA	0.1450Ω±20%
1273AS-H-470M□	47μH ±20%	0.1MHz	1300mA	1300mA	0.2410Ω±20%

Operating temp. range (Self-temp. rise included): -40 to 85°C

Class of Magnetic Shield: Ferrite Core

Only for reflow soldering

*Isat: Rated Current based on Inductance change

*Itemp: Rated Current based on Temperature rise

Rated current (Isat) is specified when the decrease of the initial inductance value at 30%. Rated current (Itemp) is specified when temperature of the inductor is raised 40°C by DC current.

Inductance-Current Characteristics (Typ.)



Temperature Rise Characteristics (Typ.)



DEM8040C Series 3131 (8080) inch (mm)



Packaging Code	Packaging	Minimum Quantity
=P3	ø330mm Embossed Taping	1000

Continued on the following page. ↗

Continued from the preceding page. ↘

Part Number (□: packaging code)	Inductance	Inductance Test Frequency	Rated Current (Isat)*	Rated Current (Itemp)*	DC Resistance
1248AS-H-1R5N□	1.5μH ±30%	0.1MHz	10000mA	8000mA	0.0084Ω±20%
1248AS-H-2R2N□	2.2μH ±30%	0.1MHz	8600mA	7000mA	0.0110Ω±20%
1248AS-H-3R3N□	3.3μH ±30%	0.1MHz	7200mA	5600mA	0.0160Ω±20%
1248AS-H-4R7N□	4.7μH ±30%	0.1MHz	6200mA	5300mA	0.0190Ω±20%
1248AS-H-6R8N□	6.8μH ±30%	0.1MHz	4800mA	4200mA	0.0300Ω±20%
1248AS-H-100M□	10μH ±20%	0.1MHz	4100mA	3400mA	0.0440Ω±20%
1248AS-H-150M□	15μH ±20%	0.1MHz	3400mA	2700mA	0.0650Ω±20%
1248AS-H-220M□	22μH ±20%	0.1MHz	2800mA	2200mA	0.1050Ω±20%
1248AS-H-330M□	33μH ±20%	0.1MHz	2400mA	1800mA	0.1400Ω±20%

Operating temp. range (Self-temp. rise included): -40 to 85°C

Class of Magnetic Shield: Ferrite Core

Only for reflow soldering

*Isat: Rated Current based on Inductance change

*Itemp: Rated Current based on Temperature rise

Rated current (Isat) is specified when the decrease of the initial inductance value at 30%. Rated current (Itemp) is specified when temperature of the inductor is raised 40°C by DC current.

Inductance-Current Characteristics (Typ.)



Temperature Rise Characteristics (Typ.)



DEM8045C Series 3131 (8080) inch (mm)

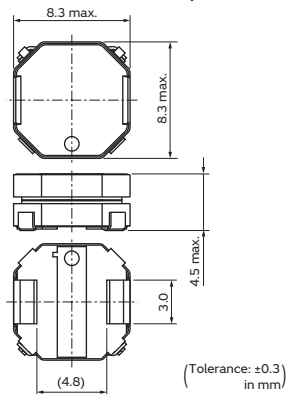

Packaging Code	Packaging	Minimum Quantity
=P3	ø330mm Embossed Taping	1000

Part Number (□: packaging code)	Inductance	Inductance Test Frequency	Rated Current (Isat)*	Rated Current (Itemp)*	DC Resistance
1217AS-H-1R5N□	1.5μH ±30%	0.1MHz	11200mA	9400mA	0.0065Ω±20%
1217AS-H-2R2N□	2.2μH ±30%	0.1MHz	9300mA	8700mA	0.0083Ω±20%
1217AS-H-3R3N□	3.3μH ±30%	0.1MHz	7700mA	6800mA	0.0120Ω±20%
1217AS-H-4R7N□	4.7μH ±30%	0.1MHz	6700mA	6300mA	0.0150Ω±20%
1217AS-H-5R6N□	5.6μH ±30%	0.1MHz	6100mA	5400mA	0.0190Ω±20%
1217AS-H-6R8N□	6.8μH ±30%	0.1MHz	5200mA	4800mA	0.0230Ω±20%
1217AS-H-8R2M□	8.2μH ±20%	0.1MHz	4800mA	4500mA	0.0280Ω±20%
1217AS-H-100M□	10μH ±20%	0.1MHz	4300mA	3900mA	0.0330Ω±20%
1217AS-H-150M□	15μH ±20%	0.1MHz	3300mA	3500mA	0.0440Ω±20%

Operating temp. range (Self-temp. rise included): -40 to 85°C

Class of Magnetic Shield: Ferrite Core

Only for reflow soldering

*Isat: Rated Current based on Inductance change

*Itemp: Rated Current based on Temperature rise

Rated current (Isat) is specified when the decrease of the initial inductance value at 30%. Rated current (Itemp) is specified when temperature of the inductor is raised 40°C by DC current.

Continued on the following page. ↗

Continued from the preceding page. ↘

Part Number (□: packaging code)	Inductance	Inductance Test Frequency	Rated Current (Isat)*	Rated Current (Itemp)*	DC Resistance
1217AS-H-180M□	18μH ±20%	0.1MHz	3200mA	2900mA	0.0640Ω±20%
1217AS-H-220M□	22μH ±20%	0.1MHz	2900mA	2400mA	0.0780Ω±20%
1217AS-H-330M□	33μH ±20%	0.1MHz	2300mA	2200mA	0.1100Ω±20%
1217AS-H-470M□	47μH ±20%	0.1MHz	2100mA	1800mA	0.1700Ω±20%

Operating temp. range (Self-temp. rise included): -40 to 85°C

Class of Magnetic Shield: Ferrite Core

Only for reflow soldering

*Isat: Rated Current based on Inductance change

*Itemp: Rated Current based on Temperature rise

Rated current (Isat) is specified when the decrease of the initial inductance value at 30%. Rated current (Itemp) is specified when temperature of the inductor is raised 40°C by DC current.

Inductance-Current Characteristics (Typ.)



Temperature Rise Characteristics (Typ.)



DG8040C Series 3131 (8080) inch (mm)



Packaging Code	Packaging	Minimum Quantity
=P3	ø330mm Embossed Taping	1000

Part Number (□: packaging code)	Inductance	Inductance Test Frequency	Rated Current (Isat)*	Rated Current (Itemp)*	DC Resistance
1267AY-1R0N□	1.0μH ±30%	0.1MHz	10400mA	8400mA	0.007Ω±20%
1267AY-1R5N□	1.5μH ±30%	0.1MHz	8200mA	7300mA	0.009Ω±20%
1267AY-2R2N□	2.2μH ±30%	0.1MHz	7400mA	6500mA	0.011Ω±20%
1267AY-3R3N□	3.3μH ±30%	0.1MHz	6100mA	6100mA	0.013Ω±20%
1267AY-4R7N□	4.7μH ±30%	0.1MHz	5100mA	5300mA	0.017Ω±20%
1267AY-6R8N□	6.8μH ±30%	0.1MHz	4000mA	4500mA	0.022Ω±20%
1267AY-100M□	10μH ±20%	0.1MHz	3300mA	3900mA	0.033Ω±20%
1267AY-150M□	15μH ±20%	0.1MHz	2600mA	3200mA	0.049Ω±20%
1267AY-220M□	22μH ±20%	0.1MHz	2300mA	2800mA	0.062Ω±20%
1267AY-330M□	33μH ±20%	0.1MHz	1900mA	2200mA	0.100Ω±20%
1267AY-470M□	47μH ±20%	0.1MHz	1600mA	1900mA	0.140Ω±20%
1267AY-680M□	68μH ±20%	0.1MHz	1300mA	1600mA	0.200Ω±20%
1267AY-101M□	100μH ±20%	0.1MHz	1100mA	1300mA	0.280Ω±20%

Operating temp. range (Self-temp. rise included): -40 to 85°C

Class of Magnetic Shield: Magnetic Resin

Only for reflow soldering

*Isat: Rated Current based on Inductance change

*Itemp: Rated Current based on Temperature rise

Rated current (Isat) is specified when the decrease of the initial inductance value at 30%. Rated current (Itemp) is specified when temperature of the inductor is raised 40°C by DC current.

Continued on the following page. ↗

Continued from the preceding page. ↘

Inductance-Current Characteristics (Typ.)



Temperature Rise Characteristics (Typ.)



DEM10050C Series 3939 (100100) inch (mm)



Packaging Code	Packaging	Minimum Quantity
=P3	ø330mm Embossed Taping	500

Part Number (□: packaging code)	Inductance	Inductance Test Frequency	Rated Current (Isat)*	Rated Current (Itemp)*	DC Resistance
1274AS-H-1R5N□	1.5µH ±30%	0.1MHz	15300mA	8900mA	0.0064Ω±20%
1274AS-H-2R2N□	2.2µH ±30%	0.1MHz	12600mA	8000mA	0.0080Ω±20%
1274AS-H-3R3N□	3.3µH ±30%	0.1MHz	10800mA	7400mA	0.0095Ω±20%
1274AS-H-4R7N□	4.7µH ±30%	0.1MHz	9500mA	6700mA	0.0112Ω±20%
1274AS-H-5R6N□	5.6µH ±30%	0.1MHz	8300mA	6300mA	0.0152Ω±20%
1274AS-H-6R8N□	6.8µH ±30%	0.1MHz	7500mA	5400mA	0.0177Ω±20%
1274AS-H-8R2M□	8.2µH ±20%	0.1MHz	6800mA	4800mA	0.0220Ω±20%
1274AS-H-100M□	10µH ±20%	0.1MHz	6200mA	4400mA	0.0253Ω±20%
1274AS-H-150M□	15µH ±20%	0.1MHz	5100mA	3900mA	0.0352Ω±20%
1274AS-H-220M□	22µH ±20%	0.1MHz	4200mA	2900mA	0.0567Ω±20%
1274AS-H-330M□	33µH ±20%	0.1MHz	3500mA	2500mA	0.0780Ω±20%

Operating temp. range (Self-temp. rise included): -40 to 85°C

Class of Magnetic Shield: Ferrite Core

Only for reflow soldering

*Isat: Rated Current based on Inductance change

*Itemp: Rated Current based on Temperature rise

Rated current (Isat) is specified when the decrease of the initial inductance value at 30%. Rated current (Itemp) is specified when temperature of the inductor is raised 40°C by DC current.

Inductance-Current Characteristics (Typ.)



Temperature Rise Characteristics (Typ.)



DEM10050C

Inductors for Power Lines

Inductors for General Circuits

RF Inductors

DEM10050C_DD Series 3939 (100100) inch (mm)



Packaging Code	Packaging	Minimum Quantity
=P3	ø330mm Embossed Taping	500

Part Number (□: packaging code)	Inductance	Inductance Test Frequency	Rated Current (Isat)*	Rated Current (Itemp)*	DC Resistance
DD1274AS-H-1R5N□	1.5μH ±30%	0.1MHz	15300mA	8900mA	0.0064Ω±20%
DD1274AS-H-2R2N□	2.2μH ±30%	0.1MHz	12600mA	8000mA	0.0080Ω±20%
DD1274AS-H-3R3N□	3.3μH ±30%	0.1MHz	10800mA	7400mA	0.0095Ω±20%
DD1274AS-H-4R7N□	4.7μH ±30%	0.1MHz	9500mA	6700mA	0.0112Ω±20%
DD1274AS-H-5R6N□	5.6μH ±30%	0.1MHz	8300mA	6300mA	0.0152Ω±20%
DD1274AS-H-6R8N□	6.8μH ±30%	0.1MHz	7500mA	5400mA	0.0177Ω±20%
DD1274AS-H-8R2M□	8.2μH ±20%	0.1MHz	6800mA	4800mA	0.0220Ω±20%
DD1274AS-H-100M□	10μH ±20%	0.1MHz	6200mA	4400mA	0.0253Ω±20%
DD1274AS-H-150M□	15μH ±20%	0.1MHz	5100mA	3900mA	0.0352Ω±20%
DD1274AS-H-220M□	22μH ±20%	0.1MHz	4200mA	2900mA	0.0567Ω±20%
DD1274AS-H-330M□	33μH ±20%	0.1MHz	3500mA	2500mA	0.0780Ω±20%

Operating temp. range (Self-temp. rise included): -40 to 105°C

Class of Magnetic Shield: Ferrite Core

Only for reflow soldering

*Isat: Rated Current based on Inductance change

*Itemp: Rated Current based on Temperature rise

Rated current (Isat) is specified when the decrease of the initial inductance value at 30%. Rated current (Itemp) is specified when temperature of the inductor is raised 40°C by DC current.

Inductance-Current Characteristics (Typ.)



Temperature Rise Characteristics (Typ.)



Notice (Rating)

Max. current (DC, AC) as function of ambient temperature (derating curve).

Derating of Rated Current



DS104C2 Series 4040 (101101) inch (mm)



Packaging Code	Packaging	Minimum Quantity
=P3	ø330mm Embossed Taping	500

Continued on the following page. ↗

Continued from the preceding page. ↘

Part Number (□: packaging code)	Inductance	Inductance Test Frequency	Rated Current (Isat)*	Rated Current (Itemp)*	Max. of DC Resistance
#B952AS-H-1R1N□	1.1μH ±30%	0.1MHz	11700mA	6000mA	0.011Ω
#B952AS-H-1R8N□	1.8μH ±30%	0.1MHz	8700mA	5400mA	0.014Ω
#B952AS-H-2R7N□	2.7μH ±30%	0.1MHz	7300mA	4900mA	0.016Ω
#B952AS-H-3R9N□	3.9μH ±30%	0.1MHz	5800mA	4600mA	0.018Ω
#B952AS-H-5R1N□	5.1μH ±30%	0.1MHz	4900mA	3800mA	0.026Ω
#B952AS-H-6R8N□	6.8μH ±30%	0.1MHz	4500mA	3100mA	0.035Ω
#B952AS-H-8R2N□	8.2μH ±30%	0.1MHz	4100mA	2900mA	0.040Ω
#B952AS-H-100M□	10μH ±20%	0.1MHz	3600mA	2700mA	0.044Ω
#B952AS-H-120M□	12μH ±20%	0.1MHz	3300mA	2500mA	0.051Ω
#B952AS-H-150M□	15μH ±20%	0.1MHz	3100mA	2300mA	0.062Ω
#B952AS-H-180M□	18μH ±20%	0.1MHz	2700mA	2000mA	0.079Ω
#B952AS-H-220M□	22μH ±20%	0.1MHz	2400mA	1900mA	0.087Ω
#B952AS-H-270M□	27μH ±20%	0.1MHz	2200mA	1800mA	0.100Ω
#B952AS-H-330M□	33μH ±20%	0.1MHz	2000mA	1600mA	0.125Ω
#B952AS-H-390M□	39μH ±20%	0.1MHz	1800mA	1400mA	0.150Ω
#B952AS-H-470M□	47μH ±20%	0.1MHz	1700mA	1300mA	0.175Ω
#B952AS-H-560M□	56μH ±20%	0.1MHz	1500mA	1200mA	0.195Ω
#B952AS-H-680M□	68μH ±20%	0.1MHz	1300mA	1100mA	0.240Ω
#B952AS-H-820M□	82μH ±20%	0.1MHz	1200mA	1000mA	0.295Ω
#B952AS-H-101M□	100μH ±20%	0.1MHz	1100mA	900mA	0.380Ω
#B952AS-H-121M□	120μH ±20%	0.1MHz	970mA	800mA	0.460Ω

Operating temp. range (Self-temp. rise included): -40 to 85°C

Class of Magnetic Shield: Ferrite Core

Only for reflow soldering

*Isat: Rated Current based on Inductance change

*Itemp: Rated Current based on Temperature rise

Rated current (Isat) is specified when the decrease of the initial inductance value at 10%. Rated current (Itemp) is specified when temperature of the inductor is raised 40°C by DC current.

Inductance-Current Characteristics (Typ.)



Temperature Rise Characteristics (Typ.)



DS106C2 Series 4040 (101101) inch (mm)



Packaging Code	Packaging	Minimum Quantity
=P3	ø330mm Embossed Taping	500

Continued on the following page. ↗

Continued from the preceding page. ↘

Part Number (□: packaging code)	Inductance	Inductance Test Frequency	Rated Current (Isat)*	Rated Current (Itemp)*	Max. of DC Resistance
#B966AS-1R2N□	1.2μH ±30%	0.1MHz	12000mA	7200mA	0.011Ω
#B966AS-1R8N□	1.8μH ±30%	0.1MHz	9800mA	6700mA	0.014Ω
#B966AS-2R7N□	2.7μH ±30%	0.1MHz	8100mA	6100mA	0.015Ω
#B966AS-3R9N□	3.9μH ±30%	0.1MHz	7100mA	5600mA	0.017Ω
#B966AS-4R7N□	4.7μH ±30%	0.1MHz	6100mA	5400mA	0.018Ω
#B966AS-6R8N□	6.8μH ±30%	0.1MHz	5200mA	5000mA	0.021Ω
#B966AS-8R2N□	8.2μH ±30%	0.1MHz	4800mA	4600mA	0.024Ω
#B966AS-100M□	10μH ±20%	0.1MHz	4400mA	4300mA	0.028Ω
#B966AS-120M□	12μH ±20%	0.1MHz	3900mA	3700mA	0.035Ω
#B966AS-160M□	16μH ±20%	0.1MHz	3300mA	2700mA	0.060Ω
#B966BS-180M□	18μH ±20%	0.1MHz	2800mA	2600mA	0.060Ω
#B966BS-220M□	22μH ±20%	0.1MHz	2700mA	2500mA	0.065Ω
#B966BS-270M□	27μH ±20%	0.1MHz	2400mA	2300mA	0.074Ω
#B966BS-330M□	33μH ±20%	0.1MHz	2100mA	2200mA	0.083Ω
#B966BS-390M□	39μH ±20%	0.1MHz	2100mA	2200mA	0.093Ω
#B966BS-470M□	47μH ±20%	0.1MHz	1800mA	1800mA	0.120Ω
#B966BS-560M□	56μH ±20%	0.1MHz	1600mA	1600mA	0.145Ω
#B966BS-680M□	68μH ±20%	0.1MHz	1400mA	1400mA	0.190Ω
#B966BS-101M□	100μH ±20%	0.1MHz	1200mA	1200mA	0.255Ω
#B966BS-151M□	150μH ±20%	0.1MHz	1000mA	970mA	0.385Ω
#B966BS-221M□	220μH ±20%	0.1MHz	840mA	760mA	0.610Ω
#B966BS-271M□	270μH ±20%	0.1MHz	750mA	710mA	0.690Ω
#B966BS-331M□	330μH ±20%	0.1MHz	690mA	680mA	0.760Ω

Operating temp. range (Self-temp. rise included): -40 to 85°C

Class of Magnetic Shield: Ferrite Core

Only for reflow soldering

*Isat: Rated Current based on Inductance change

*Itemp: Rated Current based on Temperature rise

Rated current (Isat) is specified when the decrease of the initial inductance value at 10%. Rated current (Itemp) is specified when temperature of the inductor is raised 40°C by DC current.

Inductance-Current Characteristics (Typ.)

Temperature Rise Characteristics (Typ.)



DS126C2 Series 4949 (125125) inch (mm)



Packaging Code	Packaging	Minimum Quantity
=P3	ø330mm Embossed Taping	500

Continued on the following page. ↗

Inductors for Power Lines DS126C2
 Inductors for General Circuits
 RF Inductors

Continued from the preceding page. ↘

Part Number (□: packaging code)	Inductance	Inductance Test Frequency	Rated Current (Isat)*	Rated Current (Itemp)*	Max. of DC Resistance
#B953AS-1R7N□	1.7μH ±30%	0.1MHz	11800mA	7700mA	0.010Ω
#B953AS-2R7N□	2.7μH ±30%	0.1MHz	9000mA	7000mA	0.011Ω
#B953AS-3R9N□	3.9μH ±30%	0.1MHz	7900mA	6000mA	0.014Ω
#B953AS-5R6N□	5.6μH ±30%	0.1MHz	6800mA	5600mA	0.016Ω
#B953AS-7R5N□	7.5μH ±30%	0.1MHz	5700mA	5100mA	0.017Ω
#B953AS-100M□	10μH ±20%	0.1MHz	5500mA	4400mA	0.023Ω
#B953AS-120M□	12μH ±20%	0.1MHz	5000mA	4000mA	0.027Ω
#B953AS-150M□	15μH ±20%	0.1MHz	4500mA	3600mA	0.032Ω
#B953AS-180M□	18μH ±20%	0.1MHz	4100mA	3200mA	0.040Ω
#B953AS-220M□	22μH ±20%	0.1MHz	3600mA	2900mA	0.046Ω
#B953AS-270M□	27μH ±20%	0.1MHz	3200mA	2800mA	0.050Ω
#B953AS-330M□	33μH ±20%	0.1MHz	3000mA	2400mA	0.064Ω
#B953AS-390M□	39μH ±20%	0.1MHz	2700mA	2200mA	0.074Ω
#B953AS-470M□	47μH ±20%	0.1MHz	2400mA	2100mA	0.082Ω
#B953AS-560M□	56μH ±20%	0.1MHz	2000mA	1900mA	0.105Ω
#B953AS-680M□	68μH ±20%	0.1MHz	1700mA	1700mA	0.120Ω
#B953AS-820M□	82μH ±20%	0.1MHz	1600mA	1600mA	0.145Ω
#B953AS-101M□	100μH ±20%	0.1MHz	1500mA	1400mA	0.170Ω
#B953AS-121M□	120μH ±20%	0.1MHz	1300mA	1300mA	0.185Ω
#B953AS-151M□	150μH ±20%	0.1MHz	1200mA	1200mA	0.235Ω
#B953AS-181M□	180μH ±20%	0.1MHz	1100mA	1100mA	0.290Ω
#B953AS-221M□	220μH ±20%	0.1MHz	1000mA	1000mA	0.350Ω
#B953AS-271M□	270μH ±20%	0.1MHz	930mA	920mA	0.415Ω
#B953AS-331M□	330μH ±20%	0.1MHz	830mA	830mA	0.495Ω
#B953AS-391M□	390μH ±20%	0.1MHz	760mA	770mA	0.610Ω
#B953AS-471M□	470μH ±20%	0.1MHz	670mA	700mA	0.705Ω
#B953AS-561M□	560μH ±20%	0.1MHz	620mA	640mA	0.900Ω
#B953AS-681M□	680μH ±20%	0.1MHz	550mA	580mA	1.120Ω

Operating temp. range (Self-temp. rise included): -40 to 85°C

Class of Magnetic Shield: Ferrite Core

Only for reflow soldering

*Isat: Rated Current based on Inductance change

*Itemp: Rated Current based on Temperature rise

Rated current (Isat) is specified when the decrease of the initial inductance value at 10%. Rated current (Itemp) is specified when temperature of the inductor is raised 40°C by DC current.

Inductance-Current Characteristics (Typ.)



Temperature Rise Characteristics (Typ.)



LQM18FN_00 Series 0603 (1608) inch (mm)



(in mm)

Packaging Code	Packaging	Minimum Quantity
D	ø180mm Paper Taping	4000
J	ø330mm Paper Taping	10000
B	Packing in Bulk	1000

Part Number (□: packaging code)	Inductance	Inductance Test Frequency	Rated Current	DC Resistance	S.R.F.* (min.)
LQM18FN1R0M00 □	1.0μH ±20%	1MHz	150mA	0.20Ω±30%	120MHz
LQM18FN2R2M00 □	2.2μH ±20%	1MHz	120mA	0.40Ω±30%	80MHz
LQM18FN4R7M00 □	4.7μH ±20%	1MHz	80mA	0.60Ω±30%	50MHz
LQM18FN100M00 □	10μH ±20%	1MHz	50mA	0.90Ω±30%	30MHz

Operating temp. range: -55 to 125°C
 Class of Magnetic Shield: Ferrite Core
 *S.R.F.: Self Resonant Frequency

Inductance-Frequency Characteristics (Typ.)



Inductance-Current Characteristics (Typ.)



Impedance-Frequency Characteristics (Typ.)



LQM18PN_B0 Series 0603 (1608) inch (mm)



(in mm)

Packaging Code	Packaging	Minimum Quantity
L	ø180mm Embossed Taping	4000
B	Packing in Bulk	1000

Continued on the following page. ↗

Continued from the preceding page. ↘

Part Number (□: packaging code)	Inductance	Inductance Test Frequency	Rated Current	DC Resistance	S.R.F.* (min.)
LQM18PN1R5NBO□	1.5μH ±30%	1MHz	600mA	0.35Ω±25%	50MHz

Operating temp. range: -55 to 125°C
 Class of Magnetic Shield: Ferrite Core
 *S.R.F.: Self Resonant Frequency

Inductance-Frequency Characteristics (Typ.)



Inductance-Current Characteristics (Typ.)



Temperature Rise Characteristics (Typ.)



LQM18PN_C0 Series 0603 (1608) inch (mm)



(in mm)

Packaging Code	Packaging	Minimum Quantity
L	ø180mm Embossed Taping	4000
B	Packing in Bulk	1000

Part Number (□: packaging code)	Inductance	Inductance Test Frequency	Rated Current	DC Resistance	S.R.F.* (min.)
LQM18PNR47NCO□	0.47μH ±30%	1MHz	850mA	0.15Ω±25%	50MHz
LQM18PN1R0NCO□	1.0μH ±30%	1MHz	750mA	0.20Ω±25%	50MHz
LQM18PN1R5NCO□	1.5μH ±30%	1MHz	720mA	0.22Ω±25%	50MHz
LQM18PN1R8NCO□	1.8μH ±30%	1MHz	700mA	0.24Ω±25%	50MHz
LQM18PN2R2NCO□	2.2μH ±30%	1MHz	700mA	0.24Ω±25%	50MHz

Operating temp. range: -55 to 125°C
 Class of Magnetic Shield: Ferrite Core
 *S.R.F.: Self Resonant Frequency

Inductance-Frequency Characteristics (Typ.)



Inductance-Current Characteristics (Typ.)



Temperature Rise Characteristics (Typ.)



LQM18PN_D0 Series 0603 (1608) inch (mm)



(in mm)

Packaging Code	Packaging	Minimum Quantity
D	ø180mm Paper Taping	4000
B	Packing in Bulk	1000

Part Number (□: packaging code)	Inductance	Inductance Test Frequency	Rated Current	DC Resistance	S.R.F.* (min.)
LQM18PN2R5NDO □	2.5μH ±30%	1MHz	700mA	0.24Ω±25%	60MHz

Operating temp. range: -40 to 85°C
 Class of Magnetic Shield: Ferrite Core
 *S.R.F.: Self Resonant Frequency

Inductance-Frequency Characteristics (Typ.)

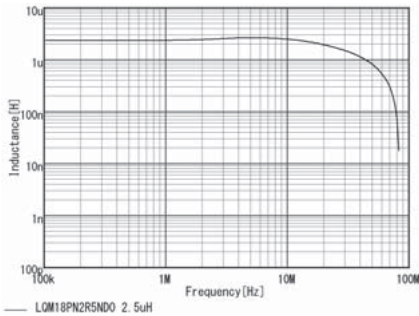

Inductance-Current Characteristics (Typ.)

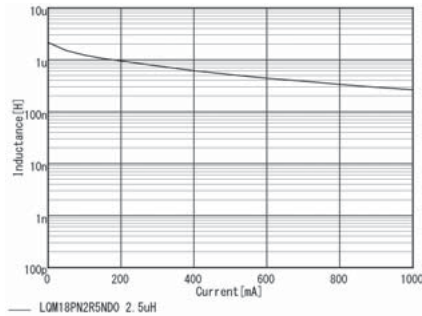

Temperature Rise Characteristics (Typ.)



LQM18PN_DH Series 0603 (1608) inch (mm)



(in mm)

Packaging Code	Packaging	Minimum Quantity
D	ø180mm Paper Taping	4000
B	Packing in Bulk	1000

Part Number (□: packaging code)	Inductance	Inductance Test Frequency	Rated Current (Isat)*	Rated Current (Itemp)*	DC Resistance	S.R.F.* (min.)
LQM18PN2R2MDH □	2.2μH ±20%	1MHz	250mA(Max) / 300mA(Typ.)	650mA(Max) / 800mA(Typ.)	0.38Ω(typ.)	60MHz

Operating temp. range: -40 to 85°C
 Class of Magnetic Shield: Ferrite Core
 Only for reflow soldering

*Isat: Rated Current based on Inductance change
 *Itemp: Rated Current based on Temperature rise
 *S.R.F.: Self Resonant Frequency

When rated current is applied to the products, inductance will be within ±30% of initial inductance value range. When rated current is applied to the products, the temperature rise caused by self-generated heat shall be limited to 40°C max. Keep the temperature (ambient temperature plus self-generation of heat) under 125°C.

Continued on the following page. ↗

Continued from the preceding page. ↘

Inductance-Frequency Characteristics (Typ.)



Inductance-Current Characteristics (Typ.)



Temperature Rise Characteristics (Typ.)



LQM18PN_F0 Series 0603 (1608) inch (mm)



Packaging Code	Packaging	Minimum Quantity
L	ø180mm Embossed Taping	4000
B	Packing in Bulk	1000

Part Number (□: packaging code)	Inductance	Inductance Test Frequency	Rated Current	DC Resistance	S.R.F.* (min.)
LQM18PN1RONFO□	1.0μH ±30%	1MHz	600mA	0.28Ω±25%	50MHz

Operating temp. range: -55 to 125°C
 Class of Magnetic Shield: Ferrite Core
 *S.R.F.: Self Resonant Frequency

Inductance-Frequency Characteristics (Typ.)



Inductance-Current Characteristics (Typ.)



Temperature Rise Characteristics (Typ.)



LQM18PN_F0
 Inductors for Power Lines

Inductors for General Circuits

RF Inductors

LQM18PN_FH Series 0603 (1608) inch (mm)



Packaging Code	Packaging	Minimum Quantity
D	ø180mm Paper Taping	4000
B	Packing in Bulk	1000

Part Number (□: packaging code)	Inductance	Inductance Test Frequency	Rated Current (Isat)*	Rated Current (Itemp)*	DC Resistance	S.R.F.* (min.)
LQM18PNR47MFH □	0.47μH ±20%	1MHz	1.3A(Max.) / 1.5A(Typ.)	1.4A(Max.) / 1.7A(Typ.)	0.1Ω(typ.)	100MHz
LQM18PN1R0MFH □	1.0μH ±20%	1MHz	0.55A(Max.) / 0.7A(Typ.)	1.3A(Max.) / 1.45A(Typ.)	0.13Ω(typ.)	100MHz
LQM18PN1R5MFH □	1.5μH ±20%	1MHz	0.4A(Max.) / 0.5A(Typ.)	1.1A(Max.) / 1.25A(Typ.)	0.17Ω(typ.)	80MHz
LQM18PN2R2MFH □	2.2μH ±20%	1MHz	0.3A(Max.) / 0.35A(Typ.)	0.7A(Max.) / 0.9A(Typ.)	0.38Ω(typ.)	80MHz

Operating temp. range: -40 to 85°C
 Class of Magnetic Shield: Ferrite Core

Only for reflow soldering

*Isat: Rated Current based on Inductance change

*Itemp: Rated Current based on Temperature rise

*S.R.F.: Self Resonant Frequency

When rated current is applied to the products, inductance will be within ±30% of initial inductance value range. When rated current is applied to the products, the temperature rise caused by self-generated heat shall be limited to 40°C max. Keep the temperature (ambient temperature plus self-generation of heat) under 125°C.

Inductance-Frequency Characteristics (Typ.)



Inductance-Current Characteristics (Typ.)



Temperature Rise Characteristics (Typ.)



LQM18PN_FR Series 0603 (1608) inch (mm)



Packaging Code	Packaging	Minimum Quantity
L	ø180mm Embossed Taping	4000
B	Packing in Bulk	1000

Continued on the following page. ↗

Continued from the preceding page. ↘

Part Number (□: packaging code)	Inductance	Inductance Test Frequency	Rated Current	DC Resistance	S.R.F.* (min.)
LQM18PNR22NFR□	0.22μH ±30%	1MHz	1250mA	0.11Ω±25%	100MHz
LQM18PNR47NFR□	0.47μH ±30%	1MHz	1100mA	0.15Ω±25%	100MHz
LQM18PN1R0MFRR□	1.0μH ±20%	1MHz	950mA	0.20Ω±25%	100MHz
LQM18PN1R5MFRR□	1.5μH ±20%	1MHz	800mA	0.23Ω±25%	100MHz
LQM18PN2R2MFRR□	2.2μH ±20%	1MHz	750mA	0.30Ω±25%	70MHz
LQM18PN3R3MFRR□	3.3μH ±20%	1MHz	700mA	0.35Ω±25%	60MHz
LQM18PN4R7MFRR□	4.7μH ±20%	1MHz	620mA	0.44Ω±25%	40MHz

Operating temp. range: -40 to 85°C
 Class of Magnetic Shield: Ferrite Core
 *S.R.F.: Self Resonant Frequency

Inductance-Frequency Characteristics (Typ.)



Inductance-Current Characteristics (Typ.)



Temperature Rise Characteristics (Typ.)



LQM18PN_GH Series 0603 (1608) inch (mm)



(in mm)

Packaging Code	Packaging	Minimum Quantity
D	ø180mm Paper Taping	4000
B	Packing in Bulk	1000

Part Number (□: packaging code)	Inductance	Inductance Test Frequency	Rated Current (Isat)*	Rated Current (Itemp)*	DC Resistance	S.R.F.* (min.)
LQM18PN1R0MGH□	1.0μH ±20%	1MHz	0.8A(Max.) / 0.9A(Typ.)	1.05A(Max.) / 1.15A(Typ.)	0.2Ω(typ.)	100MHz
LQM18PN2R2MGH□	2.2μH ±20%	1MHz	0.25A(Max.) / 0.35A(Typ.)	1.05A(Max.) / 1.15A(Typ.)	0.2Ω(typ.)	70MHz
LQM18PN3R3MGH□	3.3μH ±20%	1MHz	0.15A(Max.) / 0.2A(Typ.)	1.05A(Max.) / 1.15A(Typ.)	0.2Ω(typ.)	30MHz

Operating temp. range: -40 to 85°C
 Class of Magnetic Shield: Ferrite Core
 Only for reflow soldering

*Isat: Rated Current based on Inductance change
 *Itemp: Rated Current based on Temperature rise
 *S.R.F.: Self Resonant Frequency

When rated current is applied to the products, inductance will be within ±30% of initial inductance value. When rated current is applied to the products, the temperature rise caused by self-generated heat shall be limited to 40°C max. Keep the temperature (ambient temperature plus self-generation of heat) under 125°C.

Continued on the following page. ↗

Continued from the preceding page. ↘

Inductance-Frequency Characteristics (Typ.)



Inductance-Current Characteristics (Typ.)



Temperature Rise Characteristics (Typ.)



LQM18PW_CH Series 0603 (1608) inch (mm)



Dimension of T	Inductance: 1.0 to 2.2μH	
		0.50±0.15
	Inductance: 2.5μH	

(in mm)

Packaging Code	Packaging	Minimum Quantity
D	ø180mm Paper Taping	4000
B	Packing in Bulk	1000

Part Number (□: packaging code)	Inductance	Inductance Test Frequency	Rated Current (Isat)*	Rated Current (Itemp)*	DC Resistance	S.R.F.* (min.)
LQM18PW1R0MCH□	1.0μH ±20%	1MHz	0.60A(Max) / 0.70A(Typ.)	0.95A(Max) / 1.05A(Typ.)	0.23Ω(typ.)	70MHz
LQM18PW2R2MCH□	2.2μH ±20%	1MHz	0.20A(Max) / 0.30A(Typ.)	0.75A(Max) / 0.85A(Typ.)	0.38Ω(typ.)	50MHz
LQM18PW2R5NCH□	2.5μH ±30%	1MHz	0.10A(Max) / 0.15A(Typ.)	0.90A(Max) / 1.00A(Typ.)	0.24Ω(typ.)	50MHz

Operating temp. range: -40 to 85°C

Class of Magnetic Shield: Ferrite Core

Only for reflow soldering

*Isat: Rated Current based on Inductance change

*Itemp: Rated Current based on Temperature rise

*S.R.F.: Self Resonant Frequency

When rated current is applied to the products, inductance will be within ±30% of initial inductance value range. When rated current is applied to the products, the temperature rise caused by self-generated heat shall be limited to 40°C max. Keep the temperature (ambient temperature plus self-generation of heat) under 125°C.

Inductance-Frequency Characteristics (Typ.)



Inductance-Current Characteristics (Typ.)



Temperature Rise Characteristics (Typ.)



LQM21DN_00 Series 0805 (2012) inch (mm)



Dimension of t	Inductance: 1.0 to 10μH	0.85±0.2
	Inductance: 22 to 47μH	1.25±0.2

(Inductance: 1.0μH to 10μH)

Packaging Code	Packaging	Minimum Quantity
D	ø180mm Paper Taping	4000
J	ø330mm Paper Taping	10000
B	Packing in Bulk	1000

(Inductance: 22μH to 47μH)

Packaging Code	Packaging	Minimum Quantity
K	ø330mm Embossed Taping	10000
L	ø180mm Embossed Taping	3000
B	Packing in Bulk	1000

Part Number (□: packaging code)	Inductance	Inductance Test Frequency	Rated Current	Max. of DC Resistance	S.R.F.* (min.)
LQM21DN1R0N00□	1.0μH ±30%	1MHz	60mA	0.10Ω	75MHz
LQM21DN2R2N00□	2.2μH ±30%	1MHz	40mA	0.17Ω	50MHz
LQM21DN4R7N00□	4.7μH ±30%	1MHz	30mA	0.30Ω	35MHz
LQM21DN100N00□	10μH ±30%	1MHz	15mA	0.50Ω	24MHz
LQM21DN220N00□	22μH ±30%	1MHz	13mA	0.65Ω	16MHz
LQM21DN470N00□	47μH ±30%	1MHz	7mA	1.20Ω	7.5MHz

Operating temp. range: -40 to 85°C
 Class of Magnetic Shield: Ferrite Core
 *S.R.F.: Self Resonant Frequency

Inductance-Frequency Characteristics (Typ.)



Inductance-Current Characteristics (Typ.)



Impedance-Frequency Characteristics (Typ.)



LQM21FN_00 Series 0805 (2012) inch (mm)



Dimension of t	Inductance: 1.0 to 2.2μH	0.85±0.2
	Inductance: 4.7 to 47μH	1.25±0.2

(Inductance: 1.0μH to 2.2μH)

Packaging Code	Packaging	Minimum Quantity
D	ø180mm Paper Taping	4000
J	ø330mm Paper Taping	10000
B	Packing in Bulk	1000

(Inductance: 4.7μH to 47μH)

Packaging Code	Packaging	Minimum Quantity
K	ø330mm Embossed Taping	10000
L	ø180mm Embossed Taping	3000
B	Packing in Bulk	1000

Continued on the following page. ↗

Continued from the preceding page. ↘

Part Number (□: packaging code)	Inductance	Inductance Test Frequency	Rated Current	DC Resistance	S.R.F.* (min.)
LQM21FN1R0N00□	1.0μH ±30%	1MHz	220mA	0.20Ω±30%	105MHz
LQM21FN2R2N00□	2.2μH ±30%	1MHz	150mA	0.28Ω±30%	70MHz
LQM21FN4R7N00□	4.7μH ±30%	1MHz	80mA	0.30Ω±30%	25MHz
LQM21FN100N00□	10μH ±30%	1MHz	60mA	0.50Ω±30%	15MHz
LQM21FN220N00□	22μH ±30%	1MHz	13mA	0.35Ω±30%	15MHz
LQM21FN470N00□	47μH ±30%	1MHz	7mA	0.60Ω±30%	7.5MHz

Operating temp. range: -40 to 85°C
 Class of Magnetic Shield: Ferrite Core
 *S.R.F.: Self Resonant Frequency

Inductance-Frequency Characteristics (Typ.)



Inductance-Current Characteristics (Typ.)



Impedance-Frequency Characteristics (Typ.)



LQM21FN_70 Series 0805 (2012) inch (mm)



(in mm)

Packaging Code	Packaging	Minimum Quantity
L	ø180mm Embossed Taping	3000
B	Packing in Bulk	1000

Part Number (□: packaging code)	Inductance	Inductance Test Frequency	Rated Current	DC Resistance	S.R.F.* (min.)
LQM21FN4R7M70□	4.7μH ±20%	1MHz	120mA	0.35Ω±30%	25MHz
LQM21FN100M70□	10μH ±20%	1MHz	100mA	0.60Ω±30%	15MHz

Operating temp. range: -55 to 125°C
 Class of Magnetic Shield: Ferrite Core
 *S.R.F.: Self Resonant Frequency

Inductance-Frequency Characteristics (Typ.)



Inductance-Current Characteristics (Typ.)



Impedance-Frequency Characteristics (Typ.)



Inductors for Power Lines LQM21FN_70
 Inductors for General Circuits
 RF Inductors

LQM21FN_80 Series 0805 (2012) inch (mm)



Packaging Code	Packaging	Minimum Quantity
K	ø330mm Embossed Taping	10000
L	ø180mm Embossed Taping	3000
B	Packing in Bulk	1000

Part Number (□: packaging code)	Inductance	Inductance Test Frequency	Rated Current	DC Resistance	S.R.F.* (min.)
LQM21FN4R7M80 □	4.7μH ±20%	1MHz	120mA	0.18Ω±30%	25MHz
LQM21FN100M80 □	10μH ±20%	1MHz	100mA	0.30Ω±30%	15MHz

Operating temp. range (Self-temp. rise not included): -55 to 125°C
 Class of Magnetic Shield: Ferrite Core
 *S.R.F.: Self Resonant Frequency

Inductance-Frequency Characteristics (Typ.)



Inductance-Current Characteristics (Typ.)



Impedance-Frequency Characteristics (Typ.)



LQM21PN_C0 Series 0805 (2012) inch (mm)



Packaging Code	Packaging	Minimum Quantity
D	ø180mm Paper Taping	4000
B	Packing in Bulk	1000

Continued on the following page. ↗

Continued from the preceding page. ↘

Part Number (□: packaging code)	Inductance	Inductance Test Frequency	Rated Current	DC Resistance	S.R.F.* (min.)
LQM21PNR47MC0□	0.47μH ±20%	1MHz	1.1A(Ambient temp.85°C) 0.82A(Ambient temp.125°C)	0.12Ω±25%	100MHz
LQM21PN1R0MC0□	1.0μH ±20%	1MHz	0.8A(Ambient temp.85°C) 0.60A(Ambient temp.125°C)	0.19Ω±25%	90MHz
LQM21PN1R5MC0□	1.5μH ±20%	1MHz	0.7A(Ambient temp.85°C) 0.52A(Ambient temp.125°C)	0.26Ω±25%	70MHz
LQM21PN2R2MC0□	2.2μH ±20%	1MHz	0.6A(Ambient temp.85°C) 0.45A(Ambient temp.125°C)	0.34Ω±25%	50MHz

Operating temp. range: -55 to 125°C

Class of Magnetic Shield: Ferrite Core

*S.R.F.: Self Resonant Frequency

In operating temperatures exceeding +85°C, derating of current is necessary for the LQM21P_C0 series. Please apply the derating curve shown in the chart according to the operating temperature. Please consider "Notice (Rating)." When rated current is applied to the products, the temperature rise caused by self-generated heat shall be limited to 40°C max.

Inductance-Frequency Characteristics (Typ.)



Inductance-Current Characteristics (Typ.)



Temperature Rise Characteristics (Typ.)



Notice (Rating)

In operating temperatures exceeding +85°C, derating of current is necessary for this series. Please apply the derating curve shown in the chart according to the operating temperature.

Derating of Rated Current



LQM21PN_CA Series 0805 (2012) inch (mm)



(in mm)

Packaging Code	Packaging	Minimum Quantity
D	ø180mm Paper Taping	3000
B	Packing in Bulk	1000

Continued on the following page. ↗

Continued from the preceding page. ↘

Part Number (□: packaging code)	Inductance	Inductance Test Frequency	Rated Current (Isat)*	Rated Current (Itemp)*	DC Resistance	S.R.F.* (min.)
LQM21PN2R2MCA□	2.2μH ±20%	1MHz	0.28A(Max.) / 0.30A(Typ.)	1.05A(Max.) / 1.30A(Typ.)	0.2Ω(typ.)	40MHz

Operating temp. range: -40 to 85°C
 Class of Magnetic Shield: Ferrite Core

Only for reflow soldering

*Isat: Rated Current based on Inductance change

*Itemp: Rated Current based on Temperature rise

*S.R.F.: Self Resonant Frequency

When rated current is applied to the products, inductance will be within ±30% of initial inductance value range. When rated current is applied to the products, the temperature rise caused by self-generated heat shall be limited to 40°C max. Keep the temperature (ambient temperature plus self-generation of heat) under 125°C.

Inductance-Frequency Characteristics (Typ.)



Inductance-Current Characteristics (Typ.)



Temperature Rise Characteristics (Typ.)



LQM21PN_CH Series 0805 (2012) inch (mm)



Packaging Code	Packaging	Minimum Quantity
D	ø180mm Paper Taping	3000
J	ø330mm Paper Taping	10000
B	Packing in Bulk	1000

Part Number (□: packaging code)	Inductance	Inductance Test Frequency	Rated Current (Isat)*	Rated Current (Itemp)*	DC Resistance	S.R.F.* (min.)
LQM21PNR47MCH□	0.47μH ±20%	1MHz	1.6A(Max.) / 1.8A(Typ.)	1.4A(Max.) / 1.8A(Typ.)	0.11Ω(typ.)	80MHz
LQM21PNR82MCH□	0.82μH ±20%	1MHz	0.7A(Max.) / 0.9A(Typ.)	1.3A(Max.) / 1.6A(Typ.)	0.13Ω(typ.)	60MHz
LQM21PN1R0MCH□	1.0μH ±20%	1MHz	0.35A(Max.) / 0.5A(Typ.)	1.2A(Max.) / 1.5A(Typ.)	0.15Ω(typ.)	50MHz
LQM21PN1R5MCH□	1.5μH ±20%	1MHz	0.25A(Max.) / 0.4A(Typ.)	1.1A(Max.) / 1.4A(Typ.)	0.17Ω(typ.)	40MHz
LQM21PN2R2MCH□	2.2μH ±20%	1MHz	0.18A(Max.) / 0.2A(Typ.)	1.05A(Max.) / 1.3A(Typ.)	0.2Ω(typ.)	30MHz

Operating temp. range: -40 to 85°C

Class of Magnetic Shield: Ferrite Core

Only for reflow soldering

*Isat: Rated Current based on Inductance change

*Itemp: Rated Current based on Temperature rise

*S.R.F.: Self Resonant Frequency

When rated current is applied to the products, inductance will be within ±30% of initial inductance value range. When rated current is applied to the products, the temperature rise caused by self-generated heat shall be limited to 40°C max. Keep the temperature (ambient temperature plus self-generation of heat) under 125°C.

Continued on the following page. ↗

Continued from the preceding page. ↘

Inductance-Frequency Characteristics (Typ.)



Inductance-Current Characteristics (Typ.)



Temperature Rise Characteristics (Typ.)



LQM21PN_EH Series 0805 (2012) inch (mm)

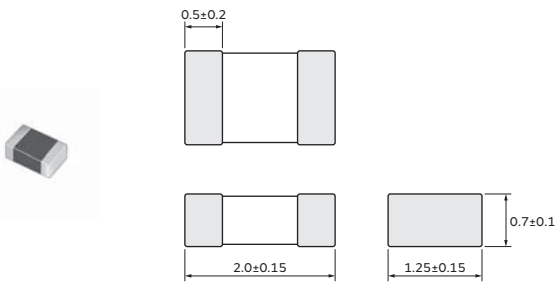

(in mm)

Packaging Code	Packaging	Minimum Quantity
D	ø180mm Paper Taping	3000
B	Packing in Bulk	1000

Part Number (□: packaging code)	Inductance	Inductance Test Frequency	Rated Current (Isat)*	Rated Current (Itemp)*	DC Resistance	S.R.F.* (min.)
LQM21PNR24MEH□	0.24μH ±20%	1MHz	2.8A(Max.) / 3.1A(Typ.)	2.4A(Max.) / 2.9A(Typ.)	0.04Ω(typ.)	130MHz
LQM21PNR47MEH□	0.47μH ±20%	1MHz	1.5A(Max.) / 1.8A(Typ.)	1.9A(Max.) / 2.4A(Typ.)	0.06Ω(typ.)	80MHz
LQM21PN1R0MEH□	1.0μH ±20%	1MHz	0.8A(Max.) / 1A(Typ.)	1.6A(Max.) / 2A(Typ.)	0.085Ω(typ.)	50MHz
LQM21PN1R5MEH□	1.5μH ±20%	1MHz	0.4A(Max.) / 0.55A(Typ.)	1.5A(Max.) / 1.8A(Typ.)	0.1Ω(typ.)	40MHz
LQM21PN2R2MEH□	2.2μH ±20%	1MHz	0.3A(Max.) / 0.45A(Typ.)	1.1A(Max.) / 1.4A(Typ.)	0.175Ω(typ.)	30MHz

Operating temp. range: -40 to 85°C

Class of Magnetic Shield: Ferrite Core

Only for reflow soldering

*Isat: Rated Current based on Inductance change

*Itemp: Rated Current based on Temperature rise

*S.R.F.: Self Resonant Frequency

When rated current is applied to the products, inductance will be within ±30% of initial inductance value range. When rated current is applied to the products, the temperature rise caused by self-generated heat shall be limited to 40°C max. Keep the temperature (ambient temperature plus self-generation of heat) under 125°C.

Inductance-Frequency Characteristics (Typ.)



Inductance-Current Characteristics (Typ.)



Temperature Rise Characteristics (Typ.)

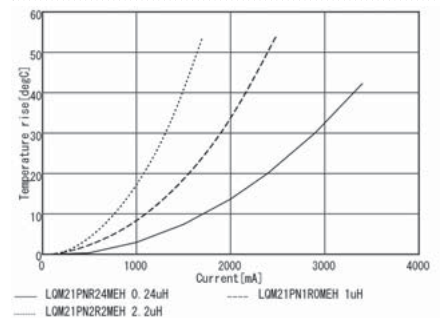

LQM21PN_G0 Series 0805 (2012) inch (mm)



Packaging Code	Packaging	Minimum Quantity
D	ø180mm Paper Taping	4000
B	Packing in Bulk	1000

Part Number (□: packaging code)	Inductance	Inductance Test Frequency	Rated Current	DC Resistance	S.R.F.* (min.)
LQM21PNR47MG0□	0.47μH ±20%	1MHz	1.3A(Ambient temp.85°C) 0.95A(Ambient temp.125°C)	0.075Ω(typ.)	100MHz
LQM21PNR54MG0□	0.54μH ±20%	1MHz	1.3A(Ambient temp.85°C) 0.95A(Ambient temp.125°C)	0.075Ω(typ.)	100MHz
LQM21PN3R3MG0□	3.3μH ±20%	1MHz	0.8A(Ambient temp.85°C) 0.55A(Ambient temp.125°C)	0.165Ω(typ.)	30MHz
LQM21PN3R3NG0□	3.3μH ±30%	1MHz	0.8A(Ambient temp.85°C) 0.55A(Ambient temp.125°C)	0.165Ω(typ.)	30MHz

Operating temp. range: -55 to 125°C

Class of Magnetic Shield: Ferrite Core

*S.R.F.: Self Resonant Frequency

In operating temperatures exceeding +85°C, derating of current is necessary for the LQM21P_G0 series. Please apply the derating curve shown in the chart according to the operating temperature. Please consider "Notice (Rating)." When rated current is applied to the products, the temperature rise caused by self-generated heat shall be limited to 40°C max.

Inductance-Frequency Characteristics (Typ.)

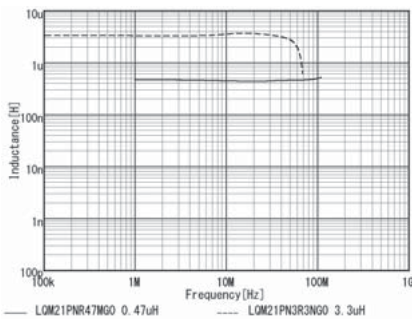

Inductance-Current Characteristics (Typ.)

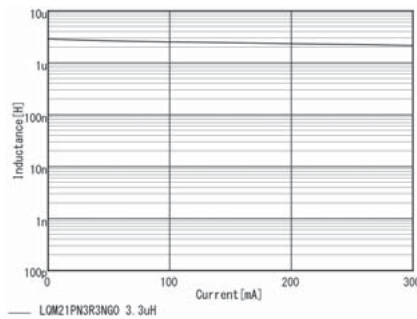

Temperature Rise Characteristics (Typ.)

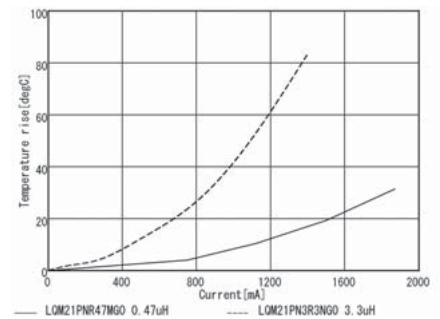

Notice (Rating)

In operating temperatures exceeding +85°C, derating of current is necessary for this series.

Please apply the derating curve shown in the chart according to the operating temperature.

Derating of Rated Current

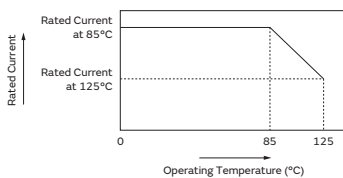

LQM21PN_GC Series 0805 (2012) inch (mm)



Packaging Code	Packaging	Minimum Quantity
D	ø180mm Paper Taping	4000
B	Packing in Bulk	1000

Part Number (□: packaging code)	Inductance	Inductance Test Frequency	Rated Current	DC Resistance	S.R.F.* (min.)
LQM21PN1R0NGC□	1.0μH ±30%	1MHz	0.9A(Ambient temp.85°C) 0.65A(Ambient temp.125°C)	0.10Ω±25%	50MHz
LQM21PN2R2NGC□	2.2μH ±30%	1MHz	0.8A(Ambient temp.85°C) 0.6A(Ambient temp.125°C)	0.23Ω±25%	40MHz

Operating temp. range: -55 to 125°C

Class of Magnetic Shield: Ferrite Core

*S.R.F.: Self Resonant Frequency

In operating temperatures exceeding +85°C, derating of current is necessary for the LQM21P_GC series. Please apply the derating curve shown in the chart according to the operating temperature. Please consider "Notice (Rating)." When rated current is applied to the products, the temperature rise caused by self-generated heat shall be limited to 40°C max.

Inductance-Frequency Characteristics (Typ.)



Inductance-Current Characteristics (Typ.)



Temperature Rise Characteristics (Typ.)

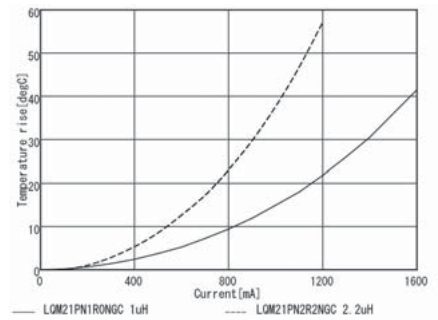

Notice (Rating)

In operating temperatures exceeding +85°C, derating of current is necessary for this series.

Please apply the derating curve shown in the chart according to the operating temperature.

Derating of Rated Current



LQM21PN_GH Series 0805 (2012) inch (mm)



Packaging Code	Packaging	Minimum Quantity
L	ø180mm Embossed Taping	3000
B	Packing in Bulk	1000

Part Number (□: packaging code)	Inductance	Inductance Test Frequency	Rated Current (Isat)*	Rated Current (Itemp)*	DC Resistance	S.R.F.* (min.)
LQM21PNR47MGH□	0.47μH ±20%	1MHz	1.8A(Max) / 2.4A(Typ.)	2.4A(Max) / 3.1A(Typ.)	0.04Ω(typ.)	80MHz
LQM21PN1R0MGH□	1.0μH ±20%	1MHz	1.1A(Max) / 1.5A(Typ.)	1.7A(Max) / 2.0A(Typ.)	0.08Ω(typ.)	60MHz
LQM21PN1R5MGH□	1.5μH ±20%	1MHz	0.64A(Max) / 1.2A(Typ.)	1.4A(Max) / 1.8A(Typ.)	0.11Ω(typ.)	50MHz
LQM21PN2R2MGH□	2.2μH ±20%	1MHz	0.45A(Max) / 0.7A(Typ.)	1.3A(Max) / 1.7A(Typ.)	0.125Ω(typ.)	40MHz
LQM21PN4R7MGH□	4.7μH ±20%	1MHz	0.25A(Max) / 0.27A(Typ.)	1.0A(Max) / 1.2A(Typ.)	0.22Ω(typ.)	20MHz

Operating temp. range: -40 to 85°C

Class of Magnetic Shield: Ferrite Core

Only for reflow soldering

*Isat: Rated Current based on Inductance change

*Itemp: Rated Current based on Temperature rise

*S.R.F.: Self Resonant Frequency

When rated current is applied to the products, inductance will be within ±30% of initial inductance value range. When rated current is applied to the products, the temperature rise caused by self-generated heat shall be limited to 40°C max. Keep the temperature (ambient temperature plus self-generation of heat) under 125°C.

Inductance-Frequency Characteristics (Typ.)



Inductance-Current Characteristics (Typ.)



Temperature Rise Characteristics (Typ.)



LQM21PN_GR Series 0805 (2012) inch (mm)



Packaging Code	Packaging	Minimum Quantity
D	ø180mm Paper Taping	4000
B	Packing in Bulk	1000

Continued on the following page. ↗

Continued from the preceding page. ↘

Part Number (□: packaging code)	Inductance	Inductance Test Frequency	Rated Current	DC Resistance	S.R.F.* (min.)
LQM21PN1R0NGR□	1.0μH ±30%	1MHz	1.3A(Ambient temp.85°C) 0.95A(Ambient temp.125°C)	0.066Ω±25%	50MHz
LQM21PN3R3MGR□	3.3μH ±20%	1MHz	1.0A(Ambient temp.85°C) 0.75A(Ambient temp.125°C)	0.150Ω±25%	30MHz
LQM21PN3R3NGR□	3.3μH ±30%	1MHz	1.0A(Ambient temp.85°C) 0.75A(Ambient temp.125°C)	0.150Ω±25%	30MHz
LQM21PN4R7MGR□	4.7μH ±20%	1MHz	0.8A(Ambient temp.85°C) 0.6A(Ambient temp.125°C)	0.23Ω±25%	30MHz
LQM21PN4R7NGR□	4.7μH ±30%	1MHz	0.8A(Ambient temp.85°C) 0.6A(Ambient temp.125°C)	0.23Ω±25%	30MHz

Operating temp. range: -55 to 125°C

Class of Magnetic Shield: Ferrite Core

*S.R.F.: Self Resonant Frequency

In operating temperatures exceeding +85°C, derating of current is necessary for the LQM21P_GR series. Please apply the derating curve shown in the chart according to the operating temperature. Please consider "Notice (Rating)." When rated current is applied to the products, the temperature rise caused by self-generated heat shall be limited to 40°C max.

Inductance-Frequency Characteristics (Typ.)



Inductance-Current Characteristics (Typ.)



Temperature Rise Characteristics (Typ.)



Notice (Rating)

In operating temperatures exceeding +85°C, derating of current is necessary for this series.

Please apply the derating curve shown in the chart according to the operating temperature.

Derating of Rated Current



LQM21PN_GS Series 0805 (2012) inch (mm)



Packaging Code	Packaging	Minimum Quantity
D	ø180mm Paper Taping	4000
B	Packing in Bulk	1000

(in mm)

Continued on the following page. ↗

Continued from the preceding page. ↘

Part Number (□: packaging code)	Inductance	Inductance Test Frequency	Rated Current	DC Resistance	S.R.F.* (min.)
LQM21PN2R2MGS□	2.2μH ±20%	1MHz	950mA	0.180Ω±25%	40MHz
LQM21PN4R7MGS□	4.7μH ±20%	1MHz	750mA	0.290Ω±25%	20MHz

Operating temp. range: -40 to 85°C
 Class of Magnetic Shield: Ferrite Core
 *S.R.F.: Self Resonant Frequency

Inductance-Frequency Characteristics (Typ.)



Inductance-Current Characteristics (Typ.)



Temperature Rise Characteristics (Typ.)



LQM2MPN_DH Series 0806 (2016) inch (mm)



Packaging Code	Packaging	Minimum Quantity
L	ø180mm Embossed Taping	3000
B	Packing in Bulk	1000

Part Number (□: packaging code)	Inductance	Inductance Test Frequency	Rated Current (I _{sat})*	Rated Current (I _{temp})*	DC Resistance	S.R.F.* (min.)
LQM2MPN2R2MDH□	2.2μH ±20%	1MHz	0.63A(Max.) / 0.68A(Typ.)	1.27A(Max.) / 1.35A(Typ.)	0.2Ω(typ.)	40MHz

Operating temp. range: -40 to 85°C
 Class of Magnetic Shield: Ferrite Core
 Only for reflow soldering
 *I_{sat}: Rated Current based on Inductance change
 *I_{temp}: Rated Current based on Temperature rise
 *S.R.F.: Self Resonant Frequency

When rated current is applied to the products, inductance will be within ±30% of initial inductance value range. When rated current is applied to the products, the temperature rise caused by self-generated heat shall be limited to 40°C max. Keep the temperature (ambient temperature plus self-generation of heat) under 125°C.

Inductance-Frequency Characteristics (Typ.)



Inductance-Current Characteristics (Typ.)



Temperature Rise Characteristics (Typ.)



LQM2MPN_EH Series 0806 (2016) inch (mm)



(in mm)

Packaging Code	Packaging	Minimum Quantity
L	ø180mm Embossed Taping	3000
B	Packing in Bulk	1000

Part Number (□: packaging code)	Inductance	Inductance Test Frequency	Rated Current (Isat)*	Rated Current (Itemp)*	DC Resistance	S.R.F.* (min.)
LQM2MPNR24MEH□	0.24μH ±20%	1MHz	4.1A(Max) / 4.5A(Typ.)	2.6A(Max) / 3.3A(Typ.)	0.035Ω(typ.)	130MHz
LQM2MPNR47MEH□	0.47μH ±20%	1MHz	2.3A(Max) / 2.5A(Typ.)	2.15A(Max) / 2.8A(Typ.)	0.05Ω(typ.)	80MHz
LQM2MPNR68MEH□	0.68μH ±20%	1MHz	2.0A(Max) / 2.2A(Typ.)	1.75A(Max) / 2.3A(Typ.)	0.075Ω(typ.)	60MHz
LQM2MPN1ROMEH□	1.0μH ±20%	1MHz	1.8A(Max) / 2.0A(Typ.)	1.5A(Max) / 2.0A(Typ.)	0.1Ω(typ.)	50MHz
LQM2MPN1R5MEH□	1.5μH ±20%	1MHz	0.75A(Max) / 0.9A(Typ.)	1.6A(Max) / 2.1A(Typ.)	0.09Ω(typ.)	40MHz
LQM2MPN2R2MEH□	2.2μH ±20%	1MHz	0.7A(Max) / 0.85A(Typ.)	1.1A(Max) / 1.45A(Typ.)	0.18Ω(typ.)	30MHz

Operating temp. range: -40 to 85°C

Class of Magnetic Shield: Ferrite Core

Only for reflow soldering

*Isat: Rated Current based on Inductance change

*Itemp: Rated Current based on Temperature rise

*S.R.F.: Self Resonant Frequency

When rated current is applied to the products, inductance will be within ±30% of initial inductance value range. When rated current is applied to the products, the temperature rise caused by self-generated heat shall be limited to 40°C max. Keep the temperature (ambient temperature plus self-generation of heat) under 125°C.

Inductance-Frequency Characteristics (Typ.)



Inductance-Current Characteristics (Typ.)



Temperature Rise Characteristics (Typ.)



LQM2MPN_GO Series 0806 (2016) inch (mm)



(in mm)

Packaging Code	Packaging	Minimum Quantity
L	ø180mm Embossed Taping	3000
B	Packing in Bulk	1000

Continued on the following page. ↗

Continued from the preceding page. ↘

Part Number (□: packaging code)	Inductance	Inductance Test Frequency	Rated Current	DC Resistance	S.R.F.* (min.)
LQM2MPNR47MG0□	0.47μH ±20%	1MHz	1.6A(Ambient temp.85°C) 1.2A(Ambient temp.125°C)	0.060Ω(typ.)	100MHz
LQM2MPNR47NG0□	0.47μH ±30%	1MHz	1.6A(Ambient temp.85°C) 1.2A(Ambient temp.125°C)	0.060Ω(typ.)	100MHz
LQM2MPN1R0NG0□	1.0μH ±30%	1MHz	1.4A(Ambient temp.85°C) 1.0A(Ambient temp.125°C)	0.085Ω(typ.)	60MHz
LQM2MPN1R5MG0□	1.5μH ±20%	1MHz	1.2A(Ambient temp.85°C) 0.9A(Ambient temp.125°C)	0.11Ω(typ.)	50MHz
LQM2MPN1R5NG0□	1.5μH ±30%	1MHz	1.2A(Ambient temp.85°C) 0.9A(Ambient temp.125°C)	0.11Ω(typ.)	50MHz
LQM2MPN2R2MG0□	2.2μH ±20%	1MHz	1.2A(Ambient temp.85°C) 0.9A(Ambient temp.125°C)	0.11Ω(typ.)	40MHz
LQM2MPN2R2NG0□	2.2μH ±30%	1MHz	1.2A(Ambient temp.85°C) 0.9A(Ambient temp.125°C)	0.11Ω(typ.)	40MHz
LQM2MPN3R3NG0□	3.3μH ±30%	1MHz	1.2A(Ambient temp.85°C) 0.9A(Ambient temp.125°C)	0.12Ω(typ.)	30MHz
LQM2MPN4R7MG0□	4.7μH ±20%	1MHz	1.1A(Ambient temp.85°C) 0.8A(Ambient temp.125°C)	0.14Ω(typ.)	20MHz
LQM2MPN4R7NG0□	4.7μH ±30%	1MHz	1.1A(Ambient temp.85°C) 0.8A(Ambient temp.125°C)	0.14Ω(typ.)	20MHz

Operating temp. range: -55 to 125°C
 Class of Magnetic Shield: Ferrite Core
 *S.R.F.: Self Resonant Frequency

In operating temperatures exceeding +85°C, derating of current is necessary for the LQM2MPN_G0 series. Please apply the derating curve shown in the chart according to the operating temperature. Please consider "Notice (Rating)." When rated current is applied to the products, the temperature rise caused by self-generated heat shall be limited to 40°C max.

Inductance-Frequency Characteristics (Typ.)



Inductance-Current Characteristics (Typ.)



Temperature Rise Characteristics (Typ.)



Notice (Rating)

In operating temperatures exceeding +85°C, derating of current is necessary for this series. Please apply the derating curve shown in the chart according to the operating temperature.

Derating of Rated Current



LQM2MPN_GH Series 0806 (2016) inch (mm)



Packaging Code	Packaging	Minimum Quantity
L	ø180mm Embossed Taping	3000
B	Packing in Bulk	1000

Part Number (□: packaging code)	Inductance	Inductance Test Frequency	Rated Current (Isat)*	Rated Current (Itemp)*	DC Resistance	S.R.F.* (min.)
LQM2MPNR16MGH□	0.16μH ±20%	1MHz	5.0A(Max) / 5.5A(Typ.)	4.0A(Max) / 5.0A(Typ.)	0.014Ω(typ.)	150MHz
LQM2MPNR24MGH□	0.24μH ±20%	1MHz	4.8A(Max) / 5.0A(Typ.)	3.4A(Max) / 4.4A(Typ.)	0.02Ω(typ.)	130MHz
LQM2MPNR33MGH□	0.33μH ±20%	1MHz	3.7A(Max) / 3.9A(Typ.)	3.1A(Max) / 4.0A(Typ.)	0.024Ω(typ.)	90MHz
LQM2MPNR47MGH□	0.47μH ±20%	1MHz	3.4A(Max) / 3.6A(Typ.)	2.5A(Max) / 3.2A(Typ.)	0.037Ω(typ.)	80MHz
LQM2MPNR68MGH□	0.68μH ±20%	1MHz	3.1A(Max) / 3.4A(Typ.)	1.9A(Max) / 2.5A(Typ.)	0.055Ω(typ.)	60MHz
LQM2MPN1R0MGH□	1.0μH ±20%	1MHz	2.0A(Max) / 2.3A(Typ.)	1.9A(Max) / 2.4A(Typ.)	0.064Ω(typ.)	60MHz
LQM2MPN1R5MGH□	1.5μH ±20%	1MHz	1.8A(Max) / 2.0A(Typ.)	1.5A(Max) / 1.9A(Typ.)	0.104Ω(typ.)	50MHz
LQM2MPN2R2MGH□	2.2μH ±20%	1MHz	1.3A(Max) / 1.5A(Typ.)	1.0A(Max) / 1.3A(Typ.)	0.21Ω(typ.)	40MHz

Operating temp. range: -40 to 85°C
 Class of Magnetic Shield: Ferrite Core
 Only for reflow soldering

*Isat: Rated Current based on Inductance change
 *Itemp: Rated Current based on Temperature rise
 *S.R.F.: Self Resonant Frequency

When rated current is applied to the products, inductance will be within ±30% of initial inductance value range. When rated current is applied to the products, the temperature rise caused by self-generated heat shall be limited to 40°C max. Keep the temperature (ambient temperature plus self-generation of heat) under 125°C.

Inductance-Frequency Characteristics (Typ.)



Inductance-Current Characteristics (Typ.)



Temperature Rise Characteristics (Typ.)



LQM2HPN_CH Series 1008 (2520) inch (mm)



Packaging Code	Packaging	Minimum Quantity
K	ø330mm Embossed Taping	10000
L	ø180mm Embossed Taping	3000
B	Packing in Bulk	1000

Continued on the following page. ↗

Continued from the preceding page. ↘

Part Number (□: packaging code)	Inductance	Inductance Test Frequency	Rated Current (Isat)*	Rated Current (Itemp)*	DC Resistance	S.R.F.* (min.)
LQM2HPNR24MCH□	0.24μH ±20%	1MHz	2.55A(Max.) / 3A(Typ.)	2.2A(Max.) / 2.7A(Typ.)	0.055Ω(typ.)	130MHz
LQM2HPNR47MCH□	0.47μH ±20%	1MHz	1.66A(Max.) / 1.95A(Typ.)	1.5A(Max.) / 1.9A(Typ.)	0.115Ω(typ.)	80MHz
LQM2HPNR68MCH□	0.68μH ±20%	1MHz	1.1A(Max.) / 1.3A(Typ.)	1.5A(Max.) / 1.8A(Typ.)	0.12Ω(typ.)	60MHz
LQM2HPN1R0MCH□	1.0μH ±20%	1MHz	0.6A(Max.) / 0.7A(Typ.)	1.7A(Max.) / 2.1A(Typ.)	0.08Ω(typ.)	50MHz
LQM2HPN1R5MCH□	1.5μH ±20%	1MHz	0.6A(Max.) / 0.7A(Typ.)	0.95A(Max.) / 1.1A(Typ.)	0.285Ω(typ.)	40MHz
LQM2HPN2R2MCH□	2.2μH ±20%	1MHz	0.43A(Max.) / 0.5A(Typ.)	0.85A(Max.) / 1.05A(Typ.)	0.355Ω(typ.)	30MHz

Operating temp. range: -40 to 85°C

Class of Magnetic Shield: Ferrite Core

Only for reflow soldering

*Isat: Rated Current based on Inductance change

*Itemp: Rated Current based on Temperature rise

*S.R.F.: Self Resonant Frequency

When rated current is applied to the products, inductance will be within ±30% of initial inductance value range. When rated current is applied to the products, the temperature rise caused by self-generated heat shall be limited to 40°C max. Keep the temperature (ambient temperature plus self-generation of heat) under 125°C.

Inductance-Frequency Characteristics (Typ.)



Inductance-Current Characteristics (Typ.)



Temperature Rise Characteristics (Typ.)



LQM2HPN_E0 Series 1008 (2520) inch (mm)



(in mm)

Packaging Code	Packaging	Minimum Quantity
L	ø180mm Embossed Taping	3000
B	Packing in Bulk	1000

Part Number (□: packaging code)	Inductance	Inductance Test Frequency	Rated Current	DC Resistance	S.R.F.* (min.)
LQM2HPNR56ME0□	0.56μH ±20%	1MHz	1500mA	0.06Ω±25%	70MHz

Operating temp. range: -55 to 125°C

Class of Magnetic Shield: Ferrite Core

*S.R.F.: Self Resonant Frequency

Continued on the following page. ↗

Continued from the preceding page. ↘

Inductance-Frequency Characteristics (Typ.)



Inductance-Current Characteristics (Typ.)



Temperature Rise Characteristics (Typ.)



LQM2HPN_EH Series 1008 (2520) inch (mm)



(in mm)

Packaging Code	Packaging	Minimum Quantity
L	ø180mm Embossed Taping	3000
B	Packing in Bulk	1000

Part Number (□: packaging code)	Inductance	Inductance Test Frequency	Rated Current (I _{sat})*	Rated Current (I _{temp})*	DC Resistance	S.R.F.* (min.)
LQM2HPNR24MEH□	0.24μH ±20%	1MHz	4.5A(Max) / 5.0A(Typ.)	3.0A(Max) / 3.8A(Typ.)	0.027Ω(typ.)	130MHz
LQM2HPNR47MEH□	0.47μH ±20%	1MHz	4.0A(Max) / 4.3A(Typ.)	2.2A(Max) / 2.6A(Typ.)	0.055Ω(typ.)	80MHz
LQM2HPNR68MEH□	0.68μH ±20%	1MHz	2.1A(Max) / 2.3A(Typ.)	1.85A(Max) / 2.3A(Typ.)	0.075Ω(typ.)	60MHz
LQM2HPN1R0MEH□	1.0μH ±20%	1MHz	1.9A(Max) / 2.1A(Typ.)	1.65A(Max) / 2.0A(Typ.)	0.095Ω(typ.)	50MHz
LQM2HPN1R5MEH□	1.5μH ±20%	1MHz	1.2A(Max) / 1.4A(Typ.)	1.45A(Max) / 1.8A(Typ.)	0.12Ω(typ.)	40MHz
LQM2HPN2R2MEH□	2.2μH ±20%	1MHz	0.8A(Max) / 1.0A(Typ.)	1.3A(Max) / 1.7A(Typ.)	0.15Ω(typ.)	30MHz

Operating temp. range: -40 to 85°C

Class of Magnetic Shield: Ferrite Core

Only for reflow soldering

*I_{sat}: Rated Current based on Inductance change

*I_{temp}: Rated Current based on Temperature rise

*S.R.F.: Self Resonant Frequency

When rated current is applied to the products, inductance will be within ±30% of initial inductance value range. When rated current is applied to the products, the temperature rise caused by self-generated heat shall be limited to 40°C max. Keep the temperature (ambient temperature plus self-generation of heat) under 125°C.

Inductance-Frequency Characteristics (Typ.)



Inductance-Current Characteristics (Typ.)



Temperature Rise Characteristics (Typ.)



LQM2HPN_G0 Series 1008 (2520) inch (mm)



Packaging Code	Packaging	Minimum Quantity
L	ø180mm Embossed Taping	3000
B	Packing in Bulk	1000

Part Number (□: packaging code)	Inductance	Inductance Test Frequency	Rated Current	DC Resistance	S.R.F.* (min.)
LQM2HPNR47MG0□	0.47μH ±20%	1MHz	1.8A(Ambient temp.85°C) 1.3A(Ambient temp.125°C)	0.040Ω(typ.)	100MHz
LQM2HPN1R0MG0□	1.0μH ±20%	1MHz	1.6A(Ambient temp.85°C) 1.2A(Ambient temp.125°C)	0.055Ω(typ.)	60MHz
LQM2HPN1R5MG0□	1.5μH ±20%	1MHz	1.5A(Ambient temp.85°C) 1.1A(Ambient temp.125°C)	0.070Ω(typ.)	50MHz
LQM2HPN2R2MG0□	2.2μH ±20%	1MHz	1.3A(Ambient temp.85°C) 0.97A(Ambient temp.125°C)	0.080Ω(typ.)	40MHz
LQM2HPN3R3MG0□	3.3μH ±20%	1MHz	1.2A(Ambient temp.85°C) 0.9A(Ambient temp.125°C)	0.10Ω(typ.)	30MHz
LQM2HPN4R7MG0□	4.7μH ±20%	1MHz	1.1A(Ambient temp.85°C) 0.82A(Ambient temp.125°C)	0.11Ω(typ.)	25MHz

Operating temp. range: -55 to 125°C
 Class of Magnetic Shield: Ferrite Core

*S.R.F.: Self Resonant Frequency

In operating temperatures exceeding +85°C, derating of current is necessary for the LQM2HP_G0 series. Please apply the derating curve shown in the chart according to the operating temperature. Please consider "Notice (Rating)." When rated current is applied to the products, the temperature rise caused by self-generated heat shall be limited to 40°C max.

Inductance-Frequency Characteristics (Typ.)



Inductance-Current Characteristics (Typ.)



Temperature Rise Characteristics (Typ.)



Notice (Rating)

In operating temperatures exceeding +85°C, derating of current is necessary for this series. Please apply the derating curve shown in the chart according to the operating temperature.

Derating of Rated Current



LQM2HPN_G0
Inductors for Power Lines

Inductors for General Circuits

RF Inductors

LQM2HPN_GC Series 1008 (2520) inch (mm)



Packaging Code	Packaging	Minimum Quantity
L	ø180mm Embossed Taping	3000
B	Packing in Bulk	1000

Part Number (□: packaging code)	Inductance	Inductance Test Frequency	Rated Current	DC Resistance	S.R.F.* (min.)	Operating temp. range
LQM2HPN1R0MGC□	1.0μH ±20%	1MHz	1500mA	0.08Ω±25%	50MHz	-30 to 85°C
LQM2HPN3R3MGC□	3.3μH ±20%	1MHz	1000mA	0.16Ω±25%	30MHz	-55 to 125°C
LQM2HPN4R7MGC□	4.7μH ±20%	1MHz	800mA	0.18Ω±25%	25MHz	-55 to 125°C

Class of Magnetic Shield: Ferrite Core
 *S.R.F.: Self Resonant Frequency

Inductance-Frequency Characteristics (Typ.)



Inductance-Current Characteristics (Typ.)



Temperature Rise Characteristics (Typ.)



LQM2HPN_GH Series 1008 (2520) inch (mm)



Packaging Code	Packaging	Minimum Quantity
L	ø180mm Embossed Taping	3000
B	Packing in Bulk	1000

Continued on the following page. ↗

Continued from the preceding page. ↘

Part Number (□: packaging code)	Inductance	Inductance Test Frequency	Rated Current (Isat)*	Rated Current (Itemp)*	DC Resistance	S.R.F.* (min.)
LQM2HPNR24MGH□	0.24μH ±20%	1MHz	4.5A(Max) / 5.7A(Typ.)	3.3A(Max) / 4.2A(Typ.)	0.024Ω(typ.)	80MHz
LQM2HPNR33MGH□	0.33μH ±20%	1MHz	5A(Max) / 5.3A(Typ.)	3A(Max) / 4A(Typ.)	0.03Ω(typ.)	80MHz
LQM2HPNR47MGH□	0.47μH ±20%	1MHz	4.5A(Max) / 4.8A(Typ.)	2.6A(Max) / 3.3A(Typ.)	0.04Ω(typ.)	80MHz
LQM2HPNR68MGH□	0.68μH ±20%	1MHz	3.8A(Max) / 4.0A(Typ.)	2.3A(Max) / 2.9A(Typ.)	0.05Ω(typ.)	60MHz
LQM2HPN1R0MGH□	1.0μH ±20%	1MHz	2.0A(Max) / 2.3A(Typ.)	2.3A(Max) / 2.9A(Typ.)	0.05Ω(typ.)	50MHz
LQM2HPN1R5MGH□	1.5μH ±20%	1MHz	1.5A(Max) / 1.6A(Typ.)	2.0A(Max) / 2.6A(Typ.)	0.065Ω(typ.)	40MHz
LQM2HPN2R2MGH□	2.2μH ±20%	1MHz	1.5A(Max) / 1.6A(Typ.)	1.5A(Max) / 1.9A(Typ.)	0.11Ω(typ.)	30MHz

Operating temp. range: -40 to 85°C

Class of Magnetic Shield: Ferrite Core

Only for reflow soldering

*Isat: Rated Current based on Inductance change

*Itemp: Rated Current based on Temperature rise

*S.R.F.: Self Resonant Frequency

When rated current is applied to the products, inductance will be within ±30% of initial inductance value range. When rated current is applied to the products, the temperature rise caused by self-generated heat shall be limited to 40°C max. Keep the temperature (ambient temperature plus self-generation of heat) under 125°C.

Inductance-Frequency Characteristics (Typ.)



Inductance-Current Characteristics (Typ.)



Temperature Rise Characteristics (Typ.)



LQM2HPN_GS Series 1008 (2520) inch (mm)



(in mm)

Packaging Code	Packaging	Minimum Quantity
L	ø180mm Embossed Taping	3000
B	Packing in Bulk	1000

Part Number (□: packaging code)	Inductance	Inductance Test Frequency	Rated Current	DC Resistance	S.R.F.* (min.)
LQM2HPN2R2MGS□	2.2μH ±20%	1MHz	1100mA	0.18Ω±25%	40MHz
LQM2HPN3R3MGS□	3.3μH ±20%	1MHz	1050mA	0.21Ω±25%	20MHz
LQM2HPN4R7MGS□	4.7μH ±20%	1MHz	1000mA	0.25Ω±25%	20MHz

Operating temp. range: -40 to 85°C

Class of Magnetic Shield: Ferrite Core

*S.R.F.: Self Resonant Frequency

Continued on the following page. ↗

Continued from the preceding page. ↘

Inductance-Frequency Characteristics (Typ.)



Inductance-Current Characteristics (Typ.)



Temperature Rise Characteristics (Typ.)

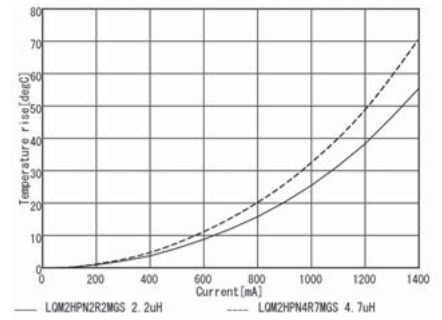

LQM2HPN_J0 Series 1008 (2520) inch (mm)



Packaging Code	Packaging	Minimum Quantity
L	ø180mm Embossed Taping	3000
B	Packing in Bulk	1000

Part Number (□: packaging code)	Inductance	Inductance Test Frequency	Rated Current	DC Resistance	S.R.F.* (min.)
LQM2HPN1R0MJ0□	1.0μH ±20%	1MHz	1500mA	0.09Ω±25%	70MHz
LQM2HPN2R2MJ0□	2.2μH ±20%	1MHz	1000mA	0.12Ω±25%	40MHz
LQM2HPN3R3MJ0□	3.3μH ±20%	1MHz	1000mA	0.12Ω±25%	30MHz

Operating temp. range: -55 to 125°C
 Class of Magnetic Shield: Ferrite Core
 *S.R.F.: Self Resonant Frequency

Inductance-Frequency Characteristics (Typ.)



Inductance-Current Characteristics (Typ.)



Temperature Rise Characteristics (Typ.)

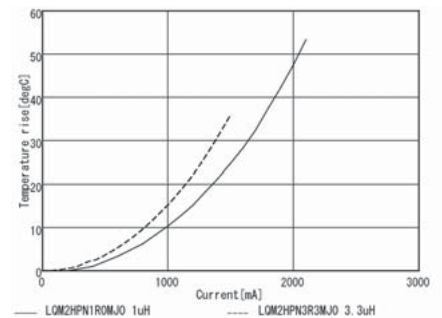

LQM2HPN_JH Series 1008 (2520) inch (mm)



Packaging Code	Packaging	Minimum Quantity
L	ø180mm Embossed Taping	3000
B	Packing in Bulk	1000

(in mm)

Part Number (□: packaging code)	Inductance	Inductance Test Frequency	Rated Current (I _{sat})*	Rated Current (I _{temp})*	DC Resistance	S.R.F.* (min.)
LQM2HPNR47MJH□	0.47μH ±20%	1MHz	3.2A(Max) / 3.5A(Typ.)	2.7A(Max) / 3.4A(Typ.)	0.037Ω(typ.)	70MHz
LQM2HPN1R0MJH□	1.0μH ±20%	1MHz	2.1A(Max) / 2.4A(Typ.)	2.3A(Max) / 2.9A(Typ.)	0.05Ω(typ.)	50MHz
LQM2HPN2R2MJH□	2.2μH ±20%	1MHz	1.4A(Max) / 1.6A(Typ.)	1.5A(Max) / 1.9A(Typ.)	0.11Ω(typ.)	30MHz

Operating temp. range: -40 to 85°C

Class of Magnetic Shield: Ferrite Core

Only for reflow soldering

*I_{sat}: Rated Current based on Inductance change

*I_{temp}: Rated Current based on Temperature rise

*S.R.F.: Self Resonant Frequency

When rated current is applied to the products, inductance will be within ±30% of initial inductance value. When rated current is applied to the products, the temperature rise caused by self-heating will be 40°C or less. Keep the temperature of product (ambient temperature plus self-generation of heat) under 125°C.

Inductance-Frequency Characteristics (Typ.)



Inductance-Current Characteristics (Typ.)



Temperature Rise Characteristics (Typ.)



LQM31PN_00 Series 1206 (3216) inch (mm)



Packaging Code	Packaging	Minimum Quantity
L	ø180mm Embossed Taping	3000
B	Packing in Bulk	1000

(in mm)

Continued on the following page. ↗

Continued from the preceding page. ↘

Part Number (□: packaging code)	Inductance	Inductance Test Frequency	Rated Current	DC Resistance	S.R.F.* (min.)
LQM31PNR47M00□	0.47μH ±20%	1MHz	1400mA	0.07Ω±25%	80MHz
LQM31PN1R0M00□	1.0μH ±20%	1MHz	1200mA	0.12Ω±25%	60MHz
LQM31PN1R5M00□	1.5μH ±20%	1MHz	1000mA	0.14Ω±25%	50MHz
LQM31PN2R2M00□	2.2μH ±20%	1MHz	900mA	0.19Ω±25%	40MHz
LQM31PN3R3M00□	3.3μH ±20%	1MHz	800mA	0.24Ω±25%	30MHz
LQM31PN4R7M00□	4.7μH ±20%	1MHz	700mA	0.30Ω±25%	25MHz

Operating temp. range: -55 to 125°C
 Class of Magnetic Shield: Ferrite Core
 *S.R.F.: Self Resonant Frequency

Inductance-Frequency Characteristics (Typ.)



Inductance-Current Characteristics (Typ.)



Temperature Rise Characteristics (Typ.)



LQM32PN_G0 Series 1210 (3225) inch (mm)



Packaging Code	Packaging	Minimum Quantity
L	ø180mm Embossed Taping	3000
B	Packing in Bulk	1000

Part Number (□: packaging code)	Inductance	Inductance Test Frequency	Rated Current	DC Resistance	S.R.F.* (min.)
LQM32PN1R0MG0□	1.0μH ±20%	1MHz	1800mA	0.048Ω±25%	40MHz

Operating temp. range: -40 to 85°C
 Class of Magnetic Shield: Ferrite Core
 Only for reflow soldering
 *S.R.F.: Self Resonant Frequency

Inductance-Frequency Characteristics (Typ.)



Inductance-Current Characteristics (Typ.)



Temperature Rise Characteristics (Typ.)



LQM32PN_GC Series 1210 (3225) inch (mm)



(in mm)

Packaging Code	Packaging	Minimum Quantity
L	ø180mm Embossed Taping	3000
B	Packing in Bulk	1000

Part Number (□: packaging code)	Inductance	Inductance Test Frequency	Rated Current (I _{sat})*	Rated Current (I _{temp})*	DC Resistance	S.R.F.* (min.)
LQM32PN1R0MGC□	1.0μH ±20%	1MHz	2.2A(Max.) / 2.9A(Typ.)	1.8A(Max.) / 2.4A(Typ.)	0.043Ω(Typ.)	60MHz

Operating temp. range: -40 to 85°C

Class of Magnetic Shield: Ferrite Core

Only for reflow soldering

*I_{sat}: Rated Current based on Inductance change

*I_{temp}: Rated Current based on Temperature rise

*S.R.F.: Self Resonant Frequency

When rated current is applied to the products, inductance will be within ±30% of initial inductance value. When rated current is applied to the products, the temperature rise caused by self-heating will be 40°C or less. Keep the temperature of product (ambient temperature plus self-generation of heat) under 125°C.

Inductance-Frequency Characteristics (Typ.)



Inductance-Current Characteristics (Typ.)



Temperature Rise Characteristics (Typ.)



LQM32PN_GC

Inductors for Power Lines

Inductors for General Circuits

RF Inductors

Inductors for Power Lines ⚠️Caution/Notice

⚠️Caution

Rating

1. About the Rated Current

Do not use products beyond the rated current as this may create excessive heat and deteriorate the insulation resistance.

Be sure to provide an appropriate fail-safe function on your product to prevent a second damage that may be caused by the abnormal function or the failure of our product.

2. About Excessive Surge Current

Surge current (pulse current or rush current) greater than the specified rated current applied to the product may cause a critical failure, such as an open circuit or burnout caused by excessive temperature rise.

Please contact us in advance if applying a surge current.

Notice

Storage and Operating Condition

<Operating Environment>

Do not use products in a chemical atmosphere such as chlorine gas, acid or sulfide gas.

<Storage Requirements>

1. Storage Period

The LQB/LQG/LQH/LQP/LQW series should be used within 12 months; the other products should be used within 6 months.

Check solderability if this period is exceeded.

2. Storage Conditions

(1) Store products in a warehouse in compliance with the following conditions:

Temperature: -10 to +40°C.

Humidity: 15 to 85% (relative humidity)

Do not subject products to rapid changes in temperature and humidity.

Do not store them in a chemical atmosphere such as one containing sulfurous acid gas, alkaline gas or acid. This will prevent electrode oxidation, which causes poor solderability and possible corrosion of inductors.

(2) Do not store products in bulk packaging to prevent collision among inductors, which causes core chipping and wire breakage.

(3) Store products on pallets to protect from humidity, dust, etc.

(4) Avoid heat shock, vibration, direct sunlight, etc.

Handling

This item is designed to have sufficient strength, but handle with care to avoid chipping or breaking its ceramic structure.

LQW15D series

- To prevent breaking the wire, avoid touching with sharp materials, such as tweezers or other materials such as the bristles of a cleaning brush, to the wire wound portion.
- To prevent breaking the core, avoid applying excessive mechanical shock to products mounted on the board.
- In some mounting machines, when picking up components, a support pin pushes the components up from the bottom of the base tape. In this case, please remove the support pin. The support pin may damage the components and break the wire.
- The product temperature rises about 40°C maximum when the permissible current is applied to LQW15D. Please use caution regarding the temperature of the substrate and air around the part.

LQH_C/D/H/M/N/P series

- To prevent breaking the wire, avoid touching with sharp materials, such as tweezers or the bristles of a cleaning brush, to the wire wound portion of this product.
- To prevent breaking the core, avoid applying excessive mechanical shock to products mounted on the board.
- Temperature may rise up to max. 40°C when applying the rated current to Inductors for Power Lines. Use caution regarding the temperature rating of the circuit board and components around the products.
- Metal alloy inductor product*
Metal alloy inductor product* employs a core with low insulation resistance, pay strict attention when use it.
 - a) Do not make any through holes and copper pattern under the coil. except a copper pattern to the electrode.
 - b) Design/mount any components not to contact this product.

*Regarding Metal alloy inductor product, please refer to Product Guide in the page 2 to 5.

Continued on the following page. ↗

Inductors for Power Lines ⚠Caution/Notice

Continued from the preceding page. ↘

LQM series

- There is the possibility that magnetism may change the inductance value. Do not use a magnet or tweezers with magnetism when handling products. (The tip of the tweezers should be molded with resin or pottery.)
- When the excessive current over rated current is applied, it may cause the inductance value to change due to magnetism.

<Transportation>

Do not apply excessive vibration or mechanical shock to products.

<Resin Coating>

When coating products with resin, the relatively high resin curing stress may change inductance values.

For exterior coating, select resin carefully so that electrical and mechanical performance of the product is not affected. Prior to use, please evaluate reliability with the product mounted in your application set.

- LQW15D, LQH2HPN_DR series

An open circuit issue may occur by mechanical stress caused by the resin, amount/cured shape of resin, or operating conditions, etc. Some resins containing impurities or chloride may possibly generate chlorine by hydrolysis under some operating conditions, causing corrosion of the inductor wire and leading to an open circuit.

<Handling of a Substrate>

After mounting products on a substrate, do not apply any stress to the product caused by bending or twisting the substrate when cropping the substrate, inserting and removing a connector from the substrate, or tightening a screw to the substrate.

Excessive mechanical stress may cause cracking in the Product.

Bending



Twisting



Inductors for Power Lines Soldering and Mounting

1. Standard Land Pattern Dimensions

Land Pattern + Solder Resist
 Land Pattern
 Solder Resist
 (in mm)

Series	Standard Land Dimensions						
LQM18F/18P (Except for LQM18P_CH/FH/GH) LQM21D/21F/21P (Except for LQM21P_CA/CH/EH/GH) LQM2MP (Except for LQM2MP_EH/GH) LQM2HP (Except for LQM2HP_CH/EH/GH/JH) LQM31P LQM32P LQH2M LQH31C LQH32P LQH44P_PO/J0/GR LQH5BP LQH55D/66S LQW15CN_00 LQW15C_10 LQW15DN LQW18C		Part Number		a	b	c	d
		LQM18F/18P	Flow	0.7	2.2-2.6	0.7	-
			Reflow				
		LQM21D/21F/21P		1.2	3.0-4.0	1.0	-
		LQM2MP		0.8	2.4	1.8	-
		LQM2HP		1.6	3.0	1.5	-
		LQM31P		2.0	4.2-5.2	1.2	-
		LQM32P		1.9	3.6	2.7	-
		LQH2M		0.8	2.6	1.0	-
		LQH31C		1.0	4.5	1.5	-
		LQH32P		1.3	3.8	2.0	-
		LQH44P_PO		1.3	4.4	3.0	1.55
		LQH44P_J0/GR		1.5	4.4	2.7	1.45
		LQH5BP		1.8	5.5	4.1	1.85
		LQH55D/66S		2.0	8.0	3.5	3.0
		LQW15CN_00		0.4	1.4	0.6	-
		LQW15C_10/LQW15DN		0.4	1.4	0.66	-
		LQW18C		0.7	2.2	1.0	-

Series	Part Number	Rated Current (A)	a	b	c	Land Pad Thickness and Dimension d			
						18μm	35μm	70μm	
						LQM18P_CH	0-0.7 0.7-1.05	0.7	1.8-2.0
LQM18P_FH	0-0.7 0.7-1.7	0.7	1.8-2.0	0.7	0.7	0.7			
LQM18P_GH	0-0.7 0.7-1.15	0.7	1.8-2.0	0.7	0.7	0.7	0.7		
LQM21P_CA	0-1.3				1.2	3.0-4.0	1.0	1.3	1.0
LQM21P_CH	0-1.0 1.0-1.5 1.5-	1.2	3.0-4.0	1.0	1.0	1.0	1.0		
LQM21P_EH LQM21P_GH	0-1.0 1.0-1.5 1.5-3.1				1.2	3.0-4.0	1.0	1.0	1.0
LQM2MP_EH	0-1.5 1.5-2.5 2.5-4.5				0.8	2.4	1.8	1.8	1.8
LQM2MP_GH	0-1.5 1.5-2.5 2.5-5.0	0.8	2.4	1.8	1.8	1.8	1.8		
LQM2HP_CH	0-1.5 1.5-3.0				1.6	3.0	1.5	1.5	1.5
LQM2HP_EH	0-1.5 1.5-3.0 3.0-5.0				1.6	3.0	1.5	1.5	1.5
LQM2HP_GH	0-1.5 1.5-2.6 3.3-4.2	1.6	3.0	1.5	1.5	1.5	1.5		
LQM2HP_JH	0-1.6 1.6-2.4 2.4-3.5				1.6	3.0	1.5	1.5	1.5



Attention should be paid to potential magnetic coupling effects when using the Inductor (coil) as a resonator.

Continued on the following page. ↗

Inductors for Power Lines Soldering and Mounting

Continued from the preceding page. ↘

Land Pattern + Solder Resist
 Land Pattern
 Solder Resist
 (in mm)

Series	Standard Land Dimensions				
D52LC D53LC D63LCB DEM3512C DEM3518C DEM4518C DFE18SAN_EO DFE18SAN_GO DFE18SBN_EO DFE201208S DFE201210S DFE201210U DFE201610C DFE201610E DFE201610P DFE201610R DFE201612C DFE201612E DFE201612P DFE201612R DFE252007F DFE252008C DFE252008U DFE252010C DFE252010F DFE252010P DFE252010R DFE252012C DFE252012F DFE252012P DFE252012R DFE322510C DFE322512C DFE322512F DS104C2 DS106C2 DS126C2 DS75LC FCUL0530 FDSD0412 FDSD0415 FDSD0420 FDSD0420W LQH2HP_DR LQH2HP_GR/JR LQH3NP_JR/GR/ME		Part Number	a	b	c
		D52LC	4.0	6.0	2.0
		D53LC	4.0	6.0	2.0
		D63LCB	4.6	6.6	2.6
		DEM3512C	2.3	4.3	1.4
		DEM3518C	2.3	4.3	1.4
		DEM4518C	3.3	5.3	2.2
		DFE18SAN_EO	0.7	1.8	1.0
		DFE18SAN_GO	0.7	1.8	1.0
		DFE18SBN_EO	0.7	1.8	1.0
		DFE201208S	0.8	2.4	1.4
		DFE201210S	0.8	2.4	1.4
		DFE201210U	0.8	2.4	1.4
		DFE201610C	0.8	2.4	1.8
		DFE201610E	0.8	2.4	1.8
		DFE201610P	0.8	2.4	1.8
		DFE201610R	0.8	2.4	1.8
		DFE201612C	0.8	2.4	1.8
		DFE201612E	0.8	2.4	1.8
		DFE201612P	0.8	2.4	1.8
		DFE201612R	0.8	2.4	1.8
		DFE252007F	1.2	2.8	2.0
		DFE252008C	1.2	2.8	2.0
		DFE252008U	1.2	2.8	2.0
		DFE252010C	1.2	2.8	2.0
		DFE252010F	1.2	2.8	2.0
		DFE252010P	1.2	2.8	2.0
		DFE252010R	1.2	2.8	2.0
		DFE252012C	1.2	2.8	2.0
		DFE252012F	1.2	2.8	2.0
		DFE252012P	1.2	2.8	2.0
		DFE252012R	1.2	2.8	2.0
		DFE322510C	1.9	3.7	2.8
		DFE322512C	1.9	3.7	2.8
		DFE322512F	1.9	3.7	2.8
		DS104C2	5.4	10.7	3.6
		DS106C2	5.4	10.7	3.6
		DS126C2	7.9	13.1	3.6
		DS75LC	4.4	8.4	3.0
		FCUL0530	3.4	7.0	2.0
		FDSD0412	1.8	4.6	2.4
		FDSD0415	1.8	4.6	2.4
		FDSD0420	1.8	4.6	2.4
		FDSD0420W	1.8	4.6	2.4
		LQH2HP_DR	0.83	2.5	1.6
		LQH2HP_GR/JR	1.25	2.5	2.0
		LQH3NP_JR/GR/ME	1.4	3.0	2.7

Attention should be paid to potential magnetic coupling effects when using the Inductor (coil) as a resonator.

Continued on the following page. ↗

Inductors for Power Lines

Inductors for General Circuits

RF Inductors

Inductors for Power Lines Soldering and Mounting

Continued from the preceding page. ↘

Land Pattern + Solder Resist
 Land Pattern
 Solder Resist
 (in mm)

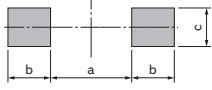
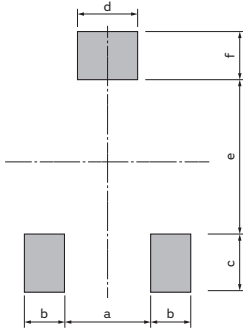
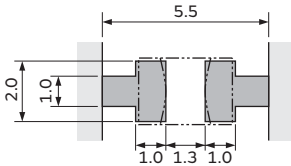
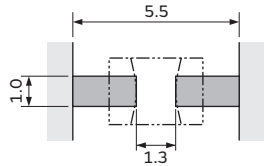
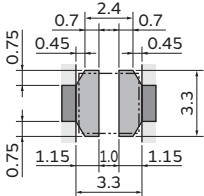
Series	Standard Land Dimensions																																																																																																																																																																																																			
DEM2812C DEM2815C DEM2818C FCUL0624 FCUL0630 FCUL1040 FCUL1060 FDSD0512 FDSD0515 FDSD0518 FDSD0630 FDUE0630 FDUE0640 FDUE0650 FDUE1040D FDUE1245 FDUE1260 FDV0530 FDV0530S FDV0618 FDV0620 FDVE0630 FDVE0640 FDVE1040				<table border="1" style="width: 100%; border-collapse: collapse;"> <thead> <tr> <th style="background-color: #cccccc;">Part Number</th> <th style="background-color: #cccccc;">a</th> <th style="background-color: #cccccc;">b</th> <th style="background-color: #cccccc;">c</th> <th colspan="3"></th> </tr> </thead> <tbody> <tr><td>DEM2812C</td><td>1.8</td><td>0.9</td><td>1.2</td><td colspan="3"></td></tr> <tr><td>DEM2815C</td><td>1.8</td><td>0.9</td><td>1.2</td><td colspan="3"></td></tr> <tr><td>DEM2818C</td><td>1.8</td><td>0.9</td><td>1.2</td><td colspan="3"></td></tr> <tr><td>FCUL0624</td><td>4.0</td><td>2.1</td><td>1.9</td><td colspan="3"></td></tr> <tr><td>FCUL0630</td><td>4.0</td><td>2.1</td><td>1.9</td><td colspan="3"></td></tr> <tr><td>FCUL1040</td><td>6.0</td><td>3.8</td><td>4.9</td><td colspan="3"></td></tr> <tr><td>FCUL1060</td><td>6.0</td><td>3.8</td><td>4.9</td><td colspan="3"></td></tr> <tr><td>FDSD0512</td><td>2.2</td><td>1.7</td><td>2.8</td><td colspan="3"></td></tr> <tr><td>FDSD0515</td><td>2.2</td><td>1.7</td><td>2.8</td><td colspan="3"></td></tr> <tr><td>FDSD0518</td><td>2.2</td><td>1.7</td><td>2.8</td><td colspan="3"></td></tr> <tr><td>FDSD0630</td><td>4.0</td><td>2.0</td><td>3.5</td><td colspan="3"></td></tr> <tr><td>FDUE0630</td><td>4.0</td><td>2.1</td><td>2.5</td><td colspan="3"></td></tr> <tr><td>FDUE0640</td><td>4.0</td><td>2.1</td><td>2.5</td><td colspan="3"></td></tr> <tr><td>FDUE0650</td><td>4.0</td><td>2.1</td><td></td><td>3.2: 0.6μH</td><td colspan="2"></td></tr> <tr><td></td><td></td><td></td><td></td><td>2.9: 1.0μH</td><td colspan="2"></td></tr> <tr><td>FDUE1040D</td><td>6.0</td><td>3.8</td><td>4.6</td><td colspan="3"></td></tr> <tr><td>FDUE1245</td><td>8.0</td><td>3.0</td><td>3.6</td><td colspan="3"></td></tr> <tr><td>FDUE1260</td><td>6.5</td><td>4.6</td><td>4.0</td><td colspan="3"></td></tr> <tr><td>FDV0530</td><td>3.2</td><td>1.8</td><td>3.1</td><td colspan="3"></td></tr> <tr><td>FDV0530S</td><td>2.2</td><td>1.7</td><td>2.8</td><td colspan="3"></td></tr> <tr><td>FDV0618</td><td>4.0</td><td>2.0</td><td>3.5</td><td colspan="3"></td></tr> <tr><td>FDV0620</td><td>4.0</td><td>2.0</td><td>3.5</td><td colspan="3"></td></tr> <tr><td>FDVE0630</td><td>4.0</td><td>2.0</td><td>3.5</td><td colspan="3"></td></tr> <tr><td>FDVE0640</td><td>4.0</td><td>2.0</td><td>3.5</td><td colspan="3"></td></tr> <tr><td>FDVE1040</td><td>6.0</td><td>3.8</td><td>4.0</td><td colspan="3"></td></tr> </tbody> </table>				Part Number	a	b	c				DEM2812C	1.8	0.9	1.2				DEM2815C	1.8	0.9	1.2				DEM2818C	1.8	0.9	1.2				FCUL0624	4.0	2.1	1.9				FCUL0630	4.0	2.1	1.9				FCUL1040	6.0	3.8	4.9				FCUL1060	6.0	3.8	4.9				FDSD0512	2.2	1.7	2.8				FDSD0515	2.2	1.7	2.8				FDSD0518	2.2	1.7	2.8				FDSD0630	4.0	2.0	3.5				FDUE0630	4.0	2.1	2.5				FDUE0640	4.0	2.1	2.5				FDUE0650	4.0	2.1		3.2: 0.6μH							2.9: 1.0μH			FDUE1040D	6.0	3.8	4.6				FDUE1245	8.0	3.0	3.6				FDUE1260	6.5	4.6	4.0				FDV0530	3.2	1.8	3.1				FDV0530S	2.2	1.7	2.8				FDV0618	4.0	2.0	3.5				FDV0620	4.0	2.0	3.5				FDVE0630	4.0	2.0	3.5				FDVE0640	4.0	2.0	3.5				FDVE1040	6.0	3.8	4.0										
	Part Number	a	b	c																																																																																																																																																																																																
	DEM2812C	1.8	0.9	1.2																																																																																																																																																																																																
	DEM2815C	1.8	0.9	1.2																																																																																																																																																																																																
	DEM2818C	1.8	0.9	1.2																																																																																																																																																																																																
	FCUL0624	4.0	2.1	1.9																																																																																																																																																																																																
	FCUL0630	4.0	2.1	1.9																																																																																																																																																																																																
	FCUL1040	6.0	3.8	4.9																																																																																																																																																																																																
	FCUL1060	6.0	3.8	4.9																																																																																																																																																																																																
	FDSD0512	2.2	1.7	2.8																																																																																																																																																																																																
	FDSD0515	2.2	1.7	2.8																																																																																																																																																																																																
	FDSD0518	2.2	1.7	2.8																																																																																																																																																																																																
	FDSD0630	4.0	2.0	3.5																																																																																																																																																																																																
	FDUE0630	4.0	2.1	2.5																																																																																																																																																																																																
	FDUE0640	4.0	2.1	2.5																																																																																																																																																																																																
	FDUE0650	4.0	2.1		3.2: 0.6μH																																																																																																																																																																																															
					2.9: 1.0μH																																																																																																																																																																																															
	FDUE1040D	6.0	3.8	4.6																																																																																																																																																																																																
	FDUE1245	8.0	3.0	3.6																																																																																																																																																																																																
	FDUE1260	6.5	4.6	4.0																																																																																																																																																																																																
	FDV0530	3.2	1.8	3.1																																																																																																																																																																																																
	FDV0530S	2.2	1.7	2.8																																																																																																																																																																																																
	FDV0618	4.0	2.0	3.5																																																																																																																																																																																																
	FDV0620	4.0	2.0	3.5																																																																																																																																																																																																
	FDVE0630	4.0	2.0	3.5																																																																																																																																																																																																
	FDVE0640	4.0	2.0	3.5																																																																																																																																																																																																
	FDVE1040	6.0	3.8	4.0																																																																																																																																																																																																
	FDA1055 FDA1254				<table border="1" style="width: 100%; border-collapse: collapse;"> <thead> <tr> <th style="background-color: #cccccc;">Part Number</th> <th style="background-color: #cccccc;">a</th> <th style="background-color: #cccccc;">b</th> <th style="background-color: #cccccc;">c</th> <th style="background-color: #cccccc;">d</th> <th style="background-color: #cccccc;">e</th> <th style="background-color: #cccccc;">f</th> </tr> </thead> <tbody> <tr><td>FDA1055</td><td>4.3</td><td>2.0</td><td>2.9</td><td>3.0</td><td>7.7</td><td>2.4</td></tr> <tr><td>FDA1254</td><td>5.0</td><td>2.5</td><td>2.9</td><td>3.0</td><td>9.7</td><td>2.4</td></tr> </tbody> </table>				Part Number	a	b	c	d	e	f	FDA1055	4.3	2.0	2.9	3.0	7.7	2.4	FDA1254	5.0	2.5	2.9	3.0	9.7	2.4																																																																																																																																																																							
Part Number		a	b	c	d	e	f																																																																																																																																																																																													
FDA1055	4.3	2.0	2.9	3.0	7.7	2.4																																																																																																																																																																																														
FDA1254	5.0	2.5	2.9	3.0	9.7	2.4																																																																																																																																																																																														
LQH32C/D	Reflow Soldering * 			Flow Soldering (except LQH32D) 																																																																																																																																																																																																
	*Applicable to flow soldering. (except LQH32D)																																																																																																																																																																																																			
LQH3NP_MR																																																																																																																																																																																																				

Attention should be paid to potential magnetic coupling effects when using the Inductor (coil) as a resonator.

Continued on the following page. ↗

Inductors for Power Lines Soldering and Mounting

Continued from the preceding page. ↘

■ Land Pattern + Solder Resist ■ Land Pattern □ Solder Resist
 (in mm)

Series	Standard Land Dimensions	
LQH43CN LQH43PN LQH43PB	<p>Reflow Soldering *</p> <p>*Applicable to flow soldering. (except LQH43PB)</p>	<p>Flow Soldering (except LQH43PB)</p>

Attention should be paid to potential magnetic coupling effects when using the Inductor (coil) as a resonator.

Series	Standard Land Dimensions	Series	Standard Land Dimensions
DEM10050C DEM10050C_DD		DG6028C DG6045C DG6050C	
DEM8030C		DG8040C	
DEM8040C DEM8045C			

Attention should be paid to potential magnetic coupling effects when using the Inductor (coil) as a resonator.

2. Standard Soldering Conditions

(1) Soldering method

Apply reflow soldering process except for flow soldering available products.

Please contact Murata regarding other soldering methods.

Solder: Use Sn-3.0Ag-0.5Cu solder.

Flux: Use rosin-based flux, but not strongly acidic flux (with chlorine content exceeding 0.2wt%).

Do not use water-soluble flux.

Please pay attention to solder paste's penetrating in order to avoid short circuit between the lines.

For additional mounting methods, please contact Murata.

Continued on the following page. ↗

Inductors for Power Lines Soldering and Mounting

Continued from the preceding page. ↘

(2) Soldering profile

● Flow Soldering profile

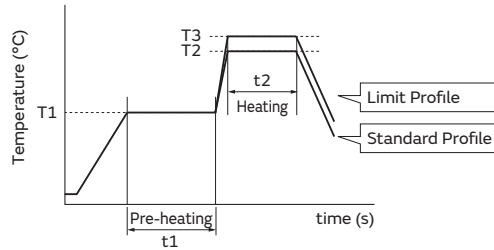

Series	Pre-heating		Standard Profile			Limit Profile		
	Temp. (T1)	Time. (t1)	Temp. (T2)	Time. (t2)	Cycle of flow	Temp. (T3)	Time. (t2)	Cycle of flow
LQM18F/18P (Except for CH/DH/FH/GH) LQM21D/21F/21P (Except for CA/CH/EH/GH) LQM2MP (Except for DH/EH/GH) LQM2HP (Except for CH/EH/GH/JH) LQM31P LQH31C	150°C	60s min.	250°C	4 to 6s	2 times max.	265±3°C	5s max.	2 times max.
LQH32C LQH43C/43PN	150°C	60s min.	250°C	4 to 6s	2 times max.	265±3°C	5s max.	1 time

● Reflow Soldering profile

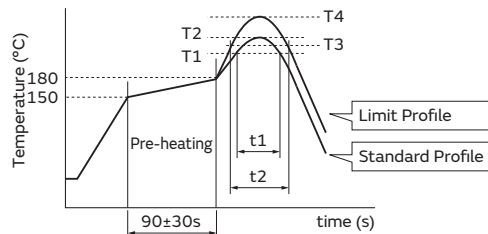

Series	Standard Profile				Limit Profile			
	Temp. (T1)	Time. (t1)	Peak temperature (T2)	Cycle of reflow	Temp. (T3)	Time. (t2)	Peak temperature (T4)	Cycle of reflow
LQM18F/18P LQM21D/21F/21P/2MP/2HP LQM31P/32P LQH2M, LQH2HP LQH31C LQH32D_23 (Except for 391/471/561) LQH32D_53 LQH3NP/32P/43P/44P/5BP LQW15C/18C/15D	220°C	30 to 60s	245±3°C	2 times max.	230°C	60s max.	260°C/10s	2 times max.
LQH32C LQH32D_23 (391/471/561 only) LQH43C LQH55D, LQH66S	220°C	30 to 60s	245±3°C	2 times max.	230°C	60s max.	260°C/10s	1 time

Continued on the following page. ↗

Inductors for Power Lines Soldering and Mounting

Continued from the preceding page. ↘

●Reflow Soldering



*Reflow Times: 2 times max.

*We recommend an infrared ray as the heat source of the reflow bath. However halogen lamp should not be used; the side heat would be beyond the range of resistance heat, so we do not recommend it.

Series	Heating		Peak Temperature	Cycle of Flow
	Temp.	Time		
D52LC	230°C	20 to 40s	250+5/-0°C	2 times max.
D53LC				
D63LCB				
DEM10050C				
DEM10050C_DD				
DEM2812C				
DEM2815C				
DEM2818C				
DEM3512C				
DEM3518C				
DEM4518C				
DEM8030C				
DEM8040C				
DEM8045C				
DFE18SAN_EO				
DFE18SAN_GO				
DFE18SBN_EO				
DFE201208S				
DFE201210S				
DFE201210U				
DFE201610C				
DFE201610E				
DFE201610P				
DFE201610R				
DFE201612C				
DFE201612E				
DFE201612P				
DFE201612R				
DFE252007F				
DFE252008C				
DFE252008U				
DFE252010C				
DFE252010F				
DFE252010P				
DFE252010R				
DFE252012C				
DFE252012F				
DFE252012P				
DFE252012R				
DFE322510C				
DFE322512C				
DFE322512F				

Series	Heating		Peak Temperature	Cycle of Flow
	Temp.	Time		
DG6028C	230°C	20 to 40s	250+5/-0°C	2 times max.
DG6045C				
DG6050C				
DG8040C				
DS104C2				
DS106C2				
DS126C2				
DS75LC				
FCUL0530				
FCUL0624				
FCUL0630				
FCUL1040				
FCUL1060				
FDA1055				
FDA1254				
FSD0412				
FSD0415				
FSD0420				
FSD0420W				
FSD0512				
FSD0515				
FSD0518				
FSD0630				
FDUE0630				
FDUE0640				
FDUE0650				
FDUE1040D				
FDUE1245				
FDUE1260				
FDV0530				
FDV0530S				
FDV0618				
FDV0620				
FDVE0630				
FDVE0640				
FDVE1040				

Continued on the following page. ↗

Inductors for Power Lines Soldering and Mounting

Continued from the preceding page. ↘

(3) Reworking with a Soldering Iron

Preheating at 150°C for 1 minute is required. Do not directly touch the ceramic element with the tip of the soldering iron. The reworking soldering conditions are as follows:

- Soldering iron power output: 80W max.
- Temperature of soldering iron tip: 350°C
- Diameter of soldering iron end: 3.0mm max.
- Soldering time: within 3 s

Please keep the fix time with the soldering iron within 1 time for each terminal.

3. Mounting Instructions

(1) Land Pattern Designing (LQH series, LQW series, DFE18SAN/SBN series)

Please follow the recommended patterns. Otherwise, their performance, which includes electrical performance or solderability, may be affected, or result in "position shift" in the soldering process.

(2) Magnetic Coupling

Since some products are constructed like an open magnetic circuit, narrow spacing between inductors (coils) may cause magnetic coupling.



(3) PCB Warping

The PCB should be designed so that products are not subjected to mechanical stress caused by warping the board.



Continued on the following page. ↗

Inductors for Power Lines Soldering and Mounting

Continued from the preceding page. ↘

(4) Amount of Solder Paste

Excessive solder causes electrode corrosion, while insufficient solder causes low electrode bonding strength. Adjust the amount of solder paste as shown on the right so that the correct amount is applied.

Guideline of solder paste thickness

- LQW15D: 50 to 100 μ m
- LQM, LQH2M/2HP, LQH3NP/32P, LQH43PB/44P/5BP, DFE18SAN/SBN: 100 to 150 μ m
- LQH31C/32C, LQH43C/43PN, LQH55D, LQH66S: 200 to 300 μ m



4. Cleaning

Beware of function well before use the product when washing. The following conditions should be observed when cleaning LQ series:

- (1) Cleaning Temperature: 60°C max. (40°C max. for alcohol cleaning agents)
- (2) Ultrasonic
Output: 20W/l max.
Duration: 5 minutes max.
Frequency: 28 to 40kHz
Care should be taken not to cause resonance of the PCB and mounted products.

(3) Cleaning agent

The following cleaning agents have been tested on individual components. Evaluation in complete assembly should be done prior to production.

- (a) Alcohol cleaning agents
Isopropyl alcohol (IPA)
- (b) Aqueous cleaning agents
Pine Alpha ST-100S
LQH66S series: Aqueous agents should not be used because they may cause quality deterioration or damage to appearance.

- (4) Ensure that flux residue is completely removed. Component should be thoroughly dried after aqueous agents have been removed with deionized water.

Inductors for Power Lines Packaging

Minimum Quantity and 8mm Width Taping Dimensions



Paper Tape

Part Number	Dimensions		Total Thickness of Tape c	Packaging Code (Minimum Qty. (pcs.))		
	a	b		ø180mm reel	ø330mm reel	Bulk
LQW15D	0.8	1.29	1.2 max.	D (8000)	—	B (500)

(in mm)

Minimum Quantity and 8mm Width Taping Dimensions



The dimension of the cavity of embossed tape is measured at the bottom side.

*1: 0.25 LQM2HP/2MP/31P_00, LQH2, LQM21P

Paper Tape 1

Part Number	Dimensions		Total Thickness of Tape c	Packaging Code (Minimum Qty. (pcs.))		
	a	b		ø180mm reel	ø330mm reel	Bulk
LQM21D (1 to 10μH)	1.45	2.25	1.1 max.	D (4000)	J (10000)	B (1000)
LQM21F (1 to 2.2μH)	1.45	2.25	1.1 max.	D (4000)	J (10000)	B (1000)
LQM21P_C0	1.45	2.25	0.8 max.	D (4000)	—	B (1000)
LQM21P_CA	1.45	1.45	0.9 max.	D (3000)	—	B (1000)
LQM21P_CH	1.45	2.25	0.7 max.	D (3000)	J (10000)	B (1000)
LQM21P_EH	1.45	2.25	1.0 max.	D (3000)	—	B (1000)
LQM21P_G	1.45	2.25	1.1 max.	D (4000)	—	B (1000)
LQM18F	1.05	1.85	1.1 max.	D (4000)	J (10000)	B (1000)
LQM18P_D0	1.05	1.85	0.85 max.	D (4000)	—	B (1000)
LQM18P_CH	1.1	1.9	0.95 max.	D (4000)	—	B (1000)
LQM18P_GH	1.1	1.9	1.25 max.	D (4000)	—	B (1000)

Paper Tape 2

Part Number	Dimensions		Total Thickness of Tape c	Packaging Code (Minimum Qty. (pcs.))		
	a	b		ø180mm reel	ø330mm reel	Bulk
LQM18PN_DH	1.05	1.85	1.05 max.	D (4000)	—	B (1000)

(in mm)

Continued on the following page. ↗

Inductors for Power Lines Packaging

Continued from the preceding page. ↘

Minimum Quantity and 8mm Width Taping Dimensions

Embossed Tape

Part Number	Dimensions		Depth of Cavity	Packaging Code (Minimum Qty. (pcs.))		
	a	b	c	ø180mm reel	ø330mm reel	Bulk
LQH2HP_DR	2.3	2.8	0.7	L (4000)	—	—
LQH2MC_02	1.9	2.3	1.05	L (3000)	—	B (100)
LQH2MC_52	1.9	2.3	0.8	L (3000)	—	B (100)
LQH2MP	1.9	2.3	1.05	L (3000)	—	—
LQH31C	1.9	3.6	2.0	L (2000)	K (7500)	—
LQH32C_33/23, LQH32D_23	2.9	3.6	2.1	L (2000)	K (7500)	—
LQH32C_53, LQH32D_53	2.9	3.6	1.7	L (2000)	K (7500)	—
LQH32PN_NC	2.9	3.6	1.7	L (2000)	K (7500)	—
LQH32PB_N0/NC, LQH32PN_N0	2.9	3.6	1.7	L (2000)	K (7500)	B (500)
LQM18P_B0	1.0	1.8	0.50	L (4000)	—	B (1000)
LQM18P_C0	1.0	1.8	0.60	L (4000)	—	B (1000)
LQM18P_F0	1.0	1.8	1.0	L (4000)	—	B (1000)
LQM21D (22 to 47μH)	1.45	2.25	1.3	L (3000)	K (10000)	B (1000)
LQM21F (4.7 to 47μH)	1.45	2.25	1.3	L (3000)	K (10000)	B (1000)
LQM21P_GH	1.45	2.25	1.05	L (3000)	—	B (1000)
LQM2HP_CH	2.3	2.8	0.6	L (3000)	K (10000)	B (1000)
LQM2HP_E0/EH	2.3	2.8	0.9	L (3000)	—	B (1000)
LQM2HP_G0/GC/GS	2.3	2.8	1.1	L (3000)	—	B (1000)
LQM2HP_GH	2.3	2.8	1.1	L (3000)	—	—
LQM2HP_J0/JC	2.25	2.75	1.3	L (3000)	—	B (1000)
LQM2HP_JH	2.25	2.75	1.3	L (3000)	—	—
LQM2MP_DH/EH	1.9	2.4	0.9	L (3000)	—	B (1000)
LQM2MP_G0	1.85	2.25	1.1	L (3000)	—	B (1000)
LQM2MP_GH	1.9	2.4	1.1	L (3000)	—	—
LQM31P_00	1.9	3.5	1.05	L (3000)	—	B (1000)
LQM32P_G0/GC	2.9	3.6	1.15	L (3000)	—	B (1000)

(in mm)

Continued on the following page. ↗

Inductors for Power Lines Packaging

Continued from the preceding page. ↘

Minimum Quantity and 8mm Width Taping Dimensions



The dimension of the cavity is measured at the bottom side.

Embossed Tape

Part Number	Dimensions		Depth of Cavity	Packaging Code (Minimum Qty. (pcs.))		
	a	b		$\phi 180$ mm reel	$\phi 330$ mm reel	Bulk
LQH2HP_GR	2.3	2.8	1.1	L (3000)	—	—
LQH2HP_JR	2.3	2.8	1.3	L (2000)	—	—



The dimension of the cavity is measured at the bottom side.

*1 0.3 LQH3NP_GR
 *2 1.1±0.1 LQH3NP_GR

Embossed Tape

Part Number	Dimensions		Depth of Cavity	Packaging Code (Minimum Qty. (pcs.))		
	a	b		$\phi 180$ mm reel	$\phi 330$ mm reel	Bulk
LQH3NP_GR	3.3	3.3	1.1	L (3000)	K (11000)	—
LQH3NP_JR	3.3	3.3	1.6	L (2000)	K (8000)	—
LQH3NP_ME	3.3	3.3	1.6	L (2000)	K (8000)	B (100)

(in mm)

Continued on the following page. ↗

Inductors for Power Lines Packaging

Continued from the preceding page. ↘

Minimum Quantity and 12mm Width Embossed Taping Dimensions



The dimension of the cavity of embossed tape is measured at the bottom side.

Embossed Tape

Part Number	Dimensions (*c: Depth of Cavity)				Packaging Code (Minimum Qty. (pcs.))		
	a	b	c	d	ø180mm reel	ø330mm reel	Bulk
LQH43C	3.6	4.9	2.7	0.3	L (500)	—	—
LQH43P	3.6	4.9	2.7	0.3	L (500)	K (2500)	—
LQH44P_J0/GR	4.3	4.3	1.4	0.3	L (1000)	K (4500)	—
LQH44P_P0	4.3	4.3	1.9	0.3	L (1000)	K (3500)	—
LQH5BP_38	5.3	5.3	4.2	0.4	L (400)	K (1500)	—
LQH5BP_T0	5.3	5.3	2.4	0.3	L (500)	K (3000)	—
LQH55D	5.4	6.1	5.0	0.4	L (350)	K (1500)	—
LQH66S	6.7	6.7	5.6	0.4	L (350)	K (1500)	—

(in mm)

Continued on the following page. ↗

Inductors for Power Lines Packaging

Continued from the preceding page. ↘

Tape and Reel Dimensions



Surface Mounting Type, Reel/Tape List

Series	Reel Size (mm)			Tape Size (mm)							Q'ty 1 Reel
	A	B1	B2	C	D	E	F	G	H	I	
DFE18SAN_E0	ø180	9.0±0.3	11.4±1	8.0±0.2	3.5±0.05	1.15±0.1/-0.05	1.95±0.05	0.92±0.05	0.25	4.0±0.1	3000
DFE18SAN_G0	ø180	9.0±0.3	11.4±1	8.0±0.2	3.5±0.05	1.15±0.1/-0.05	1.95±0.05	1.15±0.05	0.25	4.0±0.1	3000
DFE18SBN_E0	ø180	9.0±0.3	11.4±1	8.0±0.2	3.5±0.05	1.15±0.1/-0.05	1.95±0.05	0.92±0.05	0.25	4.0±0.1	3000
DFE201208S	ø180	9.0±0.3	11.4±1	8.0±0.2	3.5±0.05	1.48±0.05	2.28±0.05	1.0±0.1	0.25	4.0±0.1	3000
DFE201210S	ø180	9.0±0.3	11.4±1	8.0±0.2	3.5±0.05	1.48±0.05	2.28±0.05	1.2±0.1	0.25	4.0±0.1	3000
DFE201610C	ø180	9.0±0.3	11.4±1	8.0±0.2	3.5±0.05	1.85±0.1	2.25±0.1	1.1±0.1	0.25	4.0±0.1	3000
DFE201612C	ø180	9.0±0.3	11.4±1	8.0±0.2	3.5±0.05	1.85±0.1	2.25±0.1	1.3±0.1	0.25	4.0±0.1	3000
DFE252008C	ø180	9.0±0.3	11.4±1	8.0±0.2	3.5±0.05	2.20±0.1	2.75±0.1	1.1±0.1	0.25	4.0±0.1	3000
DFE252010C	ø180	9.0±0.3	11.4±1	8.0±0.2	3.5±0.05	2.20±0.1	2.75±0.1	1.1±0.1	0.25	4.0±0.1	3000
DFE252012C	ø180	9.0±0.3	11.4±1	8.0±0.2	3.5±0.05	2.20±0.1	2.75±0.1	1.3±0.1	0.25	4.0±0.1	3000
DFE322510C	ø180	9.0±0.3	11.4±1	8.0±0.2	3.5±0.05	2.80±0.1	3.5±0.1	1.1±0.1	0.25	4.0±0.1	3000
DFE322512C	ø180	9.0±0.3	11.4±1	8.0±0.2	3.5±0.1	2.90±0.1	3.6±0.1	1.4±0.1	0.25	4.0±0.1	3000
DFE201610R	ø180	9.0±0.3	11.4±1	8.0±0.2	3.5±0.05	1.85±0.1	2.25±0.1	1.1±0.1	0.25	4.0±0.1	3000
DFE201612R	ø180	9.0±0.3	11.4±1	8.0±0.2	3.5±0.05	1.85±0.1	2.25±0.1	1.3±0.1	0.25	4.0±0.1	3000
DFE252010R	ø180	9.0±0.3	11.4±1	8.0±0.2	3.5±0.05	2.20±0.1	2.75±0.1	1.1±0.1	0.25	4.0±0.1	3000
DFE252012R	ø180	9.0±0.3	11.4±1	8.0±0.2	3.5±0.05	2.20±0.1	2.75±0.1	1.3±0.1	0.25	4.0±0.1	3000
DFE201610P	ø180	9.0±0.3	11.4±1	8.0±0.2	3.5±0.05	1.85±0.1	2.25±0.1	1.1±0.1	0.25	4.0±0.1	3000
DFE201612P	ø180	9.0±0.3	11.4±1	8.0±0.2	3.5±0.05	1.85±0.1	2.25±0.1	1.3±0.1	0.25	4.0±0.1	3000
DFE252010P	ø180	9.0±0.3	11.4±1	8.0±0.2	3.5±0.05	2.20±0.1	2.75±0.1	1.1±0.1	0.25	4.0±0.1	3000
DFE252012P	ø180	9.0±0.3	11.4±1	8.0±0.2	3.5±0.05	2.20±0.1	2.75±0.1	1.3±0.1	0.25	4.0±0.1	3000
DFE201610E	ø180	9.0±0.3	11.4±1	8.0±0.2	3.5±0.05	1.9±0.1	2.30±0.1	1.1±0.1	0.25	4.0±0.1	3000
DFE201612E	ø180	9.0±0.3	11.4±1	8.0±0.2	3.5±0.05	1.9±0.1	2.30±0.1	1.3±0.1	0.25	4.0±0.1	3000
DFE201210U	ø180	9.0±0.3	11.4±1	8.0±0.2	3.5±0.05	1.5±0.1	2.30±0.1	1.1±0.1	0.30	4.0±0.1	3000
DFE252007F	ø180	9.0±0.3	11.4±1	8.0±0.2	3.5±0.05	2.30±0.1	2.80±0.1	0.9±0.1	0.25	4.0±0.1	3000
DFE252008U	ø180	9.0±0.3	11.4±1	8.0±0.2	3.5±0.05	2.20±0.1	2.75±0.1	1.1±0.1	0.25	4.0±0.1	3000
DFE252010F	ø180	9.0±0.3	11.4±1	8.0±0.2	3.5±0.05	2.30±0.1	2.80±0.1	1.1±0.1	0.25	4.0±0.1	3000
DFE252012F	ø180	9.0±0.3	11.4±1	8.0±0.2	3.5±0.05	2.30±0.1	2.80±0.1	1.1±0.1	0.25	4.0±0.1	3000
DFE322512F	ø180	9.0±0.3	11.4±1	8.0±0.2	3.5±0.1	2.90±0.1	3.6±0.1	1.4±0.1	0.25	4.0±0.1	3000
FDSD0412	ø330	13.5±0.5	17.5±1	12.0±0.3	5.5±0.1	4.4±0.1	4.4±0.1	1.5±0.1	0.3	8.0±0.1	4000
FDSD0415	ø330	13.5±0.5	17.5±1	12.0±0.3	5.5±0.1	4.4±0.1	4.4±0.1	1.8±0.1	0.3	8.0±0.1	4000
FDSD0420	ø330	13.5±0.5	17.5±1	12.0±0.3	5.5±0.1	4.4±0.1	4.4±0.1	2.2±0.1	0.3	8.0±0.1	2000
FDSD0420W	ø330	13.5±0.5	17.5±1	12.0±0.3	5.5±0.1	4.4±0.1	4.4±0.1	2.2±0.1	0.3	8.0±0.1	2000
FDSD0512	ø330	13.5±0.5	17.5±1	12.0±0.3	5.5±0.1	5.3±0.1	5.6±0.1	1.5±0.1	0.3	8.0±0.1	4000

Continued on the following page. ↗

Inductors for Power Lines Packaging

Continued from the preceding page. ↘

Series	Reel Size (mm)			Tape Size (mm)							Q'ty 1 Reel
	A	B1	B2	C	D	E	F	G	H	I	
FDSD0515	ø330	13.5±0.5	17.5±1	12.0±0.3	5.5±0.1	5.3±0.1	5.6±0.1	1.8±0.1	0.3	8.0±0.1	4000
FDSD0518	ø330	13.5±0.5	17.5±1	12.0±0.3	5.5±0.1	5.3±0.1	5.6±0.1	2.1±0.1	0.4	8.0±0.1	2000
FDSD0630	ø330	17.5±0.5	21.5±1	16.0±0.3	7.5±0.1	7.1±0.1	7.8±0.1	3.3±0.1	0.4	12.0±0.1	1000
FDV0530	ø330	17.5±0.5	21.5±1	16.0±0.3	7.5±0.1	6.2±0.1	6.6±0.1	3.3±0.1	0.4	12.0±0.1	1000
FDV0530S	ø330	13.5±0.5	17.5±1	12.0±0.3	5.5±0.1	5.4±0.1	5.4±0.1	3.3±0.1	0.4	12.0±0.3	1000
FDV0618	ø330	17.5±0.5	21.5±1	16.0±0.3	7.5±0.1	7.0±0.1	7.8±0.1	2.2±0.1	0.4	12.0±0.1	1500
FDV0620	ø330	17.5±0.5	21.5±1	16.0±0.3	7.5±0.1	7.0±0.1	7.8±0.1	2.2±0.1	0.4	12.0±0.1	1500
FDVE0630	ø330	17.5±0.5	21.5±1	16.0±0.3	7.5±0.1	7.0±0.1	7.8±0.1	3.3±0.1	0.4	12.0±0.1	1000
FDVE0640	ø330	17.5±0.5	21.5±1	16.0±0.3	7.5±0.1	7.1±0.1	7.8±0.1	4.3±0.1	0.4	12.0±0.1	1000
FDVE1040	ø330	25.5±0.5	29.5±1	24.0±0.3	11.5±0.1	10.5±0.1	12.1±0.1	4.3±0.1	0.4	16.0±0.1	500
FDUE0630	ø330	17.5±0.5	21.5±1	16.0±0.3	7.5±0.1	7.1±0.1	7.8±0.1	3.3±0.1	0.4	12.0±0.1	1000
FDUE0640	ø330	17.5±0.5	21.5±1	16.0±0.3	7.5±0.1	7.0±0.1	7.8±0.1	4.3±0.1	0.4	12.0±0.1	1000
FDUE0650	ø330	17.5±0.5	21.5±1	16.0±0.3	7.5±0.1	7.0±0.1	7.8±0.1	5.3±0.1	0.4	12.0±0.1	1000
FDUE1040D	ø330	25.5±0.5	29.5±1	24.0±0.3	11.5±0.1	10.5±0.1	12.1±0.1	4.3±0.1	0.4	16.0±0.1	500
FDUE1245	ø330	25.5±0.5	29.5±1	24.0±0.3	11.5±0.1	12.3±0.1	13.7±0.1	4.7±0.1	0.4	16.0±0.1	500
FDUE1260	ø330	25.5±0.5	29.5±1	24.0±0.3	11.5±0.1	12.9±0.1	14.7±0.1	6.37±0.1	0.4	16.0±0.1	500
FDA1055	ø330	25.5±0.5	29.5±1	24.0±0.3	11.5±0.1	11.1±0.1	12.0±0.1	5.7±0.1	0.4	16.0±0.1	500
FDA1254	ø330	25.5±0.5	29.5±1	24.0±0.3	11.5±0.1	12.9±0.1	13.9±0.1	5.7±0.1	0.4	16.0±0.1	500
FCUL0530	ø330	17.5±0.5	21.5±1	16.0±0.3	7.5±0.1	6.2±0.1	6.6±0.1	3.3±0.1	0.4	12.0±0.1	1000
FCUL0624	ø330	17.5±0.5	21.5±1	16.0±0.3	7.5±0.1	7.1±0.1	7.8±0.1	2.7±0.1	0.4	12.0±0.1	1500
FCUL0630	ø330	17.5±0.5	21.5±1	16.0±0.3	7.5±0.1	7.1±0.1	7.8±0.1	3.3±0.1	0.4	12.0±0.1	1000
FCUL1040	ø330	25.5±0.5	29.5±1	24.0±0.3	11.5±0.1	10.5±0.1	12.1±0.1	4.3±0.1	0.4	16.0±0.1	500
FCUL1060	ø330	25.5±0.5	29.5±1	24.0±0.3	11.5±0.1	10.5±0.1	12.1±0.1	6.3±0.1	0.4	16.0±0.1	500
DEM2812C	ø180	9.0±0.5	11.4±1	8.0±0.2	3.5±0.05	3.05±0.1	3.25±0.1	1.5±0.1	0.3	4.0±0.1	2000
DEM2815C	ø180	9.0±0.5	11.4±1	8.0±0.2	3.5±0.05	3.05±0.1	3.25±0.1	1.8±0.1	0.3	4.0±0.1	2000
DEM2818C	ø180	9.0±0.5	11.4±1	8.0±0.2	3.5±0.05	3.05±0.1	3.25±0.1	2.1±0.1	0.3	4.0±0.1	2000
DEM3512C	ø330	13.5±0.5	17.5±1	12.0±0.3	5.5±0.1	3.75±0.1	3.95±0.1	1.4±0.1	0.3	8.0±0.1	2000
DEM3518C	ø330	13.5±0.5	17.5±1	12.0±0.3	5.5±0.1	3.75±0.1	3.95±0.1	2.0±0.1	0.3	8.0±0.1	2000
DEM4518C	ø330	13.5±0.5	17.5±1	12.0±0.3	5.5±0.1	4.75±0.1	4.95±0.1	2.0±0.1	0.3	8.0±0.1	2000
D52LC	ø330	13.5±0.5	17.5±1	12.0±0.3	5.5±0.1	5.3±0.1	5.3±0.1	2.4±0.1	0.4	8.0±0.1	2000
D53LC	ø330	13.5±0.5	17.5±1	12.0±0.3	5.5±0.1	5.3±0.1	5.3±0.1	3.4±0.1	0.4	8.0±0.1	2000
D63LCB	ø330	13.5±0.5	17.5±1	12.0±0.3	5.5±0.1	6.2±0.1	6.3±0.1	3.25±0.1	0.3	12.0±0.1	1500
DG6028C	ø330	13.5±0.5	17.5±1	12.0±0.3	5.5±0.1	6.4±0.1	6.4±0.1	3.4±0.1	0.4	8.0±0.1	1500
DG6045C	ø330	13.5±0.5	17.5±1	12.0±0.3	5.5±0.1	6.4±0.1	6.4±0.1	5.1±0.1	0.4	8.0±0.1	1500
DG6050C	ø330	13.5±0.5	17.5±1	12.0±0.3	5.5±0.1	6.4±0.1	6.4±0.1	5.6±0.1	0.4	8.0±0.1	1500
DS75LC	ø330	17.5±0.5	21.5±1	16.0±0.3	7.5±0.1	7.8±0.1	7.8±0.1	5.4±0.1	0.4	12.0±0.1	1000
DG8040C	ø330	17.5±0.5	21.5±1	16.0±0.3	7.5±0.1	8.4±0.1	8.4±0.1	4.2±0.1	0.4	12.0±0.1	1000
DEM8030C	ø330	17.5±0.5	21.5±1	16.0±0.3	7.5±0.1	8.4±0.1	8.4±0.1	3.2±0.1	0.4	12.0±0.1	1000
DEM8040C	ø330	17.5±0.5	21.5±1	16.0±0.3	7.5±0.1	8.4±0.1	8.4±0.1	4.2±0.1	0.4	12.0±0.1	1000
DEM8045C	ø330	17.5±0.5	21.5±1	16.0±0.3	7.5±0.1	8.4±0.1	8.4±0.1	4.7±0.1	0.4	12.0±0.1	1000
DEM10050C	ø330	25.5±0.5	29.5±1	24.0±0.3	11.5±0.1	10.6±0.1	10.6±0.1	5.2±0.1	0.4	16.0±0.1	500
DEM10050C_DD	ø330	25.5±0.5	29.5±1	24.0±0.3	11.5±0.1	10.6±0.1	10.6±0.1	5.2±0.1	0.4	16.0±0.1	500
DS104C2	ø330	25.5±0.5	29.5±1	24.0±0.3	11.5±0.1	10.5±0.1	10.5±0.1	5.0±0.1	0.4	16.0±0.1	500
DS106C2	ø330	25.5±0.5	29.5±1	24.0±0.3	11.5±0.1	10.5±0.1	10.5±0.1	6.9±0.1	0.4	16.0±0.1	500
DS126C2	ø330	25.5±0.5	29.5±1	24.0±0.3	11.5±0.1	12.9±0.1	12.9±0.1	6.9±0.1	0.4	16.0±0.1	500

Inductors for General Circuits

Part Numbering	p154
Product Detail	p155
⚠Caution/Notice	p172
Soldering and Mounting	p174
Packaging	p178

● Part Numbering

Inductors for General Use



① Product ID

Product ID	
LQ	Chip Inductors (Chip Coils)

② Structure

Code	Structure
B	Multilayer Type (Ferrite Core)
H	Wire Wound Type (Ferrite Core)
M	Multilayer Type (Ferrite Core)
W	Wire Wound Type (Ferrite Core)

② Dimensions (LxW)

Code	Nominal Dimensions (LxW)	Size Code (in inch)
04	0.8x0.4mm	03019
15	1.0x0.5mm	0402
18	1.6x0.8mm	0603
21	2.0x1.25mm	0805
31	3.2x1.6mm	1206
32	3.2x2.5mm	1210
43	4.5x3.2mm	1812
44	4.0x4.0mm	1515

④ Applications and Characteristics

Code	Series	Applications and Characteristics
C	LQW	for Choke
N	LQB/LQM	for Resonant Circuit
J	LQM	for Resonant Circuit
N	LQH	for Resonant Circuit
M		for Resonant Circuit (Coating Type)

⑤ Category

Code	Category	
A	General	Impedance Device (Near GHz Band)
N	General	Standard Type

⑥ Inductance

Expressed by three-digit alphanumerics. The unit is micro-henry (μH). The first and second figures are significant digits, and the third figure expresses the number of zeros that follow the two figures. If there is a decimal point, it is expressed by the capital letter "R." In this case, all figures are significant digits. If inductance is less than $0.1\mu\text{H}$, the inductance code is expressed by a combination of two figures and the capital letter "N," and the unit of inductance is nano-henry (nH). The capital letter "N" indicates the unit of "nH," and also expresses a decimal point. In this case, all figures are significant digits.

⑦ Inductance Tolerance

Code	Inductance Tolerance
J	$\pm 5\%$
K	$\pm 10\%$
M	$\pm 20\%$
N	$\pm 30\%$

⑧ Features

Code	Features	Series
0	Standard Type	LQM*1 /LQH*2/LQW
1	Standard Type	LQB/LQM21N
2	Standard Type	LQH32M

*1 Except for LQM21N Series

*2 Except for LQH32 Series

⑨ Electrode

•Lead (Pb) Free

Code	Electrode	Series
0	Sn	LQB/LQM/LQW
3	LF Solder	LQH

⑩ Packaging

Code	Packaging
K	Embossed Taping ($\phi 330\text{mm}$ Reel)
L	Embossed Taping ($\phi 180\text{mm}$ Reel)
B	Bulk
J	Paper Taping ($\phi 330\text{mm}$ Reel)
D	Paper Taping ($\phi 180\text{mm}$ Reel)

Inductors for General Circuits

LQW04CA_00 Series 03019 (0805) inch (mm)



Packaging Code	Packaging	Minimum Quantity
D	ø180mm Paper Taping	10000
B	Packing in Bulk	500

Part Number (□: packaging code)	Inductance	Inductance Test Frequency	Rated Current	Max. of DC Resistance	S.R.F.* (min.)
LQW04CA60NK00□	60nH ±10%	100MHz	620mA	0.18Ω	3000MHz
LQW04CA90NK00□	90nH ±10%	100MHz	520mA	0.24Ω	2500MHz
LQW04CAR12K00□	120nH ±10%	100MHz	510mA	0.28Ω	2100MHz
LQW04CAR29K00□	290nH ±10%	100MHz	270mA	0.94Ω	1400MHz
LQW04CAR45K00□	450nH ±10%	100MHz	200mA	1.23Ω	850MHz
LQW04CAR51K00□	510nH ±10%	100MHz	200mA	1.31Ω	700MHz

Operating temp. range: -40 to 85°C
 Class of Magnetic Shield: No Shield
 Only for reflow soldering
 *S.R.F.: Self Resonant Frequency

Inductance-Frequency Characteristics (Typ.)



Impedance-Frequency Characteristics (Typ.)



LQW15CA_00 Series 0402 (1005) inch (mm)



Packaging Code	Packaging	Minimum Quantity
D	ø180mm Paper Taping	10000
B	Packing in Bulk	500

Continued on the following page. ↗

Continued from the preceding page. ↘

Part Number (□: packaging code)	Inductance	Inductance Test Frequency	Rated Current	Max. of DC Resistance	S.R.F.* (min.)	Remark
LQW15CA22NJ00□	22nH ±5%	10MHz	1300mA	0.06Ω	3000MHz	*1
LQW15CA22NK00□	22nH ±10%	10MHz	1300mA	0.06Ω	3000MHz	*1
LQW15CA39NJ00□	39nH ±5%	10MHz	1100mA	0.075Ω	2700MHz	*2
LQW15CA39NK00□	39nH ±10%	10MHz	1100mA	0.075Ω	2700MHz	*2
LQW15CA59NJ00□	59nH ±5%	10MHz	1000mA	0.095Ω	2300MHz	*3
LQW15CA59NK00□	59nH ±10%	10MHz	1000mA	0.095Ω	2300MHz	*3
LQW15CA83NJ00□	83nH ±5%	10MHz	970mA	0.12Ω	1700MHz	*4
LQW15CA83NK00□	83nH ±10%	10MHz	970mA	0.12Ω	1700MHz	*4
LQW15CAR11J00□	110nH ±5%	10MHz	900mA	0.13Ω	1600MHz	*5
LQW15CAR11K00□	110nH ±10%	10MHz	900mA	0.13Ω	1600MHz	*5
LQW15CAR14J00□	140nH ±5%	10MHz	680mA	0.18Ω	1400MHz	*6
LQW15CAR14K00□	140nH ±10%	10MHz	680mA	0.18Ω	1400MHz	*6
LQW15CAR18J00□	180nH ±5%	10MHz	640mA	0.21Ω	1300MHz	*7
LQW15CAR18K00□	180nH ±10%	10MHz	640mA	0.21Ω	1300MHz	*7
LQW15CAR22J00□	220nH ±5%	10MHz	540mA	0.29Ω	1300MHz	*8
LQW15CAR22K00□	220nH ±10%	10MHz	540mA	0.29Ω	1300MHz	*8
LQW15CAR27J00□	270nH ±5%	10MHz	480mA	0.38Ω	1200MHz	*9
LQW15CAR27K00□	270nH ±10%	10MHz	480mA	0.38Ω	1200MHz	*9
LQW15CAR32J00□	320nH ±5%	10MHz	420mA	0.41Ω	1100MHz	*10
LQW15CAR32K00□	320nH ±10%	10MHz	420mA	0.41Ω	1100MHz	*10
LQW15CAR37J00□	370nH ±5%	10MHz	360mA	0.575Ω	1000MHz	*11
LQW15CAR37K00□	370nH ±10%	10MHz	360mA	0.575Ω	1000MHz	*11
LQW15CAR39J00□	390nH ±5%	10MHz	320mA	0.72Ω	950MHz	*12
LQW15CAR39K00□	390nH ±10%	10MHz	320mA	0.72Ω	950MHz	*12
LQW15CAR43J00□	430nH ±5%	10MHz	360mA	0.68Ω	920MHz	*13
LQW15CAR43K00□	430nH ±10%	10MHz	360mA	0.68Ω	920MHz	*13
LQW15CAR50J00□	500nH ±5%	10MHz	270mA	0.97Ω	900MHz	*14
LQW15CAR50K00□	500nH ±10%	10MHz	270mA	0.97Ω	900MHz	*14
LQW15CAR56J00□	560nH ±5%	10MHz	270mA	1.00Ω	900MHz	*15
LQW15CAR56K00□	560nH ±10%	10MHz	270mA	1.00Ω	900MHz	*15
LQW15CAR64J00□	640nH ±5%	10MHz	240mA	1.40Ω	870MHz	*16
LQW15CAR64K00□	640nH ±10%	10MHz	240mA	1.40Ω	870MHz	*16
LQW15CAR73J00□	730nH ±5%	10MHz	200mA	1.95Ω	810MHz	*17
LQW15CAR73K00□	730nH ±10%	10MHz	200mA	1.95Ω	810MHz	*17
LQW15CAR80J00□	800nH ±5%	10MHz	190mA	2.10Ω	770MHz	*18
LQW15CAR80K00□	800nH ±10%	10MHz	190mA	2.10Ω	770MHz	*18
LQW15CA1R0K00□	1000nH ±10%	10MHz	180mA	2.2Ω	400MHz	*19

Operating temp. range (Self-temp. rise included): -40 to 125°C

Class of Magnetic Shield: No Shield

Only for reflow soldering

*S.R.F.: Self Resonant Frequency

*1: Typical impedance: 100Ω (typ) @ 900MHz/150Ω (typ) @ 1.7GHz

*2: Typical impedance: 180Ω (typ) @ 900MHz/280Ω (typ) @ 1.7GHz

*3: Typical impedance: 290Ω (typ) @ 900MHz/360Ω (typ) @ 1.7GHz

*4: Typical impedance: 430Ω (typ) @ 900MHz/750Ω (typ) @ 1.7GHz

*5: Typical impedance: 580Ω (typ) @ 900MHz/1000Ω (typ) @ 1.7GHz

*6: Typical impedance: 780Ω (typ) @ 900MHz/1300Ω (typ) @ 1.7GHz

*7: Typical impedance: 1000Ω (typ) @ 900MHz/1700Ω (typ) @ 1.7GHz

*8: Typical impedance: 1400Ω (typ) @ 900MHz/2000Ω (typ) @ 1.7GHz

*9: Typical impedance: 1800Ω (typ) @ 900MHz/2100Ω (typ) @ 1.7GHz

*10: Typical impedance: 2200Ω (typ) @ 900MHz/2300Ω (typ) @ 1.7GHz

*11: Typical impedance: 2800Ω (typ) @ 900MHz/2350Ω (typ) @ 1.7GHz

*12: Typical impedance: 3000Ω (typ) @ 900MHz/2400Ω (typ) @ 1.7GHz

*13: Typical impedance: 3400Ω (typ) @ 900MHz/2400Ω (typ) @ 1.7GHz

*14: Typical impedance: 4250Ω (typ) @ 900MHz/2400Ω (typ) @ 1.7GHz

*15: Typical impedance: 4950Ω (typ) @ 900MHz/2350Ω (typ) @ 1.7GHz

*16: Typical impedance: 5800Ω (typ) @ 900MHz/2400Ω (typ) @ 1.7GHz

*17: Typical impedance: 6500Ω (typ) @ 900MHz/2450Ω (typ) @ 1.7GHz

*18: Typical impedance: 7000Ω (typ) @ 900MHz/2500Ω (typ) @ 1.7GHz

*19: Typical impedance: 5200Ω (typ) @ 900MHz/1600Ω (typ) @ 1.7GHz

*20: Typical impedance: 510Ω (typ) @ 900MHz/610Ω (typ) @ 1.7GHz

Continued on the following page. ↗

Continued from the preceding page. ↘

Part Number (□: packaging code)	Inductance	Inductance Test Frequency	Rated Current	Max. of DC Resistance	S.R.F.* (min.)	Remark
LQW15CA2R0K00□	2000nH ±10%	10MHz	130mA	3.2Ω	120MHz	*20

Operating temp. range (Self-temp. rise included): -40 to 125°C
 Class of Magnetic Shield: No Shield

Only for reflow soldering

*S.R.F.: Self Resonant Frequency

- *1: Typical impedance: 100Ω (typ) @ 900MHz/150Ω (typ) @ 1.7GHz
- *2: Typical impedance: 180Ω (typ) @ 900MHz/280Ω (typ) @ 1.7GHz
- *3: Typical impedance: 290Ω (typ) @ 900MHz/360Ω (typ) @ 1.7GHz
- *4: Typical impedance: 430Ω (typ) @ 900MHz/750Ω (typ) @ 1.7GHz
- *5: Typical impedance: 580Ω (typ) @ 900MHz/1000Ω (typ) @ 1.7GHz
- *6: Typical impedance: 780Ω (typ) @ 900MHz/1300Ω (typ) @ 1.7GHz
- *7: Typical impedance: 1000Ω (typ) @ 900MHz/1700Ω (typ) @ 1.7GHz
- *8: Typical impedance: 1400Ω (typ) @ 900MHz/2000Ω (typ) @ 1.7GHz
- *9: Typical impedance: 1800Ω (typ) @ 900MHz/2100Ω (typ) @ 1.7GHz
- *10: Typical impedance: 2200Ω (typ) @ 900MHz/2300Ω (typ) @ 1.7GHz
- *11: Typical impedance: 2800Ω (typ) @ 900MHz/2350Ω (typ) @ 1.7GHz
- *12: Typical impedance: 3000Ω (typ) @ 900MHz/2400Ω (typ) @ 1.7GHz
- *13: Typical impedance: 3400Ω (typ) @ 900MHz/2400Ω (typ) @ 1.7GHz
- *14: Typical impedance: 4250Ω (typ) @ 900MHz/2400Ω (typ) @ 1.7GHz
- *15: Typical impedance: 4950Ω (typ) @ 900MHz/2350Ω (typ) @ 1.7GHz
- *16: Typical impedance: 5800Ω (typ) @ 900MHz/2400Ω (typ) @ 1.7GHz
- *17: Typical impedance: 6500Ω (typ) @ 900MHz/2450Ω (typ) @ 1.7GHz
- *18: Typical impedance: 7000Ω (typ) @ 900MHz/2500Ω (typ) @ 1.7GHz
- *19: Typical impedance: 5200Ω (typ) @ 900MHz/1600Ω (typ) @ 1.7GHz
- *20: Typical impedance: 510Ω (typ) @ 900MHz/610Ω (typ) @ 1.7GHz

Inductance-Frequency Characteristics (Typ.)



Impedance-Frequency Characteristics (Typ.)



LQW18CA_00 Series 0603 (1608) inch (mm)



Packaging Code	Packaging	Minimum Quantity
D	ø180mm Paper Taping	4000
J	ø330mm Paper Taping	10000
B	Packing in Bulk	500

Continued on the following page. ↗

Continued from the preceding page. ↘

Part Number (□: packaging code)	Inductance	Inductance Test Frequency	Rated Current	Max. of DC Resistance	S.R.F.* (min.)
LQW18CA32NJ00□	32nH ±5%	10MHz	2200mA	0.030Ω	3000MHz
LQW18CA56NJ00□	56nH ±5%	10MHz	1850mA	0.040Ω	2200MHz
LQW18CA85NJ00□	85nH ±5%	10MHz	1650mA	0.048Ω	1800MHz
LQW18CAR12J00□	120nH ±5%	10MHz	1500mA	0.058Ω	1500MHz
LQW18CAR16J00□	160nH ±5%	10MHz	1300mA	0.075Ω	1350MHz
LQW18CAR21J00□	210nH ±5%	10MHz	1050mA	0.115Ω	1150MHz
LQW18CAR27J00□	270nH ±5%	10MHz	900mA	0.150Ω	1050MHz
LQW18CAR33J00□	330nH ±5%	10MHz	780mA	0.200Ω	970MHz
LQW18CAR40J00□	400nH ±5%	10MHz	680mA	0.260Ω	900MHz
LQW18CAR48J00□	480nH ±5%	10MHz	580mA	0.350Ω	800MHz
LQW18CAR58J00□	580nH ±5%	10MHz	450mA	0.460Ω	760MHz

Operating temp. range: -40 to 85°C
 Class of Magnetic Shield: No Shield
 Only for reflow soldering
 *S.R.F.: Self Resonant Frequency

Inductance-Frequency Characteristics (Typ.)



Impedance-Frequency Characteristics (Typ.)



LQH31MN_03 Series 1206 (3216) inch (mm)



Packaging Code	Packaging	Minimum Quantity
K	ø330mm Embossed Taping	7500
L	ø180mm Embossed Taping	2000

Part Number (□: packaging code)	Inductance	Inductance Test Frequency	Q (min.)	Q Test Frequency	Rated Current	DC Resistance	S.R.F.* (min.)
LQH31MNR15K03□	0.15μH ±10%	1MHz	20	25.2MHz	250mA	0.39Ω±40%	250MHz
LQH31MNR22K03□	0.22μH ±10%	1MHz	20	25.2MHz	240mA	0.43Ω±40%	250MHz
LQH31MNR33K03□	0.33μH ±10%	1MHz	30	25.2MHz	230mA	0.45Ω±40%	250MHz
LQH31MNR47K03□	0.47μH ±10%	1MHz	30	25.2MHz	215mA	0.83Ω±40%	200MHz
LQH31MNR56K03□	0.56μH ±10%	1MHz	30	25.2MHz	200mA	0.61Ω±40%	180MHz
LQH31MNR68K03□	0.68μH ±10%	1MHz	30	25.2MHz	190mA	0.67Ω±40%	160MHz
LQH31MNR82K03□	0.82μH ±10%	1MHz	30	25.2MHz	185mA	0.73Ω±40%	120MHz
LQH31MN1R0K03□	1.0μH ±10%	1MHz	35	10MHz	175mA	0.49Ω±30%	100MHz

Operating temp. range: -40 to 85°C
 Class of Magnetic Shield: No Shield
 *S.R.F.: Self Resonant Frequency

When rated current is applied to the products, self-temperature rise shall be limited to 20°C max and inductance will be within ±10% of initial inductance value.

Continued from the preceding page. ↘

Part Number (□: packaging code)	Inductance	Inductance Test Frequency	Q (min.)	Q Test Frequency	Rated Current	DC Resistance	S.R.F.* (min.)
LQH31MN1R2J03□	1.2μH ±5%	1MHz	35	10MHz	165mA	0.37Ω±30%	90MHz
LQH31MN1R2K03□	1.2μH ±10%	1MHz	35	10MHz	165mA	0.9Ω±30%	90MHz
LQH31MN1R5J03□	1.5μH ±5%	1MHz	35	10MHz	155mA	1.0Ω±30%	75MHz
LQH31MN1R5K03□	1.5μH ±10%	1MHz	35	10MHz	155mA	1.0Ω±30%	75MHz
LQH31MN1R8J03□	1.8μH ±5%	1MHz	35	10MHz	150mA	1.6Ω±30%	60MHz
LQH31MN1R8K03□	1.8μH ±10%	1MHz	35	10MHz	150mA	1.6Ω±30%	60MHz
LQH31MN2R2J03□	2.2μH ±5%	1MHz	35	10MHz	140mA	0.7Ω±30%	50MHz
LQH31MN2R2K03□	2.2μH ±10%	1MHz	35	10MHz	140mA	0.7Ω±30%	50MHz
LQH31MN2R7J03□	2.7μH ±5%	1MHz	35	10MHz	135mA	0.55Ω±30%	43MHz
LQH31MN2R7K03□	2.7μH ±10%	1MHz	35	10MHz	135mA	0.55Ω±30%	43MHz
LQH31MN3R3J03□	3.3μH ±5%	1MHz	35	8MHz	130mA	0.61Ω±30%	38MHz
LQH31MN3R3K03□	3.3μH ±10%	1MHz	35	8MHz	130mA	0.61Ω±30%	38MHz
LQH31MN3R9J03□	3.9μH ±5%	1MHz	35	8MHz	125mA	1.5Ω±30%	35MHz
LQH31MN3R9K03□	3.9μH ±10%	1MHz	35	8MHz	125mA	1.5Ω±30%	35MHz
LQH31MN4R7J03□	4.7μH ±5%	1MHz	35	8MHz	120mA	1.7Ω±30%	31MHz
LQH31MN4R7K03□	4.7μH ±10%	1MHz	35	8MHz	120mA	1.7Ω±30%	31MHz
LQH31MN5R6J03□	5.6μH ±5%	1MHz	35	8MHz	115mA	1.8Ω±30%	28MHz
LQH31MN5R6K03□	5.6μH ±10%	1MHz	35	8MHz	115mA	1.8Ω±30%	28MHz
LQH31MN6R8J03□	6.8μH ±5%	1MHz	35	8MHz	110mA	2.0Ω±30%	25MHz
LQH31MN6R8K03□	6.8μH ±10%	1MHz	35	8MHz	110mA	2.0Ω±30%	25MHz
LQH31MN8R2J03□	8.2μH ±5%	1MHz	35	8MHz	105mA	2.2Ω±30%	23MHz
LQH31MN8R2K03□	8.2μH ±10%	1MHz	35	8MHz	105mA	2.2Ω±30%	23MHz
LQH31MN100J03□	10μH ±5%	1MHz	35	5MHz	100mA	2.5Ω±30%	20MHz
LQH31MN100K03□	10μH ±10%	1MHz	35	5MHz	100mA	2.5Ω±30%	20MHz
LQH31MN120J03□	12μH ±5%	1MHz	35	5MHz	95mA	2.7Ω±30%	18MHz
LQH31MN120K03□	12μH ±10%	1MHz	35	5MHz	95mA	2.7Ω±30%	18MHz
LQH31MN150J03□	15μH ±5%	1MHz	35	5MHz	90mA	3.0Ω±30%	16MHz
LQH31MN150K03□	15μH ±10%	1MHz	35	5MHz	90mA	3.0Ω±30%	16MHz
LQH31MN180J03□	18μH ±5%	1MHz	35	5MHz	85mA	3.4Ω±30%	15MHz
LQH31MN180K03□	18μH ±10%	1MHz	35	5MHz	85mA	3.4Ω±30%	15MHz
LQH31MN220J03□	22μH ±5%	1MHz	40	2.5MHz	85mA	3.1Ω±30%	14MHz
LQH31MN220K03□	22μH ±10%	1MHz	40	2.5MHz	85mA	3.1Ω±30%	14MHz
LQH31MN270J03□	27μH ±5%	1MHz	40	2.5MHz	85mA	3.4Ω±30%	13MHz
LQH31MN270K03□	27μH ±10%	1MHz	40	2.5MHz	85mA	3.4Ω±30%	13MHz
LQH31MN330J03□	33μH ±5%	1MHz	40	2.5MHz	80mA	3.8Ω±30%	12MHz
LQH31MN330K03□	33μH ±10%	1MHz	40	2.5MHz	80mA	3.8Ω±30%	12MHz
LQH31MN390J03□	39μH ±5%	1MHz	40	2.5MHz	55mA	7.2Ω±30%	11MHz
LQH31MN390K03□	39μH ±10%	1MHz	40	2.5MHz	55mA	7.2Ω±30%	11MHz
LQH31MN470J03□	47μH ±5%	1MHz	40	2.5MHz	55mA	8.0Ω±30%	10MHz
LQH31MN470K03□	47μH ±10%	1MHz	40	2.5MHz	55mA	8.0Ω±30%	10MHz
LQH31MN560J03□	56μH ±5%	1MHz	40	2.5MHz	50mA	8.9Ω±30%	9.0MHz
LQH31MN560K03□	56μH ±10%	1MHz	40	2.5MHz	50mA	8.9Ω±30%	9.0MHz
LQH31MN680J03□	68μH ±5%	1MHz	40	2.5MHz	50mA	9.9Ω±30%	8.5MHz
LQH31MN680K03□	68μH ±10%	1MHz	40	2.5MHz	50mA	9.9Ω±30%	8.5MHz
LQH31MN820J03□	82μH ±5%	1MHz	40	2.5MHz	45mA	11.0Ω±30%	7.5MHz
LQH31MN820K03□	82μH ±10%	1MHz	40	2.5MHz	45mA	11.0Ω±30%	7.5MHz
LQH31MN101J03□	100μH ±5%	1MHz	40	2.5MHz	45mA	12.0Ω±30%	7.0MHz
LQH31MN101K03□	100μH ±10%	1MHz	40	2.5MHz	45mA	12.0Ω±30%	7.0MHz

Operating temp. range: -40 to 85°C

Class of Magnetic Shield: No Shield

*S.R.F.: Self Resonant Frequency

When rated current is applied to the products, self-temperature rise shall be limited to 20°C max and inductance will be within ±10% of initial inductance value.

Continued on the following page. ↗

Continued from the preceding page. ↘

Inductance-Frequency Characteristics (Typ.)



Q-Frequency Characteristics (Typ.)



LQH32MN_23 Series 1210 (3225) inch (mm)



Packaging Code	Packaging	Minimum Quantity
K	ø330mm Embossed Taping	7500
L	ø180mm Embossed Taping	2000

Part Number (□: packaging code)	Inductance	Inductance Test Frequency	Q (min.)	Q Test Frequency	Rated Current	Max. of DC Resistance	S.R.F.* (min.)
LQH32MN1R0M23□	1.0µH ±20%	1MHz	20	1MHz	445mA	0.5Ω	100MHz
LQH32MN1R2M23□	1.2µH ±20%	1MHz	20	1MHz	425mA	0.6Ω	100MHz
LQH32MN1R5K23□	1.5µH ±10%	1MHz	20	1MHz	400mA	0.6Ω	75MHz
LQH32MN1R8K23□	1.8µH ±10%	1MHz	20	1MHz	390mA	0.7Ω	60MHz
LQH32MN2R2K23□	2.2µH ±10%	1MHz	20	1MHz	370mA	0.8Ω	50MHz
LQH32MN2R7K23□	2.7µH ±10%	1MHz	20	1MHz	320mA	0.9Ω	43MHz
LQH32MN3R3K23□	3.3µH ±10%	1MHz	20	1MHz	300mA	1.0Ω	38MHz
LQH32MN3R9K23□	3.9µH ±10%	1MHz	20	1MHz	290mA	1.1Ω	35MHz
LQH32MN4R7K23□	4.7µH ±10%	1MHz	20	1MHz	270mA	1.2Ω	31MHz
LQH32MN5R6K23□	5.6µH ±10%	1MHz	20	1MHz	250mA	1.3Ω	28MHz
LQH32MN6R8K23□	6.8µH ±10%	1MHz	20	1MHz	240mA	1.5Ω	25MHz
LQH32MN8R2K23□	8.2µH ±10%	1MHz	20	1MHz	225mA	1.6Ω	23MHz
LQH32MN100J23□	10µH ±5%	1MHz	35	1MHz	190mA	1.8Ω	20MHz
LQH32MN100K23□	10µH ±10%	1MHz	35	1MHz	190mA	1.8Ω	20MHz
LQH32MN120J23□	12µH ±5%	1MHz	35	1MHz	180mA	2.0Ω	18MHz
LQH32MN120K23□	12µH ±10%	1MHz	35	1MHz	180mA	2.0Ω	18MHz
LQH32MN150J23□	15µH ±5%	1MHz	35	1MHz	170mA	2.2Ω	16MHz
LQH32MN150K23□	15µH ±10%	1MHz	35	1MHz	170mA	2.2Ω	16MHz
LQH32MN180J23□	18µH ±5%	1MHz	35	1MHz	165mA	2.5Ω	15MHz
LQH32MN180K23□	18µH ±10%	1MHz	35	1MHz	165mA	2.5Ω	15MHz
LQH32MN220J23□	22µH ±5%	1MHz	35	1MHz	150mA	2.8Ω	14MHz
LQH32MN220K23□	22µH ±10%	1MHz	35	1MHz	150mA	2.8Ω	14MHz
LQH32MN270J23□	27µH ±5%	1MHz	35	1MHz	125mA	3.1Ω	13MHz
LQH32MN270K23□	27µH ±10%	1MHz	35	1MHz	125mA	3.1Ω	13MHz
LQH32MN330J23□	33µH ±5%	1MHz	40	1MHz	115mA	3.5Ω	12MHz
LQH32MN330K23□	33µH ±10%	1MHz	40	1MHz	115mA	3.5Ω	12MHz

Operating temp. range (Self-temp. rise not included): -40 to 85°C

Class of Magnetic Shield: No Shield

*S.R.F.: Self Resonant Frequency

Continued from the preceding page. ↘

Part Number (□: packaging code)	Inductance	Inductance Test Frequency	Q (min.)	Q Test Frequency	Rated Current	Max. of DC Resistance	S.R.F.* (min.)
LQH32MN390J23□	39μH ±5%	1MHz	40	1MHz	110mA	3.9Ω	11MHz
LQH32MN390K23□	39μH ±10%	1MHz	40	1MHz	110mA	3.9Ω	11MHz
LQH32MN470J23□	47μH ±5%	1MHz	40	1MHz	100mA	4.3Ω	11MHz
LQH32MN470K23□	47μH ±10%	1MHz	40	1MHz	100mA	4.3Ω	11MHz
LQH32MN560J23□	56μH ±5%	1MHz	40	1MHz	85mA	4.9Ω	10MHz
LQH32MN560K23□	56μH ±10%	1MHz	40	1MHz	85mA	4.9Ω	10MHz
LQH32MN680J23□	68μH ±5%	1MHz	40	1MHz	80mA	5.5Ω	9.0MHz
LQH32MN680K23□	68μH ±10%	1MHz	40	1MHz	80mA	5.5Ω	9.0MHz
LQH32MN820J23□	82μH ±5%	1MHz	40	1MHz	70mA	6.2Ω	8.5MHz
LQH32MN820K23□	82μH ±10%	1MHz	40	1MHz	70mA	6.2Ω	8.5MHz
LQH32MN101J23□	100μH ±5%	1MHz	40	796kHz	80mA	7.0Ω	8.0MHz
LQH32MN101K23□	100μH ±10%	1MHz	40	796kHz	80mA	7.0Ω	8.0MHz
LQH32MN121J23□	120μH ±5%	1MHz	40	796kHz	75mA	8.0Ω	7.5MHz
LQH32MN121K23□	120μH ±10%	1MHz	40	796kHz	75mA	8.0Ω	7.5MHz
LQH32MN151J23□	150μH ±5%	1MHz	40	796kHz	70mA	9.3Ω	7.0MHz
LQH32MN151K23□	150μH ±10%	1MHz	40	796kHz	70mA	9.3Ω	7.0MHz
LQH32MN181J23□	180μH ±5%	1MHz	40	796kHz	65mA	10.2Ω	6.0MHz
LQH32MN181K23□	180μH ±10%	1MHz	40	796kHz	65mA	10.2Ω	6.0MHz
LQH32MN221J23□	220μH ±5%	1MHz	40	796kHz	65mA	11.8Ω	5.5MHz
LQH32MN221K23□	220μH ±10%	1MHz	40	796kHz	65mA	11.8Ω	5.5MHz
LQH32MN271J23□	270μH ±5%	1MHz	40	796kHz	65mA	12.5Ω	5.0MHz
LQH32MN271K23□	270μH ±10%	1MHz	40	796kHz	65mA	12.5Ω	5.0MHz
LQH32MN331J23□	330μH ±5%	1MHz	40	796kHz	65mA	13.0Ω	5.0MHz
LQH32MN331K23□	330μH ±10%	1MHz	40	796kHz	65mA	13.0Ω	5.0MHz
LQH32MN391J23□	390μH ±5%	1MHz	50	796kHz	50mA	22.0Ω	5.0MHz
LQH32MN391K23□	390μH ±10%	1MHz	50	796kHz	50mA	22.0Ω	5.0MHz
LQH32MN471J23□	470μH ±5%	1kHz	50	796kHz	45mA	25.0Ω	5.0MHz
LQH32MN471K23□	470μH ±10%	1kHz	50	796kHz	45mA	25.0Ω	5.0MHz
LQH32MN561J23□	560μH ±5%	1kHz	50	796kHz	40mA	28.0Ω	5.0MHz
LQH32MN561K23□	560μH ±10%	1kHz	50	796kHz	40mA	28.0Ω	5.0MHz

Operating temp. range (Self-temp. rise not included): -40 to 85°C

Class of Magnetic Shield: No Shield

*S.R.F.: Self Resonant Frequency

Inductance-Frequency Characteristics (Typ.)



Q-Frequency Characteristics (Typ.)



LQH44NN_03 Series 1515 (4040) inch (mm)



Packaging Code	Packaging	Minimum Quantity
K	ø330mm Embossed Taping	1500
L	ø180mm Embossed Taping	250

Part Number (□: packaging code)	Inductance	Inductance Test Frequency	Rated Current	DC Resistance	S.R.F.* (min.)
LQH44NNR51M03□	0.51μH ±20%	1kHz	4.50A	0.0075Ω±30%	160MHz
LQH44NNR74M03□	0.74μH ±20%	1kHz	3.50A	0.011Ω±30%	150MHz
LQH44NN1R0M03□	1.0μH ±20%	1kHz	3.30A	0.012Ω±30%	90MHz
LQH44NN1R5M03□	1.5μH ±20%	1kHz	3.20A	0.016Ω±30%	70MHz
LQH44NN2R2M03□	2.2μH ±20%	1kHz	2.50A	0.019Ω±20%	55MHz
LQH44NN3R3M03□	3.3μH ±20%	1kHz	2.25A	0.024Ω±30%	34.8MHz
LQH44NN4R7M03□	4.7μH ±20%	1kHz	1.95A	0.040Ω±30%	23.4MHz
LQH44NN5R0K03□	5.0μH ±10%	1kHz	1.95A	0.040Ω±30%	23.4MHz
LQH44NN6R8K03□	6.8μH ±10%	1kHz	1.60A	0.051Ω±30%	19.8MHz
LQH44NN100K03□	10μH ±10%	1kHz	1.30A	0.067Ω±30%	23.5MHz
LQH44NN150K03□	15μH ±10%	1kHz	1.10A	0.100Ω±30%	11.5MHz
LQH44NN220K03□	22μH ±10%	1kHz	0.95A	0.170Ω±30%	14MHz
LQH44NN330K03□	33μH ±10%	1kHz	0.76A	0.210Ω±30%	12MHz
LQH44NN470K03□	47μH ±10%	1kHz	0.64A	0.330Ω±30%	10MHz
LQH44NN680K03□	68μH ±10%	1kHz	0.53A	0.410Ω±30%	8.0MHz
LQH44NN101K03□	100μH ±10%	1kHz	0.30A	0.540Ω±30%	6.3MHz
LQH44NN151K03□	150μH ±10%	1kHz	0.26A	0.920Ω±30%	5.2MHz
LQH44NN221K03□	220μH ±10%	1kHz	0.21A	1.20Ω±30%	3.9MHz
LQH44NN331K03□	330μH ±10%	1kHz	0.18A	1.76Ω±30%	3.0MHz
LQH44NN471K03□	470μH ±10%	1kHz	0.145A	2.23Ω±30%	2.7MHz

Operating temp. range (Self-temp. rise included): -40 to 125°C
 Operating temp. range (Self-temp. rise not included): -40 to 85°C
 Class of Magnetic Shield: No Shield
 Only for reflow soldering
 *S.R.F.: Self Resonant Frequency

When rated current is applied to the products, inductance will be within ±30% of initial inductance value. When rated current is applied to the products, the temperature rise caused by self-generated heat shall be limited to 40°C max.

Inductance-Frequency Characteristics (Typ.)

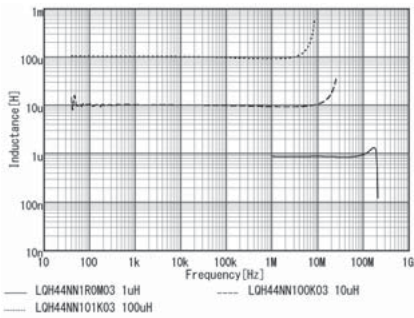

Q-Frequency Characteristics (Typ.)

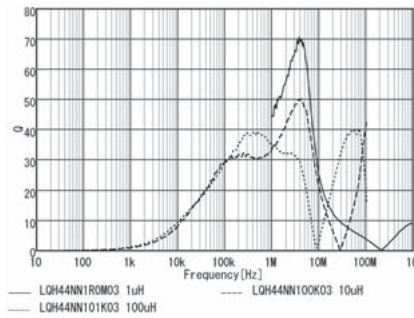

LQH43MN_03 Series 1812 (4532) inch (mm)



Packaging Code	Packaging	Minimum Quantity
K	ø330mm Embossed Taping	2500
L	ø180mm Embossed Taping	500

Part Number (□: packaging code)	Inductance	Inductance Test Frequency	Q (min.)	Q Test Frequency	Rated Current	Max. of DC Resistance	S.R.F.* (min.)
LQH43MN1R0M03□	1.0μH ±20%	1MHz	20	1MHz	500mA	0.20Ω	120MHz
LQH43MN1R2M03□	1.2μH ±20%	1MHz	20	1MHz	500mA	0.20Ω	100MHz
LQH43MN1R5M03□	1.5μH ±20%	1MHz	20	1MHz	500mA	0.30Ω	85MHz
LQH43MN1R8M03□	1.8μH ±20%	1MHz	20	1MHz	500mA	0.30Ω	75MHz
LQH43MN2R2M03□	2.2μH ±20%	1MHz	20	1MHz	500mA	0.30Ω	62MHz
LQH43MN2R7M03□	2.7μH ±20%	1MHz	20	1MHz	500mA	0.32Ω	53MHz
LQH43MN3R3M03□	3.3μH ±20%	1MHz	20	1MHz	500mA	0.35Ω	47MHz
LQH43MN3R9M03□	3.9μH ±20%	1MHz	20	1MHz	500mA	0.38Ω	41MHz
LQH43MN4R7K03□	4.7μH ±10%	1MHz	30	1MHz	500mA	0.40Ω	38MHz
LQH43MN5R6K03□	5.6μH ±10%	1MHz	30	1MHz	500mA	0.47Ω	33MHz
LQH43MN6R8K03□	6.8μH ±10%	1MHz	30	1MHz	450mA	0.50Ω	31MHz
LQH43MN8R2K03□	8.2μH ±10%	1MHz	30	1MHz	450mA	0.56Ω	27MHz
LQH43MN100J03□	10μH ±5%	1MHz	35	1MHz	400mA	0.56Ω	23MHz
LQH43MN100K03□	10μH ±10%	1MHz	35	1MHz	400mA	0.56Ω	23MHz
LQH43MN120J03□	12μH ±5%	1MHz	35	1MHz	380mA	0.62Ω	21MHz
LQH43MN120K03□	12μH ±10%	1MHz	35	1MHz	380mA	0.62Ω	21MHz
LQH43MN150J03□	15μH ±5%	1MHz	35	1MHz	360mA	0.73Ω	19MHz
LQH43MN150K03□	15μH ±10%	1MHz	35	1MHz	360mA	0.73Ω	19MHz
LQH43MN180J03□	18μH ±5%	1MHz	35	1MHz	340mA	0.82Ω	17MHz
LQH43MN180K03□	18μH ±10%	1MHz	35	1MHz	340mA	0.82Ω	17MHz
LQH43MN220J03□	22μH ±5%	1MHz	35	1MHz	320mA	0.94Ω	15MHz
LQH43MN220K03□	22μH ±10%	1MHz	35	1MHz	320mA	0.94Ω	15MHz
LQH43MN270J03□	27μH ±5%	1MHz	35	1MHz	300mA	1.1Ω	14MHz
LQH43MN270K03□	27μH ±10%	1MHz	35	1MHz	300mA	1.1Ω	14MHz
LQH43MN330J03□	33μH ±5%	1MHz	35	1MHz	270mA	1.2Ω	12MHz
LQH43MN330K03□	33μH ±10%	1MHz	35	1MHz	270mA	1.2Ω	12MHz
LQH43MN390J03□	39μH ±5%	1MHz	35	1MHz	240mA	1.4Ω	11MHz
LQH43MN390K03□	39μH ±10%	1MHz	35	1MHz	240mA	1.4Ω	11MHz
LQH43MN470J03□	47μH ±5%	1MHz	35	1MHz	220mA	1.5Ω	10MHz
LQH43MN470K03□	47μH ±10%	1MHz	35	1MHz	220mA	1.5Ω	10MHz
LQH43MN560J03□	56μH ±5%	1MHz	35	1MHz	200mA	1.7Ω	9.3MHz
LQH43MN560K03□	56μH ±10%	1MHz	35	1MHz	200mA	1.7Ω	9.3MHz
LQH43MN680J03□	68μH ±5%	1MHz	35	1MHz	180mA	1.9Ω	8.4MHz
LQH43MN680K03□	68μH ±10%	1MHz	35	1MHz	180mA	1.9Ω	8.4MHz
LQH43MN820J03□	82μH ±5%	1MHz	35	1MHz	170mA	2.2Ω	7.5MHz
LQH43MN820K03□	82μH ±10%	1MHz	35	1MHz	170mA	2.2Ω	7.5MHz
LQH43MN101J03□	100μH ±5%	1MHz	40	796kHz	160mA	2.5Ω	6.8MHz
LQH43MN101K03□	100μH ±10%	1MHz	40	796kHz	160mA	2.5Ω	6.8MHz
LQH43MN121J03□	120μH ±5%	1MHz	40	796kHz	150mA	3.0Ω	6.2MHz

Operating temp. range: -40 to 85°C

Class of Magnetic Shield: No Shield

Only for reflow soldering

*S.R.F.: Self Resonant Frequency

When rated current is applied to the products, self-temperature rise shall be limited to 20°C max and inductance will be within ±10% of initial inductance value.

Continued on the following page. ↗

Continued from the preceding page. ↘

Part Number (□: packaging code)	Inductance	Inductance Test Frequency	Q (min.)	Q Test Frequency	Rated Current	Max. of DC Resistance	S.R.F.* (min.)
LQH43MN121K03□	120μH ±10%	1MHz	40	796kHz	150mA	3.0Ω	6.2MHz
LQH43MN151J03□	150μH ±5%	1MHz	40	796kHz	130mA	3.7Ω	5.5MHz
LQH43MN151K03□	150μH ±10%	1MHz	40	796kHz	130mA	3.7Ω	5.5MHz
LQH43MN181J03□	180μH ±5%	1MHz	40	796kHz	120mA	4.5Ω	5.0MHz
LQH43MN181K03□	180μH ±10%	1MHz	40	796kHz	120mA	4.5Ω	5.0MHz
LQH43MN221J03□	220μH ±5%	1MHz	40	796kHz	110mA	5.4Ω	4.5MHz
LQH43MN221K03□	220μH ±10%	1MHz	40	796kHz	110mA	5.4Ω	4.5MHz
LQH43MN271J03□	270μH ±5%	1MHz	40	796kHz	100mA	6.8Ω	4.0MHz
LQH43MN271K03□	270μH ±10%	1MHz	40	796kHz	100mA	6.8Ω	4.0MHz
LQH43MN331J03□	330μH ±5%	1MHz	40	796kHz	95mA	8.2Ω	3.6MHz
LQH43MN331K03□	330μH ±10%	1MHz	40	796kHz	95mA	8.2Ω	3.6MHz
LQH43MN391J03□	390μH ±5%	1MHz	40	796kHz	90mA	9.7Ω	3.3MHz
LQH43MN391K03□	390μH ±10%	1MHz	40	796kHz	90mA	9.7Ω	3.3MHz
LQH43MN471J03□	470μH ±5%	1kHz	40	796kHz	80mA	11.8Ω	3.0MHz
LQH43MN471K03□	470μH ±10%	1kHz	40	796kHz	80mA	11.8Ω	3.0MHz
LQH43MN561J03□	560μH ±5%	1kHz	40	796kHz	70mA	14.5Ω	2.7MHz
LQH43MN561K03□	560μH ±10%	1kHz	40	796kHz	70mA	14.5Ω	2.7MHz
LQH43MN681J03□	680μH ±5%	1kHz	40	796kHz	65mA	17.0Ω	2.5MHz
LQH43MN681K03□	680μH ±10%	1kHz	40	796kHz	65mA	17.0Ω	2.5MHz
LQH43MN821J03□	820μH ±5%	1kHz	40	796kHz	60mA	20.5Ω	2.2MHz
LQH43MN821K03□	820μH ±10%	1kHz	40	796kHz	60mA	20.5Ω	2.2MHz
LQH43MN102J03□	1000μH ±5%	1kHz	40	252kHz	50mA	25.0Ω	2.0MHz
LQH43MN102K03□	1000μH ±10%	1kHz	40	252kHz	50mA	25.0Ω	2.0MHz
LQH43MN122J03□	1200μH ±5%	1kHz	40	252kHz	45mA	30.0Ω	1.8MHz
LQH43MN122K03□	1200μH ±10%	1kHz	40	252kHz	45mA	30.0Ω	1.8MHz
LQH43MN152J03□	1500μH ±5%	1kHz	40	252kHz	40mA	37.0Ω	1.6MHz
LQH43MN152K03□	1500μH ±10%	1kHz	40	252kHz	40mA	37.0Ω	1.6MHz

Operating temp. range: -40 to 85°C

Class of Magnetic Shield: No Shield

Only for reflow soldering

*S.R.F.: Self Resonant Frequency

When rated current is applied to the products, self-temperature rise shall be limited to 20°C max and inductance will be within ±10% of initial inductance value.

Inductance-Frequency Characteristics (Typ.)



Q-Frequency Characteristics (Typ.)



LQH43NN_03 Series 1812 (4532) inch (mm)



Packaging Code	Packaging	Minimum Quantity
K	ø330mm Embossed Taping	2500
L	ø180mm Embossed Taping	500

Part Number (□: packaging code)	Inductance	Inductance Test Frequency	Q (min.)	Q Test Frequency	Rated Current	Max. of DC Resistance	S.R.F.* (min.)
LQH43NN1R0M03□	1.0μH ±20%	1MHz	20	1MHz	500mA	0.20Ω	120MHz
LQH43NN1R2M03□	1.2μH ±20%	1MHz	20	1MHz	500mA	0.20Ω	100MHz
LQH43NN1R5M03□	1.5μH ±20%	1MHz	20	1MHz	500mA	0.30Ω	85MHz
LQH43NN1R8M03□	1.8μH ±20%	1MHz	20	1MHz	500mA	0.30Ω	75MHz
LQH43NN2R2M03□	2.2μH ±20%	1MHz	20	1MHz	500mA	0.30Ω	62MHz
LQH43NN2R7M03□	2.7μH ±20%	1MHz	20	1MHz	500mA	0.32Ω	53MHz
LQH43NN3R3M03□	3.3μH ±20%	1MHz	20	1MHz	500mA	0.35Ω	47MHz
LQH43NN3R9M03□	3.9μH ±20%	1MHz	20	1MHz	500mA	0.38Ω	41MHz
LQH43NN4R7K03□	4.7μH ±10%	1MHz	30	1MHz	500mA	0.40Ω	38MHz
LQH43NN4R7M03□	4.7μH ±20%	1MHz	30	1MHz	500mA	0.40Ω	38MHz
LQH43NN5R6K03□	5.6μH ±10%	1MHz	30	1MHz	500mA	0.47Ω	33MHz
LQH43NN5R6M03□	5.6μH ±20%	1MHz	30	1MHz	500mA	0.47Ω	33MHz
LQH43NN6R8K03□	6.8μH ±10%	1MHz	30	1MHz	450mA	0.50Ω	31MHz
LQH43NN6R8M03□	6.8μH ±20%	1MHz	30	1MHz	450mA	0.50Ω	31MHz
LQH43NN8R2K03□	8.2μH ±10%	1MHz	30	1MHz	450mA	0.56Ω	27MHz
LQH43NN8R2M03□	8.2μH ±20%	1MHz	30	1MHz	450mA	0.56Ω	27MHz
LQH43NN100J03□	10μH ±5%	1MHz	35	1MHz	400mA	0.56Ω	23MHz
LQH43NN100K03□	10μH ±10%	1MHz	35	1MHz	400mA	0.56Ω	23MHz
LQH43NN120J03□	12μH ±5%	1MHz	35	1MHz	380mA	0.62Ω	21MHz
LQH43NN120K03□	12μH ±10%	1MHz	35	1MHz	380mA	0.62Ω	21MHz
LQH43NN150J03□	15μH ±5%	1MHz	35	1MHz	360mA	0.73Ω	19MHz
LQH43NN150K03□	15μH ±10%	1MHz	35	1MHz	360mA	0.73Ω	19MHz
LQH43NN180J03□	18μH ±5%	1MHz	35	1MHz	340mA	0.82Ω	17MHz
LQH43NN180K03□	18μH ±10%	1MHz	35	1MHz	340mA	0.82Ω	17MHz
LQH43NN220J03□	22μH ±5%	1MHz	35	1MHz	320mA	0.94Ω	15MHz
LQH43NN220K03□	22μH ±10%	1MHz	35	1MHz	320mA	0.94Ω	15MHz
LQH43NN270J03□	27μH ±5%	1MHz	35	1MHz	300mA	1.1Ω	14MHz
LQH43NN270K03□	27μH ±10%	1MHz	35	1MHz	300mA	1.1Ω	14MHz
LQH43NN330J03□	33μH ±5%	1MHz	35	1MHz	270mA	1.2Ω	12MHz
LQH43NN330K03□	33μH ±10%	1MHz	35	1MHz	270mA	1.2Ω	12MHz
LQH43NN390J03□	39μH ±5%	1MHz	35	1MHz	240mA	1.4Ω	11MHz
LQH43NN390K03□	39μH ±10%	1MHz	35	1MHz	240mA	1.4Ω	11MHz
LQH43NN470J03□	47μH ±5%	1MHz	35	1MHz	220mA	1.5Ω	10MHz
LQH43NN470K03□	47μH ±10%	1MHz	35	1MHz	220mA	1.5Ω	10MHz
LQH43NN560J03□	56μH ±5%	1MHz	35	1MHz	200mA	1.7Ω	9.3MHz
LQH43NN560K03□	56μH ±10%	1MHz	35	1MHz	200mA	1.7Ω	9.3MHz
LQH43NN680J03□	68μH ±5%	1MHz	35	1MHz	180mA	1.9Ω	8.4MHz
LQH43NN680K03□	68μH ±10%	1MHz	35	1MHz	180mA	1.9Ω	8.4MHz
LQH43NN820J03□	82μH ±5%	1MHz	35	1MHz	170mA	2.2Ω	7.5MHz

Operating temp. range: -40 to 105°C

Class of Magnetic Shield: No Shield

Only for reflow soldering

*S.R.F.: Self Resonant Frequency

When rated current is applied to the products, self-temperature rise shall be limited to 20°C max and inductance will be within ±10% of initial inductance value.

Continued on the following page. ↗

Continued from the preceding page. ↘

Part Number (□: packaging code)	Inductance	Inductance Test Frequency	Q (min.)	Q Test Frequency	Rated Current	Max. of DC Resistance	S.R.F.* (min.)
LQH43NN820K03□	82μH ±10%	1MHz	35	1MHz	170mA	2.2Ω	7.5MHz
LQH43NN101J03□	100μH ±5%	1MHz	40	796kHz	160mA	2.5Ω	6.8MHz
LQH43NN101K03□	100μH ±10%	1MHz	40	796kHz	160mA	2.5Ω	6.8MHz
LQH43NN121J03□	120μH ±5%	1MHz	40	796kHz	150mA	3.0Ω	6.2MHz
LQH43NN121K03□	120μH ±10%	1MHz	40	796kHz	150mA	3.0Ω	6.2MHz
LQH43NN151J03□	150μH ±5%	1MHz	40	796kHz	130mA	3.7Ω	5.5MHz
LQH43NN151K03□	150μH ±10%	1MHz	40	796kHz	130mA	3.7Ω	5.5MHz
LQH43NN181J03□	180μH ±5%	1MHz	40	796kHz	120mA	4.5Ω	5.0MHz
LQH43NN181K03□	180μH ±10%	1MHz	40	796kHz	120mA	4.5Ω	5.0MHz
LQH43NN221J03□	220μH ±5%	1MHz	40	796kHz	110mA	5.4Ω	4.5MHz
LQH43NN221K03□	220μH ±10%	1MHz	40	796kHz	110mA	5.4Ω	4.5MHz
LQH43NN271J03□	270μH ±5%	1MHz	40	796kHz	100mA	6.8Ω	4.0MHz
LQH43NN271K03□	270μH ±10%	1MHz	40	796kHz	100mA	6.8Ω	4.0MHz
LQH43NN331J03□	330μH ±5%	1MHz	40	796kHz	95mA	8.2Ω	3.6MHz
LQH43NN331K03□	330μH ±10%	1MHz	40	796kHz	95mA	8.2Ω	3.6MHz
LQH43NN391J03□	390μH ±5%	1MHz	40	796kHz	90mA	9.7Ω	3.3MHz
LQH43NN391K03□	390μH ±10%	1MHz	40	796kHz	90mA	9.7Ω	3.3MHz
LQH43NN471J03□	470μH ±5%	1kHz	40	796kHz	80mA	11.8Ω	3.0MHz
LQH43NN471K03□	470μH ±10%	1kHz	40	796kHz	80mA	11.8Ω	3.0MHz
LQH43NN561J03□	560μH ±5%	1kHz	40	796kHz	70mA	14.5Ω	2.7MHz
LQH43NN561K03□	560μH ±10%	1kHz	40	796kHz	70mA	14.5Ω	2.7MHz
LQH43NN681J03□	680μH ±5%	1kHz	40	796kHz	65mA	17.0Ω	2.5MHz
LQH43NN681K03□	680μH ±10%	1kHz	40	796kHz	65mA	17.0Ω	2.5MHz
LQH43NN821J03□	820μH ±5%	1kHz	40	796kHz	60mA	20.5Ω	2.2MHz
LQH43NN821K03□	820μH ±10%	1kHz	40	796kHz	60mA	20.5Ω	2.2MHz
LQH43NN102J03□	1000μH ±5%	1kHz	40	252kHz	50mA	25.0Ω	2.0MHz
LQH43NN102K03□	1000μH ±10%	1kHz	40	252kHz	50mA	25.0Ω	2.0MHz
LQH43NN122J03□	1200μH ±5%	1kHz	40	252kHz	45mA	30.0Ω	1.8MHz
LQH43NN122K03□	1200μH ±10%	1kHz	40	252kHz	45mA	30.0Ω	1.8MHz
LQH43NN152J03□	1500μH ±5%	1kHz	40	252kHz	40mA	37.0Ω	1.6MHz
LQH43NN152K03□	1500μH ±10%	1kHz	40	252kHz	40mA	37.0Ω	1.6MHz
LQH43NN182J03□	1800μH ±5%	1kHz	40	252kHz	35mA	45.0Ω	1.5MHz
LQH43NN182K03□	1800μH ±10%	1kHz	40	252kHz	35mA	45.0Ω	1.5MHz
LQH43NN222J03□	2200μH ±5%	1kHz	40	252kHz	30mA	50.0Ω	1.3MHz
LQH43NN222K03□	2200μH ±10%	1kHz	40	252kHz	30mA	50.0Ω	1.3MHz
LQH43NN242J03□	2400μH ±5%	1kHz	40	252kHz	25mA	53Ω	1.2MHz
LQH43NN242K03□	2400μH ±10%	1kHz	40	252kHz	25mA	53Ω	1.2MHz

Operating temp. range: -40 to 105°C

Class of Magnetic Shield: No Shield

Only for reflow soldering

*S.R.F.: Self Resonant Frequency

When rated current is applied to the products, self-temperature rise shall be limited to 20°C max and inductance will be within ±10% of initial inductance value.

Inductance-Frequency Characteristics (Typ.)



Q-Frequency Characteristics (Typ.)



LQB15NN_10 Series 0402 (1005) inch (mm)



Packaging Code	Packaging	Minimum Quantity
D	ø180mm Paper Taping	10000
B	Packing in Bulk	1000

Part Number (□: packaging code)	Inductance	Inductance Test Frequency	Q (min.)	Q Test Frequency	Rated Current	DC Resistance	S.R.F.* (min.)
LQB15NNR22J10□	220nH ±5%	25MHz	10	25MHz	380mA	0.35Ω±25%	80MHz
LQB15NNR22K10□	220nH ±10%	25MHz	10	25MHz	380mA	0.35Ω±25%	80MHz
LQB15NNR22M10□	220nH ±20%	25MHz	10	25MHz	380mA	0.35Ω±25%	80MHz
LQB15NNR27J10□	270nH ±5%	25MHz	10	25MHz	330mA	0.41Ω±25%	80MHz
LQB15NNR27K10□	270nH ±10%	25MHz	10	25MHz	330mA	0.41Ω±25%	80MHz
LQB15NNR27M10□	270nH ±20%	25MHz	10	25MHz	330mA	0.41Ω±25%	80MHz
LQB15NNR33J10□	330nH ±5%	25MHz	10	25MHz	300mA	0.48Ω±25%	80MHz
LQB15NNR33K10□	330nH ±10%	25MHz	10	25MHz	300mA	0.48Ω±25%	80MHz
LQB15NNR33M10□	330nH ±20%	25MHz	10	25MHz	300mA	0.48Ω±25%	80MHz
LQB15NNR39J10□	390nH ±5%	25MHz	10	25MHz	300mA	0.54Ω±25%	80MHz
LQB15NNR39K10□	390nH ±10%	25MHz	10	25MHz	300mA	0.54Ω±25%	80MHz
LQB15NNR39M10□	390nH ±20%	25MHz	10	25MHz	300mA	0.54Ω±25%	80MHz
LQB15NNR47J10□	470nH ±5%	25MHz	10	25MHz	300mA	0.64Ω±25%	80MHz
LQB15NNR47K10□	470nH ±10%	25MHz	10	25MHz	300mA	0.64Ω±25%	80MHz
LQB15NNR47M10□	470nH ±20%	25MHz	10	25MHz	300mA	0.64Ω±25%	80MHz
LQB15NNR56J10□	560nH ±5%	25MHz	10	25MHz	300mA	0.73Ω±25%	80MHz
LQB15NNR56K10□	560nH ±10%	25MHz	10	25MHz	300mA	0.73Ω±25%	80MHz
LQB15NNR56M10□	560nH ±20%	25MHz	10	25MHz	300mA	0.73Ω±25%	80MHz

Operating temp. range: -55 to 125°C

Class of Magnetic Shield: Ferrite Core

Only for reflow soldering

*S.R.F.: Self Resonant Frequency

When rated current is applied to the products, self-generation of heat will rise to 25°C or less.

Inductance-Frequency Characteristics (Typ.)



— LQB15NNR22M10 220nH - - - LQB15NNR39M10 390nH
 — LQB15NNR56M10 560nH

Q-Frequency Characteristics (Typ.)



— LQB15NNR22M10 220nH - - - LQB15NNR39M10 390nH
 — LQB15NNR56M10 560nH

LQB18NN_10 Series 0603 (1608) inch (mm)



Packaging Code	Packaging	Minimum Quantity
D	ø180mm Paper Taping	4000
B	Packing in Bulk	1000

Part Number (□: packaging code)	Inductance	Inductance Test Frequency	Q (min.)	Q Test Frequency	Rated Current	Max. of DC Resistance	S.R.F.* (min.)
LQB18NNR22J10□	220nH ±5%	25MHz	25	25MHz	450mA	0.37Ω	80MHz
LQB18NNR22K10□	220nH ±10%	25MHz	25	25MHz	450mA	0.37Ω	80MHz
LQB18NNR22M10□	220nH ±20%	25MHz	25	25MHz	450mA	0.37Ω	80MHz
LQB18NNR22N10□	220nH ±30%	25MHz	25	25MHz	450mA	0.37Ω	80MHz
LQB18NNR27J10□	270nH ±5%	25MHz	25	25MHz	450mA	0.45Ω	80MHz
LQB18NNR27K10□	270nH ±10%	25MHz	25	25MHz	450mA	0.45Ω	80MHz
LQB18NNR27M10□	270nH ±20%	25MHz	25	25MHz	450mA	0.45Ω	80MHz
LQB18NNR27N10□	270nH ±30%	25MHz	25	25MHz	450mA	0.45Ω	80MHz
LQB18NNR33J10□	330nH ±5%	25MHz	25	25MHz	450mA	0.45Ω	80MHz
LQB18NNR33K10□	330nH ±10%	25MHz	25	25MHz	450mA	0.45Ω	80MHz
LQB18NNR33M10□	330nH ±20%	25MHz	25	25MHz	450mA	0.45Ω	80MHz
LQB18NNR33N10□	330nH ±30%	25MHz	25	25MHz	450mA	0.45Ω	80MHz
LQB18NNR39J10□	390nH ±5%	25MHz	25	25MHz	450mA	0.58Ω	80MHz
LQB18NNR39K10□	390nH ±10%	25MHz	25	25MHz	450mA	0.58Ω	80MHz
LQB18NNR39M10□	390nH ±20%	25MHz	25	25MHz	450mA	0.58Ω	80MHz
LQB18NNR39N10□	390nH ±30%	25MHz	25	25MHz	450mA	0.58Ω	80MHz
LQB18NNR47J10□	470nH ±5%	25MHz	25	25MHz	400mA	0.58Ω	80MHz
LQB18NNR47K10□	470nH ±10%	25MHz	25	25MHz	400mA	0.58Ω	80MHz
LQB18NNR47M10□	470nH ±20%	25MHz	25	25MHz	400mA	0.58Ω	80MHz
LQB18NNR47N10□	470nH ±30%	25MHz	25	25MHz	400mA	0.58Ω	80MHz
LQB18NNR56J10□	560nH ±5%	25MHz	25	25MHz	300mA	0.85Ω	80MHz
LQB18NNR56K10□	560nH ±10%	25MHz	25	25MHz	300mA	0.85Ω	80MHz
LQB18NNR56M10□	560nH ±20%	25MHz	25	25MHz	300mA	0.85Ω	80MHz
LQB18NNR56N10□	560nH ±30%	25MHz	25	25MHz	300mA	0.85Ω	80MHz

Operating temp. range: -55 to 125°C
 Class of Magnetic Shield: Ferrite Core
 *S.R.F.: Self Resonant Frequency

Inductance-Frequency Characteristics (Typ.)



Q-Frequency Characteristics (Typ.)



LQM18JN_00 Series 0603 (1608) inch (mm)



Packaging Code	Packaging	Minimum Quantity
D	ø180mm Paper Taping	4000
B	Packing in Bulk	1000

Part Number (□: packaging code)	Inductance	Inductance Test Frequency	Q (min.)	Q Test Frequency	Rated Current	DC Resistance	S.R.F.* (min.)
LQM18JNR10J00□	100nH ±5%	25MHz	8	25MHz	650mA	0.41Ω±25%	200MHz
LQM18JNR12J00□	120nH ±5%	25MHz	8	25MHz	610mA	0.47Ω±25%	150MHz
LQM18JNR16J00□	160nH ±5%	25MHz	8	25MHz	550mA	0.6Ω±25%	100MHz

Operating temp. range: -40 to 85°C
 Class of Magnetic Shield: Ferrite Core
 *S.R.F.: Self Resonant Frequency

Inductance-Frequency Characteristics (Typ.)



Inductance-Current Characteristics (Typ.)



LQM18NN_00 Series 0603 (1608) inch (mm)



Packaging Code	Packaging	Minimum Quantity
D	ø180mm Paper Taping	4000
J	ø330mm Paper Taping	10000
B	Packing in Bulk	1000

Continued on the following page. ↗

Continued from the preceding page. ↘

Part Number (□: packaging code)	Inductance	Inductance Test Frequency	Q (min.)	Q Test Frequency	Rated Current	Max. of DC Resistance	S.R.F.* (min.)
LQM18NN47NM00□	47nH ±20%	50MHz	10	50MHz	50mA	0.30Ω	260MHz
LQM18NN68NM00□	68nH ±20%	50MHz	10	50MHz	50mA	0.30Ω	250MHz
LQM18NN82NM00□	82nH ±20%	50MHz	10	50MHz	50mA	0.30Ω	245MHz
LQM18NNR10K00□	100nH ±10%	25MHz	15	25MHz	50mA	0.50Ω	240MHz
LQM18NNR12K00□	120nH ±10%	25MHz	15	25MHz	50mA	0.50Ω	205MHz
LQM18NNR15K00□	150nH ±10%	25MHz	15	25MHz	50mA	0.60Ω	180MHz
LQM18NNR18K00□	180nH ±10%	25MHz	15	25MHz	50mA	0.60Ω	165MHz
LQM18NNR22K00□	220nH ±10%	25MHz	15	25MHz	50mA	0.80Ω	150MHz
LQM18NNR27K00□	270nH ±10%	25MHz	15	25MHz	50mA	0.80Ω	136MHz
LQM18NNR33K00□	330nH ±10%	25MHz	15	25MHz	35mA	0.85Ω	125MHz
LQM18NNR39K00□	390nH ±10%	25MHz	15	25MHz	35mA	1.00Ω	110MHz
LQM18NNR47K00□	470nH ±10%	25MHz	15	25MHz	35mA	1.35Ω	105MHz
LQM18NNR56K00□	560nH ±10%	25MHz	15	25MHz	35mA	1.55Ω	95MHz
LQM18NNR68K00□	680nH ±10%	25MHz	15	25MHz	35mA	1.70Ω	90MHz
LQM18NNR82K00□	820nH ±10%	25MHz	15	25MHz	35mA	2.10Ω	85MHz
LQM18NN1R0K00□	1000nH ±10%	10MHz	35	10MHz	25mA	0.60Ω	75MHz
LQM18NN1R2K00□	1200nH ±10%	10MHz	35	10MHz	25mA	0.80Ω	65MHz
LQM18NN1R5K00□	1500nH ±10%	10MHz	35	10MHz	25mA	0.80Ω	60MHz
LQM18NN1R8K00□	1800nH ±10%	10MHz	35	10MHz	25mA	0.95Ω	55MHz
LQM18NN2R2K00□	2200nH ±10%	10MHz	35	10MHz	15mA	1.15Ω	50MHz

Operating temp. range: -40 to 85°C
 Class of Magnetic Shield: Ferrite Core
 *S.R.F.: Self Resonant Frequency

Inductance-Frequency Characteristics (Typ.)



Q-Frequency Characteristics (Typ.)



LQM21NN_10 Series 0805 (2012) inch (mm)



Dimension of t	Inductance: 0.1 to 2.2μH	0.85±0.2
		Inductance: 2.7 to 4.7μH

(Inductance: 0.10μH to 2.2μH)

Packaging Code	Packaging	Minimum Quantity
D	ø180mm Paper Taping	4000
J	ø330mm Paper Taping	10000
B	Packing in Bulk	1000

(Inductance: 2.7μH to 4.7μH)

Packaging Code	Packaging	Minimum Quantity
K	ø330mm Embossed Taping	10000
L	ø180mm Embossed Taping	3000
B	Packing in Bulk	1000

Continued on the following page. ↗

Inductors for Power Lines
 Inductors for General Circuits LQM21NN_10
 RF Inductors

Continued from the preceding page. ↘

Part Number (□: packaging code)	Inductance	Inductance Test Frequency	Q (min.)	Q Test Frequency	Rated Current	Max. of DC Resistance	S.R.F.* (min.)
LQM21NNR10K10□	0.10μH ±10%	25MHz	20	25MHz	250mA	0.26Ω	340MHz
LQM21NNR12K10□	0.12μH ±10%	25MHz	20	25MHz	250mA	0.29Ω	310MHz
LQM21NNR15K10□	0.15μH ±10%	25MHz	20	25MHz	250mA	0.32Ω	270MHz
LQM21NNR18K10□	0.18μH ±10%	25MHz	20	25MHz	250mA	0.35Ω	250MHz
LQM21NNR22K10□	0.22μH ±10%	25MHz	20	25MHz	250mA	0.38Ω	220MHz
LQM21NNR27K10□	0.27μH ±10%	25MHz	20	25MHz	250mA	0.42Ω	200MHz
LQM21NNR33K10□	0.33μH ±10%	25MHz	20	25MHz	250mA	0.48Ω	180MHz
LQM21NNR39K10□	0.39μH ±10%	25MHz	25	25MHz	200mA	0.53Ω	165MHz
LQM21NNR47K10□	0.47μH ±10%	25MHz	25	25MHz	200mA	0.57Ω	150MHz
LQM21NNR56K10□	0.56μH ±10%	25MHz	25	25MHz	150mA	0.63Ω	140MHz
LQM21NNR68K10□	0.68μH ±10%	25MHz	25	25MHz	150mA	0.72Ω	125MHz
LQM21NNR82K10□	0.82μH ±10%	25MHz	25	25MHz	150mA	0.81Ω	115MHz
LQM21NN1R0K10□	1.0μH ±10%	10MHz	45	10MHz	50mA	0.40Ω	107MHz
LQM21NN1R2K10□	1.2μH ±10%	10MHz	45	10MHz	50mA	0.47Ω	97MHz
LQM21NN1R5K10□	1.5μH ±10%	10MHz	45	10MHz	50mA	0.50Ω	87MHz
LQM21NN1R8K10□	1.8μH ±10%	10MHz	45	10MHz	50mA	0.57Ω	80MHz
LQM21NN2R2K10□	2.2μH ±10%	10MHz	45	10MHz	30mA	0.63Ω	71MHz
LQM21NN2R7K10□	2.7μH ±10%	10MHz	45	10MHz	30mA	0.69Ω	66MHz
LQM21NN3R3K10□	3.3μH ±10%	10MHz	45	10MHz	30mA	0.80Ω	59MHz
LQM21NN3R9K10□	3.9μH ±10%	10MHz	45	10MHz	30mA	0.89Ω	53MHz
LQM21NN4R7K10□	4.7μH ±10%	10MHz	45	10MHz	30mA	1.00Ω	47MHz

Operating temp. range: -40 to 85°C
 Class of Magnetic Shield: Ferrite Core
 *S.R.F.: Self Resonant Frequency

Inductance-Frequency Characteristics (Typ.)



Q-Frequency Characteristics (Typ.)



Inductors for General Circuits ⚠️Caution/Notice

⚠️Caution

Rating

1. About the Rated Current

Do not use products beyond the rated current as this may create excessive heat and deteriorate the insulation resistance.

Be sure to provide an appropriate fail-safe function on your product to prevent a second damage that may be caused by the abnormal function or the failure of our product.

2. About Excessive Surge Current

Surge current (pulse current or rush current) greater than the specified rated current applied to the product may cause a critical failure, such as an open circuit or burnout caused by excessive temperature rise.

Please contact us in advance if applying a surge current.

Notice

Storage and Operating Condition

<Operating Environment>

Do not use products in a chemical atmosphere such as chlorine gas, acid or sulfide gas.

<Storage Requirements>

1. Storage Period

The LQB series and LQM series should be used within 6 months; the other products should be used within 12 months.

Check solderability if this period is exceeded.

2. Storage Conditions

(1) Store products in a warehouse in compliance with the following conditions:

Temperature: -10 to +40 degrees C.

Humidity: 15 to 85% (relative humidity)

Do not subject products to rapid changes in temperature and humidity.

Do not store them in a chemical atmosphere such as one containing sulfurous acid gas, alkaline gas or acid. This will prevent electrode oxidation, which causes poor solderability and possible corrosion of inductors.

(2) Do not store products in bulk packaging to prevent collision among inductors, which causes core chipping and wire breakage.

(3) Store products on pallets to protect from humidity, dust, etc.

(4) Avoid heat shock, vibration, direct sunlight, etc.

Handling

This item is designed to have sufficient strength, but handle with care to avoid chipping or breaking its ceramic structure.

LQH_M/N series

- To prevent breaking the wire, avoid touching with sharp materials, such as tweezers or the bristles of a cleaning brush, to the wire wound portion of this product.
- To prevent breaking the core, avoid applying excessive mechanical shock to products mounted on the board.

LQW_C series

- To prevent breaking the wire, avoid touching with sharp materials, such as tweezers or other materials such as the bristles of a cleaning brush, to the wire wound portion.
- To prevent breaking the core, avoid applying excessive mechanical shock to products mounted on the board.
- In some mounting machines, when picking up components, a support pin pushes the components up from the bottom of the base tape. In this case, please remove the support pin. The support pin may damage the components and break the wire.

- The product temperature rises about 40°C maximum when the permissible current is applied to LQW15C. Please use caution regarding the temperature of the substrate and air around the part.

LQB series and LQM series

- There is the possibility that magnetism may change the inductance value. Do not use a magnet or tweezers with magnetism when handling products. (The tip of the tweezers should be molded with resin or pottery.)
- When excessive current over the rated current is applied, it may cause the inductance value to change due to magnetism.

<Transportation>

Do not apply excessive vibration or mechanical shock to product.

Continued on the following page. ↗

Inductors for General Circuits ⚠Caution/Notice

Continued from the preceding page. ↘

<Resin Coating>

When coating products with resin, the relatively high resin curing stress may change inductance values.

For exterior coating, select resin carefully so that electrical and mechanical performance of the product is not affected. Prior to use, please evaluate reliability with the product mounted in your application set.

- LQH/LQW series

An open circuit issue may occur by mechanical stress caused by the resin, amount/cured shape of resin, or operating conditions, etc. Some resins containing impurities or chloride may possibly generate chlorine by hydrolysis under some operating conditions, causing corrosion of the inductor wire and leading to an open circuit.

<Handling of a Substrate>

After mounting products on a substrate, do not apply any stress to the product caused by bending or twisting the substrate when cropping the substrate, inserting and removing a connector from the substrate, or tightening a screw to the substrate.

Excessive mechanical stress may cause cracking in the Product.



Measuring Method

Measuring Method of Inductance/Q

1. Residual elements and stray elements of test fixtures can be described by F-parameter as shown in the following:



2. The impedance of products Z_x and measured value Z_m can be described by input/output current/voltage.

$$Z_m = \frac{V_1}{I_1}, \quad Z_x = \frac{V_2}{I_2}$$

3. Thus, the relation between Z_x and Z_m is shown in the following:

$$Z_x = \alpha \frac{Z_m - \beta}{1 - Z_m \Gamma}$$

where, $\alpha = D / A = 1$

$$\beta = B / D = Z_{sm} - (1 - Y_{om} Z_{sm}) Z_{ss}$$

$$\Gamma = C / A = Y_{om}$$

(Z_{sm} : measured impedance of short chip
 Z_{ss} : residual impedance of short chip*
 Y_{om} : measured admittance when opening the fixture)

*Residual inductance of short chip

Residual Inductance	Series
0.556nH	LQW04CA/15CA
0.771nH	LQW18CA

4. L_x and Q_x should be calculated with the following equation.

$$L_x = \frac{\text{Im}(Z_x)}{2\pi f}, \quad Q_x = \frac{\text{Im}(Z_x)}{\text{Re}(Z_x)}$$

L_x : Inductance of products
 Q_x : Q of products
 f : Measuring frequency

Inductors for General Circuits Soldering and Mounting

1. Standard Land Pattern Dimensions

A high Q value is achieved when the PCB electrode land pattern is designed so that it does not project beyond the products' electrode.

Land Pattern + Solder Resist
 Land Pattern
 Solder Resist
 (in mm)

Series	Standard Land Dimensions																																																			
LQB15N LQB18N LQM18J/N LQM21N LQH31M LQH44N LQW04CA LQW15CA LQW18CA				<table border="1" style="width: 100%; border-collapse: collapse;"> <thead> <tr> <th colspan="2">Part Number</th> <th>a</th> <th>b</th> <th>c</th> </tr> </thead> <tbody> <tr> <td>LQB15NN</td> <td>Reflow</td> <td>0.4</td> <td>1.2 to 1.4</td> <td>0.5</td> </tr> <tr> <td>LQB18N</td> <td>Flow</td> <td rowspan="2">0.7</td> <td>2.2 to 2.6</td> <td rowspan="2">0.7</td> </tr> <tr> <td>LQM18J/N</td> <td>Reflow</td> <td>1.8 to 2.0</td> </tr> <tr> <td>LQM21N</td> <td></td> <td>1.2</td> <td>3.0 to 4.0</td> <td>1.0</td> </tr> <tr> <td>LQH31M</td> <td></td> <td>1.0</td> <td>4.5</td> <td>1.5</td> </tr> <tr> <td>LQH44N</td> <td></td> <td>1.3</td> <td>4.4</td> <td>3.0</td> </tr> <tr> <td>LQW04CA</td> <td></td> <td>0.45</td> <td>1.05</td> <td>0.48</td> </tr> <tr> <td>LQW15CA</td> <td></td> <td>0.45</td> <td>1.45</td> <td>0.64</td> </tr> <tr> <td>LQW18CA</td> <td></td> <td>0.7</td> <td>2.2</td> <td>1.0</td> </tr> </tbody> </table>	Part Number		a	b	c	LQB15NN	Reflow	0.4	1.2 to 1.4	0.5	LQB18N	Flow	0.7	2.2 to 2.6	0.7	LQM18J/N	Reflow	1.8 to 2.0	LQM21N		1.2	3.0 to 4.0	1.0	LQH31M		1.0	4.5	1.5	LQH44N		1.3	4.4	3.0	LQW04CA		0.45	1.05	0.48	LQW15CA		0.45	1.45	0.64	LQW18CA		0.7	2.2	1.0
Part Number		a	b	c																																																
LQB15NN	Reflow	0.4	1.2 to 1.4	0.5																																																
LQB18N	Flow	0.7	2.2 to 2.6	0.7																																																
LQM18J/N	Reflow		1.8 to 2.0																																																	
LQM21N		1.2	3.0 to 4.0	1.0																																																
LQH31M		1.0	4.5	1.5																																																
LQH44N		1.3	4.4	3.0																																																
LQW04CA		0.45	1.05	0.48																																																
LQW15CA		0.45	1.45	0.64																																																
LQW18CA		0.7	2.2	1.0																																																
LQH32M	Reflow Soldering* 	Flow Soldering 																																																		
LQH43M																																																				
LQH43N																																																				

Attention should be paid to potential magnetic coupling effects when using the Inductor (coil) as a resonator.

2. Standard Soldering Conditions

(1) Soldering method

Apply reflow soldering process except for flow soldering available products.

Please contact Murata regarding other soldering methods.

Solder: Use Sn-3.0Ag-0.5Cu solder.

Flux: Use rosin-based flux, but not strongly acidic flux (with chlorine content exceeding 0.2wt%).

Do not use water-soluble flux.

Please pay attention to solder paste's penetrating in order to avoid short circuit between the lines.

For additional mounting methods, please contact Murata.

Continued on the following page. ↗

Inductors for General Circuits Soldering and Mounting

Continued from the preceding page. ↘

(2) Soldering profile

●Flow Soldering profile



Series	Pre-heating		Standard Profile			Limit Profile		
	Temp. (T1)	Time. (t1)	Heating		Cycle of flow	Heating		Cycle of flow
			Temp. (T2)	Time. (t2)		Temp. (T3)	Time. (t1)	
LQB18N LQM18J/N LQM21N LQH31M	150°C	60s min.	250°C	4 to 6s	2 times max.	265±3°C	5s max.	2 times max.
LQH32M	150°C	60s min.	250°C	4 to 6s	2 times max.	265±3°C	5s max.	1 time

●Reflow Soldering profile



Series	Standard Profile				Limit Profile			
	Heating		Peak temperature (T2)	Cycle of reflow	Heating		Peak temperature (T4)	Cycle of reflow
	Temp. (T1)	Time. (t1)			Temp. (T3)	Time. (t2)		
LQB15N LQB18N LQM18J/N LQM21N LQH31M LQH43N LQH44N LQW04CA LQW15CA LQW18CA	220°C	30 to 60s	245±3°C	2 times max.	230°C	60s max.	260°C/10s	2 times max.
LQH32M LQH43M	220°C	30 to 60s	245±3°C	2 times max.	230°C	60s max.	260°C/10s	1 time

(3) Reworking with a Soldering Iron

*Except for LQW04CA

Preheating at 150°C for 1 minute is required. Do not directly touch the ceramic element with the tip of the soldering iron. The reworking soldering conditions are as follows:

Soldering iron power output: 80W max.

Temperature of soldering iron tip: 350°C

Diameter of soldering iron end: 3.0mm max.

Soldering time: within 3 s

Please keep the fix time with the soldering iron within 1 time for each terminal.

Continued on the following page. ↗

Inductors for General Circuits Soldering and Mounting

Continued from the preceding page. ↘

3. Mounting Instructions

(1) Land Pattern Dimensions

Large land design tend to reduce Q value of the product. Also, large protruding land areas (bordered by lines having the dimensions "c" and "d" shown) cause floating and electrode leaching.



(2) Land Pattern Designing (LQH series)

Please follow the recommended patterns. Otherwise, their performance, which includes electrical performance or solderability, may be affected, or result in "position shift" in the soldering process.

(3) Magnetic Coupling

Since some products are constructed like an open magnetic circuit, narrow spacing between inductors (coils) may cause magnetic coupling.



(4) PCB Warping

The PCB should be designed so that products are not subjected to mechanical stress caused by warping the board.



(5) Amount of Solder Paste

Excessive solder causes electrode corrosion, while insufficient solder causes low electrode bonding strength. Adjust the amount of solder paste as shown on the right so that the correct amount is applied.

Guideline of solder paste thickness

- LQM/LQW18CA: 100 to 150 μ m
- LQB: 100 to 200 μ m
- LQH: 200 to 300 μ m
- LQW04CA: 80 to 100 μ m
- LQW15CA: 50 to 100 μ m



Continued on the following page. ↗

Inductors for General Circuits Soldering and Mounting

Continued from the preceding page. ↘

4. Cleaning

The following conditions should be observed when cleaning products:

- (1) Cleaning Temperature: 60°C max. (40°C max. for alcohol cleaning agents)
- (2) Ultrasonic
Output: 20W/l max.
Duration: 5 minutes max.
Frequency: 28 to 40kHz
Care should be taken not to cause resonance of the PCB and mounted products.
- (3) Cleaning agent
The following cleaning agents have been tested on individual components. Evaluation in complete assembly should be done prior to production.
 - (a) Alcohol cleaning agents
Isopropyl alcohol (IPA)
 - (b) Aqueous cleaning agents
Pine Alpha ST-100S

- (4) Ensure that flux residue is completely removed. Component should be thoroughly dried after aqueous agents have been removed with deionized water.

For additional cleaning methods, please contact Murata.

Inductors for General Circuits Packaging

Minimum Quantity and 8mm Width Taping Dimensions



The dimension of the cavity of embossed tape is measured at the bottom side.

Paper Tape

Part Number	Dimensions		Total Thickness of Tape	Packaging Code (Minimum Qty. (pcs.))		
	a	b		c	ϕ180mm reel	ϕ330mm reel
LQB18N	1.05	1.85	1.1 max.	D (4000)	—	B (1000)
LQM21N (0.1 to 2.2μH)	1.45	2.25	1.1 max.	D (4000)	J (10000)	B (1000)
LQM18J	1.05	1.85	0.85 max.	D (4000)	—	B (1000)
LQM18N	1.05	1.85	1.1 max.	D (4000)	J (10000)	B (1000)

Embossed Tape

Part Number	Dimensions		Depth of Cavity	Packaging Code (Minimum Qty. (pcs.))		
	a	b		c	ϕ180mm reel	ϕ330mm reel
LQM21N (2.7 to 4.7μH)	1.45	2.25	1.3	L (3000)	K (10000)	B (1000)
LQH31M	1.9	3.6	2.0	L (2000)	K (7500)	—
LQH32M	2.9	3.6	2.1	L (2000)	K (7500)	—

(in mm)

Minimum Quantity and 8mm Width Taping Dimensions



Paper Tape

Part Number	Dimensions		Total Thickness of Tape	Packaging Code (Minimum Qty. (pcs.))		
	a	b		c	ϕ180mm reel	ϕ330mm reel
LQB15N	0.65	1.15	0.8 max.	D (10000)	—	B (1000)
LQW04CA	0.59	1.01	0.71 max.	D (10000)	—	B (500)
LQW15CA	0.66	1.22	0.9 max.	D (10000)	—	B (500)
LQW18CA	1.0	1.8	1.1 max.	D (4000)	J (10000)	B (500)

(in mm)

Continued on the following page. ↗

Inductors for General Circuits Packaging

Continued from the preceding page. ↘

Minimum Quantity and 12mm Width Embossed Taping Dimensions



The dimension of the cavity of embossed tape is measured at the bottom side.

Embossed Tape

Part Number	Dimensions (*c: Depth of Cavity)				Packaging Code (Minimum Qty. (pcs.))		
	a	b	c	d	ø180mm reel	ø330mm reel	Bulk
LQH43M	3.6	4.9	2.7	0.3	L (500)	K (2500)	—
LQH43N	3.6	4.9	2.7	0.3	L (500)	K (2500)	—
LQH44N	4.3	4.3	4.7	0.4	L (250)	K (1500)	—

(in mm)

RF Inductors

Part Numbering	p182
Product Detail	p183
⚠Caution/Notice	p263
Soldering and Mounting	p265
Packaging	p269

● Part Numbering

RF Inductors

(Part Number)



① Product ID

Product ID	
LQ	Chip Inductors (Chip Coils)

② Structure

Code	Structure
G	Multilayer Type (Air-core Inductors (Coils))
H	Wire Wound Type (Ferrite Core)
P	Film Type
W	Wire Wound Type (Air-core Inductors (Coils)) Wire Wound Type (Ferrite Core)

② Dimensions (LxW)

Code	Nominal Dimensions (LxW)	Size Code (in inch)
02	0.4×0.2mm	01005
03	0.6×0.3mm	0201
04	0.8×0.4mm	03015
15	1.0×0.5mm	0402
18	1.6×0.8mm	0603
21	2.0×1.25mm	0805
2B	2.0×1.5mm	0805
2U	2.5×2.0mm	1008
31	3.2×1.6mm	1206

④ Applications and Characteristics

Code	Series	Applications and Characteristics
H	LQG	Multilayer Air-core Inductors (Coils)
	LQP	Film Type (High Q Type)
M	LQP	Film Type
P		Film Type (For Large Current)
T		Film Type (Low DC Resistance Type)
A		High Q Type (UHF-SHF)
H	LQW	High Q Type (VHF-UHF)
H	LQH	for High-frequency Resonant Circuit

⑤ Category

Code	Category	
G/N	General	
S		Standard Type
Q		High Q Type
W		Specialty Dimensions

⑥ Inductance

Expressed by three-digit alphanumerics. The unit is micro-henry (μH). The first and second figures are significant digits, and the third figure expresses the number of zeros that follow the two figures. If there is a decimal point, it is expressed by the capital letter "R." In this case, all figures are significant digits. If inductance is less than 0.1μH, the inductance code is expressed by a combination of two figures and the capital letter "N," and the unit of inductance is nano-henry (nH). The capital letter "N" indicates the unit of "nH," and also expresses a decimal point. In this case, all figures are significant digits. For those products whose inductance values are specified using three designated digits, these values may be indicated using the closest two digits instead.

⑦ Inductance Tolerance

Code	Inductance Tolerance
B	±0.1nH
C	±0.2nH
D	±0.5nH
F	±1%
G	±2%
H	±3%
J	±5%
K	±10%
M	±20%
S	±0.3nH
W	±0.05nH

⑧ Features

Code	Features	Series
0	Standard Type	LQG/LQP/LQW/LQH
1	High-Q or Low DC Resistance	LQW04A/15A/15C/18A/2BH
8	Low DC Resistance/ Large Current Type	LQW15A/18A

⑨ Electrode

•Lead (Pb) Free

Code	Electrode	Series
0	Sn	LQG18H/LQP/LQW□□A/ LQW□□C/LQW21H
2		LQG15H/LQP□□H/LQP□□T/ LQP□□M/LQP□□P
3	LF Solder	LQW□□H/LQH
C	non-magnetic	LQW18AS

⑩ Packaging

Code	Packaging
K	Embossed Taping (ø330mm Reel)
L/E	Embossed Taping (ø180mm Reel)
B	Bulk
J	Paper Taping (ø330mm Reel)
D	Paper Taping (ø180mm Reel)

RF Inductors

LQG15HN_02 Series 0402 (1005) inch (mm)



Packaging Code	Packaging	Minimum Quantity
D	ø180mm Paper Taping	10000
J	ø330mm Paper Taping	50000
B	Packing in Bulk	1000

Part Number (□: packaging code)	Inductance	Inductance Test Frequency	Q (min.)	Q Test Frequency	Rated Current	Max. of DC Resistance	S.R.F.* (min.)
LQG15HN1N0B02□	1.0nH ±0.1nH	100MHz	8	100MHz	1000mA	0.07Ω	6000MHz
LQG15HN1N0C02□	1.0nH ±0.2nH	100MHz	8	100MHz	1000mA	0.07Ω	6000MHz
LQG15HN1N0S02□	1.0nH ±0.3nH	100MHz	8	100MHz	1000mA	0.07Ω	6000MHz
LQG15HN1N1B02□	1.1nH ±0.1nH	100MHz	8	100MHz	1000mA	0.08Ω	6000MHz
LQG15HN1N1C02□	1.1nH ±0.2nH	100MHz	8	100MHz	1000mA	0.08Ω	6000MHz
LQG15HN1N1S02□	1.1nH ±0.3nH	100MHz	8	100MHz	1000mA	0.08Ω	6000MHz
LQG15HN1N2B02□	1.2nH ±0.1nH	100MHz	8	100MHz	1000mA	0.08Ω	6000MHz
LQG15HN1N2C02□	1.2nH ±0.2nH	100MHz	8	100MHz	1000mA	0.08Ω	6000MHz
LQG15HN1N2S02□	1.2nH ±0.3nH	100MHz	8	100MHz	1000mA	0.08Ω	6000MHz
LQG15HN1N3B02□	1.3nH ±0.1nH	100MHz	8	100MHz	1000mA	0.08Ω	6000MHz
LQG15HN1N3C02□	1.3nH ±0.2nH	100MHz	8	100MHz	1000mA	0.08Ω	6000MHz
LQG15HN1N3S02□	1.3nH ±0.3nH	100MHz	8	100MHz	1000mA	0.08Ω	6000MHz
LQG15HN1N5B02□	1.5nH ±0.1nH	100MHz	8	100MHz	1000mA	0.08Ω	6000MHz
LQG15HN1N5C02□	1.5nH ±0.2nH	100MHz	8	100MHz	1000mA	0.08Ω	6000MHz
LQG15HN1N5S02□	1.5nH ±0.3nH	100MHz	8	100MHz	1000mA	0.08Ω	6000MHz
LQG15HN1N6B02□	1.6nH ±0.1nH	100MHz	8	100MHz	1000mA	0.08Ω	6000MHz
LQG15HN1N6C02□	1.6nH ±0.2nH	100MHz	8	100MHz	1000mA	0.08Ω	6000MHz
LQG15HN1N6S02□	1.6nH ±0.3nH	100MHz	8	100MHz	1000mA	0.08Ω	6000MHz
LQG15HN1N8B02□	1.8nH ±0.1nH	100MHz	8	100MHz	900mA	0.08Ω	6000MHz
LQG15HN1N8C02□	1.8nH ±0.2nH	100MHz	8	100MHz	900mA	0.08Ω	6000MHz
LQG15HN1N8S02□	1.8nH ±0.3nH	100MHz	8	100MHz	900mA	0.08Ω	6000MHz
LQG15HN2N0B02□	2.0nH ±0.1nH	100MHz	8	100MHz	900mA	0.09Ω	6000MHz
LQG15HN2N0C02□	2.0nH ±0.2nH	100MHz	8	100MHz	900mA	0.09Ω	6000MHz
LQG15HN2N0S02□	2.0nH ±0.3nH	100MHz	8	100MHz	900mA	0.09Ω	6000MHz
LQG15HN2N2B02□	2.2nH ±0.1nH	100MHz	8	100MHz	900mA	0.09Ω	6000MHz
LQG15HN2N2C02□	2.2nH ±0.2nH	100MHz	8	100MHz	900mA	0.09Ω	6000MHz
LQG15HN2N2S02□	2.2nH ±0.3nH	100MHz	8	100MHz	900mA	0.09Ω	6000MHz
LQG15HN2N4B02□	2.4nH ±0.1nH	100MHz	8	100MHz	800mA	0.1Ω	6000MHz
LQG15HN2N4C02□	2.4nH ±0.2nH	100MHz	8	100MHz	800mA	0.1Ω	6000MHz
LQG15HN2N4S02□	2.4nH ±0.3nH	100MHz	8	100MHz	800mA	0.1Ω	6000MHz
LQG15HN2N7B02□	2.7nH ±0.1nH	100MHz	8	100MHz	800mA	0.1Ω	6000MHz
LQG15HN2N7C02□	2.7nH ±0.2nH	100MHz	8	100MHz	800mA	0.1Ω	6000MHz
LQG15HN2N7S02□	2.7nH ±0.3nH	100MHz	8	100MHz	800mA	0.1Ω	6000MHz
LQG15HN3N0B02□	3.0nH ±0.1nH	100MHz	8	100MHz	800mA	0.11Ω	6000MHz
LQG15HN3N0C02□	3.0nH ±0.2nH	100MHz	8	100MHz	800mA	0.11Ω	6000MHz
LQG15HN3N0S02□	3.0nH ±0.3nH	100MHz	8	100MHz	800mA	0.11Ω	6000MHz
LQG15HN3N3B02□	3.3nH ±0.1nH	100MHz	8	100MHz	800mA	0.12Ω	6000MHz
LQG15HN3N3C02□	3.3nH ±0.2nH	100MHz	8	100MHz	800mA	0.12Ω	6000MHz

Operating temp. range: -55 to 125°C

Only for reflow soldering

*S.R.F.: Self Resonant Frequency

Continued on the following page. ↗

Continued from the preceding page. ↘

Part Number (□: packaging code)	Inductance	Inductance Test Frequency	Q (min.)	Q Test Frequency	Rated Current	Max. of DC Resistance	S.R.F.* (min.)
LQG15HN3N3S02□	3.3nH ±0.3nH	100MHz	8	100MHz	800mA	0.12Ω	6000MHz
LQG15HN3N6B02□	3.6nH ±0.1nH	100MHz	8	100MHz	700mA	0.13Ω	6000MHz
LQG15HN3N6C02□	3.6nH ±0.2nH	100MHz	8	100MHz	700mA	0.13Ω	6000MHz
LQG15HN3N6S02□	3.6nH ±0.3nH	100MHz	8	100MHz	700mA	0.13Ω	6000MHz
LQG15HN3N9B02□	3.9nH ±0.1nH	100MHz	8	100MHz	700mA	0.13Ω	6000MHz
LQG15HN3N9C02□	3.9nH ±0.2nH	100MHz	8	100MHz	700mA	0.13Ω	6000MHz
LQG15HN3N9S02□	3.9nH ±0.3nH	100MHz	8	100MHz	700mA	0.13Ω	6000MHz
LQG15HN4N3B02□	4.3nH ±0.1nH	100MHz	8	100MHz	700mA	0.15Ω	6000MHz
LQG15HN4N3C02□	4.3nH ±0.2nH	100MHz	8	100MHz	700mA	0.15Ω	6000MHz
LQG15HN4N3S02□	4.3nH ±0.3nH	100MHz	8	100MHz	700mA	0.15Ω	6000MHz
LQG15HN4N7B02□	4.7nH ±0.1nH	100MHz	8	100MHz	700mA	0.16Ω	6000MHz
LQG15HN4N7C02□	4.7nH ±0.2nH	100MHz	8	100MHz	700mA	0.16Ω	6000MHz
LQG15HN4N7S02□	4.7nH ±0.3nH	100MHz	8	100MHz	700mA	0.16Ω	6000MHz
LQG15HN5N1B02□	5.1nH ±0.1nH	100MHz	8	100MHz	600mA	0.16Ω	6000MHz
LQG15HN5N1C02□	5.1nH ±0.2nH	100MHz	8	100MHz	600mA	0.16Ω	6000MHz
LQG15HN5N1S02□	5.1nH ±0.3nH	100MHz	8	100MHz	600mA	0.16Ω	6000MHz
LQG15HN5N6B02□	5.6nH ±0.1nH	100MHz	8	100MHz	600mA	0.18Ω	5300MHz
LQG15HN5N6C02□	5.6nH ±0.2nH	100MHz	8	100MHz	600mA	0.18Ω	5300MHz
LQG15HN5N6S02□	5.6nH ±0.3nH	100MHz	8	100MHz	600mA	0.18Ω	5300MHz
LQG15HN6N2B02□	6.2nH ±0.1nH	100MHz	8	100MHz	600mA	0.19Ω	4300MHz
LQG15HN6N2C02□	6.2nH ±0.2nH	100MHz	8	100MHz	600mA	0.19Ω	4300MHz
LQG15HN6N2S02□	6.2nH ±0.3nH	100MHz	8	100MHz	600mA	0.19Ω	4300MHz
LQG15HN6N8G02□	6.8nH ±2%	100MHz	8	100MHz	600mA	0.21Ω	4200MHz
LQG15HN6N8H02□	6.8nH ±3%	100MHz	8	100MHz	600mA	0.21Ω	4200MHz
LQG15HN6N8J02□	6.8nH ±5%	100MHz	8	100MHz	600mA	0.21Ω	4200MHz
LQG15HN7N5G02□	7.5nH ±2%	100MHz	8	100MHz	500mA	0.24Ω	3900MHz
LQG15HN7N5H02□	7.5nH ±3%	100MHz	8	100MHz	500mA	0.24Ω	3900MHz
LQG15HN7N5J02□	7.5nH ±5%	100MHz	8	100MHz	500mA	0.24Ω	3900MHz
LQG15HN8N2G02□	8.2nH ±2%	100MHz	8	100MHz	500mA	0.25Ω	3600MHz
LQG15HN8N2H02□	8.2nH ±3%	100MHz	8	100MHz	500mA	0.25Ω	3600MHz
LQG15HN8N2J02□	8.2nH ±5%	100MHz	8	100MHz	500mA	0.25Ω	3600MHz
LQG15HN9N1G02□	9.1nH ±2%	100MHz	8	100MHz	500mA	0.27Ω	3400MHz
LQG15HN9N1H02□	9.1nH ±3%	100MHz	8	100MHz	500mA	0.27Ω	3400MHz
LQG15HN9N1J02□	9.1nH ±5%	100MHz	8	100MHz	500mA	0.27Ω	3400MHz
LQG15HN10NG02□	10nH ±2%	100MHz	8	100MHz	500mA	0.29Ω	3200MHz
LQG15HN10NH02□	10nH ±3%	100MHz	8	100MHz	500mA	0.29Ω	3200MHz
LQG15HN10NJ02□	10nH ±5%	100MHz	8	100MHz	500mA	0.29Ω	3200MHz
LQG15HN12NG02□	12nH ±2%	100MHz	8	100MHz	400mA	0.4Ω	2800MHz
LQG15HN12NH02□	12nH ±3%	100MHz	8	100MHz	400mA	0.4Ω	2800MHz
LQG15HN12NJ02□	12nH ±5%	100MHz	8	100MHz	400mA	0.4Ω	2800MHz
LQG15HN15NG02□	15nH ±2%	100MHz	8	100MHz	400mA	0.45Ω	2300MHz
LQG15HN15NH02□	15nH ±3%	100MHz	8	100MHz	400mA	0.45Ω	2300MHz
LQG15HN15NJ02□	15nH ±5%	100MHz	8	100MHz	400mA	0.45Ω	2300MHz
LQG15HN18NG02□	18nH ±2%	100MHz	8	100MHz	350mA	0.51Ω	2100MHz
LQG15HN18NH02□	18nH ±3%	100MHz	8	100MHz	350mA	0.51Ω	2100MHz
LQG15HN18NJ02□	18nH ±5%	100MHz	8	100MHz	350mA	0.51Ω	2100MHz
LQG15HN22NG02□	22nH ±2%	100MHz	8	100MHz	350mA	0.58Ω	1800MHz
LQG15HN22NH02□	22nH ±3%	100MHz	8	100MHz	350mA	0.58Ω	1800MHz
LQG15HN22NJ02□	22nH ±5%	100MHz	8	100MHz	350mA	0.58Ω	1800MHz
LQG15HN27NG02□	27nH ±2%	100MHz	8	100MHz	300mA	0.67Ω	1600MHz
LQG15HN27NH02□	27nH ±3%	100MHz	8	100MHz	300mA	0.67Ω	1600MHz
LQG15HN27NJ02□	27nH ±5%	100MHz	8	100MHz	300mA	0.67Ω	1600MHz
LQG15HN33NG02□	33nH ±2%	100MHz	8	100MHz	300mA	0.67Ω	1500MHz

Operating temp. range: -55 to 125°C
 Only for reflow soldering
 *S.R.F.: Self Resonant Frequency

Continued on the following page. ↗

Continued from the preceding page. ↘

Part Number (□: packaging code)	Inductance	Inductance Test Frequency	Q (min.)	Q Test Frequency	Rated Current	Max. of DC Resistance	S.R.F.* (min.)
LQG15HN33NH02□	33nH ±3%	100MHz	8	100MHz	300mA	0.67Ω	1500MHz
LQG15HN33NJ02□	33nH ±5%	100MHz	8	100MHz	300mA	0.67Ω	1500MHz
LQG15HN39NG02□	39nH ±2%	100MHz	8	100MHz	250mA	1.06Ω	1200MHz
LQG15HN39NH02□	39nH ±3%	100MHz	8	100MHz	250mA	1.06Ω	1200MHz
LQG15HN39NJ02□	39nH ±5%	100MHz	8	100MHz	250mA	1.06Ω	1200MHz
LQG15HN47NG02□	47nH ±2%	100MHz	8	100MHz	250mA	1.15Ω	1000MHz
LQG15HN47NH02□	47nH ±3%	100MHz	8	100MHz	250mA	1.15Ω	1000MHz
LQG15HN47NJ02□	47nH ±5%	100MHz	8	100MHz	250mA	1.15Ω	1000MHz
LQG15HN56NG02□	56nH ±2%	100MHz	8	100MHz	200mA	1.2Ω	800MHz
LQG15HN56NH02□	56nH ±3%	100MHz	8	100MHz	200mA	1.2Ω	800MHz
LQG15HN56NJ02□	56nH ±5%	100MHz	8	100MHz	200mA	1.2Ω	800MHz
LQG15HN68NG02□	68nH ±2%	100MHz	8	100MHz	200mA	1.25Ω	800MHz
LQG15HN68NH02□	68nH ±3%	100MHz	8	100MHz	200mA	1.25Ω	800MHz
LQG15HN68NJ02□	68nH ±5%	100MHz	8	100MHz	200mA	1.25Ω	800MHz
LQG15HN82NG02□	82nH ±2%	100MHz	8	100MHz	200mA	1.6Ω	600MHz
LQG15HN82NH02□	82nH ±3%	100MHz	8	100MHz	200mA	1.6Ω	600MHz
LQG15HN82NJ02□	82nH ±5%	100MHz	8	100MHz	200mA	1.6Ω	600MHz
LQG15HNR10G02□	100nH ±2%	100MHz	8	100MHz	200mA	1.6Ω	600MHz
LQG15HNR10H02□	100nH ±3%	100MHz	8	100MHz	200mA	1.6Ω	600MHz
LQG15HNR10J02□	100nH ±5%	100MHz	8	100MHz	200mA	1.6Ω	600MHz
LQG15HNR12G02□	120nH ±2%	100MHz	8	100MHz	150mA	1.6Ω	600MHz
LQG15HNR12H02□	120nH ±3%	100MHz	8	100MHz	150mA	1.6Ω	600MHz
LQG15HNR12J02□	120nH ±5%	100MHz	8	100MHz	150mA	1.6Ω	600MHz

Operating temp. range: -55 to 125°C

Only for reflow soldering

*S.R.F.: Self Resonant Frequency

Inductance-Frequency Characteristics (Typ.)



Q-Frequency Characteristics (Typ.)



LQG15HS_02 Series 0402 (1005) inch (mm)



Packaging Code	Packaging	Minimum Quantity
D	ø180mm Paper Taping	10000
J	ø330mm Paper Taping	50000
B	Packing in Bulk	1000

Continued on the following page. ↗

Continued from the preceding page. ↘

Part Number (□: packaging code)	Inductance	Inductance Test Frequency	Q (min.)	Q Test Frequency	Rated Current	Max. of DC Resistance	S.R.F.* (min.)
LQG15HS1N0B02□	1.0nH ±0.1nH	100MHz	8	100MHz	1000mA	0.07Ω	10000MHz
LQG15HS1N0C02□	1.0nH ±0.2nH	100MHz	8	100MHz	1000mA	0.07Ω	10000MHz
LQG15HS1N0S02□	1.0nH ±0.3nH	100MHz	8	100MHz	1000mA	0.07Ω	10000MHz
LQG15HS1N1B02□	1.1nH ±0.1nH	100MHz	8	100MHz	1000mA	0.07Ω	6000MHz
LQG15HS1N1C02□	1.1nH ±0.2nH	100MHz	8	100MHz	1000mA	0.07Ω	6000MHz
LQG15HS1N1S02□	1.1nH ±0.3nH	100MHz	8	100MHz	1000mA	0.07Ω	6000MHz
LQG15HS1N2B02□	1.2nH ±0.1nH	100MHz	8	100MHz	1000mA	0.07Ω	6000MHz
LQG15HS1N2C02□	1.2nH ±0.2nH	100MHz	8	100MHz	1000mA	0.07Ω	6000MHz
LQG15HS1N2S02□	1.2nH ±0.3nH	100MHz	8	100MHz	1000mA	0.07Ω	6000MHz
LQG15HS1N3B02□	1.3nH ±0.1nH	100MHz	8	100MHz	1000mA	0.07Ω	6000MHz
LQG15HS1N3C02□	1.3nH ±0.2nH	100MHz	8	100MHz	1000mA	0.07Ω	6000MHz
LQG15HS1N3S02□	1.3nH ±0.3nH	100MHz	8	100MHz	1000mA	0.07Ω	6000MHz
LQG15HS1N5B02□	1.5nH ±0.1nH	100MHz	8	100MHz	1000mA	0.07Ω	6000MHz
LQG15HS1N5C02□	1.5nH ±0.2nH	100MHz	8	100MHz	1000mA	0.07Ω	6000MHz
LQG15HS1N5S02□	1.5nH ±0.3nH	100MHz	8	100MHz	1000mA	0.07Ω	6000MHz
LQG15HS1N6B02□	1.6nH ±0.1nH	100MHz	8	100MHz	1000mA	0.07Ω	6000MHz
LQG15HS1N6C02□	1.6nH ±0.2nH	100MHz	8	100MHz	1000mA	0.07Ω	6000MHz
LQG15HS1N6S02□	1.6nH ±0.3nH	100MHz	8	100MHz	1000mA	0.07Ω	6000MHz
LQG15HS1N8B02□	1.8nH ±0.1nH	100MHz	8	100MHz	950mA	0.08Ω	6000MHz
LQG15HS1N8C02□	1.8nH ±0.2nH	100MHz	8	100MHz	950mA	0.08Ω	6000MHz
LQG15HS1N8S02□	1.8nH ±0.3nH	100MHz	8	100MHz	950mA	0.08Ω	6000MHz
LQG15HS2N0B02□	2.0nH ±0.1nH	100MHz	8	100MHz	900mA	0.09Ω	6000MHz
LQG15HS2N0C02□	2.0nH ±0.2nH	100MHz	8	100MHz	900mA	0.09Ω	6000MHz
LQG15HS2N0S02□	2.0nH ±0.3nH	100MHz	8	100MHz	900mA	0.09Ω	6000MHz
LQG15HS2N2B02□	2.2nH ±0.1nH	100MHz	8	100MHz	900mA	0.09Ω	6000MHz
LQG15HS2N2C02□	2.2nH ±0.2nH	100MHz	8	100MHz	900mA	0.09Ω	6000MHz
LQG15HS2N2S02□	2.2nH ±0.3nH	100MHz	8	100MHz	900mA	0.09Ω	6000MHz
LQG15HS2N4B02□	2.4nH ±0.1nH	100MHz	8	100MHz	850mA	0.11Ω	6000MHz
LQG15HS2N4C02□	2.4nH ±0.2nH	100MHz	8	100MHz	850mA	0.11Ω	6000MHz
LQG15HS2N4S02□	2.4nH ±0.3nH	100MHz	8	100MHz	850mA	0.11Ω	6000MHz
LQG15HS2N7B02□	2.7nH ±0.1nH	100MHz	8	100MHz	800mA	0.12Ω	6000MHz
LQG15HS2N7C02□	2.7nH ±0.2nH	100MHz	8	100MHz	800mA	0.12Ω	6000MHz
LQG15HS2N7S02□	2.7nH ±0.3nH	100MHz	8	100MHz	800mA	0.12Ω	6000MHz
LQG15HS3N0B02□	3.0nH ±0.1nH	100MHz	8	100MHz	800mA	0.125Ω	6000MHz
LQG15HS3N0C02□	3.0nH ±0.2nH	100MHz	8	100MHz	800mA	0.125Ω	6000MHz
LQG15HS3N0S02□	3.0nH ±0.3nH	100MHz	8	100MHz	800mA	0.125Ω	6000MHz
LQG15HS3N3B02□	3.3nH ±0.1nH	100MHz	8	100MHz	800mA	0.125Ω	6000MHz
LQG15HS3N3C02□	3.3nH ±0.2nH	100MHz	8	100MHz	800mA	0.125Ω	6000MHz
LQG15HS3N3S02□	3.3nH ±0.3nH	100MHz	8	100MHz	800mA	0.125Ω	6000MHz
LQG15HS3N6B02□	3.6nH ±0.1nH	100MHz	8	100MHz	750mA	0.14Ω	6000MHz
LQG15HS3N6C02□	3.6nH ±0.2nH	100MHz	8	100MHz	750mA	0.14Ω	6000MHz
LQG15HS3N6S02□	3.6nH ±0.3nH	100MHz	8	100MHz	750mA	0.14Ω	6000MHz
LQG15HS3N9B02□	3.9nH ±0.1nH	100MHz	8	100MHz	750mA	0.14Ω	6000MHz
LQG15HS3N9C02□	3.9nH ±0.2nH	100MHz	8	100MHz	750mA	0.14Ω	6000MHz
LQG15HS3N9S02□	3.9nH ±0.3nH	100MHz	8	100MHz	750mA	0.14Ω	6000MHz
LQG15HS4N3B02□	4.3nH ±0.1nH	100MHz	8	100MHz	750mA	0.14Ω	6000MHz
LQG15HS4N3C02□	4.3nH ±0.2nH	100MHz	8	100MHz	750mA	0.14Ω	6000MHz
LQG15HS4N3S02□	4.3nH ±0.3nH	100MHz	8	100MHz	750mA	0.14Ω	6000MHz
LQG15HS4N7B02□	4.7nH ±0.1nH	100MHz	8	100MHz	700mA	0.16Ω	6000MHz
LQG15HS4N7C02□	4.7nH ±0.2nH	100MHz	8	100MHz	700mA	0.16Ω	6000MHz
LQG15HS4N7S02□	4.7nH ±0.3nH	100MHz	8	100MHz	700mA	0.16Ω	6000MHz
LQG15HS5N1B02□	5.1nH ±0.1nH	100MHz	8	100MHz	650mA	0.18Ω	5300MHz
LQG15HS5N1C02□	5.1nH ±0.2nH	100MHz	8	100MHz	650mA	0.18Ω	5300MHz

Operating temp. range: -55 to 125°C
 Only for reflow soldering
 *S.R.F.: Self Resonant Frequency

Continued on the following page. ↗

Inductors for Power Lines

Inductors for General Circuits

RF Inductors
 LQG15HS_02

Continued from the preceding page. ↘

Part Number (□: packaging code)	Inductance	Inductance Test Frequency	Q (min.)	Q Test Frequency	Rated Current	Max. of DC Resistance	S.R.F.* (min.)
LQG15HS5N1S02□	5.1nH ±0.3nH	100MHz	8	100MHz	650mA	0.18Ω	5300MHz
LQG15HS5N6B02□	5.6nH ±0.1nH	100MHz	8	100MHz	650mA	0.18Ω	4500MHz
LQG15HS5N6C02□	5.6nH ±0.2nH	100MHz	8	100MHz	650mA	0.18Ω	4500MHz
LQG15HS5N6S02□	5.6nH ±0.3nH	100MHz	8	100MHz	650mA	0.18Ω	4500MHz
LQG15HS6N2B02□	6.2nH ±0.1nH	100MHz	8	100MHz	600mA	0.2Ω	4500MHz
LQG15HS6N2C02□	6.2nH ±0.2nH	100MHz	8	100MHz	600mA	0.2Ω	4500MHz
LQG15HS6N2S02□	6.2nH ±0.3nH	100MHz	8	100MHz	600mA	0.2Ω	4500MHz
LQG15HS6N8G02□	6.8nH ±2%	100MHz	8	100MHz	600mA	0.22Ω	4500MHz
LQG15HS6N8H02□	6.8nH ±3%	100MHz	8	100MHz	600mA	0.22Ω	4500MHz
LQG15HS6N8J02□	6.8nH ±5%	100MHz	8	100MHz	600mA	0.22Ω	4500MHz
LQG15HS7N5G02□	7.5nH ±2%	100MHz	8	100MHz	550mA	0.24Ω	4200MHz
LQG15HS7N5H02□	7.5nH ±3%	100MHz	8	100MHz	550mA	0.24Ω	4200MHz
LQG15HS7N5J02□	7.5nH ±5%	100MHz	8	100MHz	550mA	0.24Ω	4200MHz
LQG15HS8N2G02□	8.2nH ±2%	100MHz	8	100MHz	550mA	0.24Ω	3700MHz
LQG15HS8N2H02□	8.2nH ±3%	100MHz	8	100MHz	550mA	0.24Ω	3700MHz
LQG15HS8N2J02□	8.2nH ±5%	100MHz	8	100MHz	550mA	0.24Ω	3700MHz
LQG15HS9N1G02□	9.1nH ±2%	100MHz	8	100MHz	500mA	0.26Ω	3400MHz
LQG15HS9N1H02□	9.1nH ±3%	100MHz	8	100MHz	500mA	0.26Ω	3400MHz
LQG15HS9N1J02□	9.1nH ±5%	100MHz	8	100MHz	500mA	0.26Ω	3400MHz
LQG15HS10NG02□	10nH ±2%	100MHz	8	100MHz	500mA	0.26Ω	3400MHz
LQG15HS10NH02□	10nH ±3%	100MHz	8	100MHz	500mA	0.26Ω	3400MHz
LQG15HS10NJ02□	10nH ±5%	100MHz	8	100MHz	500mA	0.26Ω	3400MHz
LQG15HS12NG02□	12nH ±2%	100MHz	8	100MHz	500mA	0.28Ω	3000MHz
LQG15HS12NH02□	12nH ±3%	100MHz	8	100MHz	500mA	0.28Ω	3000MHz
LQG15HS12NJ02□	12nH ±5%	100MHz	8	100MHz	500mA	0.28Ω	3000MHz
LQG15HS15NG02□	15nH ±2%	100MHz	8	100MHz	450mA	0.32Ω	2500MHz
LQG15HS15NH02□	15nH ±3%	100MHz	8	100MHz	450mA	0.32Ω	2500MHz
LQG15HS15NJ02□	15nH ±5%	100MHz	8	100MHz	450mA	0.32Ω	2500MHz
LQG15HS18NG02□	18nH ±2%	100MHz	8	100MHz	400mA	0.36Ω	2200MHz
LQG15HS18NH02□	18nH ±3%	100MHz	8	100MHz	400mA	0.36Ω	2200MHz
LQG15HS18NJ02□	18nH ±5%	100MHz	8	100MHz	400mA	0.36Ω	2200MHz
LQG15HS22NG02□	22nH ±2%	100MHz	8	100MHz	350mA	0.42Ω	1900MHz
LQG15HS22NH02□	22nH ±3%	100MHz	8	100MHz	350mA	0.42Ω	1900MHz
LQG15HS22NJ02□	22nH ±5%	100MHz	8	100MHz	350mA	0.42Ω	1900MHz
LQG15HS27NG02□	27nH ±2%	100MHz	8	100MHz	350mA	0.46Ω	1700MHz
LQG15HS27NH02□	27nH ±3%	100MHz	8	100MHz	350mA	0.46Ω	1700MHz
LQG15HS27NJ02□	27nH ±5%	100MHz	8	100MHz	350mA	0.46Ω	1700MHz
LQG15HS33NG02□	33nH ±2%	100MHz	8	100MHz	350mA	0.58Ω	1600MHz
LQG15HS33NH02□	33nH ±3%	100MHz	8	100MHz	350mA	0.58Ω	1600MHz
LQG15HS33NJ02□	33nH ±5%	100MHz	8	100MHz	350mA	0.58Ω	1600MHz
LQG15HS39NG02□	39nH ±2%	100MHz	8	100MHz	300mA	0.65Ω	1200MHz
LQG15HS39NH02□	39nH ±3%	100MHz	8	100MHz	300mA	0.65Ω	1200MHz
LQG15HS39NJ02□	39nH ±5%	100MHz	8	100MHz	300mA	0.65Ω	1200MHz
LQG15HS47NG02□	47nH ±2%	100MHz	8	100MHz	300mA	0.72Ω	1000MHz
LQG15HS47NH02□	47nH ±3%	100MHz	8	100MHz	300mA	0.72Ω	1000MHz
LQG15HS47NJ02□	47nH ±5%	100MHz	8	100MHz	300mA	0.72Ω	1000MHz
LQG15HS56NG02□	56nH ±2%	100MHz	8	100MHz	250mA	0.82Ω	800MHz
LQG15HS56NH02□	56nH ±3%	100MHz	8	100MHz	250mA	0.82Ω	800MHz
LQG15HS56NJ02□	56nH ±5%	100MHz	8	100MHz	250mA	0.82Ω	800MHz
LQG15HS68NG02□	68nH ±2%	100MHz	8	100MHz	250mA	0.92Ω	800MHz
LQG15HS68NH02□	68nH ±3%	100MHz	8	100MHz	250mA	0.92Ω	800MHz
LQG15HS68NJ02□	68nH ±5%	100MHz	8	100MHz	250mA	0.92Ω	800MHz
LQG15HS82NG02□	82nH ±2%	100MHz	8	100MHz	200mA	1.2Ω	700MHz

Operating temp. range: -55 to 125°C
 Only for reflow soldering
 *S.R.F.: Self Resonant Frequency

Continued on the following page. ↗

Inductors for Power Lines

Inductors for General Circuits

LQG15HS_02
RF Inductors

Continued from the preceding page. ↘

Part Number (□: packaging code)	Inductance	Inductance Test Frequency	Q (min.)	Q Test Frequency	Rated Current	Max. of DC Resistance	S.R.F.* (min.)
LQG15HS82NH02□	82nH ±3%	100MHz	8	100MHz	200mA	1.2Ω	700MHz
LQG15HS82NJ02□	82nH ±5%	100MHz	8	100MHz	200mA	1.2Ω	700MHz
LQG15HSR10G02□	100nH ±2%	100MHz	8	100MHz	200mA	1.25Ω	600MHz
LQG15HSR10H02□	100nH ±3%	100MHz	8	100MHz	200mA	1.25Ω	600MHz
LQG15HSR10J02□	100nH ±5%	100MHz	8	100MHz	200mA	1.25Ω	600MHz
LQG15HSR12G02□	120nH ±2%	100MHz	8	100MHz	200mA	1.3Ω	600MHz
LQG15HSR12H02□	120nH ±3%	100MHz	8	100MHz	200mA	1.3Ω	600MHz
LQG15HSR12J02□	120nH ±5%	100MHz	8	100MHz	200mA	1.3Ω	600MHz
LQG15HSR15G02□	150nH ±2%	100MHz	8	100MHz	150mA	2.99Ω	550MHz
LQG15HSR15H02□	150nH ±3%	100MHz	8	100MHz	150mA	2.99Ω	550MHz
LQG15HSR15J02□	150nH ±5%	100MHz	8	100MHz	150mA	2.99Ω	550MHz
LQG15HSR18G02□	180nH ±2%	100MHz	8	100MHz	150mA	3.38Ω	500MHz
LQG15HSR18H02□	180nH ±3%	100MHz	8	100MHz	150mA	3.38Ω	500MHz
LQG15HSR18J02□	180nH ±5%	100MHz	8	100MHz	150mA	3.38Ω	500MHz
LQG15HSR22G02□	220nH ±2%	100MHz	8	100MHz	120mA	3.77Ω	450MHz
LQG15HSR22H02□	220nH ±3%	100MHz	8	100MHz	120mA	3.77Ω	450MHz
LQG15HSR22J02□	220nH ±5%	100MHz	8	100MHz	120mA	3.77Ω	450MHz
LQG15HSR27G02□	270nH ±2%	100MHz	8	100MHz	110mA	4.94Ω	400MHz
LQG15HSR27H02□	270nH ±3%	100MHz	8	100MHz	110mA	4.94Ω	400MHz
LQG15HSR27J02□	270nH ±5%	100MHz	8	100MHz	110mA	4.94Ω	400MHz

Operating temp. range: -55 to 125°C
 Only for reflow soldering
 *S.R.F.: Self Resonant Frequency

Inductance-Frequency Characteristics (Typ.)



Q-Frequency Characteristics (Typ.)



LQG18HN_00 Series 0603 (1608) inch (mm)



(in mm)

Packaging Code	Packaging	Minimum Quantity
D	ø180mm Paper Taping	4000
J	ø330mm Paper Taping	10000
B	Packing in Bulk	1000

Continued on the following page. ↗

Continued from the preceding page. ↘

Part Number (□: packaging code)	Inductance	Inductance Test Frequency	Q (min.)	Q Test Frequency	Rated Current	Max. of DC Resistance	S.R.F.* (min.)
LQG18HN1N2500□	1.2nH ±0.3nH	100MHz	12	100MHz	1100mA	0.10Ω	6000MHz
LQG18HN1N5000□	1.5nH ±0.3nH	100MHz	12	100MHz	1100mA	0.10Ω	6000MHz
LQG18HN1N8500□	1.8nH ±0.3nH	100MHz	12	100MHz	1100mA	0.10Ω	6000MHz
LQG18HN2N2500□	2.2nH ±0.3nH	100MHz	12	100MHz	1100mA	0.10Ω	6000MHz
LQG18HN2N7500□	2.7nH ±0.3nH	100MHz	12	100MHz	1000mA	0.12Ω	6000MHz
LQG18HN3N3500□	3.3nH ±0.3nH	100MHz	12	100MHz	1000mA	0.12Ω	6000MHz
LQG18HN3N9500□	3.9nH ±0.3nH	100MHz	12	100MHz	900mA	0.15Ω	6000MHz
LQG18HN4N7500□	4.7nH ±0.3nH	100MHz	12	100MHz	900mA	0.15Ω	6000MHz
LQG18HN5N6500□	5.6nH ±0.3nH	100MHz	12	100MHz	800mA	0.20Ω	5000MHz
LQG18HN6N8J00□	6.8nH ±5%	100MHz	12	100MHz	800mA	0.20Ω	5000MHz
LQG18HN8N2J00□	8.2nH ±5%	100MHz	12	100MHz	800mA	0.20Ω	4000MHz
LQG18HN10NJ00□	10nH ±5%	100MHz	12	100MHz	650mA	0.30Ω	3500MHz
LQG18HN12NJ00□	12nH ±5%	100MHz	12	100MHz	600mA	0.35Ω	3000MHz
LQG18HN15NJ00□	15nH ±5%	100MHz	12	100MHz	600mA	0.35Ω	2800MHz
LQG18HN18NJ00□	18nH ±5%	100MHz	12	100MHz	600mA	0.37Ω	2600MHz
LQG18HN22NJ00□	22nH ±5%	100MHz	12	100MHz	500mA	0.50Ω	2300MHz
LQG18HN27NJ00□	27nH ±5%	100MHz	12	100MHz	500mA	0.54Ω	2000MHz
LQG18HN33NJ00□	33nH ±5%	100MHz	12	100MHz	500mA	0.54Ω	1700MHz
LQG18HN39NJ00□	39nH ±5%	100MHz	12	100MHz	450mA	0.60Ω	1500MHz
LQG18HN47NJ00□	47nH ±5%	100MHz	12	100MHz	400mA	0.70Ω	1200MHz
LQG18HN56NJ00□	56nH ±5%	100MHz	12	100MHz	400mA	0.75Ω	1100MHz
LQG18HN68NJ00□	68nH ±5%	100MHz	12	100MHz	400mA	0.80Ω	1000MHz
LQG18HN82NJ00□	82nH ±5%	100MHz	12	100MHz	350mA	0.85Ω	900MHz
LQG18HNR10J00□	100nH ±5%	100MHz	12	100MHz	350mA	0.90Ω	800MHz

Operating temp. range: -40 to 85°C

Only for reflow soldering

*S.R.F.: Self Resonant Frequency

Inductance-Frequency Characteristics (Typ.)



Q-Frequency Characteristics (Typ.)



LQP02HQ_02 Series 01005 (0402) inch (mm)



Packaging Code	Packaging	Minimum Quantity
E	ø180mm Embossed Taping	15000
L	ø180mm Embossed Taping	30000
B	Packing in Bulk	500

Continued on the following page. ↗

Continued from the preceding page. ↘

Part Number (□: packaging code)	Inductance	Inductance Test Frequency	Q (min.)	Q Test Frequency	Rated Current	Max. of DC Resistance	S.R.F.* (min.)
LQP02HQ0N2W02□	0.2nH ±0.05nH	500MHz	-	500MHz	1000mA	0.01Ω	17.0GHz
LQP02HQ0N2B02□	0.2nH ±0.1nH	500MHz	-	500MHz	1000mA	0.01Ω	17.0GHz
LQP02HQ0N2C02□	0.2nH ±0.2nH	500MHz	-	500MHz	1000mA	0.01Ω	17.0GHz
LQP02HQ0N3W02□	0.3nH ±0.05nH	500MHz	-	500MHz	1000mA	0.02Ω	17.0GHz
LQP02HQ0N3B02□	0.3nH ±0.1nH	500MHz	-	500MHz	1000mA	0.02Ω	17.0GHz
LQP02HQ0N3C02□	0.3nH ±0.2nH	500MHz	-	500MHz	1000mA	0.02Ω	17.0GHz
LQP02HQ0N4W02□	0.4nH ±0.05nH	500MHz	14	500MHz	1000mA	0.03Ω	17.0GHz
LQP02HQ0N4B02□	0.4nH ±0.1nH	500MHz	14	500MHz	1000mA	0.03Ω	17.0GHz
LQP02HQ0N4C02□	0.4nH ±0.2nH	500MHz	14	500MHz	1000mA	0.03Ω	17.0GHz
LQP02HQ0N5W02□	0.5nH ±0.05nH	500MHz	14	500MHz	1000mA	0.04Ω	17.0GHz
LQP02HQ0N5B02□	0.5nH ±0.1nH	500MHz	14	500MHz	1000mA	0.04Ω	17.0GHz
LQP02HQ0N5C02□	0.5nH ±0.2nH	500MHz	14	500MHz	1000mA	0.04Ω	17.0GHz
LQP02HQ0N6W02□	0.6nH ±0.05nH	500MHz	14	500MHz	950mA	0.05Ω	17.0GHz
LQP02HQ0N6B02□	0.6nH ±0.1nH	500MHz	14	500MHz	950mA	0.05Ω	17.0GHz
LQP02HQ0N6C02□	0.6nH ±0.2nH	500MHz	14	500MHz	950mA	0.05Ω	17.0GHz
LQP02HQ0N7W02□	0.7nH ±0.05nH	500MHz	14	500MHz	900mA	0.05Ω	15.5GHz
LQP02HQ0N7B02□	0.7nH ±0.1nH	500MHz	14	500MHz	900mA	0.05Ω	15.5GHz
LQP02HQ0N7C02□	0.7nH ±0.2nH	500MHz	14	500MHz	900mA	0.05Ω	15.5GHz
LQP02HQ0N8W02□	0.8nH ±0.05nH	500MHz	14	500MHz	900mA	0.05Ω	15.5GHz
LQP02HQ0N8B02□	0.8nH ±0.1nH	500MHz	14	500MHz	900mA	0.05Ω	15.5GHz
LQP02HQ0N8C02□	0.8nH ±0.2nH	500MHz	14	500MHz	900mA	0.05Ω	15.5GHz
LQP02HQ0N9W02□	0.9nH ±0.05nH	500MHz	14	500MHz	900mA	0.05Ω	14.6GHz
LQP02HQ0N9B02□	0.9nH ±0.1nH	500MHz	14	500MHz	900mA	0.05Ω	14.6GHz
LQP02HQ0N9C02□	0.9nH ±0.2nH	500MHz	14	500MHz	900mA	0.05Ω	14.6GHz
LQP02HQ1N0W02□	1.0nH ±0.05nH	500MHz	14	500MHz	900mA	0.05Ω	13.2GHz
LQP02HQ1N0B02□	1.0nH ±0.1nH	500MHz	14	500MHz	900mA	0.05Ω	13.2GHz
LQP02HQ1N0C02□	1.0nH ±0.2nH	500MHz	14	500MHz	900mA	0.05Ω	13.2GHz
LQP02HQ1N1W02□	1.1nH ±0.05nH	500MHz	14	500MHz	850mA	0.06Ω	12.8GHz
LQP02HQ1N1B02□	1.1nH ±0.1nH	500MHz	14	500MHz	850mA	0.06Ω	12.8GHz
LQP02HQ1N1C02□	1.1nH ±0.2nH	500MHz	14	500MHz	850mA	0.06Ω	12.8GHz
LQP02HQ1N2W02□	1.2nH ±0.05nH	500MHz	14	500MHz	800mA	0.06Ω	12.8GHz
LQP02HQ1N2B02□	1.2nH ±0.1nH	500MHz	14	500MHz	800mA	0.06Ω	12.8GHz
LQP02HQ1N2C02□	1.2nH ±0.2nH	500MHz	14	500MHz	800mA	0.06Ω	12.8GHz
LQP02HQ1N3W02□	1.3nH ±0.05nH	500MHz	14	500MHz	700mA	0.08Ω	12.7GHz
LQP02HQ1N3B02□	1.3nH ±0.1nH	500MHz	14	500MHz	700mA	0.08Ω	12.7GHz
LQP02HQ1N3C02□	1.3nH ±0.2nH	500MHz	14	500MHz	700mA	0.08Ω	12.7GHz
LQP02HQ1N4W02□	1.4nH ±0.05nH	500MHz	14	500MHz	700mA	0.08Ω	12.7GHz
LQP02HQ1N4B02□	1.4nH ±0.1nH	500MHz	14	500MHz	700mA	0.08Ω	12.7GHz
LQP02HQ1N4C02□	1.4nH ±0.2nH	500MHz	14	500MHz	700mA	0.08Ω	12.7GHz
LQP02HQ1N5W02□	1.5nH ±0.05nH	500MHz	14	500MHz	700mA	0.08Ω	12.7GHz
LQP02HQ1N5B02□	1.5nH ±0.1nH	500MHz	14	500MHz	700mA	0.08Ω	12.7GHz
LQP02HQ1N5C02□	1.5nH ±0.2nH	500MHz	14	500MHz	700mA	0.08Ω	12.7GHz
LQP02HQ1N6B02□	1.6nH ±0.1nH	500MHz	14	500MHz	700mA	0.08Ω	10.7GHz
LQP02HQ1N6C02□	1.6nH ±0.2nH	500MHz	14	500MHz	700mA	0.08Ω	10.7GHz
LQP02HQ1N7B02□	1.7nH ±0.1nH	500MHz	14	500MHz	700mA	0.08Ω	10.7GHz
LQP02HQ1N7C02□	1.7nH ±0.2nH	500MHz	14	500MHz	700mA	0.08Ω	10.7GHz
LQP02HQ1N8B02□	1.8nH ±0.1nH	500MHz	14	500MHz	700mA	0.08Ω	10.2GHz
LQP02HQ1N8C02□	1.8nH ±0.2nH	500MHz	14	500MHz	700mA	0.08Ω	10.2GHz
LQP02HQ1N9B02□	1.9nH ±0.1nH	500MHz	14	500MHz	700mA	0.08Ω	10.2GHz
LQP02HQ1N9C02□	1.9nH ±0.2nH	500MHz	14	500MHz	700mA	0.08Ω	10.2GHz
LQP02HQ2N0B02□	2.0nH ±0.1nH	500MHz	14	500MHz	700mA	0.1Ω	10.1GHz
LQP02HQ2N0C02□	2.0nH ±0.2nH	500MHz	14	500MHz	700mA	0.1Ω	10.1GHz
LQP02HQ2N1B02□	2.1nH ±0.1nH	500MHz	14	500MHz	650mA	0.1Ω	10.1GHz

Operating temp. range: -55 to 125°C
 Only for reflow soldering
 *S.R.F.: Self Resonant Frequency

Continued on the following page. ↗

Inductors for Power Lines

Inductors for General Circuits

RF Inductors
 LQP02HQ_02

Continued from the preceding page. ↘

Part Number (□: packaging code)	Inductance	Inductance Test Frequency	Q (min.)	Q Test Frequency	Rated Current	Max. of DC Resistance	S.R.F.* (min.)
LQP02HQ2N1C02□	2.1nH ±0.2nH	500MHz	14	500MHz	650mA	0.1Ω	10.1GHz
LQP02HQ2N2B02□	2.2nH ±0.1nH	500MHz	14	500MHz	500mA	0.2Ω	9.8GHz
LQP02HQ2N2C02□	2.2nH ±0.2nH	500MHz	14	500MHz	500mA	0.2Ω	9.8GHz
LQP02HQ2N3B02□	2.3nH ±0.1nH	500MHz	14	500MHz	450mA	0.2Ω	9.8GHz
LQP02HQ2N3C02□	2.3nH ±0.2nH	500MHz	14	500MHz	450mA	0.2Ω	9.8GHz
LQP02HQ2N4B02□	2.4nH ±0.1nH	500MHz	14	500MHz	450mA	0.2Ω	9.5GHz
LQP02HQ2N4C02□	2.4nH ±0.2nH	500MHz	14	500MHz	450mA	0.2Ω	9.5GHz
LQP02HQ2N5B02□	2.5nH ±0.1nH	500MHz	14	500MHz	450mA	0.2Ω	9.5GHz
LQP02HQ2N5C02□	2.5nH ±0.2nH	500MHz	14	500MHz	450mA	0.2Ω	9.5GHz
LQP02HQ2N6B02□	2.6nH ±0.1nH	500MHz	14	500MHz	450mA	0.2Ω	9.5GHz
LQP02HQ2N6C02□	2.6nH ±0.2nH	500MHz	14	500MHz	450mA	0.2Ω	9.5GHz
LQP02HQ2N7B02□	2.7nH ±0.1nH	500MHz	14	500MHz	450mA	0.2Ω	8.8GHz
LQP02HQ2N7C02□	2.7nH ±0.2nH	500MHz	14	500MHz	450mA	0.2Ω	8.8GHz
LQP02HQ2N8B02□	2.8nH ±0.1nH	500MHz	14	500MHz	450mA	0.2Ω	8.8GHz
LQP02HQ2N8C02□	2.8nH ±0.2nH	500MHz	14	500MHz	450mA	0.2Ω	8.8GHz
LQP02HQ2N9B02□	2.9nH ±0.1nH	500MHz	14	500MHz	450mA	0.2Ω	8.8GHz
LQP02HQ2N9C02□	2.9nH ±0.2nH	500MHz	14	500MHz	450mA	0.2Ω	8.8GHz
LQP02HQ3N0B02□	3.0nH ±0.1nH	500MHz	14	500MHz	450mA	0.2Ω	8.5GHz
LQP02HQ3N0C02□	3.0nH ±0.2nH	500MHz	14	500MHz	450mA	0.2Ω	8.5GHz
LQP02HQ3N1B02□	3.1nH ±0.1nH	500MHz	14	500MHz	400mA	0.25Ω	8.5GHz
LQP02HQ3N1C02□	3.1nH ±0.2nH	500MHz	14	500MHz	400mA	0.25Ω	8.5GHz
LQP02HQ3N2B02□	3.2nH ±0.1nH	500MHz	14	500MHz	400mA	0.25Ω	8.5GHz
LQP02HQ3N2C02□	3.2nH ±0.2nH	500MHz	14	500MHz	400mA	0.25Ω	8.5GHz
LQP02HQ3N3B02□	3.3nH ±0.1nH	500MHz	14	500MHz	400mA	0.25Ω	8.2GHz
LQP02HQ3N3C02□	3.3nH ±0.2nH	500MHz	14	500MHz	400mA	0.25Ω	8.2GHz
LQP02HQ3N4B02□	3.4nH ±0.1nH	500MHz	14	500MHz	400mA	0.3Ω	8.2GHz
LQP02HQ3N4C02□	3.4nH ±0.2nH	500MHz	14	500MHz	400mA	0.3Ω	8.2GHz
LQP02HQ3N5B02□	3.5nH ±0.1nH	500MHz	14	500MHz	350mA	0.3Ω	8.2GHz
LQP02HQ3N5C02□	3.5nH ±0.2nH	500MHz	14	500MHz	350mA	0.3Ω	8.2GHz
LQP02HQ3N6B02□	3.6nH ±0.1nH	500MHz	14	500MHz	350mA	0.3Ω	8.2GHz
LQP02HQ3N6C02□	3.6nH ±0.2nH	500MHz	14	500MHz	350mA	0.3Ω	8.2GHz
LQP02HQ3N7B02□	3.7nH ±0.1nH	500MHz	14	500MHz	350mA	0.35Ω	8.2GHz
LQP02HQ3N7C02□	3.7nH ±0.2nH	500MHz	14	500MHz	350mA	0.35Ω	8.2GHz
LQP02HQ3N8B02□	3.8nH ±0.1nH	500MHz	14	500MHz	350mA	0.35Ω	8.2GHz
LQP02HQ3N8C02□	3.8nH ±0.2nH	500MHz	14	500MHz	350mA	0.35Ω	8.2GHz
LQP02HQ3N9B02□	3.9nH ±0.1nH	500MHz	14	500MHz	350mA	0.35Ω	7.7GHz
LQP02HQ3N9C02□	3.9nH ±0.2nH	500MHz	14	500MHz	350mA	0.35Ω	7.7GHz
LQP02HQ4N0B02□	4.0nH ±0.1nH	500MHz	14	500MHz	350mA	0.35Ω	6.9GHz
LQP02HQ4N0C02□	4.0nH ±0.2nH	500MHz	14	500MHz	350mA	0.35Ω	6.9GHz
LQP02HQ4N1B02□	4.1nH ±0.1nH	500MHz	14	500MHz	350mA	0.35Ω	6.9GHz
LQP02HQ4N1C02□	4.1nH ±0.2nH	500MHz	14	500MHz	350mA	0.35Ω	6.9GHz
LQP02HQ4N2B02□	4.2nH ±0.1nH	500MHz	14	500MHz	350mA	0.35Ω	6.9GHz
LQP02HQ4N2C02□	4.2nH ±0.2nH	500MHz	14	500MHz	350mA	0.35Ω	6.9GHz
LQP02HQ4N3H02□	4.3nH ±3%	500MHz	13	500MHz	350mA	0.35Ω	6.9GHz
LQP02HQ4N3J02□	4.3nH ±5%	500MHz	13	500MHz	350mA	0.35Ω	6.9GHz
LQP02HQ4N7H02□	4.7nH ±3%	500MHz	13	500MHz	350mA	0.35Ω	6.7GHz
LQP02HQ4N7J02□	4.7nH ±5%	500MHz	13	500MHz	350mA	0.35Ω	6.7GHz
LQP02HQ5N1H02□	5.1nH ±3%	500MHz	13	500MHz	350mA	0.35Ω	6.6GHz
LQP02HQ5N1J02□	5.1nH ±5%	500MHz	13	500MHz	350mA	0.35Ω	6.6GHz
LQP02HQ5N6H02□	5.6nH ±3%	500MHz	13	500MHz	300mA	0.4Ω	6.1GHz
LQP02HQ5N6J02□	5.6nH ±5%	500MHz	13	500MHz	300mA	0.4Ω	6.1GHz
LQP02HQ6N2H02□	6.2nH ±3%	500MHz	13	500MHz	300mA	0.4Ω	6.0GHz
LQP02HQ6N2J02□	6.2nH ±5%	500MHz	13	500MHz	300mA	0.4Ω	6.0GHz

Operating temp. range: -55 to 125°C
 Only for reflow soldering
 *S.R.F.: Self Resonant Frequency

Continued on the following page. ↗

Continued from the preceding page. ↘

Part Number (□: packaging code)	Inductance	Inductance Test Frequency	Q (min.)	Q Test Frequency	Rated Current	Max. of DC Resistance	S.R.F.* (min.)
LQP02HQ6N8H02□	6.8nH ±3%	500MHz	13	500MHz	300mA	0.4Ω	5.7GHz
LQP02HQ6N8J02□	6.8nH ±5%	500MHz	13	500MHz	300mA	0.4Ω	5.7GHz
LQP02HQ7N5H02□	7.5nH ±3%	500MHz	13	500MHz	300mA	0.5Ω	5.6GHz
LQP02HQ7N5J02□	7.5nH ±5%	500MHz	13	500MHz	300mA	0.5Ω	5.6GHz
LQP02HQ8N2H02□	8.2nH ±3%	500MHz	13	500MHz	300mA	0.5Ω	5.1GHz
LQP02HQ8N2J02□	8.2nH ±5%	500MHz	13	500MHz	300mA	0.5Ω	5.1GHz
LQP02HQ9N1H02□	9.1nH ±3%	500MHz	13	500MHz	300mA	0.5Ω	4.9GHz
LQP02HQ9N1J02□	9.1nH ±5%	500MHz	13	500MHz	300mA	0.5Ω	4.9GHz
LQP02HQ10NH02□	10nH ±3%	500MHz	13	500MHz	250mA	0.6Ω	4.9GHz
LQP02HQ10NJ02□	10nH ±5%	500MHz	13	500MHz	250mA	0.6Ω	4.9GHz
LQP02HQ11NH02□	11nH ±3%	500MHz	13	500MHz	250mA	0.8Ω	4.0GHz
LQP02HQ11NJ02□	11nH ±5%	500MHz	13	500MHz	250mA	0.8Ω	4.0GHz
LQP02HQ12NH02□	12nH ±3%	500MHz	13	500MHz	230mA	0.82Ω	4.0GHz
LQP02HQ12NJ02□	12nH ±5%	500MHz	13	500MHz	230mA	0.82Ω	4.0GHz
LQP02HQ13NH02□	13nH ±3%	500MHz	13	500MHz	210mA	0.99Ω	4.0GHz
LQP02HQ13NJ02□	13nH ±5%	500MHz	13	500MHz	210mA	0.99Ω	4.0GHz
LQP02HQ15NH02□	15nH ±3%	500MHz	13	500MHz	170mA	1.53Ω	4.0GHz
LQP02HQ15NJ02□	15nH ±5%	500MHz	13	500MHz	170mA	1.53Ω	4.0GHz
LQP02HQ16NH02□	16nH ±3%	500MHz	13	500MHz	170mA	1.53Ω	4.0GHz
LQP02HQ16NJ02□	16nH ±5%	500MHz	13	500MHz	170mA	1.53Ω	4.0GHz
LQP02HQ18NH02□	18nH ±3%	500MHz	13	500MHz	160mA	1.63Ω	3.7GHz
LQP02HQ18NJ02□	18nH ±5%	500MHz	13	500MHz	160mA	1.63Ω	3.7GHz
LQP02HQ20NH02□	20nH ±3%	500MHz	12	500MHz	140mA	2.26Ω	3.0GHz
LQP02HQ20NJ02□	20nH ±5%	500MHz	12	500MHz	140mA	2.26Ω	3.0GHz
LQP02HQ22NH02□	22nH ±3%	500MHz	12	500MHz	140mA	2.26Ω	3.0GHz
LQP02HQ22NJ02□	22nH ±5%	500MHz	12	500MHz	140mA	2.26Ω	3.0GHz
LQP02HQ24NH02□	24nH ±3%	500MHz	12	500MHz	120mA	2.6Ω	2.9GHz
LQP02HQ24NJ02□	24nH ±5%	500MHz	12	500MHz	120mA	2.6Ω	2.9GHz
LQP02HQ27NH02□	27nH ±3%	500MHz	12	500MHz	120mA	2.6Ω	2.9GHz
LQP02HQ27NJ02□	27nH ±5%	500MHz	12	500MHz	120mA	2.6Ω	2.9GHz
LQP02HQ30NH02□	30nH ±3%	500MHz	9	500MHz	120mA	3.2Ω	2.6GHz
LQP02HQ30NJ02□	30nH ±5%	500MHz	9	500MHz	120mA	3.2Ω	2.6GHz
LQP02HQ33NH02□	33nH ±3%	300MHz	9	300MHz	120mA	3.2Ω	2.6GHz
LQP02HQ33NJ02□	33nH ±5%	300MHz	9	300MHz	120mA	3.2Ω	2.6GHz
LQP02HQ36NH02□	36nH ±3%	300MHz	9	300MHz	110mA	3.6Ω	2.4GHz
LQP02HQ36NJ02□	36nH ±5%	300MHz	9	300MHz	110mA	3.6Ω	2.4GHz
LQP02HQ39NH02□	39nH ±3%	300MHz	9	300MHz	110mA	3.6Ω	2.4GHz
LQP02HQ39NJ02□	39nH ±5%	300MHz	9	300MHz	110mA	3.6Ω	2.4GHz
LQP02HQ43NH02□	43nH ±3%	300MHz	8	300MHz	100mA	4.0Ω	2.1GHz
LQP02HQ43NJ02□	43nH ±5%	300MHz	8	300MHz	100mA	4.0Ω	2.1GHz
LQP02HQ47NH02□	47nH ±3%	300MHz	8	300MHz	100mA	4.0Ω	2.1GHz
LQP02HQ47NJ02□	47nH ±5%	300MHz	8	300MHz	100mA	4.0Ω	2.1GHz
LQP02HQ51NH02□	51nH ±3%	300MHz	8	300MHz	100mA	4.2Ω	1.9GHz
LQP02HQ51NJ02□	51nH ±5%	300MHz	8	300MHz	100mA	4.2Ω	1.9GHz
LQP02HQ56NH02□	56nH ±3%	300MHz	8	300MHz	100mA	4.2Ω	1.9GHz
LQP02HQ56NJ02□	56nH ±5%	300MHz	8	300MHz	100mA	4.2Ω	1.9GHz

Operating temp. range: -55 to 125°C

Only for reflow soldering

*S.R.F.: Self Resonant Frequency

Continued on the following page. ↗

Inductors for Power Lines

Inductors for General Circuits

RF Inductors
LQP02HQ_02

Continued from the preceding page. ↘

Inductance-Frequency Characteristics (Typ.)



Q-Frequency Characteristics (Typ.)



LQP02TN_02 Series 01005 (0402) inch (mm)



Packaging Code	Packaging	Minimum Quantity
D	ø180mm Paper Taping	20000
L	ø180mm Embossed Taping	40000
B	Packing in Bulk	500

Part Number (□: packaging code)	Inductance	Inductance Test Frequency	Q (min.)	Q Test Frequency	Rated Current	Max. of DC Resistance	S.R.F.* (min.)
LQP02TN0N2B02□	0.2nH ±0.1nH	500MHz	-	500MHz	320mA	0.50Ω	20000MHz
LQP02TN0N2C02□	0.2nH ±0.2nH	500MHz	-	500MHz	320mA	0.50Ω	20000MHz
LQP02TN0N3B02□	0.3nH ±0.1nH	500MHz	-	500MHz	320mA	0.50Ω	20000MHz
LQP02TN0N3C02□	0.3nH ±0.2nH	500MHz	-	500MHz	320mA	0.50Ω	20000MHz
LQP02TN0N4B02□	0.4nH ±0.1nH	500MHz	8	500MHz	320mA	0.50Ω	18000MHz
LQP02TN0N4C02□	0.4nH ±0.2nH	500MHz	8	500MHz	320mA	0.50Ω	18000MHz
LQP02TN0N5B02□	0.5nH ±0.1nH	500MHz	8	500MHz	320mA	0.50Ω	18000MHz
LQP02TN0N5C02□	0.5nH ±0.2nH	500MHz	8	500MHz	320mA	0.50Ω	18000MHz
LQP02TN0N6B02□	0.6nH ±0.1nH	500MHz	8	500MHz	320mA	0.50Ω	17000MHz
LQP02TN0N6C02□	0.6nH ±0.2nH	500MHz	8	500MHz	320mA	0.50Ω	17000MHz
LQP02TN0N7B02□	0.7nH ±0.1nH	500MHz	8	500MHz	320mA	0.50Ω	16500MHz
LQP02TN0N7C02□	0.7nH ±0.2nH	500MHz	8	500MHz	320mA	0.50Ω	16500MHz
LQP02TN0N8B02□	0.8nH ±0.1nH	500MHz	8	500MHz	320mA	0.50Ω	16500MHz
LQP02TN0N8C02□	0.8nH ±0.2nH	500MHz	8	500MHz	320mA	0.50Ω	16500MHz
LQP02TN0N9B02□	0.9nH ±0.1nH	500MHz	8	500MHz	320mA	0.50Ω	13000MHz
LQP02TN0N9C02□	0.9nH ±0.2nH	500MHz	8	500MHz	320mA	0.50Ω	13000MHz
LQP02TN1N0B02□	1.0nH ±0.1nH	500MHz	8	500MHz	220mA	0.60Ω	13000MHz
LQP02TN1N0C02□	1.0nH ±0.2nH	500MHz	8	500MHz	220mA	0.60Ω	13000MHz
LQP02TN1N1B02□	1.1nH ±0.1nH	500MHz	8	500MHz	220mA	0.60Ω	12500MHz
LQP02TN1N1C02□	1.1nH ±0.2nH	500MHz	8	500MHz	220mA	0.60Ω	12500MHz
LQP02TN1N2B02□	1.2nH ±0.1nH	500MHz	8	500MHz	220mA	0.60Ω	12500MHz
LQP02TN1N2C02□	1.2nH ±0.2nH	500MHz	8	500MHz	220mA	0.60Ω	12500MHz
LQP02TN1N3B02□	1.3nH ±0.1nH	500MHz	8	500MHz	220mA	0.60Ω	11500MHz
LQP02TN1N3C02□	1.3nH ±0.2nH	500MHz	8	500MHz	220mA	0.60Ω	11500MHz
LQP02TN1N4B02□	1.4nH ±0.1nH	500MHz	8	500MHz	220mA	0.60Ω	11500MHz
LQP02TN1N4C02□	1.4nH ±0.2nH	500MHz	8	500MHz	220mA	0.60Ω	11500MHz

Operating temp. range: -55 to 125°C

Only for reflow soldering

*S.R.F.: Self Resonant Frequency

Continued on the following page. ↗

Continued from the preceding page. ↘

Part Number (□: packaging code)	Inductance	Inductance Test Frequency	Q (min.)	Q Test Frequency	Rated Current	Max. of DC Resistance	S.R.F.* (min.)
LQP02TN1N5B02□	1.5nH ±0.1nH	500MHz	8	500MHz	220mA	0.60Ω	9500MHz
LQP02TN1N5C02□	1.5nH ±0.2nH	500MHz	8	500MHz	220mA	0.60Ω	9500MHz
LQP02TN1N6B02□	1.6nH ±0.1nH	500MHz	8	500MHz	220mA	0.60Ω	9500MHz
LQP02TN1N6C02□	1.6nH ±0.2nH	500MHz	8	500MHz	220mA	0.60Ω	9500MHz
LQP02TN1N7B02□	1.7nH ±0.1nH	500MHz	8	500MHz	200mA	0.70Ω	9500MHz
LQP02TN1N7C02□	1.7nH ±0.2nH	500MHz	8	500MHz	200mA	0.70Ω	9500MHz
LQP02TN1N8B02□	1.8nH ±0.1nH	500MHz	8	500MHz	200mA	0.70Ω	9000MHz
LQP02TN1N8C02□	1.8nH ±0.2nH	500MHz	8	500MHz	200mA	0.70Ω	9000MHz
LQP02TN1N9B02□	1.9nH ±0.1nH	500MHz	8	500MHz	200mA	0.75Ω	9000MHz
LQP02TN1N9C02□	1.9nH ±0.2nH	500MHz	8	500MHz	200mA	0.75Ω	9000MHz
LQP02TN2N0B02□	2.0nH ±0.1nH	500MHz	8	500MHz	200mA	0.75Ω	9000MHz
LQP02TN2N0C02□	2.0nH ±0.2nH	500MHz	8	500MHz	200mA	0.75Ω	9000MHz
LQP02TN2N1B02□	2.1nH ±0.1nH	500MHz	8	500MHz	200mA	0.75Ω	9000MHz
LQP02TN2N1C02□	2.1nH ±0.2nH	500MHz	8	500MHz	200mA	0.75Ω	9000MHz
LQP02TN2N2B02□	2.2nH ±0.1nH	500MHz	8	500MHz	200mA	0.75Ω	7500MHz
LQP02TN2N2C02□	2.2nH ±0.2nH	500MHz	8	500MHz	200mA	0.75Ω	7500MHz
LQP02TN2N3B02□	2.3nH ±0.1nH	500MHz	8	500MHz	200mA	0.75Ω	7500MHz
LQP02TN2N3C02□	2.3nH ±0.2nH	500MHz	8	500MHz	200mA	0.75Ω	7500MHz
LQP02TN2N4B02□	2.4nH ±0.1nH	500MHz	8	500MHz	200mA	0.75Ω	7500MHz
LQP02TN2N4C02□	2.4nH ±0.2nH	500MHz	8	500MHz	200mA	0.75Ω	7500MHz
LQP02TN2N5B02□	2.5nH ±0.1nH	500MHz	8	500MHz	200mA	0.80Ω	7500MHz
LQP02TN2N5C02□	2.5nH ±0.2nH	500MHz	8	500MHz	200mA	0.80Ω	7500MHz
LQP02TN2N6B02□	2.6nH ±0.1nH	500MHz	8	500MHz	200mA	0.80Ω	7500MHz
LQP02TN2N6C02□	2.6nH ±0.2nH	500MHz	8	500MHz	200mA	0.80Ω	7500MHz
LQP02TN2N7B02□	2.7nH ±0.1nH	500MHz	8	500MHz	200mA	0.80Ω	7500MHz
LQP02TN2N7C02□	2.7nH ±0.2nH	500MHz	8	500MHz	200mA	0.80Ω	7500MHz
LQP02TN2N8B02□	2.8nH ±0.1nH	500MHz	8	500MHz	200mA	1.10Ω	7500MHz
LQP02TN2N8C02□	2.8nH ±0.2nH	500MHz	8	500MHz	200mA	1.10Ω	7500MHz
LQP02TN2N9B02□	2.9nH ±0.1nH	500MHz	8	500MHz	200mA	1.10Ω	7500MHz
LQP02TN2N9C02□	2.9nH ±0.2nH	500MHz	8	500MHz	200mA	1.10Ω	7500MHz
LQP02TN3N0B02□	3.0nH ±0.1nH	500MHz	8	500MHz	200mA	1.10Ω	7500MHz
LQP02TN3N0C02□	3.0nH ±0.2nH	500MHz	8	500MHz	200mA	1.10Ω	7500MHz
LQP02TN3N1B02□	3.1nH ±0.1nH	500MHz	8	500MHz	180mA	1.30Ω	7500MHz
LQP02TN3N1C02□	3.1nH ±0.2nH	500MHz	8	500MHz	180mA	1.30Ω	7500MHz
LQP02TN3N2B02□	3.2nH ±0.1nH	500MHz	8	500MHz	180mA	1.30Ω	7500MHz
LQP02TN3N2C02□	3.2nH ±0.2nH	500MHz	8	500MHz	180mA	1.30Ω	7500MHz
LQP02TN3N3B02□	3.3nH ±0.1nH	500MHz	8	500MHz	180mA	1.30Ω	7500MHz
LQP02TN3N3C02□	3.3nH ±0.2nH	500MHz	8	500MHz	180mA	1.30Ω	7500MHz
LQP02TN3N4B02□	3.4nH ±0.1nH	500MHz	8	500MHz	180mA	1.30Ω	7500MHz
LQP02TN3N4C02□	3.4nH ±0.2nH	500MHz	8	500MHz	180mA	1.30Ω	7500MHz
LQP02TN3N5B02□	3.5nH ±0.1nH	500MHz	8	500MHz	180mA	1.30Ω	7500MHz
LQP02TN3N5C02□	3.5nH ±0.2nH	500MHz	8	500MHz	180mA	1.30Ω	7500MHz
LQP02TN3N6B02□	3.6nH ±0.1nH	500MHz	8	500MHz	180mA	1.30Ω	7500MHz
LQP02TN3N6C02□	3.6nH ±0.2nH	500MHz	8	500MHz	180mA	1.30Ω	7500MHz
LQP02TN3N7B02□	3.7nH ±0.1nH	500MHz	8	500MHz	180mA	1.30Ω	7500MHz
LQP02TN3N7C02□	3.7nH ±0.2nH	500MHz	8	500MHz	180mA	1.30Ω	7500MHz
LQP02TN3N8B02□	3.8nH ±0.1nH	500MHz	8	500MHz	180mA	1.30Ω	7500MHz
LQP02TN3N8C02□	3.8nH ±0.2nH	500MHz	8	500MHz	180mA	1.30Ω	7500MHz
LQP02TN3N9B02□	3.9nH ±0.1nH	500MHz	8	500MHz	180mA	1.30Ω	7500MHz
LQP02TN3N9C02□	3.9nH ±0.2nH	500MHz	8	500MHz	180mA	1.30Ω	7500MHz
LQP02TN4N0B02□	4.0nH ±0.1nH	500MHz	8	500MHz	180mA	1.30Ω	7500MHz
LQP02TN4N0C02□	4.0nH ±0.2nH	500MHz	8	500MHz	180mA	1.30Ω	7500MHz
LQP02TN4N1B02□	4.1nH ±0.1nH	500MHz	8	500MHz	180mA	1.30Ω	7500MHz

Operating temp. range: -55 to 125°C
 Only for reflow soldering
 *S.R.F.: Self Resonant Frequency

Continued on the following page. ↗

Inductors for Power Lines

Inductors for General Circuits

RF Inductors
 LQP02TN_02

Continued from the preceding page. ↘

Part Number (□: packaging code)	Inductance	Inductance Test Frequency	Q (min.)	Q Test Frequency	Rated Current	Max. of DC Resistance	S.R.F.* (min.)
LQP02TN4N1C02□	4.1nH ±0.2nH	500MHz	8	500MHz	180mA	1.30Ω	7500MHz
LQP02TN4N2B02□	4.2nH ±0.1nH	500MHz	8	500MHz	180mA	1.30Ω	7000MHz
LQP02TN4N2C02□	4.2nH ±0.2nH	500MHz	8	500MHz	180mA	1.30Ω	7000MHz
LQP02TN4N3H02□	4.3nH ±3%	500MHz	8	500MHz	180mA	1.30Ω	7000MHz
LQP02TN4N3J02□	4.3nH ±5%	500MHz	8	500MHz	180mA	1.30Ω	7000MHz
LQP02TN4N7H02□	4.7nH ±3%	500MHz	8	500MHz	160mA	1.50Ω	6500MHz
LQP02TN4N7J02□	4.7nH ±5%	500MHz	8	500MHz	160mA	1.50Ω	6500MHz
LQP02TN5N1H02□	5.1nH ±3%	500MHz	8	500MHz	160mA	1.50Ω	6500MHz
LQP02TN5N1J02□	5.1nH ±5%	500MHz	8	500MHz	160mA	1.50Ω	6500MHz
LQP02TN5N6H02□	5.6nH ±3%	500MHz	8	500MHz	140mA	1.80Ω	6000MHz
LQP02TN5N6J02□	5.6nH ±5%	500MHz	8	500MHz	140mA	1.80Ω	6000MHz
LQP02TN6N2H02□	6.2nH ±3%	500MHz	8	500MHz	140mA	1.80Ω	5500MHz
LQP02TN6N2J02□	6.2nH ±5%	500MHz	8	500MHz	140mA	1.80Ω	5500MHz
LQP02TN6N8H02□	6.8nH ±3%	500MHz	8	500MHz	140mA	2.00Ω	5500MHz
LQP02TN6N8J02□	6.8nH ±5%	500MHz	8	500MHz	140mA	2.00Ω	5500MHz
LQP02TN7N5H02□	7.5nH ±3%	500MHz	8	500MHz	140mA	2.00Ω	4500MHz
LQP02TN7N5J02□	7.5nH ±5%	500MHz	8	500MHz	140mA	2.00Ω	4500MHz
LQP02TN8N2H02□	8.2nH ±3%	500MHz	8	500MHz	140mA	2.10Ω	4500MHz
LQP02TN8N2J02□	8.2nH ±5%	500MHz	8	500MHz	140mA	2.10Ω	4500MHz
LQP02TN9N1H02□	9.1nH ±3%	500MHz	8	500MHz	140mA	2.10Ω	4000MHz
LQP02TN9N1J02□	9.1nH ±5%	500MHz	8	500MHz	140mA	2.10Ω	4000MHz
LQP02TN10NH02□	10nH ±3%	500MHz	8	500MHz	140mA	2.50Ω	4000MHz
LQP02TN10NJ02□	10nH ±5%	500MHz	8	500MHz	140mA	2.50Ω	4000MHz
LQP02TN11NH02□	11nH ±3%	500MHz	7	500MHz	140mA	2.80Ω	3500MHz
LQP02TN11NJ02□	11nH ±5%	500MHz	7	500MHz	140mA	2.80Ω	3500MHz
LQP02TN12NH02□	12nH ±3%	500MHz	7	500MHz	140mA	2.80Ω	3500MHz
LQP02TN12NJ02□	12nH ±5%	500MHz	7	500MHz	140mA	2.80Ω	3500MHz
LQP02TN13NH02□	13nH ±3%	500MHz	7	500MHz	140mA	3.20Ω	3000MHz
LQP02TN13NJ02□	13nH ±5%	500MHz	7	500MHz	140mA	3.20Ω	3000MHz
LQP02TN15NH02□	15nH ±3%	500MHz	7	500MHz	140mA	3.20Ω	3000MHz
LQP02TN15NJ02□	15nH ±5%	500MHz	7	500MHz	140mA	3.20Ω	3000MHz
LQP02TN16NH02□	16nH ±3%	500MHz	7	500MHz	140mA	3.50Ω	2500MHz
LQP02TN16NJ02□	16nH ±5%	500MHz	7	500MHz	140mA	3.50Ω	2500MHz
LQP02TN18NH02□	18nH ±3%	500MHz	7	500MHz	140mA	3.50Ω	2500MHz
LQP02TN18NJ02□	18nH ±5%	500MHz	7	500MHz	140mA	3.50Ω	2500MHz
LQP02TN20NH02□	20nH ±3%	500MHz	6	500MHz	120mA	5.00Ω	2300MHz
LQP02TN20NJ02□	20nH ±5%	500MHz	6	500MHz	120mA	5.00Ω	2300MHz
LQP02TN22NH02□	22nH ±3%	500MHz	6	500MHz	120mA	5.00Ω	2300MHz
LQP02TN22NJ02□	22nH ±5%	500MHz	6	500MHz	120mA	5.00Ω	2300MHz
LQP02TN24NH02□	24nH ±3%	500MHz	6	500MHz	120mA	5.50Ω	2000MHz
LQP02TN24NJ02□	24nH ±5%	500MHz	6	500MHz	120mA	5.50Ω	2000MHz
LQP02TN27NH02□	27nH ±3%	500MHz	6	500MHz	120mA	5.50Ω	2000MHz
LQP02TN27NJ02□	27nH ±5%	500MHz	6	500MHz	120mA	5.50Ω	2000MHz
LQP02TN30NH02□	30nH ±3%	500MHz	6	500MHz	90mA	6.50Ω	1800MHz
LQP02TN30NJ02□	30nH ±5%	500MHz	6	500MHz	90mA	6.50Ω	1800MHz
LQP02TN33NH02□	33nH ±3%	300MHz	4	300MHz	90mA	6.50Ω	1800MHz
LQP02TN33NJ02□	33nH ±5%	300MHz	4	300MHz	90mA	6.50Ω	1800MHz
LQP02TN36NH02□	36nH ±3%	300MHz	4	300MHz	90mA	7.00Ω	1600MHz
LQP02TN36NJ02□	36nH ±5%	300MHz	4	300MHz	90mA	7.00Ω	1600MHz
LQP02TN39NH02□	39nH ±3%	300MHz	4	300MHz	90mA	7.00Ω	1600MHz
LQP02TN39NJ02□	39nH ±5%	300MHz	4	300MHz	90mA	7.00Ω	1600MHz

Operating temp. range: -55 to 125°C

Only for reflow soldering

*S.R.F.: Self Resonant Frequency

Continued on the following page. ↗

Inductors for Power Lines

Inductors for General Circuits

LQP02TN_02
RF Inductors

Continued from the preceding page. ↘

Inductance-Frequency Characteristics (Typ.)



Q-Frequency Characteristics (Typ.)



LQP02TQ_02 Series 01005 (0402) inch (mm)



Packaging Code	Packaging	Minimum Quantity
D	ø180mm Paper Taping	20000
L	ø180mm Embossed Taping	40000
B	Packing in Bulk	500

Part Number (□: packaging code)	Inductance	Inductance Test Frequency	Q (min.)	Q Test Frequency	Rated Current	Max. of DC Resistance	S.R.F.* (min.)
LQP02TQ0N2B02□	0.2nH ±0.1nH	500MHz	-	500MHz	990mA	0.1Ω	16.6GHz
LQP02TQ0N2C02□	0.2nH ±0.2nH	500MHz	-	500MHz	990mA	0.1Ω	16.6GHz
LQP02TQ0N3B02□	0.3nH ±0.1nH	500MHz	-	500MHz	990mA	0.1Ω	16.6GHz
LQP02TQ0N3C02□	0.3nH ±0.2nH	500MHz	-	500MHz	990mA	0.1Ω	16.6GHz
LQP02TQ0N4B02□	0.4nH ±0.1nH	500MHz	10	500MHz	990mA	0.1Ω	16.6GHz
LQP02TQ0N4C02□	0.4nH ±0.2nH	500MHz	10	500MHz	990mA	0.1Ω	16.6GHz
LQP02TQ0N5B02□	0.5nH ±0.1nH	500MHz	10	500MHz	730mA	0.1Ω	16.6GHz
LQP02TQ0N5C02□	0.5nH ±0.2nH	500MHz	10	500MHz	730mA	0.1Ω	16.6GHz
LQP02TQ0N6B02□	0.6nH ±0.1nH	500MHz	10	500MHz	730mA	0.1Ω	16.6GHz
LQP02TQ0N6C02□	0.6nH ±0.2nH	500MHz	10	500MHz	730mA	0.1Ω	16.6GHz
LQP02TQ0N7B02□	0.7nH ±0.1nH	500MHz	10	500MHz	630mA	0.15Ω	16.6GHz
LQP02TQ0N7C02□	0.7nH ±0.2nH	500MHz	10	500MHz	630mA	0.15Ω	16.6GHz
LQP02TQ0N8B02□	0.8nH ±0.1nH	500MHz	10	500MHz	630mA	0.15Ω	16.6GHz
LQP02TQ0N8C02□	0.8nH ±0.2nH	500MHz	10	500MHz	630mA	0.15Ω	16.6GHz
LQP02TQ0N9B02□	0.9nH ±0.1nH	500MHz	10	500MHz	580mA	0.15Ω	16.6GHz
LQP02TQ0N9C02□	0.9nH ±0.2nH	500MHz	10	500MHz	580mA	0.15Ω	16.6GHz
LQP02TQ1N0B02□	1.0nH ±0.1nH	500MHz	10	500MHz	580mA	0.15Ω	16.6GHz
LQP02TQ1N0C02□	1.0nH ±0.2nH	500MHz	10	500MHz	580mA	0.15Ω	16.6GHz
LQP02TQ1N1B02□	1.1nH ±0.1nH	500MHz	10	500MHz	570mA	0.2Ω	16.6GHz
LQP02TQ1N1C02□	1.1nH ±0.2nH	500MHz	10	500MHz	570mA	0.2Ω	16.6GHz
LQP02TQ1N2B02□	1.2nH ±0.1nH	500MHz	10	500MHz	550mA	0.2Ω	16.6GHz
LQP02TQ1N2C02□	1.2nH ±0.2nH	500MHz	10	500MHz	550mA	0.2Ω	16.6GHz
LQP02TQ1N3B02□	1.3nH ±0.1nH	500MHz	10	500MHz	400mA	0.2Ω	15.0GHz
LQP02TQ1N3C02□	1.3nH ±0.2nH	500MHz	10	500MHz	400mA	0.2Ω	15.0GHz
LQP02TQ1N4B02□	1.4nH ±0.1nH	500MHz	10	500MHz	400mA	0.2Ω	15.0GHz
LQP02TQ1N4C02□	1.4nH ±0.2nH	500MHz	10	500MHz	400mA	0.2Ω	15.0GHz

Operating temp. range: -55 to 125°C
 Only for reflow soldering
 *S.R.F.: Self Resonant Frequency

Continued from the preceding page. ↘

Part Number (□: packaging code)	Inductance	Inductance Test Frequency	Q (min.)	Q Test Frequency	Rated Current	Max. of DC Resistance	S.R.F.* (min.)
LQP02TQ1N5B02□	1.5nH ±0.1nH	500MHz	10	500MHz	400mA	0.2Ω	15.0GHz
LQP02TQ1N5C02□	1.5nH ±0.2nH	500MHz	10	500MHz	400mA	0.2Ω	15.0GHz
LQP02TQ1N6B02□	1.6nH ±0.1nH	500MHz	10	500MHz	390mA	0.3Ω	15.0GHz
LQP02TQ1N6C02□	1.6nH ±0.2nH	500MHz	10	500MHz	390mA	0.3Ω	15.0GHz
LQP02TQ1N7B02□	1.7nH ±0.1nH	500MHz	10	500MHz	380mA	0.3Ω	15.0GHz
LQP02TQ1N7C02□	1.7nH ±0.2nH	500MHz	10	500MHz	380mA	0.3Ω	15.0GHz
LQP02TQ1N8B02□	1.8nH ±0.1nH	500MHz	10	500MHz	380mA	0.3Ω	15.0GHz
LQP02TQ1N8C02□	1.8nH ±0.2nH	500MHz	10	500MHz	380mA	0.3Ω	15.0GHz
LQP02TQ1N9B02□	1.9nH ±0.1nH	500MHz	10	500MHz	380mA	0.3Ω	13.0GHz
LQP02TQ1N9C02□	1.9nH ±0.2nH	500MHz	10	500MHz	380mA	0.3Ω	13.0GHz
LQP02TQ2N0B02□	2.0nH ±0.1nH	500MHz	10	500MHz	380mA	0.3Ω	13.0GHz
LQP02TQ2N0C02□	2.0nH ±0.2nH	500MHz	10	500MHz	380mA	0.3Ω	13.0GHz
LQP02TQ2N1B02□	2.1nH ±0.1nH	500MHz	10	500MHz	380mA	0.3Ω	13.0GHz
LQP02TQ2N1C02□	2.1nH ±0.2nH	500MHz	10	500MHz	380mA	0.3Ω	13.0GHz
LQP02TQ2N2B02□	2.2nH ±0.1nH	500MHz	10	500MHz	380mA	0.3Ω	13.0GHz
LQP02TQ2N2C02□	2.2nH ±0.2nH	500MHz	10	500MHz	380mA	0.3Ω	13.0GHz
LQP02TQ2N3B02□	2.3nH ±0.1nH	500MHz	10	500MHz	370mA	0.4Ω	13.0GHz
LQP02TQ2N3C02□	2.3nH ±0.2nH	500MHz	10	500MHz	370mA	0.4Ω	13.0GHz
LQP02TQ2N4B02□	2.4nH ±0.1nH	500MHz	10	500MHz	370mA	0.4Ω	13.0GHz
LQP02TQ2N4C02□	2.4nH ±0.2nH	500MHz	10	500MHz	370mA	0.4Ω	13.0GHz
LQP02TQ2N5B02□	2.5nH ±0.1nH	500MHz	10	500MHz	370mA	0.4Ω	11.5GHz
LQP02TQ2N5C02□	2.5nH ±0.2nH	500MHz	10	500MHz	370mA	0.4Ω	11.5GHz
LQP02TQ2N6B02□	2.6nH ±0.1nH	500MHz	10	500MHz	370mA	0.4Ω	11.5GHz
LQP02TQ2N6C02□	2.6nH ±0.2nH	500MHz	10	500MHz	370mA	0.4Ω	11.5GHz
LQP02TQ2N7B02□	2.7nH ±0.1nH	500MHz	10	500MHz	370mA	0.4Ω	11.5GHz
LQP02TQ2N7C02□	2.7nH ±0.2nH	500MHz	10	500MHz	370mA	0.4Ω	11.5GHz
LQP02TQ2N8B02□	2.8nH ±0.1nH	500MHz	10	500MHz	360mA	0.45Ω	10.0GHz
LQP02TQ2N8C02□	2.8nH ±0.2nH	500MHz	10	500MHz	360mA	0.45Ω	10.0GHz
LQP02TQ2N9B02□	2.9nH ±0.1nH	500MHz	10	500MHz	360mA	0.45Ω	10.0GHz
LQP02TQ2N9C02□	2.9nH ±0.2nH	500MHz	10	500MHz	360mA	0.45Ω	10.0GHz
LQP02TQ3N0B02□	3.0nH ±0.1nH	500MHz	10	500MHz	360mA	0.45Ω	10.0GHz
LQP02TQ3N0C02□	3.0nH ±0.2nH	500MHz	10	500MHz	360mA	0.45Ω	10.0GHz
LQP02TQ3N1B02□	3.1nH ±0.1nH	500MHz	10	500MHz	290mA	0.9Ω	10.0GHz
LQP02TQ3N1C02□	3.1nH ±0.2nH	500MHz	10	500MHz	290mA	0.9Ω	10.0GHz
LQP02TQ3N2B02□	3.2nH ±0.1nH	500MHz	10	500MHz	290mA	0.9Ω	10.0GHz
LQP02TQ3N2C02□	3.2nH ±0.2nH	500MHz	10	500MHz	290mA	0.9Ω	10.0GHz
LQP02TQ3N3B02□	3.3nH ±0.1nH	500MHz	10	500MHz	290mA	0.9Ω	10.0GHz
LQP02TQ3N3C02□	3.3nH ±0.2nH	500MHz	10	500MHz	290mA	0.9Ω	10.0GHz
LQP02TQ3N4B02□	3.4nH ±0.1nH	500MHz	10	500MHz	280mA	1.0Ω	9.7GHz
LQP02TQ3N4C02□	3.4nH ±0.2nH	500MHz	10	500MHz	280mA	1.0Ω	9.7GHz
LQP02TQ3N5B02□	3.5nH ±0.1nH	500MHz	10	500MHz	280mA	1.0Ω	9.7GHz
LQP02TQ3N5C02□	3.5nH ±0.2nH	500MHz	10	500MHz	280mA	1.0Ω	9.7GHz
LQP02TQ3N6B02□	3.6nH ±0.1nH	500MHz	10	500MHz	280mA	1.0Ω	9.7GHz
LQP02TQ3N6C02□	3.6nH ±0.2nH	500MHz	10	500MHz	280mA	1.0Ω	9.7GHz
LQP02TQ3N7B02□	3.7nH ±0.1nH	500MHz	10	500MHz	270mA	1.0Ω	9.7GHz
LQP02TQ3N7C02□	3.7nH ±0.2nH	500MHz	10	500MHz	270mA	1.0Ω	9.7GHz
LQP02TQ3N8B02□	3.8nH ±0.1nH	500MHz	10	500MHz	270mA	1.0Ω	9.7GHz
LQP02TQ3N8C02□	3.8nH ±0.2nH	500MHz	10	500MHz	270mA	1.0Ω	9.7GHz
LQP02TQ3N9B02□	3.9nH ±0.1nH	500MHz	10	500MHz	270mA	1.0Ω	9.0GHz
LQP02TQ3N9C02□	3.9nH ±0.2nH	500MHz	10	500MHz	270mA	1.0Ω	9.0GHz
LQP02TQ4N0B02□	4.0nH ±0.1nH	500MHz	10	500MHz	270mA	1.0Ω	9.0GHz
LQP02TQ4N0C02□	4.0nH ±0.2nH	500MHz	10	500MHz	270mA	1.0Ω	9.0GHz
LQP02TQ4N1B02□	4.1nH ±0.1nH	500MHz	10	500MHz	270mA	1.0Ω	9.0GHz

Operating temp. range: -55 to 125°C
 Only for reflow soldering
 *S.R.F.: Self Resonant Frequency

Continued on the following page. ↗

Inductors for Power Lines

Inductors for General Circuits

LQP02TQ_02
RF Inductors

Continued from the preceding page. ↘

Part Number (□: packaging code)	Inductance	Inductance Test Frequency	Q (min.)	Q Test Frequency	Rated Current	Max. of DC Resistance	S.R.F.* (min.)
LQP02TQ4N1C02□	4.1nH ±0.2nH	500MHz	10	500MHz	270mA	1.0Ω	9.0GHz
LQP02TQ4N2B02□	4.2nH ±0.1nH	500MHz	10	500MHz	270mA	1.0Ω	9.0GHz
LQP02TQ4N2C02□	4.2nH ±0.2nH	500MHz	10	500MHz	270mA	1.0Ω	9.0GHz
LQP02TQ4N3H02□	4.3nH ±3%	500MHz	10	500MHz	270mA	1.0Ω	9.0GHz
LQP02TQ4N3J02□	4.3nH ±5%	500MHz	10	500MHz	270mA	1.0Ω	9.0GHz
LQP02TQ4N7H02□	4.7nH ±3%	500MHz	10	500MHz	270mA	1.0Ω	8.5GHz
LQP02TQ4N7J02□	4.7nH ±5%	500MHz	10	500MHz	270mA	1.0Ω	8.5GHz
LQP02TQ5N1H02□	5.1nH ±3%	500MHz	10	500MHz	250mA	1.2Ω	7.8GHz
LQP02TQ5N1J02□	5.1nH ±5%	500MHz	10	500MHz	250mA	1.2Ω	7.8GHz
LQP02TQ5N6H02□	5.6nH ±3%	500MHz	10	500MHz	230mA	1.3Ω	7.8GHz
LQP02TQ5N6J02□	5.6nH ±5%	500MHz	10	500MHz	230mA	1.3Ω	7.8GHz
LQP02TQ6N2H02□	6.2nH ±3%	500MHz	10	500MHz	220mA	1.3Ω	7.2GHz
LQP02TQ6N2J02□	6.2nH ±5%	500MHz	10	500MHz	220mA	1.3Ω	7.2GHz
LQP02TQ6N8H02□	6.8nH ±3%	500MHz	10	500MHz	210mA	1.4Ω	6.6GHz
LQP02TQ6N8J02□	6.8nH ±5%	500MHz	10	500MHz	210mA	1.4Ω	6.6GHz
LQP02TQ7N5H02□	7.5nH ±3%	500MHz	10	500MHz	200mA	1.5Ω	6.6GHz
LQP02TQ7N5J02□	7.5nH ±5%	500MHz	10	500MHz	200mA	1.5Ω	6.6GHz
LQP02TQ8N2H02□	8.2nH ±3%	500MHz	10	500MHz	190mA	1.6Ω	6.6GHz
LQP02TQ8N2J02□	8.2nH ±5%	500MHz	10	500MHz	190mA	1.6Ω	6.6GHz
LQP02TQ9N1H02□	9.1nH ±3%	500MHz	10	500MHz	170mA	1.7Ω	5.9GHz
LQP02TQ9N1J02□	9.1nH ±5%	500MHz	10	500MHz	170mA	1.7Ω	5.9GHz
LQP02TQ10NH02□	10nH ±3%	500MHz	10	500MHz	170mA	1.7Ω	5.5GHz
LQP02TQ10NJ02□	10nH ±5%	500MHz	10	500MHz	170mA	1.7Ω	5.5GHz
LQP02TQ11NH02□	11nH ±3%	500MHz	10	500MHz	140mA	1.9Ω	3.5GHz
LQP02TQ11NJ02□	11nH ±5%	500MHz	10	500MHz	140mA	1.9Ω	3.5GHz
LQP02TQ12NH02□	12nH ±3%	500MHz	10	500MHz	140mA	2.1Ω	3.5GHz
LQP02TQ12NJ02□	12nH ±5%	500MHz	10	500MHz	140mA	2.1Ω	3.5GHz
LQP02TQ13NH02□	13nH ±3%	500MHz	10	500MHz	140mA	2.1Ω	3.0GHz
LQP02TQ13NJ02□	13nH ±5%	500MHz	10	500MHz	140mA	2.1Ω	3.0GHz
LQP02TQ14NH02□	14nH ±3%	500MHz	10	500MHz	140mA	2.3Ω	3.0GHz
LQP02TQ14NJ02□	14nH ±5%	500MHz	10	500MHz	140mA	2.3Ω	3.0GHz
LQP02TQ15NH02□	15nH ±3%	500MHz	10	500MHz	140mA	2.3Ω	3.0GHz
LQP02TQ15NJ02□	15nH ±5%	500MHz	10	500MHz	140mA	2.3Ω	3.0GHz
LQP02TQ16NH02□	16nH ±3%	500MHz	10	500MHz	140mA	2.5Ω	2.5GHz
LQP02TQ16NJ02□	16nH ±5%	500MHz	10	500MHz	140mA	2.5Ω	2.5GHz
LQP02TQ17NH02□	17nH ±3%	500MHz	10	500MHz	140mA	2.5Ω	2.5GHz
LQP02TQ17NJ02□	17nH ±5%	500MHz	10	500MHz	140mA	2.5Ω	2.5GHz
LQP02TQ18NH02□	18nH ±3%	500MHz	8	500MHz	140mA	2.5Ω	2.5GHz
LQP02TQ18NJ02□	18nH ±5%	500MHz	8	500MHz	140mA	2.5Ω	2.5GHz
LQP02TQ19NH02□	19nH ±3%	500MHz	8	500MHz	140mA	2.9Ω	2.7GHz
LQP02TQ19NJ02□	19nH ±5%	500MHz	8	500MHz	140mA	2.9Ω	2.7GHz
LQP02TQ20NH02□	20nH ±3%	500MHz	8	500MHz	140mA	2.9Ω	2.7GHz
LQP02TQ20NJ02□	20nH ±5%	500MHz	8	500MHz	140mA	2.9Ω	2.7GHz
LQP02TQ21NH02□	21nH ±3%	500MHz	8	500MHz	120mA	3.2Ω	2.3GHz
LQP02TQ21NJ02□	21nH ±5%	500MHz	8	500MHz	120mA	3.2Ω	2.3GHz
LQP02TQ22NH02□	22nH ±3%	500MHz	8	500MHz	120mA	3.2Ω	2.3GHz
LQP02TQ22NJ02□	22nH ±5%	500MHz	8	500MHz	120mA	3.2Ω	2.3GHz

Operating temp. range: -55 to 125°C

Only for reflow soldering

*S.R.F.: Self Resonant Frequency

Continued on the following page. ↗

Continued from the preceding page. ↘

Inductance-Frequency Characteristics (Typ.)



Q-Frequency Characteristics (Typ.)



LQP03HQ_02 Series 0201 (0603) inch (mm)



Packaging Code	Packaging	Minimum Quantity
D	ø180mm Paper Taping	15000
J	ø330mm Paper Taping	50000
B	Packing in Bulk	500

Part Number (□: packaging code)	Inductance	Inductance Test Frequency	Q (min.)	Q Test Frequency	Rated Current	Max. of DC Resistance	S.R.F.* (min.)
LQP03HQ0N6W02□	0.6nH ±0.05nH	500MHz	20	500MHz	1100mA	0.04Ω	20000MHz
LQP03HQ0N6B02□	0.6nH ±0.1nH	500MHz	20	500MHz	1100mA	0.04Ω	20000MHz
LQP03HQ0N6C02□	0.6nH ±0.2nH	500MHz	20	500MHz	1100mA	0.04Ω	20000MHz
LQP03HQ0N7W02□	0.7nH ±0.05nH	500MHz	20	500MHz	1100mA	0.04Ω	20000MHz
LQP03HQ0N7B02□	0.7nH ±0.1nH	500MHz	20	500MHz	1100mA	0.04Ω	20000MHz
LQP03HQ0N7C02□	0.7nH ±0.2nH	500MHz	20	500MHz	1100mA	0.04Ω	20000MHz
LQP03HQ0N8W02□	0.8nH ±0.05nH	500MHz	20	500MHz	1100mA	0.04Ω	18000MHz
LQP03HQ0N8B02□	0.8nH ±0.1nH	500MHz	20	500MHz	1100mA	0.04Ω	18000MHz
LQP03HQ0N8C02□	0.8nH ±0.2nH	500MHz	20	500MHz	1100mA	0.04Ω	18000MHz
LQP03HQ0N9W02□	0.9nH ±0.05nH	500MHz	20	500MHz	1100mA	0.04Ω	18000MHz
LQP03HQ0N9B02□	0.9nH ±0.1nH	500MHz	20	500MHz	1100mA	0.04Ω	18000MHz
LQP03HQ0N9C02□	0.9nH ±0.2nH	500MHz	20	500MHz	1100mA	0.04Ω	18000MHz
LQP03HQ1N0W02□	1.0nH ±0.05nH	500MHz	20	500MHz	1100mA	0.04Ω	16000MHz
LQP03HQ1N0B02□	1.0nH ±0.1nH	500MHz	20	500MHz	1100mA	0.04Ω	16000MHz
LQP03HQ1N0C02□	1.0nH ±0.2nH	500MHz	20	500MHz	1100mA	0.04Ω	16000MHz
LQP03HQ1N1W02□	1.1nH ±0.05nH	500MHz	20	500MHz	1100mA	0.04Ω	14000MHz
LQP03HQ1N1B02□	1.1nH ±0.1nH	500MHz	20	500MHz	1100mA	0.04Ω	14000MHz
LQP03HQ1N1C02□	1.1nH ±0.2nH	500MHz	20	500MHz	1100mA	0.04Ω	14000MHz
LQP03HQ1N2W02□	1.2nH ±0.05nH	500MHz	20	500MHz	1100mA	0.04Ω	13000MHz
LQP03HQ1N2B02□	1.2nH ±0.1nH	500MHz	20	500MHz	1100mA	0.04Ω	13000MHz
LQP03HQ1N2C02□	1.2nH ±0.2nH	500MHz	20	500MHz	1100mA	0.04Ω	13000MHz
LQP03HQ1N3B02□	1.3nH ±0.1nH	500MHz	20	500MHz	1100mA	0.04Ω	13000MHz
LQP03HQ1N3C02□	1.3nH ±0.2nH	500MHz	20	500MHz	1100mA	0.04Ω	13000MHz
LQP03HQ1N4B02□	1.4nH ±0.1nH	500MHz	20	500MHz	1100mA	0.04Ω	12000MHz
LQP03HQ1N4C02□	1.4nH ±0.2nH	500MHz	20	500MHz	1100mA	0.04Ω	12000MHz
LQP03HQ1N5B02□	1.5nH ±0.1nH	500MHz	20	500MHz	1000mA	0.05Ω	12000MHz

Operating temp. range: -55 to 125°C

Only for reflow soldering

*S.R.F.: Self Resonant Frequency

Continued on the following page. ↗

Continued from the preceding page. ↘

Part Number (□: packaging code)	Inductance	Inductance Test Frequency	Q (min.)	Q Test Frequency	Rated Current	Max. of DC Resistance	S.R.F.* (min.)
LQP03HQ1N5C02□	1.5nH ±0.2nH	500MHz	20	500MHz	1000mA	0.05Ω	12000MHz
LQP03HQ1N6B02□	1.6nH ±0.1nH	500MHz	20	500MHz	1000mA	0.05Ω	10000MHz
LQP03HQ1N6C02□	1.6nH ±0.2nH	500MHz	20	500MHz	1000mA	0.05Ω	10000MHz
LQP03HQ1N7B02□	1.7nH ±0.1nH	500MHz	20	500MHz	800mA	0.07Ω	10000MHz
LQP03HQ1N7C02□	1.7nH ±0.2nH	500MHz	20	500MHz	800mA	0.07Ω	10000MHz
LQP03HQ1N8B02□	1.8nH ±0.1nH	500MHz	20	500MHz	800mA	0.08Ω	10000MHz
LQP03HQ1N8C02□	1.8nH ±0.2nH	500MHz	20	500MHz	800mA	0.08Ω	10000MHz
LQP03HQ1N9B02□	1.9nH ±0.1nH	500MHz	20	500MHz	600mA	0.12Ω	10000MHz
LQP03HQ1N9C02□	1.9nH ±0.2nH	500MHz	20	500MHz	600mA	0.12Ω	10000MHz
LQP03HQ2N0B02□	2.0nH ±0.1nH	500MHz	20	500MHz	600mA	0.12Ω	9000MHz
LQP03HQ2N0C02□	2.0nH ±0.2nH	500MHz	20	500MHz	600mA	0.12Ω	9000MHz
LQP03HQ2N1B02□	2.1nH ±0.1nH	500MHz	20	500MHz	600mA	0.12Ω	9000MHz
LQP03HQ2N1C02□	2.1nH ±0.2nH	500MHz	20	500MHz	600mA	0.12Ω	9000MHz
LQP03HQ2N2B02□	2.2nH ±0.1nH	500MHz	20	500MHz	600mA	0.12Ω	9000MHz
LQP03HQ2N2C02□	2.2nH ±0.2nH	500MHz	20	500MHz	600mA	0.12Ω	9000MHz
LQP03HQ2N3B02□	2.3nH ±0.1nH	500MHz	20	500MHz	600mA	0.12Ω	9000MHz
LQP03HQ2N3C02□	2.3nH ±0.2nH	500MHz	20	500MHz	600mA	0.12Ω	9000MHz
LQP03HQ2N4B02□	2.4nH ±0.1nH	500MHz	20	500MHz	600mA	0.12Ω	9000MHz
LQP03HQ2N4C02□	2.4nH ±0.2nH	500MHz	20	500MHz	600mA	0.12Ω	9000MHz
LQP03HQ2N5B02□	2.5nH ±0.1nH	500MHz	20	500MHz	600mA	0.12Ω	9000MHz
LQP03HQ2N5C02□	2.5nH ±0.2nH	500MHz	20	500MHz	600mA	0.12Ω	9000MHz
LQP03HQ2N6B02□	2.6nH ±0.1nH	500MHz	20	500MHz	600mA	0.12Ω	9000MHz
LQP03HQ2N6C02□	2.6nH ±0.2nH	500MHz	20	500MHz	600mA	0.12Ω	9000MHz
LQP03HQ2N7B02□	2.7nH ±0.1nH	500MHz	20	500MHz	600mA	0.12Ω	9000MHz
LQP03HQ2N7C02□	2.7nH ±0.2nH	500MHz	20	500MHz	600mA	0.12Ω	9000MHz
LQP03HQ2N8B02□	2.8nH ±0.1nH	500MHz	20	500MHz	600mA	0.12Ω	8000MHz
LQP03HQ2N8C02□	2.8nH ±0.2nH	500MHz	20	500MHz	600mA	0.12Ω	8000MHz
LQP03HQ2N9B02□	2.9nH ±0.1nH	500MHz	20	500MHz	600mA	0.12Ω	8000MHz
LQP03HQ2N9C02□	2.9nH ±0.2nH	500MHz	20	500MHz	600mA	0.12Ω	8000MHz
LQP03HQ3N0B02□	3.0nH ±0.1nH	500MHz	20	500MHz	600mA	0.12Ω	8000MHz
LQP03HQ3N0C02□	3.0nH ±0.2nH	500MHz	20	500MHz	600mA	0.12Ω	8000MHz
LQP03HQ3N1B02□	3.1nH ±0.1nH	500MHz	20	500MHz	500mA	0.17Ω	7500MHz
LQP03HQ3N1C02□	3.1nH ±0.2nH	500MHz	20	500MHz	500mA	0.17Ω	7500MHz
LQP03HQ3N2B02□	3.2nH ±0.1nH	500MHz	20	500MHz	500mA	0.17Ω	7000MHz
LQP03HQ3N2C02□	3.2nH ±0.2nH	500MHz	20	500MHz	500mA	0.17Ω	7000MHz
LQP03HQ3N3B02□	3.3nH ±0.1nH	500MHz	20	500MHz	500mA	0.17Ω	7000MHz
LQP03HQ3N3C02□	3.3nH ±0.2nH	500MHz	20	500MHz	500mA	0.17Ω	7000MHz
LQP03HQ3N4B02□	3.4nH ±0.1nH	500MHz	20	500MHz	500mA	0.17Ω	7000MHz
LQP03HQ3N4C02□	3.4nH ±0.2nH	500MHz	20	500MHz	500mA	0.17Ω	7000MHz
LQP03HQ3N5B02□	3.5nH ±0.1nH	500MHz	20	500MHz	500mA	0.17Ω	7000MHz
LQP03HQ3N5C02□	3.5nH ±0.2nH	500MHz	20	500MHz	500mA	0.17Ω	7000MHz
LQP03HQ3N6B02□	3.6nH ±0.1nH	500MHz	20	500MHz	500mA	0.17Ω	7000MHz
LQP03HQ3N6C02□	3.6nH ±0.2nH	500MHz	20	500MHz	500mA	0.17Ω	7000MHz
LQP03HQ3N7B02□	3.7nH ±0.1nH	500MHz	20	500MHz	500mA	0.17Ω	7000MHz
LQP03HQ3N7C02□	3.7nH ±0.2nH	500MHz	20	500MHz	500mA	0.17Ω	7000MHz
LQP03HQ3N8B02□	3.8nH ±0.1nH	500MHz	20	500MHz	500mA	0.17Ω	7000MHz
LQP03HQ3N8C02□	3.8nH ±0.2nH	500MHz	20	500MHz	500mA	0.17Ω	7000MHz
LQP03HQ3N9B02□	3.9nH ±0.1nH	500MHz	20	500MHz	500mA	0.17Ω	7000MHz
LQP03HQ3N9C02□	3.9nH ±0.2nH	500MHz	20	500MHz	500mA	0.17Ω	7000MHz
LQP03HQ4N0B02□	4.0nH ±0.1nH	500MHz	20	500MHz	500mA	0.17Ω	7000MHz
LQP03HQ4N0C02□	4.0nH ±0.2nH	500MHz	20	500MHz	500mA	0.17Ω	7000MHz
LQP03HQ4N1B02□	4.1nH ±0.1nH	500MHz	20	500MHz	500mA	0.17Ω	7000MHz
LQP03HQ4N1C02□	4.1nH ±0.2nH	500MHz	20	500MHz	500mA	0.17Ω	7000MHz

Operating temp. range: -55 to 125°C
 Only for reflow soldering
 *S.R.F.: Self Resonant Frequency

Continued on the following page. ↗

Inductors for Power Lines

Inductors for General Circuits

RF Inductors
 LQP03HQ_02

Continued from the preceding page. ↘

Part Number (□: packaging code)	Inductance	Inductance Test Frequency	Q (min.)	Q Test Frequency	Rated Current	Max. of DC Resistance	S.R.F.* (min.)
LQP03HQ4N2B02□	4.2nH ±0.1nH	500MHz	20	500MHz	500mA	0.17Ω	7000MHz
LQP03HQ4N2C02□	4.2nH ±0.2nH	500MHz	20	500MHz	500mA	0.17Ω	7000MHz
LQP03HQ4N3H02□	4.3nH ±3%	500MHz	20	500MHz	500mA	0.17Ω	7000MHz
LQP03HQ4N3J02□	4.3nH ±5%	500MHz	20	500MHz	500mA	0.17Ω	7000MHz
LQP03HQ4N7H02□	4.7nH ±3%	500MHz	20	500MHz	400mA	0.25Ω	7000MHz
LQP03HQ4N7J02□	4.7nH ±5%	500MHz	20	500MHz	400mA	0.25Ω	7000MHz
LQP03HQ5N1H02□	5.1nH ±3%	500MHz	20	500MHz	400mA	0.25Ω	5500MHz
LQP03HQ5N1J02□	5.1nH ±5%	500MHz	20	500MHz	400mA	0.25Ω	5500MHz
LQP03HQ5N6H02□	5.6nH ±3%	500MHz	20	500MHz	400mA	0.25Ω	5500MHz
LQP03HQ5N6J02□	5.6nH ±5%	500MHz	20	500MHz	400mA	0.25Ω	5500MHz
LQP03HQ6N2H02□	6.2nH ±3%	500MHz	20	500MHz	400mA	0.25Ω	5500MHz
LQP03HQ6N2J02□	6.2nH ±5%	500MHz	20	500MHz	400mA	0.25Ω	5500MHz
LQP03HQ6N8H02□	6.8nH ±3%	500MHz	20	500MHz	400mA	0.3Ω	5500MHz
LQP03HQ6N8J02□	6.8nH ±5%	500MHz	20	500MHz	400mA	0.3Ω	5500MHz
LQP03HQ7N5H02□	7.5nH ±3%	500MHz	20	500MHz	400mA	0.3Ω	4500MHz
LQP03HQ7N5J02□	7.5nH ±5%	500MHz	20	500MHz	400mA	0.3Ω	4500MHz
LQP03HQ8N2H02□	8.2nH ±3%	500MHz	20	500MHz	300mA	0.4Ω	4500MHz
LQP03HQ8N2J02□	8.2nH ±5%	500MHz	20	500MHz	300mA	0.4Ω	4500MHz
LQP03HQ9N1H02□	9.1nH ±3%	500MHz	20	500MHz	300mA	0.4Ω	4500MHz
LQP03HQ9N1J02□	9.1nH ±5%	500MHz	20	500MHz	300mA	0.4Ω	4500MHz
LQP03HQ10NH02□	10nH ±3%	500MHz	20	500MHz	300mA	0.4Ω	4500MHz
LQP03HQ10NJ02□	10nH ±5%	500MHz	20	500MHz	300mA	0.4Ω	4500MHz
LQP03HQ11NH02□	11nH ±3%	500MHz	20	500MHz	300mA	0.5Ω	4000MHz
LQP03HQ11NJ02□	11nH ±5%	500MHz	20	500MHz	300mA	0.5Ω	4000MHz
LQP03HQ12NH02□	12nH ±3%	500MHz	20	500MHz	300mA	0.5Ω	4000MHz
LQP03HQ12NJ02□	12nH ±5%	500MHz	20	500MHz	300mA	0.5Ω	4000MHz
LQP03HQ13NH02□	13nH ±3%	500MHz	20	500MHz	300mA	0.5Ω	4000MHz
LQP03HQ13NJ02□	13nH ±5%	500MHz	20	500MHz	300mA	0.5Ω	4000MHz
LQP03HQ15NH02□	15nH ±3%	500MHz	20	500MHz	300mA	0.7Ω	3500MHz
LQP03HQ15NJ02□	15nH ±5%	500MHz	20	500MHz	300mA	0.7Ω	3500MHz
LQP03HQ16NH02□	16nH ±3%	500MHz	20	500MHz	250mA	0.8Ω	3500MHz
LQP03HQ16NJ02□	16nH ±5%	500MHz	20	500MHz	250mA	0.8Ω	3500MHz
LQP03HQ18NH02□	18nH ±3%	500MHz	20	500MHz	250mA	0.8Ω	3500MHz
LQP03HQ18NJ02□	18nH ±5%	500MHz	20	500MHz	250mA	0.8Ω	3500MHz
LQP03HQ20NH02□	20nH ±3%	500MHz	20	500MHz	250mA	0.8Ω	3000MHz
LQP03HQ20NJ02□	20nH ±5%	500MHz	20	500MHz	250mA	0.8Ω	3000MHz
LQP03HQ22NH02□	22nH ±3%	500MHz	20	500MHz	250mA	0.82Ω	3000MHz
LQP03HQ22NJ02□	22nH ±5%	500MHz	20	500MHz	250mA	0.82Ω	3000MHz
LQP03HQ24NH02□	24nH ±3%	500MHz	15	500MHz	170mA	1.6Ω	2000MHz
LQP03HQ24NJ02□	24nH ±5%	500MHz	15	500MHz	170mA	1.6Ω	2000MHz
LQP03HQ27NH02□	27nH ±3%	500MHz	15	500MHz	170mA	1.6Ω	2000MHz
LQP03HQ27NJ02□	27nH ±5%	500MHz	15	500MHz	170mA	1.6Ω	2000MHz
LQP03HQ30NH02□	30nH ±3%	500MHz	12	500MHz	150mA	2.0Ω	1700MHz
LQP03HQ30NJ02□	30nH ±5%	500MHz	12	500MHz	150mA	2.0Ω	1700MHz
LQP03HQ33NH02□	33nH ±3%	300MHz	12	300MHz	150mA	2.0Ω	1700MHz
LQP03HQ33NJ02□	33nH ±5%	300MHz	12	300MHz	150mA	2.0Ω	1700MHz
LQP03HQ36NH02□	36nH ±3%	300MHz	12	300MHz	150mA	2.0Ω	1500MHz
LQP03HQ36NJ02□	36nH ±5%	300MHz	12	300MHz	150mA	2.0Ω	1500MHz
LQP03HQ39NH02□	39nH ±3%	300MHz	12	300MHz	150mA	2.0Ω	1500MHz
LQP03HQ39NJ02□	39nH ±5%	300MHz	12	300MHz	150mA	2.0Ω	1500MHz
LQP03HQ43NH02□	43nH ±3%	300MHz	12	300MHz	130mA	2.5Ω	1300MHz
LQP03HQ43NJ02□	43nH ±5%	300MHz	12	300MHz	130mA	2.5Ω	1300MHz
LQP03HQ47NH02□	47nH ±3%	300MHz	12	300MHz	130mA	2.5Ω	1300MHz

Operating temp. range: -55 to 125°C
 Only for reflow soldering
 *S.R.F.: Self Resonant Frequency

Continued on the following page. ↗

Inductors for Power Lines

Inductors for General Circuits

LQP03HQ_02
RF Inductors

Continued from the preceding page. ↘

Part Number (□: packaging code)	Inductance	Inductance Test Frequency	Q (min.)	Q Test Frequency	Rated Current	Max. of DC Resistance	S.R.F.* (min.)
LQP03HQ47NJ02□	47nH ±5%	300MHz	12	300MHz	130mA	2.5Ω	1300MHz
LQP03HQ51NH02□	51nH ±3%	300MHz	12	300MHz	130mA	2.5Ω	1200MHz
LQP03HQ51NJ02□	51nH ±5%	300MHz	12	300MHz	130mA	2.5Ω	1200MHz
LQP03HQ56NH02□	56nH ±3%	300MHz	12	300MHz	130mA	2.5Ω	1200MHz
LQP03HQ56NJ02□	56nH ±5%	300MHz	12	300MHz	130mA	2.5Ω	1200MHz
LQP03HQ62NH02□	62nH ±3%	300MHz	12	300MHz	100mA	5.0Ω	1100MHz
LQP03HQ62NJ02□	62nH ±5%	300MHz	12	300MHz	100mA	5.0Ω	1100MHz
LQP03HQ68NH02□	68nH ±3%	300MHz	12	300MHz	100mA	5.0Ω	1100MHz
LQP03HQ68NJ02□	68nH ±5%	300MHz	12	300MHz	100mA	5.0Ω	1100MHz
LQP03HQ75NH02□	75nH ±3%	300MHz	10	300MHz	100mA	5.0Ω	1100MHz
LQP03HQ75NJ02□	75nH ±5%	300MHz	10	300MHz	100mA	5.0Ω	1100MHz
LQP03HQ82NH02□	82nH ±3%	300MHz	10	300MHz	100mA	5.0Ω	1000MHz
LQP03HQ82NJ02□	82nH ±5%	300MHz	10	300MHz	100mA	5.0Ω	1000MHz
LQP03HQ91NH02□	91nH ±3%	300MHz	10	300MHz	80mA	7.0Ω	1000MHz
LQP03HQ91NJ02□	91nH ±5%	300MHz	10	300MHz	80mA	7.0Ω	1000MHz
LQP03HQR10H02□	100nH ±3%	300MHz	10	300MHz	80mA	7.0Ω	900MHz
LQP03HQR10J02□	100nH ±5%	300MHz	10	300MHz	80mA	7.0Ω	900MHz
LQP03HQR11H02□	110nH ±3%	300MHz	10	300MHz	80mA	8.0Ω	900MHz
LQP03HQR11J02□	110nH ±5%	300MHz	10	300MHz	80mA	8.0Ω	900MHz
LQP03HQR12H02□	120nH ±3%	300MHz	10	300MHz	80mA	8.0Ω	800MHz
LQP03HQR12J02□	120nH ±5%	300MHz	10	300MHz	80mA	8.0Ω	800MHz
LQP03HQR13H02□	130nH ±3%	100MHz	7	100MHz	80mA	8.0Ω	700MHz
LQP03HQR13J02□	130nH ±5%	100MHz	7	100MHz	80mA	8.0Ω	700MHz
LQP03HQR15H02□	150nH ±3%	100MHz	7	100MHz	80mA	8.0Ω	700MHz
LQP03HQR15J02□	150nH ±5%	100MHz	7	100MHz	80mA	8.0Ω	700MHz

Operating temp. range: -55 to 125°C
 Only for reflow soldering
 *S.R.F.: Self Resonant Frequency

Inductance-Frequency Characteristics (Typ.)



Q-Frequency Characteristics (Typ.)

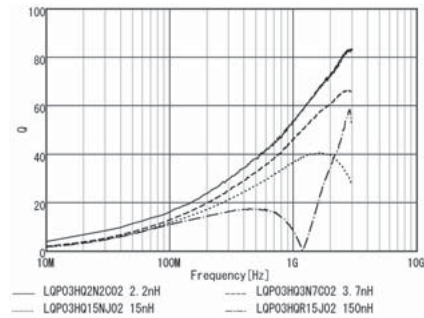

LQP03PN_02 Series 0201 (0603) inch (mm)



Packaging Code	Packaging	Minimum Quantity
D	ø180mm Paper Taping	15000
J	ø330mm Paper Taping	50000
B	Packing in Bulk	500

Part Number (□: packaging code)	Inductance	Inductance Test Frequency	Q (min.)	Q Test Frequency	Rated Current	Max. of DC Resistance	S.R.F.* (min.)
LQP03PN2N2C02□	2.2nH ±0.2nH	500MHz	10	500MHz	1400mA(Ambient temp.85°C) 1000mA(Ambient temp.125°C)	0.055Ω	9000MHz
LQP03PN2N7C02□	2.7nH ±0.2nH	500MHz	10	500MHz	1300mA(Ambient temp.85°C) 900mA(Ambient temp.125°C)	0.065Ω	6600MHz
LQP03PN3N3C02□	3.3nH ±0.2nH	500MHz	10	500MHz	1200mA(Ambient temp.85°C) 800mA(Ambient temp.125°C)	0.080Ω	5500MHz
LQP03PN3N9C02□	3.9nH ±0.2nH	500MHz	10	500MHz	1000mA(Ambient temp.85°C) 700mA(Ambient temp.125°C)	0.100Ω	4900MHz
LQP03PN4N7J02□	4.7nH ±5%	500MHz	10	500MHz	900mA(Ambient temp.85°C) 600mA(Ambient temp.125°C)	0.140Ω	4400MHz

Operating temp. range: -55 to 125°C

Only for reflow soldering

*S.R.F.: Self Resonant Frequency

In operating temperatures exceeding +85°C, derating of current is necessary for the LQP03PN_02 series. Please apply the derating curve shown in the chart according to the operating temperature. Please consider "Notice (Rating)."

Inductance-Frequency Characteristics (Typ.)



Q-Frequency Characteristics (Typ.)



Notice (Rating)

In operating temperatures exceeding +85°C, derating of current is necessary for the LQP03PN_02 series. Please apply the derating curve shown in the chart according to the operating temperature.



LQP03TG_02 Series 0201 (0603) inch (mm)



Packaging Code	Packaging	Minimum Quantity
D	ø180mm Paper Taping	15000
J	ø330mm Paper Taping	50000
B	Packing in Bulk	500

Continued on the following page. ↗

Continued from the preceding page. ↘

Part Number (□: packaging code)	Inductance	Inductance Test Frequency	Q (min.)	Q Test Frequency	Rated Current	Max. of DC Resistance	S.R.F.* (min.)
LQP03TG0N1B02□	0.1nH ±0.1nH	500MHz	-	500MHz	850mA	0.07Ω	20000MHz
LQP03TG0N2B02□	0.2nH ±0.1nH	500MHz	-	500MHz	850mA	0.08Ω	20000MHz
LQP03TG0N2C02□	0.2nH ±0.2nH	500MHz	-	500MHz	850mA	0.08Ω	20000MHz
LQP03TG0N3B02□	0.3nH ±0.1nH	500MHz	-	500MHz	850mA	0.08Ω	18000MHz
LQP03TG0N3C02□	0.3nH ±0.2nH	500MHz	-	500MHz	850mA	0.08Ω	18000MHz
LQP03TG0N4B02□	0.4nH ±0.1nH	500MHz	-	500MHz	850mA	0.08Ω	18000MHz
LQP03TG0N4C02□	0.4nH ±0.2nH	500MHz	-	500MHz	850mA	0.08Ω	18000MHz
LQP03TG0N5B02□	0.5nH ±0.1nH	500MHz	11	500MHz	850mA	0.08Ω	18000MHz
LQP03TG0N5C02□	0.5nH ±0.2nH	500MHz	11	500MHz	850mA	0.08Ω	18000MHz
LQP03TG0N6B02□	0.6nH ±0.1nH	500MHz	11	500MHz	850mA	0.08Ω	18000MHz
LQP03TG0N6C02□	0.6nH ±0.2nH	500MHz	11	500MHz	850mA	0.08Ω	18000MHz
LQP03TG0N7B02□	0.7nH ±0.1nH	500MHz	12	500MHz	750mA	0.10Ω	18000MHz
LQP03TG0N7C02□	0.7nH ±0.2nH	500MHz	12	500MHz	750mA	0.10Ω	18000MHz
LQP03TG0N8B02□	0.8nH ±0.1nH	500MHz	12	500MHz	750mA	0.10Ω	18000MHz
LQP03TG0N8C02□	0.8nH ±0.2nH	500MHz	12	500MHz	750mA	0.10Ω	18000MHz
LQP03TG0N9B02□	0.9nH ±0.1nH	500MHz	12	500MHz	700mA	0.12Ω	18000MHz
LQP03TG0N9C02□	0.9nH ±0.2nH	500MHz	12	500MHz	700mA	0.12Ω	18000MHz
LQP03TG1N0B02□	1.0nH ±0.1nH	500MHz	12	500MHz	600mA	0.15Ω	17000MHz
LQP03TG1N0C02□	1.0nH ±0.2nH	500MHz	12	500MHz	600mA	0.15Ω	17000MHz
LQP03TG1N1B02□	1.1nH ±0.1nH	500MHz	12	500MHz	600mA	0.15Ω	17000MHz
LQP03TG1N1C02□	1.1nH ±0.2nH	500MHz	12	500MHz	600mA	0.15Ω	17000MHz
LQP03TG1N2B02□	1.2nH ±0.1nH	500MHz	13	500MHz	600mA	0.15Ω	15000MHz
LQP03TG1N2C02□	1.2nH ±0.2nH	500MHz	13	500MHz	600mA	0.15Ω	15000MHz
LQP03TG1N3B02□	1.3nH ±0.1nH	500MHz	13	500MHz	600mA	0.15Ω	15000MHz
LQP03TG1N3C02□	1.3nH ±0.2nH	500MHz	13	500MHz	600mA	0.15Ω	15000MHz
LQP03TG1N4B02□	1.4nH ±0.1nH	500MHz	13	500MHz	600mA	0.15Ω	14000MHz
LQP03TG1N4C02□	1.4nH ±0.2nH	500MHz	13	500MHz	600mA	0.15Ω	14000MHz
LQP03TG1N5B02□	1.5nH ±0.1nH	500MHz	13	500MHz	600mA	0.15Ω	13500MHz
LQP03TG1N5C02□	1.5nH ±0.2nH	500MHz	13	500MHz	600mA	0.15Ω	13500MHz
LQP03TG1N6B02□	1.6nH ±0.1nH	500MHz	13	500MHz	600mA	0.15Ω	13000MHz
LQP03TG1N6C02□	1.6nH ±0.2nH	500MHz	13	500MHz	600mA	0.15Ω	13000MHz
LQP03TG1N7B02□	1.7nH ±0.1nH	500MHz	13	500MHz	500mA	0.20Ω	12500MHz
LQP03TG1N7C02□	1.7nH ±0.2nH	500MHz	13	500MHz	500mA	0.20Ω	12500MHz
LQP03TG1N8B02□	1.8nH ±0.1nH	500MHz	13	500MHz	500mA	0.20Ω	12500MHz
LQP03TG1N8C02□	1.8nH ±0.2nH	500MHz	13	500MHz	500mA	0.20Ω	12500MHz
LQP03TG1N9B02□	1.9nH ±0.1nH	500MHz	13	500MHz	450mA	0.25Ω	12500MHz
LQP03TG1N9C02□	1.9nH ±0.2nH	500MHz	13	500MHz	450mA	0.25Ω	12500MHz
LQP03TG2N0B02□	2.0nH ±0.1nH	500MHz	13	500MHz	450mA	0.25Ω	12500MHz
LQP03TG2N0C02□	2.0nH ±0.2nH	500MHz	13	500MHz	450mA	0.25Ω	12500MHz
LQP03TG2N1B02□	2.1nH ±0.1nH	500MHz	13	500MHz	450mA	0.25Ω	12000MHz
LQP03TG2N1C02□	2.1nH ±0.2nH	500MHz	13	500MHz	450mA	0.25Ω	12000MHz
LQP03TG2N2B02□	2.2nH ±0.1nH	500MHz	13	500MHz	450mA	0.25Ω	12000MHz
LQP03TG2N2C02□	2.2nH ±0.2nH	500MHz	13	500MHz	450mA	0.25Ω	12000MHz
LQP03TG2N3B02□	2.3nH ±0.1nH	500MHz	13	500MHz	450mA	0.25Ω	11500MHz
LQP03TG2N3C02□	2.3nH ±0.2nH	500MHz	13	500MHz	450mA	0.25Ω	11500MHz
LQP03TG2N4B02□	2.4nH ±0.1nH	500MHz	13	500MHz	450mA	0.25Ω	11000MHz
LQP03TG2N4C02□	2.4nH ±0.2nH	500MHz	13	500MHz	450mA	0.25Ω	11000MHz
LQP03TG2N5B02□	2.5nH ±0.1nH	500MHz	13	500MHz	450mA	0.25Ω	11000MHz
LQP03TG2N5C02□	2.5nH ±0.2nH	500MHz	13	500MHz	450mA	0.25Ω	11000MHz
LQP03TG2N6B02□	2.6nH ±0.1nH	500MHz	13	500MHz	450mA	0.25Ω	11000MHz
LQP03TG2N6C02□	2.6nH ±0.2nH	500MHz	13	500MHz	450mA	0.25Ω	11000MHz
LQP03TG2N7B02□	2.7nH ±0.1nH	500MHz	13	500MHz	450mA	0.25Ω	11000MHz
LQP03TG2N7C02□	2.7nH ±0.2nH	500MHz	13	500MHz	450mA	0.25Ω	11000MHz

Operating temp. range: -55 to 125°C
 Only for reflow soldering
 *S.R.F.: Self Resonant Frequency

Continued on the following page. ↗

Inductors for Power Lines

Inductors for General Circuits

RF Inductors
 LQP03TG_02

Continued from the preceding page. ↘

Part Number (□: packaging code)	Inductance	Inductance Test Frequency	Q (min.)	Q Test Frequency	Rated Current	Max. of DC Resistance	S.R.F.* (min.)
LQP03TG2N8B02□	2.8nH ±0.1nH	500MHz	13	500MHz	450mA	0.25Ω	9500MHz
LQP03TG2N8C02□	2.8nH ±0.2nH	500MHz	13	500MHz	450mA	0.25Ω	9500MHz
LQP03TG2N9B02□	2.9nH ±0.1nH	500MHz	13	500MHz	450mA	0.25Ω	9500MHz
LQP03TG2N9C02□	2.9nH ±0.2nH	500MHz	13	500MHz	450mA	0.25Ω	9500MHz
LQP03TG3N0B02□	3.0nH ±0.1nH	500MHz	13	500MHz	450mA	0.25Ω	9500MHz
LQP03TG3N0C02□	3.0nH ±0.2nH	500MHz	13	500MHz	450mA	0.25Ω	9500MHz
LQP03TG3N1B02□	3.1nH ±0.1nH	500MHz	13	500MHz	400mA	0.32Ω	9500MHz
LQP03TG3N1C02□	3.1nH ±0.2nH	500MHz	13	500MHz	400mA	0.32Ω	9500MHz
LQP03TG3N2B02□	3.2nH ±0.1nH	500MHz	13	500MHz	400mA	0.32Ω	9500MHz
LQP03TG3N2C02□	3.2nH ±0.2nH	500MHz	13	500MHz	400mA	0.32Ω	9500MHz
LQP03TG3N3B02□	3.3nH ±0.1nH	500MHz	13	500MHz	400mA	0.32Ω	9500MHz
LQP03TG3N3C02□	3.3nH ±0.2nH	500MHz	13	500MHz	400mA	0.32Ω	9500MHz
LQP03TG3N4B02□	3.4nH ±0.1nH	500MHz	13	500MHz	350mA	0.35Ω	8000MHz
LQP03TG3N4C02□	3.4nH ±0.2nH	500MHz	13	500MHz	350mA	0.35Ω	8000MHz
LQP03TG3N5B02□	3.5nH ±0.1nH	500MHz	13	500MHz	350mA	0.35Ω	8000MHz
LQP03TG3N5C02□	3.5nH ±0.2nH	500MHz	13	500MHz	350mA	0.35Ω	8000MHz
LQP03TG3N6B02□	3.6nH ±0.1nH	500MHz	13	500MHz	350mA	0.35Ω	8000MHz
LQP03TG3N6C02□	3.6nH ±0.2nH	500MHz	13	500MHz	350mA	0.35Ω	8000MHz
LQP03TG3N7B02□	3.7nH ±0.1nH	500MHz	13	500MHz	350mA	0.35Ω	7000MHz
LQP03TG3N7C02□	3.7nH ±0.2nH	500MHz	13	500MHz	350mA	0.35Ω	7000MHz
LQP03TG3N8B02□	3.8nH ±0.1nH	500MHz	13	500MHz	350mA	0.35Ω	7000MHz
LQP03TG3N8C02□	3.8nH ±0.2nH	500MHz	13	500MHz	350mA	0.35Ω	7000MHz
LQP03TG3N9B02□	3.9nH ±0.1nH	500MHz	13	500MHz	350mA	0.35Ω	6500MHz
LQP03TG3N9C02□	3.9nH ±0.2nH	500MHz	13	500MHz	350mA	0.35Ω	6500MHz
LQP03TG4N3H02□	4.3nH ±3%	500MHz	13	500MHz	300mA	0.58Ω	6500MHz
LQP03TG4N3J02□	4.3nH ±5%	500MHz	13	500MHz	300mA	0.58Ω	6500MHz
LQP03TG4N7H02□	4.7nH ±3%	500MHz	12	500MHz	250mA	0.72Ω	6500MHz
LQP03TG4N7J02□	4.7nH ±5%	500MHz	12	500MHz	250mA	0.72Ω	6500MHz
LQP03TG5N1H02□	5.1nH ±3%	500MHz	12	500MHz	250mA	0.72Ω	6500MHz
LQP03TG5N1J02□	5.1nH ±5%	500MHz	12	500MHz	250mA	0.72Ω	6500MHz
LQP03TG5N6H02□	5.6nH ±3%	500MHz	12	500MHz	250mA	0.88Ω	6000MHz
LQP03TG5N6J02□	5.6nH ±5%	500MHz	12	500MHz	250mA	0.88Ω	6000MHz
LQP03TG6N2H02□	6.2nH ±3%	500MHz	12	500MHz	200mA	1.15Ω	6000MHz
LQP03TG6N2J02□	6.2nH ±5%	500MHz	12	500MHz	200mA	1.15Ω	6000MHz
LQP03TG6N8H02□	6.8nH ±3%	500MHz	12	500MHz	200mA	1.15Ω	5400MHz
LQP03TG6N8J02□	6.8nH ±5%	500MHz	12	500MHz	200mA	1.15Ω	5400MHz
LQP03TG7N5H02□	7.5nH ±3%	500MHz	12	500MHz	200mA	1.22Ω	4800MHz
LQP03TG7N5J02□	7.5nH ±5%	500MHz	12	500MHz	200mA	1.22Ω	4800MHz
LQP03TG8N2H02□	8.2nH ±3%	500MHz	12	500MHz	200mA	1.40Ω	4800MHz
LQP03TG8N2J02□	8.2nH ±5%	500MHz	12	500MHz	200mA	1.40Ω	4800MHz
LQP03TG9N1H02□	9.1nH ±3%	500MHz	11	500MHz	200mA	1.40Ω	4500MHz
LQP03TG9N1J02□	9.1nH ±5%	500MHz	11	500MHz	200mA	1.40Ω	4500MHz
LQP03TG10NH02□	10nH ±3%	500MHz	11	500MHz	190mA	1.52Ω	4500MHz
LQP03TG10NJ02□	10nH ±5%	500MHz	11	500MHz	190mA	1.52Ω	4500MHz
LQP03TG11NH02□	11nH ±3%	500MHz	11	500MHz	180mA	1.65Ω	4100MHz
LQP03TG11NJ02□	11nH ±5%	500MHz	11	500MHz	180mA	1.65Ω	4100MHz
LQP03TG12NH02□	12nH ±3%	500MHz	11	500MHz	180mA	1.78Ω	3700MHz
LQP03TG12NJ02□	12nH ±5%	500MHz	11	500MHz	180mA	1.78Ω	3700MHz
LQP03TG13NH02□	13nH ±3%	500MHz	11	500MHz	170mA	1.82Ω	3400MHz
LQP03TG13NJ02□	13nH ±5%	500MHz	11	500MHz	170mA	1.82Ω	3400MHz
LQP03TG15NH02□	15nH ±3%	500MHz	11	500MHz	170mA	1.90Ω	3100MHz
LQP03TG15NJ02□	15nH ±5%	500MHz	11	500MHz	170mA	1.90Ω	3100MHz
LQP03TG16NH02□	16nH ±3%	500MHz	11	500MHz	160mA	2.03Ω	2900MHz

Operating temp. range: -55 to 125°C
 Only for reflow soldering
 *S.R.F.: Self Resonant Frequency

Continued on the following page. ↗

Continued from the preceding page. ↘

Part Number (□: packaging code)	Inductance	Inductance Test Frequency	Q (min.)	Q Test Frequency	Rated Current	Max. of DC Resistance	S.R.F.* (min.)
LQP03TG16NJ02□	16nH ±5%	500MHz	11	500MHz	160mA	2.03Ω	2900MHz
LQP03TG18NH02□	18nH ±3%	500MHz	11	500MHz	160mA	2.28Ω	2800MHz
LQP03TG18NJ02□	18nH ±5%	500MHz	11	500MHz	160mA	2.28Ω	2800MHz
LQP03TG20NH02□	20nH ±3%	500MHz	9	500MHz	140mA	2.57Ω	2600MHz
LQP03TG20NJ02□	20nH ±5%	500MHz	9	500MHz	140mA	2.57Ω	2600MHz
LQP03TG22NH02□	22nH ±3%	500MHz	9	500MHz	140mA	2.85Ω	2500MHz
LQP03TG22NJ02□	22nH ±5%	500MHz	9	500MHz	140mA	2.85Ω	2500MHz
LQP03TG24NH02□	24nH ±3%	500MHz	7	500MHz	120mA	3.17Ω	2000MHz
LQP03TG24NJ02□	24nH ±5%	500MHz	7	500MHz	120mA	3.17Ω	2000MHz
LQP03TG27NH02□	27nH ±3%	500MHz	7	500MHz	120mA	3.65Ω	1700MHz
LQP03TG27NJ02□	27nH ±5%	500MHz	7	500MHz	120mA	3.65Ω	1700MHz
LQP03TG33NJ02□	33nH ±5%	300MHz	7	300MHz	110mA	4.25Ω	1600MHz
LQP03TG39NJ02□	39nH ±5%	300MHz	7	300MHz	110mA	4.6Ω	1500MHz
LQP03TG47NJ02□	47nH ±5%	300MHz	7	300MHz	100mA	5.2Ω	1300MHz
LQP03TG56NJ02□	56nH ±5%	300MHz	7	300MHz	100mA	5.6Ω	1200MHz
LQP03TG68NJ02□	68nH ±5%	300MHz	6	300MHz	90mA	6.25Ω	1100MHz
LQP03TG82NJ02□	82nH ±5%	300MHz	6	300MHz	90mA	7.15Ω	1000MHz
LQP03TGR10J02□	100nH ±5%	300MHz	6	300MHz	80mA	8.05Ω	900MHz
LQP03TGR12J02□	120nH ±5%	300MHz	6	300MHz	80mA	8.75Ω	800MHz

Operating temp. range: -55 to 125°C

Only for reflow soldering

*S.R.F.: Self Resonant Frequency

Inductance-Frequency Characteristics (Typ.)



— LQP03TG2N2002 2.2nH — LQP03TG4N3J02 4.3nH
 — LQP03TG16NJ02 16nH — LQP03TGR12J02 120nH

Q-Frequency Characteristics (Typ.)



— LQP03TG2N2002 2.2nH — LQP03TG4N3J02 4.3nH
 — LQP03TG16NJ02 16nH — LQP03TGR12J02 120nH

LQP03TN_02 Series 0201 (0603) inch (mm)



(in mm)

Packaging Code	Packaging	Minimum Quantity
D	ø180mm Paper Taping	15000
J	ø330mm Paper Taping	50000
B	Packing in Bulk	500

Continued on the following page. ↗

Continued from the preceding page. ↘

Part Number (□: packaging code)	Inductance	Inductance Test Frequency	Q (min.)	Q Test Frequency	Rated Current	Max. of DC Resistance	S.R.F.* (min.)
LQP03TN0N6B02□	0.6nH ±0.1nH	500MHz	14	500MHz	850mA	0.07Ω	20000MHz
LQP03TN0N6C02□	0.6nH ±0.2nH	500MHz	14	500MHz	850mA	0.07Ω	20000MHz
LQP03TN0N7B02□	0.7nH ±0.1nH	500MHz	14	500MHz	800mA	0.08Ω	20000MHz
LQP03TN0N7C02□	0.7nH ±0.2nH	500MHz	14	500MHz	800mA	0.08Ω	20000MHz
LQP03TN0N8B02□	0.8nH ±0.1nH	500MHz	14	500MHz	800mA	0.08Ω	18000MHz
LQP03TN0N8C02□	0.8nH ±0.2nH	500MHz	14	500MHz	800mA	0.08Ω	18000MHz
LQP03TN0N9B02□	0.9nH ±0.1nH	500MHz	14	500MHz	750mA	0.10Ω	18000MHz
LQP03TN0N9C02□	0.9nH ±0.2nH	500MHz	14	500MHz	750mA	0.10Ω	18000MHz
LQP03TN1N0B02□	1.0nH ±0.1nH	500MHz	14	500MHz	750mA	0.10Ω	17000MHz
LQP03TN1N0C02□	1.0nH ±0.2nH	500MHz	14	500MHz	750mA	0.10Ω	17000MHz
LQP03TN1N1B02□	1.1nH ±0.1nH	500MHz	14	500MHz	750mA	0.10Ω	17000MHz
LQP03TN1N1C02□	1.1nH ±0.2nH	500MHz	14	500MHz	750mA	0.10Ω	17000MHz
LQP03TN1N2B02□	1.2nH ±0.1nH	500MHz	14	500MHz	750mA	0.10Ω	17000MHz
LQP03TN1N2C02□	1.2nH ±0.2nH	500MHz	14	500MHz	750mA	0.10Ω	17000MHz
LQP03TN1N3B02□	1.3nH ±0.1nH	500MHz	14	500MHz	600mA	0.15Ω	17000MHz
LQP03TN1N3C02□	1.3nH ±0.2nH	500MHz	14	500MHz	600mA	0.15Ω	17000MHz
LQP03TN1N4B02□	1.4nH ±0.1nH	500MHz	14	500MHz	600mA	0.15Ω	16000MHz
LQP03TN1N4C02□	1.4nH ±0.2nH	500MHz	14	500MHz	600mA	0.15Ω	16000MHz
LQP03TN1N5B02□	1.5nH ±0.1nH	500MHz	14	500MHz	600mA	0.15Ω	15000MHz
LQP03TN1N5C02□	1.5nH ±0.2nH	500MHz	14	500MHz	600mA	0.15Ω	15000MHz
LQP03TN1N6B02□	1.6nH ±0.1nH	500MHz	14	500MHz	600mA	0.15Ω	15000MHz
LQP03TN1N6C02□	1.6nH ±0.2nH	500MHz	14	500MHz	600mA	0.15Ω	15000MHz
LQP03TN1N7B02□	1.7nH ±0.1nH	500MHz	14	500MHz	600mA	0.15Ω	15000MHz
LQP03TN1N7C02□	1.7nH ±0.2nH	500MHz	14	500MHz	600mA	0.15Ω	15000MHz
LQP03TN1N8B02□	1.8nH ±0.1nH	500MHz	14	500MHz	600mA	0.15Ω	15000MHz
LQP03TN1N8C02□	1.8nH ±0.2nH	500MHz	14	500MHz	600mA	0.15Ω	15000MHz
LQP03TN1N9B02□	1.9nH ±0.1nH	500MHz	14	500MHz	600mA	0.15Ω	12500MHz
LQP03TN1N9C02□	1.9nH ±0.2nH	500MHz	14	500MHz	600mA	0.15Ω	12500MHz
LQP03TN2N0B02□	2.0nH ±0.1nH	500MHz	14	500MHz	600mA	0.15Ω	12500MHz
LQP03TN2N0C02□	2.0nH ±0.2nH	500MHz	14	500MHz	600mA	0.15Ω	12500MHz
LQP03TN2N1B02□	2.1nH ±0.1nH	500MHz	14	500MHz	600mA	0.15Ω	11000MHz
LQP03TN2N1C02□	2.1nH ±0.2nH	500MHz	14	500MHz	600mA	0.15Ω	11000MHz
LQP03TN2N2B02□	2.2nH ±0.1nH	500MHz	14	500MHz	600mA	0.15Ω	11000MHz
LQP03TN2N2C02□	2.2nH ±0.2nH	500MHz	14	500MHz	600mA	0.15Ω	11000MHz
LQP03TN2N3B02□	2.3nH ±0.1nH	500MHz	14	500MHz	500mA	0.20Ω	10000MHz
LQP03TN2N3C02□	2.3nH ±0.2nH	500MHz	14	500MHz	500mA	0.20Ω	10000MHz
LQP03TN2N4B02□	2.4nH ±0.1nH	500MHz	14	500MHz	500mA	0.20Ω	10000MHz
LQP03TN2N4C02□	2.4nH ±0.2nH	500MHz	14	500MHz	500mA	0.20Ω	10000MHz
LQP03TN2N5B02□	2.5nH ±0.1nH	500MHz	14	500MHz	500mA	0.20Ω	10000MHz
LQP03TN2N5C02□	2.5nH ±0.2nH	500MHz	14	500MHz	500mA	0.20Ω	10000MHz
LQP03TN2N6B02□	2.6nH ±0.1nH	500MHz	14	500MHz	500mA	0.20Ω	10000MHz
LQP03TN2N6C02□	2.6nH ±0.2nH	500MHz	14	500MHz	500mA	0.20Ω	10000MHz
LQP03TN2N7B02□	2.7nH ±0.1nH	500MHz	14	500MHz	500mA	0.20Ω	10000MHz
LQP03TN2N7C02□	2.7nH ±0.2nH	500MHz	14	500MHz	500mA	0.20Ω	10000MHz
LQP03TN2N8B02□	2.8nH ±0.1nH	500MHz	14	500MHz	500mA	0.20Ω	9500MHz
LQP03TN2N8C02□	2.8nH ±0.2nH	500MHz	14	500MHz	500mA	0.20Ω	9500MHz
LQP03TN2N9B02□	2.9nH ±0.1nH	500MHz	14	500MHz	500mA	0.20Ω	9500MHz
LQP03TN2N9C02□	2.9nH ±0.2nH	500MHz	14	500MHz	500mA	0.20Ω	9500MHz
LQP03TN3N0B02□	3.0nH ±0.1nH	500MHz	14	500MHz	450mA	0.25Ω	9500MHz
LQP03TN3N0C02□	3.0nH ±0.2nH	500MHz	14	500MHz	450mA	0.25Ω	9500MHz
LQP03TN3N1B02□	3.1nH ±0.1nH	500MHz	14	500MHz	450mA	0.25Ω	8000MHz
LQP03TN3N1C02□	3.1nH ±0.2nH	500MHz	14	500MHz	450mA	0.25Ω	8000MHz
LQP03TN3N2B02□	3.2nH ±0.1nH	500MHz	14	500MHz	450mA	0.25Ω	8000MHz

Operating temp. range: -55 to 125°C
 Only for reflow soldering
 *S.R.F.: Self Resonant Frequency

Continued on the following page. ↗

Continued from the preceding page. ↘

Part Number (□: packaging code)	Inductance	Inductance Test Frequency	Q (min.)	Q Test Frequency	Rated Current	Max. of DC Resistance	S.R.F.* (min.)
LQP03TN3N2C02□	3.2nH ±0.2nH	500MHz	14	500MHz	450mA	0.25Ω	8000MHz
LQP03TN3N3B02□	3.3nH ±0.1nH	500MHz	14	500MHz	450mA	0.25Ω	8000MHz
LQP03TN3N3C02□	3.3nH ±0.2nH	500MHz	14	500MHz	450mA	0.25Ω	8000MHz
LQP03TN3N4B02□	3.4nH ±0.1nH	500MHz	14	500MHz	450mA	0.25Ω	7000MHz
LQP03TN3N4C02□	3.4nH ±0.2nH	500MHz	14	500MHz	450mA	0.25Ω	7000MHz
LQP03TN3N5B02□	3.5nH ±0.1nH	500MHz	14	500MHz	450mA	0.25Ω	7000MHz
LQP03TN3N5C02□	3.5nH ±0.2nH	500MHz	14	500MHz	450mA	0.25Ω	7000MHz
LQP03TN3N6B02□	3.6nH ±0.1nH	500MHz	14	500MHz	400mA	0.30Ω	6000MHz
LQP03TN3N6C02□	3.6nH ±0.2nH	500MHz	14	500MHz	400mA	0.30Ω	6000MHz
LQP03TN3N7B02□	3.7nH ±0.1nH	500MHz	14	500MHz	400mA	0.30Ω	6000MHz
LQP03TN3N7C02□	3.7nH ±0.2nH	500MHz	14	500MHz	400mA	0.30Ω	6000MHz
LQP03TN3N8B02□	3.8nH ±0.1nH	500MHz	14	500MHz	400mA	0.30Ω	6000MHz
LQP03TN3N8C02□	3.8nH ±0.2nH	500MHz	14	500MHz	400mA	0.30Ω	6000MHz
LQP03TN3N9B02□	3.9nH ±0.1nH	500MHz	14	500MHz	400mA	0.30Ω	5700MHz
LQP03TN3N9C02□	3.9nH ±0.2nH	500MHz	14	500MHz	400mA	0.30Ω	5700MHz
LQP03TN4N0B02□	4.0nH ±0.1nH	500MHz	14	500MHz	350mA	0.40Ω	5300MHz
LQP03TN4N0C02□	4.0nH ±0.2nH	500MHz	14	500MHz	350mA	0.40Ω	5300MHz
LQP03TN4N1B02□	4.1nH ±0.1nH	500MHz	14	500MHz	350mA	0.40Ω	5300MHz
LQP03TN4N1C02□	4.1nH ±0.2nH	500MHz	14	500MHz	350mA	0.40Ω	5300MHz
LQP03TN4N2B02□	4.2nH ±0.1nH	500MHz	14	500MHz	350mA	0.40Ω	5300MHz
LQP03TN4N2C02□	4.2nH ±0.2nH	500MHz	14	500MHz	350mA	0.40Ω	5300MHz
LQP03TN4N3H02□	4.3nH ±3%	500MHz	14	500MHz	350mA	0.40Ω	5300MHz
LQP03TN4N3J02□	4.3nH ±5%	500MHz	14	500MHz	350mA	0.40Ω	5300MHz
LQP03TN4N7H02□	4.7nH ±3%	500MHz	14	500MHz	350mA	0.40Ω	4400MHz
LQP03TN4N7J02□	4.7nH ±5%	500MHz	14	500MHz	350mA	0.40Ω	4400MHz
LQP03TN5N1H02□	5.1nH ±3%	500MHz	14	500MHz	350mA	0.40Ω	4200MHz
LQP03TN5N1J02□	5.1nH ±5%	500MHz	14	500MHz	350mA	0.40Ω	4200MHz
LQP03TN5N6H02□	5.6nH ±3%	500MHz	14	500MHz	350mA	0.40Ω	4000MHz
LQP03TN5N6J02□	5.6nH ±5%	500MHz	14	500MHz	350mA	0.40Ω	4000MHz
LQP03TN6N2H02□	6.2nH ±3%	500MHz	14	500MHz	300mA	0.60Ω	4000MHz
LQP03TN6N2J02□	6.2nH ±5%	500MHz	14	500MHz	300mA	0.60Ω	4000MHz
LQP03TN6N8H02□	6.8nH ±3%	500MHz	14	500MHz	300mA	0.60Ω	3900MHz
LQP03TN6N8J02□	6.8nH ±5%	500MHz	14	500MHz	300mA	0.60Ω	3900MHz
LQP03TN7N5H02□	7.5nH ±3%	500MHz	14	500MHz	300mA	0.60Ω	3700MHz
LQP03TN7N5J02□	7.5nH ±5%	500MHz	14	500MHz	300mA	0.60Ω	3700MHz
LQP03TN8N2H02□	8.2nH ±3%	500MHz	14	500MHz	250mA	0.70Ω	3600MHz
LQP03TN8N2J02□	8.2nH ±5%	500MHz	14	500MHz	250mA	0.70Ω	3600MHz
LQP03TN9N1H02□	9.1nH ±3%	500MHz	14	500MHz	250mA	0.70Ω	3300MHz
LQP03TN9N1J02□	9.1nH ±5%	500MHz	14	500MHz	250mA	0.70Ω	3300MHz
LQP03TN10NH02□	10nH ±3%	500MHz	14	500MHz	250mA	0.70Ω	3200MHz
LQP03TN10NJ02□	10nH ±5%	500MHz	14	500MHz	250mA	0.70Ω	3200MHz
LQP03TN11NH02□	11nH ±3%	500MHz	14	500MHz	250mA	0.80Ω	2900MHz
LQP03TN11NJ02□	11nH ±5%	500MHz	14	500MHz	250mA	0.80Ω	2900MHz
LQP03TN12NH02□	12nH ±3%	500MHz	12	500MHz	250mA	0.70Ω	2900MHz
LQP03TN12NJ02□	12nH ±5%	500MHz	12	500MHz	250mA	0.70Ω	2900MHz
LQP03TN13NH02□	13nH ±3%	500MHz	12	500MHz	250mA	0.80Ω	2600MHz
LQP03TN13NJ02□	13nH ±5%	500MHz	12	500MHz	250mA	0.80Ω	2600MHz
LQP03TN15NH02□	15nH ±3%	500MHz	12	500MHz	250mA	0.70Ω	2600MHz
LQP03TN15NJ02□	15nH ±5%	500MHz	12	500MHz	250mA	0.70Ω	2600MHz
LQP03TN16NH02□	16nH ±3%	500MHz	12	500MHz	200mA	0.95Ω	2200MHz
LQP03TN16NJ02□	16nH ±5%	500MHz	12	500MHz	200mA	0.95Ω	2200MHz
LQP03TN18NH02□	18nH ±3%	500MHz	12	500MHz	200mA	0.80Ω	2200MHz
LQP03TN18NJ02□	18nH ±5%	500MHz	12	500MHz	200mA	0.80Ω	2200MHz

Operating temp. range: -55 to 125°C
 Only for reflow soldering
 *S.R.F.: Self Resonant Frequency

Continued on the following page. ↗

Continued from the preceding page. ↘

Part Number (□: packaging code)	Inductance	Inductance Test Frequency	Q (min.)	Q Test Frequency	Rated Current	Max. of DC Resistance	S.R.F.* (min.)
LQP03TN20NH02□	20nH ±3%	500MHz	12	500MHz	150mA	2.30Ω	2200MHz
LQP03TN20NJ02□	20nH ±5%	500MHz	12	500MHz	150mA	2.30Ω	2200MHz
LQP03TN22NH02□	22nH ±3%	500MHz	12	500MHz	150mA	1.90Ω	2200MHz
LQP03TN22NJ02□	22nH ±5%	500MHz	12	500MHz	150mA	1.90Ω	2200MHz
LQP03TN24NH02□	24nH ±3%	500MHz	12	500MHz	140mA	2.30Ω	2000MHz
LQP03TN24NJ02□	24nH ±5%	500MHz	12	500MHz	140mA	2.30Ω	2000MHz
LQP03TN27NH02□	27nH ±3%	500MHz	12	500MHz	140mA	2.30Ω	2000MHz
LQP03TN27NJ02□	27nH ±5%	500MHz	12	500MHz	140mA	2.30Ω	2000MHz
LQP03TN30NH02□	30nH ±3%	500MHz	9	500MHz	120mA	2.95Ω	1700MHz
LQP03TN30NJ02□	30nH ±5%	500MHz	9	500MHz	120mA	2.95Ω	1700MHz
LQP03TN33NH02□	33nH ±3%	300MHz	9	300MHz	120mA	2.95Ω	1700MHz
LQP03TN33NJ02□	33nH ±5%	300MHz	9	300MHz	120mA	2.95Ω	1700MHz
LQP03TN36NH02□	36nH ±3%	300MHz	9	300MHz	120mA	3.00Ω	1500MHz
LQP03TN36NJ02□	36nH ±5%	300MHz	9	300MHz	120mA	3.00Ω	1500MHz
LQP03TN39NH02□	39nH ±3%	300MHz	9	300MHz	120mA	3.00Ω	1500MHz
LQP03TN39NJ02□	39nH ±5%	300MHz	9	300MHz	120mA	3.00Ω	1500MHz
LQP03TN43NH02□	43nH ±3%	300MHz	9	300MHz	100mA	3.60Ω	1300MHz
LQP03TN43NJ02□	43nH ±5%	300MHz	9	300MHz	100mA	3.60Ω	1300MHz
LQP03TN47NH02□	47nH ±3%	300MHz	9	300MHz	100mA	3.60Ω	1300MHz
LQP03TN47NJ02□	47nH ±5%	300MHz	9	300MHz	100mA	3.60Ω	1300MHz
LQP03TN51NH02□	51nH ±3%	300MHz	9	300MHz	100mA	3.90Ω	1200MHz
LQP03TN51NJ02□	51nH ±5%	300MHz	9	300MHz	100mA	3.90Ω	1200MHz
LQP03TN56NH02□	56nH ±3%	300MHz	9	300MHz	100mA	3.90Ω	1200MHz
LQP03TN56NJ02□	56nH ±5%	300MHz	9	300MHz	100mA	3.90Ω	1200MHz
LQP03TN62NH02□	62nH ±3%	300MHz	8	300MHz	100mA	8Ω	1100MHz
LQP03TN62NJ02□	62nH ±5%	300MHz	8	300MHz	100mA	8Ω	1100MHz
LQP03TN68NH02□	68nH ±3%	300MHz	8	300MHz	100mA	8Ω	1100MHz
LQP03TN68NJ02□	68nH ±5%	300MHz	8	300MHz	100mA	8Ω	1100MHz
LQP03TN75NH02□	75nH ±3%	300MHz	8	300MHz	100mA	10Ω	1000MHz
LQP03TN75NJ02□	75nH ±5%	300MHz	8	300MHz	100mA	10Ω	1000MHz
LQP03TN82NH02□	82nH ±3%	300MHz	8	300MHz	100mA	10Ω	1000MHz
LQP03TN82NJ02□	82nH ±5%	300MHz	8	300MHz	100mA	10Ω	1000MHz
LQP03TN91NH02□	91nH ±3%	300MHz	8	300MHz	80mA	10Ω	900MHz
LQP03TN91NJ02□	91nH ±5%	300MHz	8	300MHz	80mA	10Ω	900MHz
LQP03TNR10H02□	100nH ±3%	300MHz	8	300MHz	80mA	10Ω	900MHz
LQP03TNR10J02□	100nH ±5%	300MHz	8	300MHz	80mA	10Ω	900MHz
LQP03TNR11H02□	110nH ±3%	300MHz	8	300MHz	80mA	12Ω	800MHz
LQP03TNR11J02□	110nH ±5%	300MHz	8	300MHz	80mA	12Ω	800MHz
LQP03TNR12H02□	120nH ±3%	300MHz	8	300MHz	80mA	12Ω	800MHz
LQP03TNR12J02□	120nH ±5%	300MHz	8	300MHz	80mA	12Ω	800MHz
LQP03TNR13H02□	130nH ±3%	100MHz	5	100MHz	80mA	9Ω	650MHz
LQP03TNR13J02□	130nH ±5%	100MHz	5	100MHz	80mA	9Ω	650MHz
LQP03TNR15H02□	150nH ±3%	100MHz	5	100MHz	80mA	9Ω	650MHz
LQP03TNR15J02□	150nH ±5%	100MHz	5	100MHz	80mA	9Ω	650MHz
LQP03TNR16H02□	160nH ±3%	100MHz	5	100MHz	70mA	11Ω	600MHz
LQP03TNR16J02□	160nH ±5%	100MHz	5	100MHz	70mA	11Ω	600MHz
LQP03TNR18H02□	180nH ±3%	100MHz	5	100MHz	70mA	11Ω	600MHz
LQP03TNR18J02□	180nH ±5%	100MHz	5	100MHz	70mA	11Ω	600MHz
LQP03TNR20H02□	200nH ±3%	100MHz	5	100MHz	60mA	13Ω	500MHz
LQP03TNR20J02□	200nH ±5%	100MHz	5	100MHz	60mA	13Ω	500MHz
LQP03TNR22H02□	220nH ±3%	100MHz	5	100MHz	60mA	13Ω	500MHz
LQP03TNR22J02□	220nH ±5%	100MHz	5	100MHz	60mA	13Ω	500MHz
LQP03TNR24H02□	240nH ±3%	100MHz	5	100MHz	60mA	15Ω	450MHz

Operating temp. range: -55 to 125°C
 Only for reflow soldering
 *S.R.F.: Self Resonant Frequency

Continued on the following page. ↗

Continued from the preceding page. ↘

Part Number (□: packaging code)	Inductance	Inductance Test Frequency	Q (min.)	Q Test Frequency	Rated Current	Max. of DC Resistance	S.R.F.* (min.)
LQP03TNR24J02□	240nH ±5%	100MHz	5	100MHz	60mA	15Ω	450MHz
LQP03TNR27H02□	270nH ±3%	100MHz	5	100MHz	60mA	15Ω	450MHz
LQP03TNR27J02□	270nH ±5%	100MHz	5	100MHz	60mA	15Ω	450MHz

Operating temp. range: -55 to 125°C
 Only for reflow soldering
 *S.R.F.: Self Resonant Frequency

Inductance-Frequency Characteristics (Typ.)

Q-Frequency Characteristics (Typ.)



LQP03TQ_02 Series 0201 (0603) inch (mm)

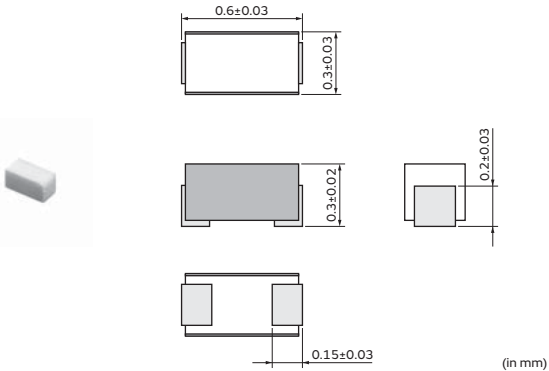

Packaging Code	Packaging	Minimum Quantity
D	ø180mm Paper Taping	15000
J	ø330mm Paper Taping	50000
B	Packing in Bulk	500

Part Number (□: packaging code)	Inductance	Inductance Test Frequency	Q (min.)	Q Test Frequency	Rated Current	Max. of DC Resistance	S.R.F.* (min.)
LQP03TQ0N6W02□	0.6nH ±0.05nH	500MHz	17	500MHz	1000mA	0.05Ω	20000MHz
LQP03TQ0N6B02□	0.6nH ±0.1nH	500MHz	17	500MHz	1000mA	0.05Ω	20000MHz
LQP03TQ0N6C02□	0.6nH ±0.2nH	500MHz	17	500MHz	1000mA	0.05Ω	20000MHz
LQP03TQ0N7W02□	0.7nH ±0.05nH	500MHz	17	500MHz	1000mA	0.05Ω	20000MHz
LQP03TQ0N7B02□	0.7nH ±0.1nH	500MHz	17	500MHz	1000mA	0.05Ω	20000MHz
LQP03TQ0N7C02□	0.7nH ±0.2nH	500MHz	17	500MHz	1000mA	0.05Ω	20000MHz
LQP03TQ0N8W02□	0.8nH ±0.05nH	500MHz	17	500MHz	1000mA	0.05Ω	18000MHz
LQP03TQ0N8B02□	0.8nH ±0.1nH	500MHz	17	500MHz	1000mA	0.05Ω	18000MHz
LQP03TQ0N8C02□	0.8nH ±0.2nH	500MHz	17	500MHz	1000mA	0.05Ω	18000MHz
LQP03TQ0N9W02□	0.9nH ±0.05nH	500MHz	17	500MHz	800mA	0.08Ω	18000MHz
LQP03TQ0N9B02□	0.9nH ±0.1nH	500MHz	17	500MHz	800mA	0.08Ω	18000MHz
LQP03TQ0N9C02□	0.9nH ±0.2nH	500MHz	17	500MHz	800mA	0.08Ω	18000MHz
LQP03TQ1N0W02□	1.0nH ±0.05nH	500MHz	17	500MHz	800mA	0.08Ω	17000MHz
LQP03TQ1N0B02□	1.0nH ±0.1nH	500MHz	17	500MHz	800mA	0.08Ω	17000MHz
LQP03TQ1N0C02□	1.0nH ±0.2nH	500MHz	17	500MHz	800mA	0.08Ω	17000MHz
LQP03TQ1N1W02□	1.1nH ±0.05nH	500MHz	17	500MHz	800mA	0.08Ω	17000MHz
LQP03TQ1N1B02□	1.1nH ±0.1nH	500MHz	17	500MHz	800mA	0.08Ω	17000MHz

Operating temp. range: -55 to 125°C
 Only for reflow soldering
 *S.R.F.: Self Resonant Frequency

Continued on the following page. ↗

Inductors for Power Lines

Inductors for General Circuits

RF Inductors
LQP03TQ_02

Continued from the preceding page. ↘

Part Number (□: packaging code)	Inductance	Inductance Test Frequency	Q (min.)	Q Test Frequency	Rated Current	Max. of DC Resistance	S.R.F.* (min.)
LQP03TQ1N1C02□	1.1nH ±0.2nH	500MHz	17	500MHz	800mA	0.08Ω	17000MHz
LQP03TQ1N2W02□	1.2nH ±0.05nH	500MHz	17	500MHz	800mA	0.08Ω	17000MHz
LQP03TQ1N2B02□	1.2nH ±0.1nH	500MHz	17	500MHz	800mA	0.08Ω	17000MHz
LQP03TQ1N2C02□	1.2nH ±0.2nH	500MHz	17	500MHz	800mA	0.08Ω	17000MHz
LQP03TQ1N3W02□	1.3nH ±0.05nH	500MHz	17	500MHz	700mA	0.1Ω	17000MHz
LQP03TQ1N3B02□	1.3nH ±0.1nH	500MHz	17	500MHz	700mA	0.1Ω	17000MHz
LQP03TQ1N3C02□	1.3nH ±0.2nH	500MHz	17	500MHz	700mA	0.1Ω	17000MHz
LQP03TQ1N4W02□	1.4nH ±0.05nH	500MHz	17	500MHz	700mA	0.1Ω	16000MHz
LQP03TQ1N4B02□	1.4nH ±0.1nH	500MHz	17	500MHz	700mA	0.1Ω	16000MHz
LQP03TQ1N4C02□	1.4nH ±0.2nH	500MHz	17	500MHz	700mA	0.1Ω	16000MHz
LQP03TQ1N5W02□	1.5nH ±0.05nH	500MHz	17	500MHz	650mA	0.1Ω	15000MHz
LQP03TQ1N5B02□	1.5nH ±0.1nH	500MHz	17	500MHz	650mA	0.1Ω	15000MHz
LQP03TQ1N5C02□	1.5nH ±0.2nH	500MHz	17	500MHz	650mA	0.1Ω	15000MHz
LQP03TQ1N6B02□	1.6nH ±0.1nH	500MHz	17	500MHz	650mA	0.1Ω	15000MHz
LQP03TQ1N6C02□	1.6nH ±0.2nH	500MHz	17	500MHz	650mA	0.1Ω	15000MHz
LQP03TQ1N7B02□	1.7nH ±0.1nH	500MHz	17	500MHz	650mA	0.1Ω	15000MHz
LQP03TQ1N7C02□	1.7nH ±0.2nH	500MHz	17	500MHz	650mA	0.1Ω	15000MHz
LQP03TQ1N8B02□	1.8nH ±0.1nH	500MHz	17	500MHz	650mA	0.1Ω	15000MHz
LQP03TQ1N8C02□	1.8nH ±0.2nH	500MHz	17	500MHz	650mA	0.1Ω	15000MHz
LQP03TQ1N9B02□	1.9nH ±0.1nH	500MHz	17	500MHz	650mA	0.1Ω	12500MHz
LQP03TQ1N9C02□	1.9nH ±0.2nH	500MHz	17	500MHz	650mA	0.1Ω	12500MHz
LQP03TQ2N0B02□	2.0nH ±0.1nH	500MHz	17	500MHz	650mA	0.1Ω	12500MHz
LQP03TQ2N0C02□	2.0nH ±0.2nH	500MHz	17	500MHz	650mA	0.1Ω	12500MHz
LQP03TQ2N1B02□	2.1nH ±0.1nH	500MHz	17	500MHz	650mA	0.12Ω	11000MHz
LQP03TQ2N1C02□	2.1nH ±0.2nH	500MHz	17	500MHz	650mA	0.12Ω	11000MHz
LQP03TQ2N2B02□	2.2nH ±0.1nH	500MHz	17	500MHz	650mA	0.12Ω	11000MHz
LQP03TQ2N2C02□	2.2nH ±0.2nH	500MHz	17	500MHz	650mA	0.12Ω	11000MHz
LQP03TQ2N3B02□	2.3nH ±0.1nH	500MHz	17	500MHz	550mA	0.15Ω	11000MHz
LQP03TQ2N3C02□	2.3nH ±0.2nH	500MHz	17	500MHz	550mA	0.15Ω	11000MHz
LQP03TQ2N4B02□	2.4nH ±0.1nH	500MHz	17	500MHz	550mA	0.15Ω	11000MHz
LQP03TQ2N4C02□	2.4nH ±0.2nH	500MHz	17	500MHz	550mA	0.15Ω	11000MHz
LQP03TQ2N5B02□	2.5nH ±0.1nH	500MHz	17	500MHz	550mA	0.15Ω	10000MHz
LQP03TQ2N5C02□	2.5nH ±0.2nH	500MHz	17	500MHz	550mA	0.15Ω	10000MHz
LQP03TQ2N6B02□	2.6nH ±0.1nH	500MHz	17	500MHz	550mA	0.15Ω	10000MHz
LQP03TQ2N6C02□	2.6nH ±0.2nH	500MHz	17	500MHz	550mA	0.15Ω	10000MHz
LQP03TQ2N7B02□	2.7nH ±0.1nH	500MHz	17	500MHz	550mA	0.15Ω	10000MHz
LQP03TQ2N7C02□	2.7nH ±0.2nH	500MHz	17	500MHz	550mA	0.15Ω	10000MHz
LQP03TQ2N8B02□	2.8nH ±0.1nH	500MHz	17	500MHz	500mA	0.2Ω	10000MHz
LQP03TQ2N8C02□	2.8nH ±0.2nH	500MHz	17	500MHz	500mA	0.2Ω	10000MHz
LQP03TQ2N9B02□	2.9nH ±0.1nH	500MHz	17	500MHz	500mA	0.2Ω	10000MHz
LQP03TQ2N9C02□	2.9nH ±0.2nH	500MHz	17	500MHz	500mA	0.2Ω	10000MHz
LQP03TQ3N0B02□	3.0nH ±0.1nH	500MHz	17	500MHz	500mA	0.2Ω	9500MHz
LQP03TQ3N0C02□	3.0nH ±0.2nH	500MHz	17	500MHz	500mA	0.2Ω	9500MHz
LQP03TQ3N1B02□	3.1nH ±0.1nH	500MHz	17	500MHz	450mA	0.24Ω	9500MHz
LQP03TQ3N1C02□	3.1nH ±0.2nH	500MHz	17	500MHz	450mA	0.24Ω	9500MHz
LQP03TQ3N2B02□	3.2nH ±0.1nH	500MHz	17	500MHz	450mA	0.24Ω	9500MHz
LQP03TQ3N2C02□	3.2nH ±0.2nH	500MHz	17	500MHz	450mA	0.24Ω	9500MHz
LQP03TQ3N3B02□	3.3nH ±0.1nH	500MHz	17	500MHz	450mA	0.24Ω	9500MHz
LQP03TQ3N3C02□	3.3nH ±0.2nH	500MHz	17	500MHz	450mA	0.24Ω	9500MHz
LQP03TQ3N4B02□	3.4nH ±0.1nH	500MHz	17	500MHz	450mA	0.25Ω	8000MHz
LQP03TQ3N4C02□	3.4nH ±0.2nH	500MHz	17	500MHz	450mA	0.25Ω	8000MHz
LQP03TQ3N5B02□	3.5nH ±0.1nH	500MHz	17	500MHz	450mA	0.25Ω	8000MHz
LQP03TQ3N5C02□	3.5nH ±0.2nH	500MHz	17	500MHz	450mA	0.25Ω	8000MHz

Operating temp. range: -55 to 125°C
 Only for reflow soldering
 *S.R.F.: Self Resonant Frequency

Continued on the following page. ↗

Inductors for Power Lines

Inductors for General Circuits

LQP03TQ_02
RF Inductors

Continued from the preceding page. ↘

Part Number (□: packaging code)	Inductance	Inductance Test Frequency	Q (min.)	Q Test Frequency	Rated Current	Max. of DC Resistance	S.R.F.* (min.)
LQP03TQ3N6B02□	3.6nH ±0.1nH	500MHz	17	500MHz	400mA	0.25Ω	8000MHz
LQP03TQ3N6C02□	3.6nH ±0.2nH	500MHz	17	500MHz	400mA	0.25Ω	8000MHz
LQP03TQ3N7B02□	3.7nH ±0.1nH	500MHz	17	500MHz	400mA	0.25Ω	6500MHz
LQP03TQ3N7C02□	3.7nH ±0.2nH	500MHz	17	500MHz	400mA	0.25Ω	6500MHz
LQP03TQ3N8B02□	3.8nH ±0.1nH	500MHz	17	500MHz	400mA	0.25Ω	6500MHz
LQP03TQ3N8C02□	3.8nH ±0.2nH	500MHz	17	500MHz	400mA	0.25Ω	6500MHz
LQP03TQ3N9B02□	3.9nH ±0.1nH	500MHz	17	500MHz	400mA	0.25Ω	6500MHz
LQP03TQ3N9C02□	3.9nH ±0.2nH	500MHz	17	500MHz	400mA	0.25Ω	6500MHz
LQP03TQ4N0B02□	4.0nH ±0.1nH	500MHz	17	500MHz	360mA	0.35Ω	6500MHz
LQP03TQ4N0C02□	4.0nH ±0.2nH	500MHz	17	500MHz	360mA	0.35Ω	6500MHz
LQP03TQ4N1B02□	4.1nH ±0.1nH	500MHz	17	500MHz	360mA	0.35Ω	6500MHz
LQP03TQ4N1C02□	4.1nH ±0.2nH	500MHz	17	500MHz	360mA	0.35Ω	6500MHz
LQP03TQ4N2B02□	4.2nH ±0.1nH	500MHz	17	500MHz	360mA	0.35Ω	6500MHz
LQP03TQ4N2C02□	4.2nH ±0.2nH	500MHz	17	500MHz	360mA	0.35Ω	6500MHz
LQP03TQ4N3H02□	4.3nH ±3%	500MHz	17	500MHz	360mA	0.35Ω	6500MHz
LQP03TQ4N3J02□	4.3nH ±5%	500MHz	17	500MHz	360mA	0.35Ω	6500MHz
LQP03TQ4N7H02□	4.7nH ±3%	500MHz	17	500MHz	350mA	0.35Ω	6500MHz
LQP03TQ4N7J02□	4.7nH ±5%	500MHz	17	500MHz	350mA	0.35Ω	6500MHz
LQP03TQ5N1H02□	5.1nH ±3%	500MHz	17	500MHz	350mA	0.39Ω	6500MHz
LQP03TQ5N1J02□	5.1nH ±5%	500MHz	17	500MHz	350mA	0.39Ω	6500MHz
LQP03TQ5N6H02□	5.6nH ±3%	500MHz	17	500MHz	350mA	0.39Ω	6000MHz
LQP03TQ5N6J02□	5.6nH ±5%	500MHz	17	500MHz	350mA	0.39Ω	6000MHz
LQP03TQ6N2H02□	6.2nH ±3%	500MHz	17	500MHz	300mA	0.55Ω	6000MHz
LQP03TQ6N2J02□	6.2nH ±5%	500MHz	17	500MHz	300mA	0.55Ω	6000MHz
LQP03TQ6N8H02□	6.8nH ±3%	500MHz	17	500MHz	300mA	0.55Ω	5400MHz
LQP03TQ6N8J02□	6.8nH ±5%	500MHz	17	500MHz	300mA	0.55Ω	5400MHz
LQP03TQ7N5H02□	7.5nH ±3%	500MHz	17	500MHz	300mA	0.55Ω	4800MHz
LQP03TQ7N5J02□	7.5nH ±5%	500MHz	17	500MHz	300mA	0.55Ω	4800MHz
LQP03TQ8N2H02□	8.2nH ±3%	500MHz	17	500MHz	250mA	0.65Ω	4800MHz
LQP03TQ8N2J02□	8.2nH ±5%	500MHz	17	500MHz	250mA	0.65Ω	4800MHz
LQP03TQ9N1H02□	9.1nH ±3%	500MHz	17	500MHz	250mA	0.65Ω	4500MHz
LQP03TQ9N1J02□	9.1nH ±5%	500MHz	17	500MHz	250mA	0.65Ω	4500MHz
LQP03TQ10NH02□	10nH ±3%	500MHz	17	500MHz	250mA	0.69Ω	4500MHz
LQP03TQ10NJ02□	10nH ±5%	500MHz	17	500MHz	250mA	0.69Ω	4500MHz
LQP03TQ11NH02□	11nH ±3%	500MHz	17	500MHz	250mA	0.69Ω	3700MHz
LQP03TQ11NJ02□	11nH ±5%	500MHz	17	500MHz	250mA	0.69Ω	3700MHz
LQP03TQ12NH02□	12nH ±3%	500MHz	17	500MHz	250mA	0.69Ω	3700MHz
LQP03TQ12NJ02□	12nH ±5%	500MHz	17	500MHz	250mA	0.69Ω	3700MHz
LQP03TQ13NH02□	13nH ±3%	500MHz	17	500MHz	250mA	0.69Ω	3700MHz
LQP03TQ13NJ02□	13nH ±5%	500MHz	17	500MHz	250mA	0.69Ω	3700MHz
LQP03TQ15NH02□	15nH ±3%	500MHz	14	500MHz	250mA	0.8Ω	3500MHz
LQP03TQ15NJ02□	15nH ±5%	500MHz	14	500MHz	250mA	0.8Ω	3500MHz
LQP03TQ16NH02□	16nH ±3%	500MHz	14	500MHz	250mA	0.8Ω	3500MHz
LQP03TQ16NJ02□	16nH ±5%	500MHz	14	500MHz	250mA	0.8Ω	3500MHz
LQP03TQ18NH02□	18nH ±3%	500MHz	14	500MHz	200mA	1.1Ω	3500MHz
LQP03TQ18NJ02□	18nH ±5%	500MHz	14	500MHz	200mA	1.1Ω	3500MHz
LQP03TQ20NH02□	20nH ±3%	500MHz	14	500MHz	200mA	1.2Ω	3000MHz
LQP03TQ20NJ02□	20nH ±5%	500MHz	14	500MHz	200mA	1.2Ω	3000MHz
LQP03TQ22NH02□	22nH ±3%	500MHz	14	500MHz	200mA	1.2Ω	3000MHz
LQP03TQ22NJ02□	22nH ±5%	500MHz	14	500MHz	200mA	1.2Ω	3000MHz
LQP03TQ24NH02□	24nH ±3%	500MHz	14	500MHz	150mA	1.6Ω	2000MHz
LQP03TQ24NJ02□	24nH ±5%	500MHz	14	500MHz	150mA	1.6Ω	2000MHz
LQP03TQ27NH02□	27nH ±3%	500MHz	14	500MHz	150mA	1.6Ω	2000MHz

Operating temp. range: -55 to 125°C
 Only for reflow soldering
 *S.R.F.: Self Resonant Frequency

Continued on the following page. ↗

Continued from the preceding page. ↘

Part Number (□: packaging code)	Inductance	Inductance Test Frequency	Q (min.)	Q Test Frequency	Rated Current	Max. of DC Resistance	S.R.F.* (min.)
LQP03TQ27NJ02□	27nH ±5%	500MHz	14	500MHz	150mA	1.6Ω	2000MHz
LQP03TQ30NH02□	30nH ±3%	500MHz	11	500MHz	150mA	2Ω	1700MHz
LQP03TQ30NJ02□	30nH ±5%	500MHz	11	500MHz	150mA	2Ω	1700MHz
LQP03TQ33NH02□	33nH ±3%	300MHz	11	300MHz	150mA	2Ω	1700MHz
LQP03TQ33NJ02□	33nH ±5%	300MHz	11	300MHz	150mA	2Ω	1700MHz
LQP03TQ36NH02□	36nH ±3%	300MHz	11	300MHz	130mA	2.5Ω	1500MHz
LQP03TQ36NJ02□	36nH ±5%	300MHz	11	300MHz	130mA	2.5Ω	1500MHz
LQP03TQ39NH02□	39nH ±3%	300MHz	11	300MHz	130mA	2.5Ω	1500MHz
LQP03TQ39NJ02□	39nH ±5%	300MHz	11	300MHz	130mA	2.5Ω	1500MHz
LQP03TQ43NH02□	43nH ±3%	300MHz	11	300MHz	130mA	4Ω	1300MHz
LQP03TQ43NJ02□	43nH ±5%	300MHz	11	300MHz	130mA	4Ω	1300MHz
LQP03TQ47NH02□	47nH ±3%	300MHz	11	300MHz	130mA	4Ω	1300MHz
LQP03TQ47NJ02□	47nH ±5%	300MHz	11	300MHz	130mA	4Ω	1300MHz
LQP03TQ51NH02□	51nH ±3%	300MHz	11	300MHz	100mA	6Ω	1200MHz
LQP03TQ51NJ02□	51nH ±5%	300MHz	11	300MHz	100mA	6Ω	1200MHz
LQP03TQ56NH02□	56nH ±3%	300MHz	11	300MHz	100mA	6Ω	1200MHz
LQP03TQ56NJ02□	56nH ±5%	300MHz	11	300MHz	100mA	6Ω	1200MHz
LQP03TQ62NH02□	62nH ±3%	300MHz	9	300MHz	80mA	7Ω	1100MHz
LQP03TQ62NJ02□	62nH ±5%	300MHz	9	300MHz	80mA	7Ω	1100MHz
LQP03TQ68NH02□	68nH ±3%	300MHz	9	300MHz	80mA	7Ω	1100MHz
LQP03TQ68NJ02□	68nH ±5%	300MHz	9	300MHz	80mA	7Ω	1100MHz
LQP03TQ75NH02□	75nH ±3%	300MHz	9	300MHz	80mA	7Ω	1100MHz
LQP03TQ75NJ02□	75nH ±5%	300MHz	9	300MHz	80mA	7Ω	1100MHz
LQP03TQ82NH02□	82nH ±3%	300MHz	9	300MHz	80mA	7Ω	1000MHz
LQP03TQ82NJ02□	82nH ±5%	300MHz	9	300MHz	80mA	7Ω	1000MHz
LQP03TQ91NH02□	91nH ±3%	300MHz	9	300MHz	70mA	8Ω	1000MHz
LQP03TQ91NJ02□	91nH ±5%	300MHz	9	300MHz	70mA	8Ω	1000MHz
LQP03TQR10H02□	100nH ±3%	300MHz	9	300MHz	70mA	9Ω	900MHz
LQP03TQR10J02□	100nH ±5%	300MHz	9	300MHz	70mA	9Ω	900MHz
LQP03TQR11H02□	110nH ±3%	300MHz	9	300MHz	70mA	9Ω	900MHz
LQP03TQR11J02□	110nH ±5%	300MHz	9	300MHz	70mA	9Ω	900MHz

Operating temp. range: -55 to 125°C

Only for reflow soldering

*S.R.F.: Self Resonant Frequency

Inductance-Frequency Characteristics (Typ.)



Q-Frequency Characteristics (Typ.)



LQP15MN_02 Series 0402 (1005) inch (mm)



Packaging Code	Packaging	Minimum Quantity
D	ø180mm Paper Taping	10000
J	ø330mm Paper Taping	50000
B	Packing in Bulk	500

(in mm)

Part Number (□: packaging code)	Inductance	Inductance Test Frequency	Q (min.)	Q Test Frequency	Rated Current	Max. of DC Resistance	S.R.F.* (min.)
LQP15MN1N0W02□	1.0nH ±0.05nH	500MHz	13	500MHz	400mA	0.1Ω	6000MHz
LQP15MN1N0B02□	1.0nH ±0.1nH	500MHz	13	500MHz	400mA	0.1Ω	6000MHz
LQP15MN1N1W02□	1.1nH ±0.05nH	500MHz	13	500MHz	390mA	0.1Ω	6000MHz
LQP15MN1N1B02□	1.1nH ±0.1nH	500MHz	13	500MHz	390mA	0.1Ω	6000MHz
LQP15MN1N2W02□	1.2nH ±0.05nH	500MHz	13	500MHz	390mA	0.1Ω	6000MHz
LQP15MN1N2B02□	1.2nH ±0.1nH	500MHz	13	500MHz	390mA	0.1Ω	6000MHz
LQP15MN1N3W02□	1.3nH ±0.05nH	500MHz	13	500MHz	280mA	0.2Ω	6000MHz
LQP15MN1N3B02□	1.3nH ±0.1nH	500MHz	13	500MHz	280mA	0.2Ω	6000MHz
LQP15MN1N4W02□	1.4nH ±0.05nH	500MHz	13	500MHz	280mA	0.2Ω	6000MHz
LQP15MN1N5W02□	1.5nH ±0.05nH	500MHz	13	500MHz	280mA	0.2Ω	6000MHz
LQP15MN1N5B02□	1.5nH ±0.1nH	500MHz	13	500MHz	280mA	0.2Ω	6000MHz
LQP15MN1N6W02□	1.6nH ±0.05nH	500MHz	13	500MHz	220mA	0.3Ω	6000MHz
LQP15MN1N6B02□	1.6nH ±0.1nH	500MHz	13	500MHz	220mA	0.3Ω	6000MHz
LQP15MN1N7W02□	1.7nH ±0.05nH	500MHz	13	500MHz	280mA	0.2Ω	6000MHz
LQP15MN1N8W02□	1.8nH ±0.05nH	500MHz	13	500MHz	280mA	0.2Ω	6000MHz
LQP15MN1N8B02□	1.8nH ±0.1nH	500MHz	13	500MHz	280mA	0.2Ω	6000MHz
LQP15MN1N9W02□	1.9nH ±0.05nH	500MHz	13	500MHz	220mA	0.3Ω	6000MHz
LQP15MN2N0W02□	2.0nH ±0.05nH	500MHz	13	500MHz	220mA	0.3Ω	6000MHz
LQP15MN2N0B02□	2.0nH ±0.1nH	500MHz	13	500MHz	220mA	0.3Ω	6000MHz
LQP15MN2N1W02□	2.1nH ±0.05nH	500MHz	13	500MHz	220mA	0.3Ω	6000MHz
LQP15MN2N2W02□	2.2nH ±0.05nH	500MHz	13	500MHz	220mA	0.3Ω	6000MHz
LQP15MN2N2B02□	2.2nH ±0.1nH	500MHz	13	500MHz	220mA	0.3Ω	6000MHz
LQP15MN2N3W02□	2.3nH ±0.05nH	500MHz	13	500MHz	220mA	0.3Ω	6000MHz
LQP15MN2N4W02□	2.4nH ±0.05nH	500MHz	13	500MHz	220mA	0.3Ω	6000MHz
LQP15MN2N4B02□	2.4nH ±0.1nH	500MHz	13	500MHz	220mA	0.3Ω	6000MHz
LQP15MN2N5W02□	2.5nH ±0.05nH	500MHz	13	500MHz	220mA	0.3Ω	6000MHz
LQP15MN2N6W02□	2.6nH ±0.05nH	500MHz	13	500MHz	220mA	0.3Ω	6000MHz
LQP15MN2N7W02□	2.7nH ±0.05nH	500MHz	13	500MHz	220mA	0.3Ω	6000MHz
LQP15MN2N7B02□	2.7nH ±0.1nH	500MHz	13	500MHz	220mA	0.3Ω	6000MHz
LQP15MN2N8W02□	2.8nH ±0.05nH	500MHz	13	500MHz	190mA	0.4Ω	6000MHz
LQP15MN2N9W02□	2.9nH ±0.05nH	500MHz	13	500MHz	190mA	0.4Ω	6000MHz
LQP15MN3N0W02□	3.0nH ±0.05nH	500MHz	13	500MHz	190mA	0.4Ω	6000MHz
LQP15MN3N0B02□	3.0nH ±0.1nH	500MHz	13	500MHz	190mA	0.4Ω	6000MHz
LQP15MN3N1W02□	3.1nH ±0.05nH	500MHz	13	500MHz	190mA	0.4Ω	6000MHz
LQP15MN3N2W02□	3.2nH ±0.05nH	500MHz	13	500MHz	190mA	0.4Ω	6000MHz
LQP15MN3N3W02□	3.3nH ±0.05nH	500MHz	13	500MHz	190mA	0.4Ω	6000MHz
LQP15MN3N3B02□	3.3nH ±0.1nH	500MHz	13	500MHz	190mA	0.4Ω	6000MHz
LQP15MN3N4W02□	3.4nH ±0.05nH	500MHz	13	500MHz	170mA	0.5Ω	6000MHz
LQP15MN3N5W02□	3.5nH ±0.05nH	500MHz	13	500MHz	170mA	0.5Ω	6000MHz
LQP15MN3N6W02□	3.6nH ±0.05nH	500MHz	13	500MHz	170mA	0.5Ω	6000MHz

Operating temp. range: -40 to 85°C

Only for reflow soldering

*S.R.F.: Self Resonant Frequency

Continued on the following page. ↗

Continued from the preceding page. ↘

Part Number (□: packaging code)	Inductance	Inductance Test Frequency	Q (min.)	Q Test Frequency	Rated Current	Max. of DC Resistance	S.R.F.* (min.)
LQP15MN3N6B02□	3.6nH ±0.1nH	500MHz	13	500MHz	170mA	0.5Ω	6000MHz
LQP15MN3N7W02□	3.7nH ±0.05nH	500MHz	13	500MHz	170mA	0.5Ω	6000MHz
LQP15MN3N8W02□	3.8nH ±0.05nH	500MHz	13	500MHz	170mA	0.5Ω	6000MHz
LQP15MN3N9W02□	3.9nH ±0.05nH	500MHz	13	500MHz	170mA	0.5Ω	6000MHz
LQP15MN3N9B02□	3.9nH ±0.1nH	500MHz	13	500MHz	170mA	0.5Ω	6000MHz
LQP15MN4N3B02□	4.3nH ±0.1nH	500MHz	13	500MHz	160mA	0.6Ω	6000MHz
LQP15MN4N7B02□	4.7nH ±0.1nH	500MHz	13	500MHz	160mA	0.6Ω	6000MHz
LQP15MN5N1B02□	5.1nH ±0.1nH	500MHz	13	500MHz	140mA	0.7Ω	6000MHz
LQP15MN5N6B02□	5.6nH ±0.1nH	500MHz	13	500MHz	140mA	0.7Ω	6000MHz
LQP15MN6N2B02□	6.2nH ±0.1nH	500MHz	13	500MHz	130mA	0.9Ω	6000MHz
LQP15MN6N8B02□	6.8nH ±0.1nH	500MHz	13	500MHz	130mA	0.9Ω	6000MHz
LQP15MN7N5B02□	7.5nH ±0.1nH	500MHz	13	500MHz	110mA	1.1Ω	5500MHz
LQP15MN8N2B02□	8.2nH ±0.1nH	500MHz	13	500MHz	110mA	1.1Ω	5500MHz
LQP15MN9N1B02□	9.1nH ±0.1nH	500MHz	13	500MHz	100mA	1.3Ω	4500MHz
LQP15MN10NG02□	10nH ±2%	500MHz	13	500MHz	100mA	1.3Ω	4500MHz
LQP15MN12NG02□	12nH ±2%	500MHz	13	500MHz	90mA	1.6Ω	3700MHz
LQP15MN15NG02□	15nH ±2%	500MHz	13	500MHz	90mA	1.8Ω	3300MHz
LQP15MN18NG02□	18nH ±2%	500MHz	13	500MHz	80mA	2.0Ω	3100MHz
LQP15MN22NG02□	22nH ±2%	500MHz	13	500MHz	70mA	2.6Ω	2800MHz
LQP15MN27NG02□	27nH ±2%	500MHz	13	500MHz	70mA	3.1Ω	2500MHz
LQP15MN33NG02□	33nH ±2%	500MHz	13	500MHz	60mA	3.8Ω	2100MHz

Operating temp. range: -40 to 85°C

Only for reflow soldering

*S.R.F.: Self Resonant Frequency

Inductance-Frequency Characteristics (Typ.)



Q-Frequency Characteristics (Typ.)



LQP18MN_02 Series 0603 (1608) inch (mm)



Packaging Code	Packaging	Minimum Quantity
D	ø180mm Paper Taping	4000
J	ø330mm Paper Taping	10000
B	Packing in Bulk	500

Continued on the following page. ↗

Continued from the preceding page. ↘

Part Number (□: packaging code)	Inductance	Inductance Test Frequency	Q (min.)	Q Test Frequency	Rated Current	Max. of DC Resistance	S.R.F.* (min.)
LQP18MN1N3C02□	1.3nH ±0.2nH	500MHz	17	500MHz	300mA	0.3Ω	6000MHz
LQP18MN1N5C02□	1.5nH ±0.2nH	500MHz	17	500MHz	300mA	0.3Ω	6000MHz
LQP18MN1N8C02□	1.8nH ±0.2nH	500MHz	17	500MHz	250mA	0.4Ω	6000MHz
LQP18MN2N2C02□	2.2nH ±0.2nH	500MHz	17	500MHz	250mA	0.4Ω	6000MHz
LQP18MN2N7C02□	2.7nH ±0.2nH	500MHz	17	500MHz	250mA	0.4Ω	6000MHz
LQP18MN3N3C02□	3.3nH ±0.2nH	500MHz	17	500MHz	250mA	0.4Ω	6000MHz
LQP18MN3N9C02□	3.9nH ±0.2nH	500MHz	17	500MHz	200mA	0.5Ω	5900MHz
LQP18MN4N7C02□	4.7nH ±0.2nH	500MHz	17	500MHz	200mA	0.5Ω	5200MHz
LQP18MN5N6C02□	5.6nH ±0.2nH	500MHz	17	500MHz	200mA	0.6Ω	4700MHz
LQP18MN6N8C02□	6.8nH ±0.2nH	500MHz	17	500MHz	200mA	0.7Ω	4300MHz
LQP18MN8N2C02□	8.2nH ±0.2nH	500MHz	17	500MHz	150mA	0.8Ω	3600MHz
LQP18MN10NG02□	10nH ±2%	500MHz	17	500MHz	150mA	1.0Ω	3400MHz
LQP18MN12NG02□	12nH ±2%	500MHz	17	500MHz	150mA	1.0Ω	3000MHz
LQP18MN15NG02□	15nH ±2%	500MHz	17	500MHz	150mA	1.3Ω	2700MHz
LQP18MN18NG02□	18nH ±2%	500MHz	17	500MHz	100mA	1.5Ω	2300MHz
LQP18MN22NG02□	22nH ±2%	500MHz	17	500MHz	100mA	1.9Ω	2100MHz
LQP18MN27NG02□	27nH ±2%	500MHz	17	500MHz	100mA	2.4Ω	1900MHz
LQP18MN33NG02□	33nH ±2%	500MHz	17	500MHz	100mA	2.8Ω	1700MHz
LQP18MN39NG02□	39nH ±2%	500MHz	17	500MHz	100mA	2.8Ω	1400MHz
LQP18MN47NG02□	47nH ±2%	300MHz	17	300MHz	100mA	2.2Ω	1200MHz
LQP18MN56NG02□	56nH ±2%	300MHz	17	300MHz	50mA	3.4Ω	1000MHz
LQP18MN68NG02□	68nH ±2%	300MHz	17	300MHz	50mA	3.5Ω	900MHz
LQP18MN82NG02□	82nH ±2%	300MHz	17	300MHz	50mA	4.6Ω	800MHz
LQP18MNR10G02□	100nH ±2%	300MHz	17	300MHz	50mA	6.1Ω	700MHz

Operating temp. range: -40 to 85°C

Only for reflow soldering

*S.R.F.: Self Resonant Frequency

Inductance-Frequency Characteristics (Typ.)



Q-Frequency Characteristics (Typ.)



LQW03AW_00 Series 0201 (0603) inch (mm)

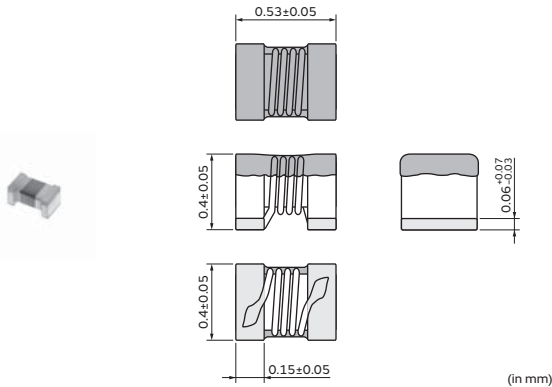

Packaging Code	Packaging	Minimum Quantity
D	ø180mm Paper Taping	10000

Continued on the following page. ↗

Continued from the preceding page. ↘

Part Number (□: packaging code)	Inductance	Inductance Test Frequency	Q (min.)	Q Test Frequency	Rated Current	Max. of DC Resistance	S.R.F.* (min.)
LQW03AW1N0C00□	1.0nH ±0.2nH	250MHz	48(Typ.)	900MHz	900mA	0.03Ω	19GHz
LQW03AW1N1C00□	1.1nH ±0.2nH	250MHz	41(Typ.)	900MHz	660mA	0.06Ω	19GHz
LQW03AW1N7C00□	1.7nH ±0.2nH	250MHz	41(Typ.)	900MHz	600mA	0.07Ω	19GHz
LQW03AW1N8C00□	1.8nH ±0.2nH	250MHz	37(Typ.)	900MHz	520mA	0.1Ω	19GHz
LQW03AW1N9C00□	1.9nH ±0.2nH	250MHz	41(Typ.)	900MHz	620mA	0.08Ω	19GHz
LQW03AW2N0C00□	2.0nH ±0.2nH	250MHz	42(Typ.)	900MHz	490mA	0.1Ω	19GHz
LQW03AW2N1C00□	2.1nH ±0.2nH	250MHz	35(Typ.)	900MHz	400mA	0.16Ω	19GHz
LQW03AW2N2C00□	2.2nH ±0.2nH	250MHz	33(Typ.)	900MHz	400mA	0.16Ω	19GHz
LQW03AW2N7C00□	2.7nH ±0.2nH	250MHz	46(Typ.)	900MHz	720mA	0.06Ω	15GHz
LQW03AW2N8C00□	2.8nH ±0.2nH	250MHz	44(Typ.)	900MHz	600mA	0.08Ω	14GHz
LQW03AW2N9C00□	2.9nH ±0.2nH	250MHz	41(Typ.)	900MHz	540mA	0.1Ω	13GHz
LQW03AW3N0C00□	3.0nH ±0.2nH	250MHz	34(Typ.)	900MHz	350mA	0.22Ω	14GHz
LQW03AW3N1C00□	3.1nH ±0.2nH	250MHz	48(Typ.)	900MHz	720mA	0.07Ω	12GHz
LQW03AW3N2C00□	3.2nH ±0.2nH	250MHz	48(Typ.)	900MHz	580mA	0.08Ω	10GHz
LQW03AW3N3C00□	3.3nH ±0.2nH	250MHz	47(Typ.)	900MHz	520mA	0.11Ω	11GHz
LQW03AW3N4C00□	3.4nH ±0.2nH	250MHz	43(Typ.)	900MHz	440mA	0.15Ω	11GHz
LQW03AW3N5C00□	3.5nH ±0.2nH	250MHz	43(Typ.)	900MHz	440mA	0.15Ω	12GHz
LQW03AW3N6C00□	3.6nH ±0.2nH	250MHz	36(Typ.)	900MHz	340mA	0.23Ω	11GHz
LQW03AW3N7C00□	3.7nH ±0.2nH	250MHz	38(Typ.)	900MHz	340mA	0.23Ω	11GHz
LQW03AW3N9C00□	3.9nH ±0.2nH	250MHz	48(Typ.)	900MHz	650mA	0.07Ω	11GHz
LQW03AW4N3J00□	4.3nH ±5%	100MHz	45(Typ.)	900MHz	480mA	0.12Ω	11GHz
LQW03AW4N7J00□	4.7nH ±5%	100MHz	45(Typ.)	900MHz	620mA	0.09Ω	9.5GHz
LQW03AW5N1J00□	5.1nH ±5%	100MHz	45(Typ.)	900MHz	480mA	0.14Ω	9.5GHz
LQW03AW5N4J00□	5.4nH ±5%	100MHz	46 (Typ.)	900MHz	420mA	0.21Ω	9.5GHz
LQW03AW5N6J00□	5.6nH ±5%	100MHz	37 (Typ.)	900MHz	330mA	0.33Ω	8.3GHz
LQW03AW5N8J00□	5.8nH ±5%	100MHz	47 (Typ.)	900MHz	460mA	0.16Ω	8.8GHz
LQW03AW6N2J00□	6.2nH ±5%	100MHz	39(Typ.)	900MHz	360mA	0.22Ω	9.9GHz
LQW03AW6N8J00□	6.8nH ±5%	100MHz	42 (Typ.)	900MHz	460mA	0.18Ω	7.7GHz
LQW03AW7N5J00□	7.5nH ±5%	100MHz	41 (Typ.)	900MHz	400mA	0.24Ω	7.5GHz
LQW03AW8N2J00□	8.2nH ±5%	100MHz	40(Typ.)	900MHz	290mA	0.26Ω	8.5GHz
LQW03AW8N7J00□	8.7nH ±5%	100MHz	39 (Typ.)	900MHz	290mA	0.42Ω	7.5GHz
LQW03AW9N1J00□	9.1nH ±5%	100MHz	46 (Typ.)	900MHz	460mA	0.22Ω	6.4GHz
LQW03AW10NJ00□	10nH ±5%	100MHz	37(Typ.)	900MHz	250mA	0.46Ω	7.2GHz
LQW03AW11NJ00□	11nH ±5%	100MHz	37(Typ.)	900MHz	260mA	0.47Ω	7GHz
LQW03AW12NJ00□	12.5nH ±5%	100MHz	39(Typ.)	900MHz	280mA	0.54Ω	6GHz
LQW03AW13NJ00□	13nH ±5%	100MHz	39 (Typ.)	900MHz	280mA	0.54Ω	5.9GHz
LQW03AW14NJ00□	13.5nH ±5%	100MHz	37(Typ.)	900MHz	240mA	0.53Ω	6GHz
LQW03AW15NJ00□	15.5nH ±5%	100MHz	38(Typ.)	900MHz	230mA	0.6Ω	5.7GHz

Operating temp. range (Self-temp. rise included): -55 to 125°C

Only for reflow soldering

*S.R.F.: Self Resonant Frequency

Inductance-Frequency Characteristics (Typ.)



Q-Frequency Characteristics (Typ.)



LQW04AN_00 Series 03015 (0804) inch (mm)



(in mm)

Packaging Code	Packaging	Minimum Quantity
D	ø180mm Paper Taping	10000
B	Packing in Bulk	500

Part Number (□: packaging code)	Inductance	Inductance Test Frequency	Q (min.)	Q Test Frequency	Rated Current	Max. of DC Resistance	S.R.F.* (min.)
LQW04AN0N8C00□	0.8nH ±0.2nH	100MHz	23	250MHz	1800mA	0.02Ω	20.0GHz
LQW04AN0N8D00□	0.8nH ±0.5nH	100MHz	23	250MHz	1800mA	0.02Ω	20.0GHz
LQW04AN1N1C00□	1.1nH ±0.2nH	100MHz	15	250MHz	990mA	0.03Ω	20.0GHz
LQW04AN1N1D00□	1.1nH ±0.5nH	100MHz	15	250MHz	990mA	0.03Ω	20.0GHz
LQW04AN1N3C00□	1.3nH ±0.2nH	100MHz	15	250MHz	1500mA	0.03Ω	20.0GHz
LQW04AN1N3D00□	1.3nH ±0.5nH	100MHz	15	250MHz	1500mA	0.03Ω	20.0GHz
LQW04AN1N4C00□	1.4nH ±0.2nH	100MHz	15	250MHz	1200mA	0.03Ω	20.0GHz
LQW04AN1N4D00□	1.4nH ±0.5nH	100MHz	15	250MHz	1200mA	0.03Ω	20.0GHz
LQW04AN1N5C00□	1.5nH ±0.2nH	100MHz	18	250MHz	940mA	0.05Ω	20.0GHz
LQW04AN1N5D00□	1.5nH ±0.5nH	100MHz	18	250MHz	940mA	0.05Ω	20.0GHz
LQW04AN1N6C00□	1.6nH ±0.2nH	100MHz	15	250MHz	700mA	0.06Ω	17.0GHz
LQW04AN1N6D00□	1.6nH ±0.5nH	100MHz	15	250MHz	700mA	0.06Ω	17.0GHz
LQW04AN1N7C00□	1.7nH ±0.2nH	100MHz	15	250MHz	700mA	0.06Ω	17.0GHz
LQW04AN1N7D00□	1.7nH ±0.5nH	100MHz	15	250MHz	700mA	0.06Ω	17.0GHz
LQW04AN1N8C00□	1.8nH ±0.2nH	100MHz	15	250MHz	700mA	0.06Ω	17.0GHz
LQW04AN1N8D00□	1.8nH ±0.5nH	100MHz	15	250MHz	700mA	0.06Ω	17.0GHz
LQW04AN1N9C00□	1.9nH ±0.2nH	100MHz	10	250MHz	490mA	0.12Ω	15.0GHz
LQW04AN1N9D00□	1.9nH ±0.5nH	100MHz	10	250MHz	490mA	0.12Ω	15.0GHz
LQW04AN2N0C00□	2.0nH ±0.2nH	100MHz	21	250MHz	1100mA	0.03Ω	20.0GHz
LQW04AN2N0D00□	2.0nH ±0.5nH	100MHz	21	250MHz	1100mA	0.03Ω	20.0GHz
LQW04AN2N1C00□	2.1nH ±0.2nH	100MHz	14	250MHz	1100mA	0.03Ω	12.0GHz
LQW04AN2N1D00□	2.1nH ±0.5nH	100MHz	14	250MHz	1100mA	0.03Ω	12.0GHz
LQW04AN2N2C00□	2.2nH ±0.2nH	100MHz	21	250MHz	1100mA	0.04Ω	12.0GHz
LQW04AN2N2D00□	2.2nH ±0.5nH	100MHz	21	250MHz	1100mA	0.04Ω	12.0GHz
LQW04AN2N3C00□	2.3nH ±0.2nH	100MHz	18	250MHz	780mA	0.07Ω	20.0GHz
LQW04AN2N3D00□	2.3nH ±0.5nH	100MHz	18	250MHz	780mA	0.07Ω	20.0GHz
LQW04AN2N4C00□	2.4nH ±0.2nH	100MHz	15	250MHz	570mA	0.07Ω	15.0GHz
LQW04AN2N4D00□	2.4nH ±0.5nH	100MHz	15	250MHz	570mA	0.07Ω	15.0GHz
LQW04AN2N5C00□	2.5nH ±0.2nH	100MHz	10	250MHz	490mA	0.12Ω	10.0GHz
LQW04AN2N5D00□	2.5nH ±0.5nH	100MHz	10	250MHz	490mA	0.12Ω	10.0GHz
LQW04AN2N6C00□	2.6nH ±0.2nH	100MHz	15	250MHz	620mA	0.07Ω	15.0GHz
LQW04AN2N6D00□	2.6nH ±0.5nH	100MHz	15	250MHz	620mA	0.07Ω	15.0GHz
LQW04AN2N7C00□	2.7nH ±0.2nH	100MHz	15	250MHz	570mA	0.07Ω	15.0GHz
LQW04AN2N7D00□	2.7nH ±0.5nH	100MHz	15	250MHz	570mA	0.07Ω	15.0GHz
LQW04AN2N8C00□	2.8nH ±0.2nH	100MHz	15	250MHz	620mA	0.07Ω	15.0GHz
LQW04AN2N8D00□	2.8nH ±0.5nH	100MHz	15	250MHz	620mA	0.07Ω	15.0GHz
LQW04AN2N9C00□	2.9nH ±0.2nH	100MHz	10	250MHz	490mA	0.12Ω	13.0GHz
LQW04AN2N9D00□	2.9nH ±0.5nH	100MHz	10	250MHz	490mA	0.12Ω	13.0GHz
LQW04AN3N0C00□	3.0nH ±0.2nH	100MHz	15	250MHz	620mA	0.07Ω	13.0GHz
LQW04AN3N0D00□	3.0nH ±0.5nH	100MHz	15	250MHz	620mA	0.07Ω	13.0GHz

Operating temp. range: -55 to 125°C

Only for reflow soldering

*S.R.F.: Self Resonant Frequency

Continued on the following page. ↗

Continued from the preceding page. ↘

Part Number (□: packaging code)	Inductance	Inductance Test Frequency	Q (min.)	Q Test Frequency	Rated Current	Max. of DC Resistance	S.R.F.* (min.)
LQW04AN3N1C00□	3.1nH ±0.2nH	100MHz	10	250MHz	490mA	0.12Ω	10.0GHz
LQW04AN3N1D00□	3.1nH ±0.5nH	100MHz	10	250MHz	490mA	0.12Ω	10.0GHz
LQW04AN3N2C00□	3.2nH ±0.2nH	100MHz	10	250MHz	400mA	0.17Ω	9.0GHz
LQW04AN3N2D00□	3.2nH ±0.5nH	100MHz	10	250MHz	400mA	0.17Ω	9.0GHz
LQW04AN3N3C00□	3.3nH ±0.2nH	100MHz	10	250MHz	440mA	0.14Ω	10.0GHz
LQW04AN3N3D00□	3.3nH ±0.5nH	100MHz	10	250MHz	440mA	0.14Ω	10.0GHz
LQW04AN3N4C00□	3.4nH ±0.2nH	100MHz	10	250MHz	310mA	0.27Ω	8.0GHz
LQW04AN3N4D00□	3.4nH ±0.5nH	100MHz	10	250MHz	310mA	0.27Ω	8.0GHz
LQW04AN3N6C00□	3.6nH ±0.2nH	100MHz	15	250MHz	530mA	0.10Ω	13.0GHz
LQW04AN3N6D00□	3.6nH ±0.5nH	100MHz	15	250MHz	530mA	0.10Ω	13.0GHz
LQW04AN3N7C00□	3.7nH ±0.2nH	100MHz	20	250MHz	440mA	0.14Ω	10.0GHz
LQW04AN3N7D00□	3.7nH ±0.5nH	100MHz	20	250MHz	440mA	0.14Ω	10.0GHz
LQW04AN3N8C00□	3.8nH ±0.2nH	100MHz	15	250MHz	530mA	0.10Ω	11.0GHz
LQW04AN3N8D00□	3.8nH ±0.5nH	100MHz	15	250MHz	530mA	0.10Ω	11.0GHz
LQW04AN3N9C00□	3.9nH ±0.2nH	100MHz	15	250MHz	530mA	0.10Ω	12.0GHz
LQW04AN3N9D00□	3.9nH ±0.5nH	100MHz	15	250MHz	530mA	0.10Ω	12.0GHz
LQW04AN4N0C00□	4nH ±0.2nH	100MHz	15	250MHz	530mA	0.10Ω	11.0GHz
LQW04AN4N0D00□	4nH ±0.5nH	100MHz	15	250MHz	530mA	0.10Ω	11.0GHz
LQW04AN4N1C00□	4.1nH ±0.2nH	100MHz	15	250MHz	530mA	0.10Ω	11.0GHz
LQW04AN4N1D00□	4.1nH ±0.5nH	100MHz	15	250MHz	530mA	0.10Ω	11.0GHz
LQW04AN4N2C00□	4.2nH ±0.2nH	100MHz	15	250MHz	530mA	0.10Ω	11.0GHz
LQW04AN4N2D00□	4.2nH ±0.5nH	100MHz	15	250MHz	530mA	0.10Ω	11.0GHz
LQW04AN4N3C00□	4.3nH ±0.2nH	100MHz	15	250MHz	530mA	0.10Ω	11.0GHz
LQW04AN4N3D00□	4.3nH ±0.5nH	100MHz	15	250MHz	530mA	0.10Ω	11.0GHz
LQW04AN4N4C00□	4.4nH ±0.2nH	100MHz	20	250MHz	440mA	0.14Ω	10.0GHz
LQW04AN4N4D00□	4.4nH ±0.5nH	100MHz	20	250MHz	440mA	0.14Ω	10.0GHz
LQW04AN4N5C00□	4.5nH ±0.2nH	100MHz	20	250MHz	440mA	0.14Ω	10.0GHz
LQW04AN4N5D00□	4.5nH ±0.5nH	100MHz	20	250MHz	440mA	0.14Ω	10.0GHz
LQW04AN4N6C00□	4.6nH ±0.2nH	100MHz	20	250MHz	440mA	0.14Ω	10.0GHz
LQW04AN4N6D00□	4.6nH ±0.5nH	100MHz	20	250MHz	440mA	0.14Ω	10.0GHz
LQW04AN4N7C00□	4.7nH ±0.2nH	100MHz	20	250MHz	440mA	0.14Ω	10.0GHz
LQW04AN4N7D00□	4.7nH ±0.5nH	100MHz	20	250MHz	440mA	0.14Ω	10.0GHz
LQW04AN4N8C00□	4.8nH ±0.2nH	100MHz	15	250MHz	350mA	0.23Ω	9.0GHz
LQW04AN4N8D00□	4.8nH ±0.5nH	100MHz	15	250MHz	350mA	0.23Ω	9.0GHz
LQW04AN4N9C00□	4.9nH ±0.2nH	100MHz	15	250MHz	350mA	0.23Ω	9.0GHz
LQW04AN4N9D00□	4.9nH ±0.5nH	100MHz	15	250MHz	350mA	0.23Ω	9.0GHz
LQW04AN5N0C00□	5nH ±0.2nH	100MHz	15	250MHz	350mA	0.23Ω	9.0GHz
LQW04AN5N0D00□	5nH ±0.5nH	100MHz	15	250MHz	350mA	0.23Ω	9.0GHz
LQW04AN5N1C00□	5.1nH ±0.2nH	100MHz	20	250MHz	470mA	0.12Ω	10.0GHz
LQW04AN5N1D00□	5.1nH ±0.5nH	100MHz	20	250MHz	470mA	0.12Ω	10.0GHz
LQW04AN5N2C00□	5.2nH ±0.2nH	100MHz	20	250MHz	390mA	0.19Ω	9.0GHz
LQW04AN5N2D00□	5.2nH ±0.5nH	100MHz	20	250MHz	390mA	0.19Ω	9.0GHz
LQW04AN5N3C00□	5.3nH ±0.2nH	100MHz	20	250MHz	390mA	0.19Ω	9.0GHz
LQW04AN5N3D00□	5.3nH ±0.5nH	100MHz	20	250MHz	390mA	0.19Ω	9.0GHz
LQW04AN5N4C00□	5.4nH ±0.2nH	100MHz	20	250MHz	390mA	0.19Ω	9.0GHz
LQW04AN5N4D00□	5.4nH ±0.5nH	100MHz	20	250MHz	390mA	0.19Ω	9.0GHz
LQW04AN5N5C00□	5.5nH ±0.2nH	100MHz	20	250MHz	470mA	0.12Ω	9.0GHz
LQW04AN5N5D00□	5.5nH ±0.5nH	100MHz	20	250MHz	470mA	0.12Ω	9.0GHz
LQW04AN5N6C00□	5.6nH ±0.2nH	100MHz	20	250MHz	470mA	0.12Ω	9.0GHz
LQW04AN5N6D00□	5.6nH ±0.5nH	100MHz	20	250MHz	470mA	0.12Ω	9.0GHz
LQW04AN5N7C00□	5.7nH ±0.2nH	100MHz	20	250MHz	390mA	0.19Ω	9.0GHz
LQW04AN5N7D00□	5.7nH ±0.5nH	100MHz	20	250MHz	390mA	0.19Ω	9.0GHz
LQW04AN5N8C00□	5.8nH ±0.2nH	100MHz	20	250MHz	390mA	0.19Ω	9.0GHz

Operating temp. range: -55 to 125°C

Only for reflow soldering

*S.R.F.: Self Resonant Frequency

Continued on the following page. ↗

Continued from the preceding page. ↘

Part Number (□: packaging code)	Inductance	Inductance Test Frequency	Q (min.)	Q Test Frequency	Rated Current	Max. of DC Resistance	S.R.F.* (min.)
LQW04AN5N8D00□	5.8nH ±0.5nH	100MHz	20	250MHz	390mA	0.19Ω	9.0GHz
LQW04AN5N9C00□	5.9nH ±0.2nH	100MHz	20	250MHz	390mA	0.19Ω	9.0GHz
LQW04AN5N9D00□	5.9nH ±0.5nH	100MHz	20	250MHz	390mA	0.19Ω	9.0GHz
LQW04AN6N0C00□	6nH ±0.2nH	100MHz	20	250MHz	390mA	0.19Ω	9.0GHz
LQW04AN6N0D00□	6nH ±0.5nH	100MHz	20	250MHz	390mA	0.19Ω	9.0GHz
LQW04AN6N1C00□	6.1nH ±0.2nH	100MHz	20	250MHz	390mA	0.19Ω	9.0GHz
LQW04AN6N1D00□	6.1nH ±0.5nH	100MHz	20	250MHz	390mA	0.19Ω	9.0GHz
LQW04AN6N2C00□	6.2nH ±0.2nH	100MHz	20	250MHz	390mA	0.19Ω	9.0GHz
LQW04AN6N2D00□	6.2nH ±0.5nH	100MHz	20	250MHz	390mA	0.19Ω	9.0GHz
LQW04AN6N3C00□	6.3nH ±0.2nH	100MHz	20	250MHz	390mA	0.19Ω	9.0GHz
LQW04AN6N3D00□	6.3nH ±0.5nH	100MHz	20	250MHz	390mA	0.19Ω	9.0GHz
LQW04AN6N4C00□	6.4nH ±0.2nH	100MHz	20	250MHz	390mA	0.19Ω	9.0GHz
LQW04AN6N4D00□	6.4nH ±0.5nH	100MHz	20	250MHz	390mA	0.19Ω	9.0GHz
LQW04AN6N5C00□	6.5nH ±0.2nH	100MHz	20	250MHz	390mA	0.19Ω	9.0GHz
LQW04AN6N5D00□	6.5nH ±0.5nH	100MHz	20	250MHz	390mA	0.19Ω	9.0GHz
LQW04AN6N6C00□	6.6nH ±0.2nH	100MHz	20	250MHz	390mA	0.19Ω	9.0GHz
LQW04AN6N6D00□	6.6nH ±0.5nH	100MHz	20	250MHz	390mA	0.19Ω	9.0GHz
LQW04AN6N7C00□	6.7nH ±0.2nH	100MHz	20	250MHz	390mA	0.19Ω	9.0GHz
LQW04AN6N7D00□	6.7nH ±0.5nH	100MHz	20	250MHz	390mA	0.19Ω	9.0GHz
LQW04AN6N8C00□	6.8nH ±0.2nH	100MHz	20	250MHz	440mA	0.14Ω	9.0GHz
LQW04AN6N8D00□	6.8nH ±0.5nH	100MHz	20	250MHz	440mA	0.14Ω	9.0GHz
LQW04AN6N9C00□	6.9nH ±0.2nH	100MHz	20	250MHz	440mA	0.14Ω	8.0GHz
LQW04AN6N9D00□	6.9nH ±0.5nH	100MHz	20	250MHz	440mA	0.14Ω	8.0GHz
LQW04AN7N0C00□	7nH ±0.2nH	100MHz	20	250MHz	440mA	0.14Ω	8.0GHz
LQW04AN7N0D00□	7nH ±0.5nH	100MHz	20	250MHz	440mA	0.14Ω	8.0GHz
LQW04AN7N1C00□	7.1nH ±0.2nH	100MHz	20	250MHz	440mA	0.14Ω	8.0GHz
LQW04AN7N1D00□	7.1nH ±0.5nH	100MHz	20	250MHz	440mA	0.14Ω	8.0GHz
LQW04AN7N2C00□	7.2nH ±0.2nH	100MHz	20	250MHz	440mA	0.14Ω	8.0GHz
LQW04AN7N2D00□	7.2nH ±0.5nH	100MHz	20	250MHz	440mA	0.14Ω	8.0GHz
LQW04AN7N3C00□	7.3nH ±0.2nH	100MHz	20	250MHz	440mA	0.14Ω	8.0GHz
LQW04AN7N3D00□	7.3nH ±0.5nH	100MHz	20	250MHz	440mA	0.14Ω	8.0GHz
LQW04AN7N4C00□	7.4nH ±0.2nH	100MHz	20	250MHz	440mA	0.14Ω	8.0GHz
LQW04AN7N4D00□	7.4nH ±0.5nH	100MHz	20	250MHz	440mA	0.14Ω	8.0GHz
LQW04AN7N5C00□	7.5nH ±0.2nH	100MHz	20	250MHz	440mA	0.14Ω	8.0GHz
LQW04AN7N5D00□	7.5nH ±0.5nH	100MHz	20	250MHz	440mA	0.14Ω	8.0GHz
LQW04AN7N6C00□	7.6nH ±0.2nH	100MHz	20	250MHz	350mA	0.23Ω	8.0GHz
LQW04AN7N6D00□	7.6nH ±0.5nH	100MHz	20	250MHz	350mA	0.23Ω	8.0GHz
LQW04AN7N7C00□	7.7nH ±0.2nH	100MHz	20	250MHz	350mA	0.23Ω	8.0GHz
LQW04AN7N7D00□	7.7nH ±0.5nH	100MHz	20	250MHz	350mA	0.23Ω	8.0GHz
LQW04AN7N8C00□	7.8nH ±0.2nH	100MHz	20	250MHz	350mA	0.23Ω	8.0GHz
LQW04AN7N8D00□	7.8nH ±0.5nH	100MHz	20	250MHz	350mA	0.23Ω	8.0GHz
LQW04AN7N9C00□	7.9nH ±0.2nH	100MHz	20	250MHz	350mA	0.23Ω	8.0GHz
LQW04AN7N9D00□	7.9nH ±0.5nH	100MHz	20	250MHz	350mA	0.23Ω	8.0GHz
LQW04AN8N0C00□	8nH ±0.2nH	100MHz	20	250MHz	350mA	0.23Ω	8.0GHz
LQW04AN8N0D00□	8nH ±0.5nH	100MHz	20	250MHz	350mA	0.23Ω	8.0GHz
LQW04AN8N1C00□	8.1nH ±0.2nH	100MHz	20	250MHz	350mA	0.23Ω	8.0GHz
LQW04AN8N1D00□	8.1nH ±0.5nH	100MHz	20	250MHz	350mA	0.23Ω	8.0GHz
LQW04AN8N2C00□	8.2nH ±0.2nH	100MHz	20	250MHz	350mA	0.23Ω	8.0GHz
LQW04AN8N2D00□	8.2nH ±0.5nH	100MHz	20	250MHz	350mA	0.23Ω	8.0GHz
LQW04AN8N3C00□	8.3nH ±0.2nH	100MHz	20	250MHz	350mA	0.23Ω	8.0GHz
LQW04AN8N3D00□	8.3nH ±0.5nH	100MHz	20	250MHz	350mA	0.23Ω	8.0GHz
LQW04AN8N4C00□	8.4nH ±0.2nH	100MHz	20	250MHz	350mA	0.23Ω	8.0GHz
LQW04AN8N4D00□	8.4nH ±0.5nH	100MHz	20	250MHz	350mA	0.23Ω	8.0GHz

Operating temp. range: -55 to 125°C
 Only for reflow soldering
 *S.R.F.: Self Resonant Frequency

Continued on the following page. ↗

Continued from the preceding page. ↘

Part Number (□: packaging code)	Inductance	Inductance Test Frequency	Q (min.)	Q Test Frequency	Rated Current	Max. of DC Resistance	S.R.F.* (min.)
LQW04AN8N5C00□	8.5nH ±0.2nH	100MHz	15	250MHz	290mA	0.33Ω	7.0GHz
LQW04AN8N5D00□	8.5nH ±0.5nH	100MHz	15	250MHz	290mA	0.33Ω	7.0GHz
LQW04AN8N6C00□	8.6nH ±0.2nH	100MHz	15	250MHz	290mA	0.33Ω	7.0GHz
LQW04AN8N6D00□	8.6nH ±0.5nH	100MHz	15	250MHz	290mA	0.33Ω	7.0GHz
LQW04AN8N7C00□	8.7nH ±0.2nH	100MHz	15	250MHz	290mA	0.33Ω	7.0GHz
LQW04AN8N7D00□	8.7nH ±0.5nH	100MHz	15	250MHz	290mA	0.33Ω	7.0GHz
LQW04AN8N8C00□	8.8nH ±0.2nH	100MHz	15	250MHz	290mA	0.33Ω	7.0GHz
LQW04AN8N8D00□	8.8nH ±0.5nH	100MHz	15	250MHz	290mA	0.33Ω	7.0GHz
LQW04AN8N9C00□	8.9nH ±0.2nH	100MHz	20	250MHz	330mA	0.26Ω	7.0GHz
LQW04AN8N9D00□	8.9nH ±0.5nH	100MHz	20	250MHz	330mA	0.26Ω	7.0GHz
LQW04AN9N0C00□	9nH ±0.2nH	100MHz	20	250MHz	330mA	0.26Ω	7.0GHz
LQW04AN9N0D00□	9nH ±0.5nH	100MHz	20	250MHz	330mA	0.26Ω	7.0GHz
LQW04AN9N1C00□	9.1nH ±0.2nH	100MHz	20	250MHz	400mA	0.16Ω	7.0GHz
LQW04AN9N1D00□	9.1nH ±0.5nH	100MHz	20	250MHz	400mA	0.16Ω	7.0GHz
LQW04AN9N2C00□	9.2nH ±0.2nH	100MHz	20	250MHz	400mA	0.16Ω	7.0GHz
LQW04AN9N2D00□	9.2nH ±0.5nH	100MHz	20	250MHz	400mA	0.16Ω	7.0GHz
LQW04AN9N3C00□	9.3nH ±0.2nH	100MHz	20	250MHz	330mA	0.26Ω	7.0GHz
LQW04AN9N3D00□	9.3nH ±0.5nH	100MHz	20	250MHz	330mA	0.26Ω	7.0GHz
LQW04AN9N4C00□	9.4nH ±0.2nH	100MHz	20	250MHz	330mA	0.26Ω	7.0GHz
LQW04AN9N4D00□	9.4nH ±0.5nH	100MHz	20	250MHz	330mA	0.26Ω	7.0GHz
LQW04AN9N5C00□	9.5nH ±0.2nH	100MHz	20	250MHz	330mA	0.26Ω	7.0GHz
LQW04AN9N5D00□	9.5nH ±0.5nH	100MHz	20	250MHz	330mA	0.26Ω	7.0GHz
LQW04AN9N6C00□	9.6nH ±0.2nH	100MHz	20	250MHz	330mA	0.26Ω	7.0GHz
LQW04AN9N6D00□	9.6nH ±0.5nH	100MHz	20	250MHz	330mA	0.26Ω	7.0GHz
LQW04AN9N7C00□	9.7nH ±0.2nH	100MHz	20	250MHz	330mA	0.26Ω	7.0GHz
LQW04AN9N7D00□	9.7nH ±0.5nH	100MHz	20	250MHz	330mA	0.26Ω	7.0GHz
LQW04AN9N8C00□	9.8nH ±0.2nH	100MHz	20	250MHz	330mA	0.26Ω	7.0GHz
LQW04AN9N8D00□	9.8nH ±0.5nH	100MHz	20	250MHz	330mA	0.26Ω	7.0GHz
LQW04AN9N9C00□	9.9nH ±0.2nH	100MHz	20	250MHz	330mA	0.26Ω	7.0GHz
LQW04AN9N9D00□	9.9nH ±0.5nH	100MHz	20	250MHz	330mA	0.26Ω	7.0GHz
LQW04AN10NH00□	10nH ±3%	100MHz	20	250MHz	330mA	0.26Ω	7.0GHz
LQW04AN10NJ00□	10nH ±5%	100MHz	20	250MHz	330mA	0.26Ω	7.0GHz
LQW04AN11NH00□	11nH ±3%	100MHz	15	250MHz	310mA	0.28Ω	7.0GHz
LQW04AN11NJ00□	11nH ±5%	100MHz	15	250MHz	310mA	0.28Ω	7.0GHz
LQW04AN12NH00□	12nH ±3%	100MHz	15	250MHz	310mA	0.28Ω	6.0GHz
LQW04AN12NJ00□	12nH ±5%	100MHz	15	250MHz	310mA	0.28Ω	6.0GHz
LQW04AN13NH00□	13nH ±3%	100MHz	15	250MHz	280mA	0.34Ω	6.0GHz
LQW04AN13NJ00□	13nH ±5%	100MHz	15	250MHz	280mA	0.34Ω	6.0GHz
LQW04AN14NH00□	14nH ±3%	100MHz	15	250MHz	280mA	0.34Ω	6.0GHz
LQW04AN14NJ00□	14nH ±5%	100MHz	15	250MHz	280mA	0.34Ω	6.0GHz
LQW04AN15NH00□	15nH ±3%	100MHz	15	250MHz	240mA	0.48Ω	5.5GHz
LQW04AN15NJ00□	15nH ±5%	100MHz	15	250MHz	240mA	0.48Ω	5.5GHz
LQW04AN16NH00□	16nH ±3%	100MHz	15	250MHz	270mA	0.38Ω	5.5GHz
LQW04AN16NJ00□	16nH ±5%	100MHz	15	250MHz	270mA	0.38Ω	5.5GHz
LQW04AN18NH00□	18nH ±3%	100MHz	15	250MHz	220mA	0.54Ω	5.0GHz
LQW04AN18NJ00□	18nH ±5%	100MHz	15	250MHz	220mA	0.54Ω	5.0GHz
LQW04AN19NH00□	19nH ±3%	100MHz	15	250MHz	160mA	0.73Ω	5.0GHz
LQW04AN19NJ00□	19nH ±5%	100MHz	15	250MHz	160mA	0.73Ω	5.0GHz
LQW04AN20NH00□	20nH ±3%	100MHz	15	250MHz	210mA	0.56Ω	5.0GHz
LQW04AN20NJ00□	20nH ±5%	100MHz	15	250MHz	210mA	0.56Ω	5.0GHz
LQW04AN22NH00□	22nH ±3%	100MHz	15	250MHz	200mA	0.63Ω	5.0GHz
LQW04AN22NJ00□	22nH ±5%	100MHz	15	250MHz	200mA	0.63Ω	5.0GHz
LQW04AN23NH00□	23nH ±3%	100MHz	15	250MHz	160mA	0.95Ω	4.0GHz

Operating temp. range: -55 to 125°C
 Only for reflow soldering
 *S.R.F.: Self Resonant Frequency

Continued on the following page. ↗

Continued from the preceding page. ↘

Part Number (□: packaging code)	Inductance	Inductance Test Frequency	Q (min.)	Q Test Frequency	Rated Current	Max. of DC Resistance	S.R.F.* (min.)
LQW04AN23NJ00□	23nH ±5%	100MHz	15	250MHz	160mA	0.95Ω	4.0GHz
LQW04AN24NH00□	24nH ±3%	100MHz	15	250MHz	160mA	0.95Ω	4.0GHz
LQW04AN24NJ00□	24nH ±5%	100MHz	15	250MHz	160mA	0.95Ω	4.0GHz
LQW04AN25NH00□	25nH ±3%	100MHz	15	250MHz	160mA	0.95Ω	4.0GHz
LQW04AN25NJ00□	25nH ±5%	100MHz	15	250MHz	160mA	0.95Ω	4.0GHz
LQW04AN27NH00□	27nH ±3%	100MHz	15	250MHz	160mA	0.95Ω	4.0GHz
LQW04AN27NJ00□	27nH ±5%	100MHz	15	250MHz	160mA	0.95Ω	4.0GHz
LQW04AN33NH00□	33nH ±3%	100MHz	15	250MHz	140mA	1.11Ω	4.0GHz
LQW04AN33NJ00□	33nH ±5%	100MHz	15	250MHz	140mA	1.11Ω	4.0GHz

Operating temp. range: -55 to 125°C

Only for reflow soldering

*S.R.F.: Self Resonant Frequency

Inductance-Frequency Characteristics (Typ.)



Q-Frequency Characteristics (Typ.)



LQW04AN_10 Series 03015 (0804) inch (mm)



(in mm)

Packaging Code	Packaging	Minimum Quantity
D	ø180mm Paper Taping	10000
B	Packing in Bulk	500

Part Number (□: packaging code)	Inductance	Inductance Test Frequency	Q (min.)	Q Test Frequency	Rated Current	Max. of DC Resistance	S.R.F.* (min.)
LQW04AN36NJ10□	36nH ±5%	100MHz	18	250MHz	200mA	1.08Ω	2.1GHz
LQW04AN39NJ10□	39nH ±5%	100MHz	16	250MHz	200mA	1.08Ω	1.2GHz
LQW04AN43NJ10□	43nH ±5%	100MHz	15	250MHz	180mA	1.2Ω	1.6GHz
LQW04AN47NJ10□	47nH ±5%	100MHz	16	250MHz	180mA	1.2Ω	1.6GHz
LQW04AN52NJ10□	52nH ±5%	100MHz	15	250MHz	180mA	1.32Ω	1.4GHz
LQW04AN56NJ10□	56nH ±5%	100MHz	13	250MHz	180mA	1.32Ω	1.2GHz

Operating temp. range: -55 to 125°C

Only for reflow soldering

*S.R.F.: Self Resonant Frequency

Continued on the following page. ↗

Continued from the preceding page. ↘

Inductance-Frequency Characteristics (Typ.)



Q-Frequency Characteristics (Typ.)



LQW15AN_00 Series 0402 (1005) inch (mm)



Packaging Code	Packaging	Minimum Quantity
D	ø180mm Paper Taping	10000
B	Packing in Bulk	500

(in mm)

Part Number (□: packaging code)	Inductance	Inductance Test Frequency	Q (min.)	Q Test Frequency	Rated Current	Max. of DC Resistance	S.R.F.* (min.)
LQW15AN1N5B00□	1.5nH ±0.1nH	100MHz	10	250MHz	1000mA	0.03Ω	18.0GHz
LQW15AN1N5C00□	1.5nH ±0.2nH	100MHz	10	250MHz	1000mA	0.03Ω	18.0GHz
LQW15AN1N5D00□	1.5nH ±0.5nH	100MHz	10	250MHz	1000mA	0.03Ω	18.0GHz
LQW15AN1N6C00□	1.6nH ±0.2nH	100MHz	10	250MHz	750mA	0.07Ω	17.0GHz
LQW15AN1N6D00□	1.6nH ±0.5nH	100MHz	10	250MHz	750mA	0.07Ω	17.0GHz
LQW15AN1N7C00□	1.7nH ±0.2nH	100MHz	10	250MHz	640mA	0.10Ω	17.0GHz
LQW15AN1N7D00□	1.7nH ±0.5nH	100MHz	10	250MHz	640mA	0.10Ω	17.0GHz
LQW15AN1N8C00□	1.8nH ±0.2nH	100MHz	10	250MHz	460mA	0.16Ω	16.0GHz
LQW15AN1N8D00□	1.8nH ±0.5nH	100MHz	10	250MHz	460mA	0.16Ω	16.0GHz
LQW15AN2N4B00□	2.4nH ±0.1nH	100MHz	20	250MHz	850mA	0.05Ω	15.0GHz
LQW15AN2N4C00□	2.4nH ±0.2nH	100MHz	20	250MHz	850mA	0.05Ω	15.0GHz
LQW15AN2N4D00□	2.4nH ±0.5nH	100MHz	20	250MHz	850mA	0.05Ω	15.0GHz
LQW15AN2N5B00□	2.5nH ±0.1nH	100MHz	20	250MHz	850mA	0.05Ω	15.0GHz
LQW15AN2N5C00□	2.5nH ±0.2nH	100MHz	20	250MHz	850mA	0.05Ω	15.0GHz
LQW15AN2N5D00□	2.5nH ±0.5nH	100MHz	20	250MHz	850mA	0.05Ω	15.0GHz
LQW15AN2N6B00□	2.6nH ±0.1nH	100MHz	20	250MHz	850mA	0.05Ω	15.0GHz
LQW15AN2N6C00□	2.6nH ±0.2nH	100MHz	20	250MHz	850mA	0.05Ω	15.0GHz
LQW15AN2N6D00□	2.6nH ±0.5nH	100MHz	20	250MHz	850mA	0.05Ω	15.0GHz
LQW15AN2N7B00□	2.7nH ±0.1nH	100MHz	20	250MHz	850mA	0.05Ω	15.0GHz
LQW15AN2N7C00□	2.7nH ±0.2nH	100MHz	20	250MHz	850mA	0.05Ω	15.0GHz
LQW15AN2N7D00□	2.7nH ±0.5nH	100MHz	20	250MHz	850mA	0.05Ω	15.0GHz
LQW15AN2N8B00□	2.8nH ±0.1nH	100MHz	20	250MHz	850mA	0.05Ω	15.0GHz
LQW15AN2N8C00□	2.8nH ±0.2nH	100MHz	20	250MHz	850mA	0.05Ω	15.0GHz
LQW15AN2N8D00□	2.8nH ±0.5nH	100MHz	20	250MHz	850mA	0.05Ω	15.0GHz
LQW15AN2N9B00□	2.9nH ±0.1nH	100MHz	20	250MHz	750mA	0.07Ω	15.0GHz
LQW15AN2N9C00□	2.9nH ±0.2nH	100MHz	20	250MHz	750mA	0.07Ω	15.0GHz

Operating temp. range: -55 to 125°C

Only for reflow soldering

*S.R.F.: Self Resonant Frequency

Continued on the following page. ↗

Continued from the preceding page. ↘

Part Number (□: packaging code)	Inductance	Inductance Test Frequency	Q (min.)	Q Test Frequency	Rated Current	Max. of DC Resistance	S.R.F.* (min.)
LQW15AN2N9D00□	2.9nH ±0.5nH	100MHz	20	250MHz	750mA	0.07Ω	15.0GHz
LQW15AN3NOB00□	3.0nH ±0.1nH	100MHz	20	250MHz	750mA	0.07Ω	15.0GHz
LQW15AN3NOC00□	3.0nH ±0.2nH	100MHz	20	250MHz	750mA	0.07Ω	15.0GHz
LQW15AN3NOD00□	3.0nH ±0.5nH	100MHz	20	250MHz	750mA	0.07Ω	15.0GHz
LQW15AN3N1B00□	3.1nH ±0.1nH	100MHz	20	250MHz	570mA	0.13Ω	14.0GHz
LQW15AN3N1C00□	3.1nH ±0.2nH	100MHz	20	250MHz	570mA	0.13Ω	14.0GHz
LQW15AN3N1D00□	3.1nH ±0.5nH	100MHz	20	250MHz	570mA	0.13Ω	14.0GHz
LQW15AN3N2B00□	3.2nH ±0.1nH	100MHz	15	250MHz	500mA	0.17Ω	14.0GHz
LQW15AN3N2C00□	3.2nH ±0.2nH	100MHz	15	250MHz	500mA	0.17Ω	14.0GHz
LQW15AN3N2D00□	3.2nH ±0.5nH	100MHz	15	250MHz	500mA	0.17Ω	14.0GHz
LQW15AN3N9B00□	3.9nH ±0.1nH	100MHz	25	250MHz	750mA	0.07Ω	10.0GHz
LQW15AN3N9C00□	3.9nH ±0.2nH	100MHz	25	250MHz	750mA	0.07Ω	10.0GHz
LQW15AN3N9D00□	3.9nH ±0.5nH	100MHz	25	250MHz	750mA	0.07Ω	10.0GHz
LQW15AN4N1B00□	4.1nH ±0.1nH	100MHz	25	250MHz	750mA	0.07Ω	10.0GHz
LQW15AN4N1C00□	4.1nH ±0.2nH	100MHz	25	250MHz	750mA	0.07Ω	10.0GHz
LQW15AN4N1D00□	4.1nH ±0.5nH	100MHz	25	250MHz	750mA	0.07Ω	10.0GHz
LQW15AN4N3B00□	4.3nH ±0.1nH	100MHz	25	250MHz	750mA	0.07Ω	10.0GHz
LQW15AN4N3C00□	4.3nH ±0.2nH	100MHz	25	250MHz	750mA	0.07Ω	10.0GHz
LQW15AN4N3D00□	4.3nH ±0.5nH	100MHz	25	250MHz	750mA	0.07Ω	10.0GHz
LQW15AN4N4B00□	4.4nH ±0.1nH	100MHz	25	250MHz	750mA	0.07Ω	8.0GHz
LQW15AN4N4C00□	4.4nH ±0.2nH	100MHz	25	250MHz	750mA	0.07Ω	8.0GHz
LQW15AN4N4D00□	4.4nH ±0.5nH	100MHz	25	250MHz	750mA	0.07Ω	8.0GHz
LQW15AN4N5B00□	4.5nH ±0.1nH	100MHz	25	250MHz	750mA	0.07Ω	8.0GHz
LQW15AN4N5C00□	4.5nH ±0.2nH	100MHz	25	250MHz	750mA	0.07Ω	8.0GHz
LQW15AN4N5D00□	4.5nH ±0.5nH	100MHz	25	250MHz	750mA	0.07Ω	8.0GHz
LQW15AN4N6B00□	4.6nH ±0.1nH	100MHz	25	250MHz	750mA	0.07Ω	8.0GHz
LQW15AN4N6C00□	4.6nH ±0.2nH	100MHz	25	250MHz	750mA	0.07Ω	8.0GHz
LQW15AN4N6D00□	4.6nH ±0.5nH	100MHz	25	250MHz	750mA	0.07Ω	8.0GHz
LQW15AN4N7B00□	4.7nH ±0.1nH	100MHz	25	250MHz	750mA	0.07Ω	8.0GHz
LQW15AN4N7C00□	4.7nH ±0.2nH	100MHz	25	250MHz	750mA	0.07Ω	8.0GHz
LQW15AN4N7D00□	4.7nH ±0.5nH	100MHz	25	250MHz	750mA	0.07Ω	8.0GHz
LQW15AN4N8B00□	4.8nH ±0.1nH	100MHz	25	250MHz	750mA	0.07Ω	8.0GHz
LQW15AN4N8C00□	4.8nH ±0.2nH	100MHz	25	250MHz	750mA	0.07Ω	8.0GHz
LQW15AN4N8D00□	4.8nH ±0.5nH	100MHz	25	250MHz	750mA	0.07Ω	8.0GHz
LQW15AN4N9B00□	4.9nH ±0.1nH	100MHz	25	250MHz	600mA	0.12Ω	8.0GHz
LQW15AN4N9C00□	4.9nH ±0.2nH	100MHz	25	250MHz	600mA	0.12Ω	8.0GHz
LQW15AN4N9D00□	4.9nH ±0.5nH	100MHz	25	250MHz	600mA	0.12Ω	8.0GHz
LQW15AN5NOB00□	5.0nH ±0.1nH	100MHz	25	250MHz	600mA	0.12Ω	8.0GHz
LQW15AN5NOC00□	5.0nH ±0.2nH	100MHz	25	250MHz	600mA	0.12Ω	8.0GHz
LQW15AN5NOD00□	5.0nH ±0.5nH	100MHz	25	250MHz	600mA	0.12Ω	8.0GHz
LQW15AN5N1B00□	5.1nH ±0.1nH	100MHz	25	250MHz	600mA	0.12Ω	8.0GHz
LQW15AN5N1C00□	5.1nH ±0.2nH	100MHz	25	250MHz	600mA	0.12Ω	8.0GHz
LQW15AN5N1D00□	5.1nH ±0.5nH	100MHz	25	250MHz	600mA	0.12Ω	8.0GHz
LQW15AN5N8B00□	5.8nH ±0.1nH	100MHz	25	250MHz	700mA	0.09Ω	8.0GHz
LQW15AN5N8C00□	5.8nH ±0.2nH	100MHz	25	250MHz	700mA	0.09Ω	8.0GHz
LQW15AN5N8D00□	5.8nH ±0.5nH	100MHz	25	250MHz	700mA	0.09Ω	8.0GHz
LQW15AN6N2B00□	6.2nH ±0.1nH	100MHz	25	250MHz	700mA	0.09Ω	8.0GHz
LQW15AN6N2C00□	6.2nH ±0.2nH	100MHz	25	250MHz	700mA	0.09Ω	8.0GHz
LQW15AN6N2D00□	6.2nH ±0.5nH	100MHz	25	250MHz	700mA	0.09Ω	8.0GHz
LQW15AN6N3B00□	6.3nH ±0.1nH	100MHz	25	250MHz	700mA	0.09Ω	6.0GHz
LQW15AN6N3C00□	6.3nH ±0.2nH	100MHz	25	250MHz	700mA	0.09Ω	6.0GHz
LQW15AN6N3D00□	6.3nH ±0.5nH	100MHz	25	250MHz	700mA	0.09Ω	6.0GHz
LQW15AN6N4B00□	6.4nH ±0.1nH	100MHz	25	250MHz	700mA	0.09Ω	6.0GHz

Operating temp. range: -55 to 125°C
 Only for reflow soldering
 *S.R.F.: Self Resonant Frequency

Continued on the following page. ↗

Continued from the preceding page. ↘

Part Number (□: packaging code)	Inductance	Inductance Test Frequency	Q (min.)	Q Test Frequency	Rated Current	Max. of DC Resistance	S.R.F.* (min.)
LQW15AN6N4C00□	6.4nH ±0.2nH	100MHz	25	250MHz	700mA	0.09Ω	6.0GHz
LQW15AN6N4D00□	6.4nH ±0.5nH	100MHz	25	250MHz	700mA	0.09Ω	6.0GHz
LQW15AN6N5B00□	6.5nH ±0.1nH	100MHz	25	250MHz	700mA	0.09Ω	6.0GHz
LQW15AN6N5C00□	6.5nH ±0.2nH	100MHz	25	250MHz	700mA	0.09Ω	6.0GHz
LQW15AN6N5D00□	6.5nH ±0.5nH	100MHz	25	250MHz	700mA	0.09Ω	6.0GHz
LQW15AN6N6B00□	6.6nH ±0.1nH	100MHz	25	250MHz	700mA	0.09Ω	6.0GHz
LQW15AN6N6C00□	6.6nH ±0.2nH	100MHz	25	250MHz	700mA	0.09Ω	6.0GHz
LQW15AN6N6D00□	6.6nH ±0.5nH	100MHz	25	250MHz	700mA	0.09Ω	6.0GHz
LQW15AN6N7B00□	6.7nH ±0.1nH	100MHz	25	250MHz	700mA	0.09Ω	6.0GHz
LQW15AN6N7C00□	6.7nH ±0.2nH	100MHz	25	250MHz	700mA	0.09Ω	6.0GHz
LQW15AN6N7D00□	6.7nH ±0.5nH	100MHz	25	250MHz	700mA	0.09Ω	6.0GHz
LQW15AN6N8G00□	6.8nH ±2%	100MHz	25	250MHz	700mA	0.09Ω	6.0GHz
LQW15AN6N8H00□	6.8nH ±3%	100MHz	25	250MHz	700mA	0.09Ω	6.0GHz
LQW15AN6N8J00□	6.8nH ±5%	100MHz	25	250MHz	700mA	0.09Ω	6.0GHz
LQW15AN6N9G00□	6.9nH ±2%	100MHz	25	250MHz	570mA	0.13Ω	6.0GHz
LQW15AN6N9H00□	6.9nH ±3%	100MHz	25	250MHz	570mA	0.13Ω	6.0GHz
LQW15AN6N9J00□	6.9nH ±5%	100MHz	25	250MHz	570mA	0.13Ω	6.0GHz
LQW15AN7N0G00□	7.0nH ±2%	100MHz	25	250MHz	570mA	0.13Ω	6.0GHz
LQW15AN7N0H00□	7.0nH ±3%	100MHz	25	250MHz	570mA	0.13Ω	6.0GHz
LQW15AN7N0J00□	7.0nH ±5%	100MHz	25	250MHz	570mA	0.13Ω	6.0GHz
LQW15AN7N1G00□	7.1nH ±2%	100MHz	25	250MHz	570mA	0.13Ω	6.0GHz
LQW15AN7N1H00□	7.1nH ±3%	100MHz	25	250MHz	570mA	0.13Ω	6.0GHz
LQW15AN7N1J00□	7.1nH ±5%	100MHz	25	250MHz	570mA	0.13Ω	6.0GHz
LQW15AN7N2G00□	7.2nH ±2%	100MHz	25	250MHz	570mA	0.13Ω	6.0GHz
LQW15AN7N2H00□	7.2nH ±3%	100MHz	25	250MHz	570mA	0.13Ω	6.0GHz
LQW15AN7N2J00□	7.2nH ±5%	100MHz	25	250MHz	570mA	0.13Ω	6.0GHz
LQW15AN7N3G00□	7.3nH ±2%	100MHz	25	250MHz	570mA	0.13Ω	6.0GHz
LQW15AN7N3H00□	7.3nH ±3%	100MHz	25	250MHz	570mA	0.13Ω	6.0GHz
LQW15AN7N3J00□	7.3nH ±5%	100MHz	25	250MHz	570mA	0.13Ω	6.0GHz
LQW15AN7N5G00□	7.5nH ±2%	100MHz	25	250MHz	570mA	0.13Ω	6.0GHz
LQW15AN7N5H00□	7.5nH ±3%	100MHz	25	250MHz	570mA	0.13Ω	6.0GHz
LQW15AN7N5J00□	7.5nH ±5%	100MHz	25	250MHz	570mA	0.13Ω	6.0GHz
LQW15AN8N2G00□	8.2nH ±2%	100MHz	25	250MHz	540mA	0.14Ω	5.5GHz
LQW15AN8N2H00□	8.2nH ±3%	100MHz	25	250MHz	540mA	0.14Ω	5.5GHz
LQW15AN8N2J00□	8.2nH ±5%	100MHz	25	250MHz	540mA	0.14Ω	5.5GHz
LQW15AN8N6G00□	8.6nH ±2%	100MHz	25	250MHz	540mA	0.14Ω	5.5GHz
LQW15AN8N6H00□	8.6nH ±3%	100MHz	25	250MHz	540mA	0.14Ω	5.5GHz
LQW15AN8N6J00□	8.6nH ±5%	100MHz	25	250MHz	540mA	0.14Ω	5.5GHz
LQW15AN8N7G00□	8.7nH ±2%	100MHz	25	250MHz	540mA	0.14Ω	5.5GHz
LQW15AN8N7H00□	8.7nH ±3%	100MHz	25	250MHz	540mA	0.14Ω	5.5GHz
LQW15AN8N7J00□	8.7nH ±5%	100MHz	25	250MHz	540mA	0.14Ω	5.5GHz
LQW15AN8N8G00□	8.8nH ±2%	100MHz	25	250MHz	540mA	0.14Ω	5.5GHz
LQW15AN8N8H00□	8.8nH ±3%	100MHz	25	250MHz	540mA	0.14Ω	5.5GHz
LQW15AN8N8J00□	8.8nH ±5%	100MHz	25	250MHz	540mA	0.14Ω	5.5GHz
LQW15AN8N9G00□	8.9nH ±2%	100MHz	25	250MHz	540mA	0.14Ω	5.5GHz
LQW15AN8N9H00□	8.9nH ±3%	100MHz	25	250MHz	540mA	0.14Ω	5.5GHz
LQW15AN8N9J00□	8.9nH ±5%	100MHz	25	250MHz	540mA	0.14Ω	5.5GHz
LQW15AN9N0G00□	9.0nH ±2%	100MHz	25	250MHz	540mA	0.14Ω	5.5GHz
LQW15AN9N0H00□	9.0nH ±3%	100MHz	25	250MHz	540mA	0.14Ω	5.5GHz
LQW15AN9N0J00□	9.0nH ±5%	100MHz	25	250MHz	540mA	0.14Ω	5.5GHz
LQW15AN9N1G00□	9.1nH ±2%	100MHz	25	250MHz	540mA	0.14Ω	5.5GHz
LQW15AN9N1H00□	9.1nH ±3%	100MHz	25	250MHz	540mA	0.14Ω	5.5GHz
LQW15AN9N1J00□	9.1nH ±5%	100MHz	25	250MHz	540mA	0.14Ω	5.5GHz

Operating temp. range: -55 to 125°C
 Only for reflow soldering
 *S.R.F.: Self Resonant Frequency

Continued on the following page. ↗

Continued from the preceding page. ↘

Part Number (□: packaging code)	Inductance	Inductance Test Frequency	Q (min.)	Q Test Frequency	Rated Current	Max. of DC Resistance	S.R.F.* (min.)
LQW15AN9N2G00□	9.2nH ±2%	100MHz	25	250MHz	540mA	0.14Ω	5.5GHz
LQW15AN9N2H00□	9.2nH ±3%	100MHz	25	250MHz	540mA	0.14Ω	5.5GHz
LQW15AN9N2J00□	9.2nH ±5%	100MHz	25	250MHz	540mA	0.14Ω	5.5GHz
LQW15AN9N3G00□	9.3nH ±2%	100MHz	25	250MHz	540mA	0.14Ω	5.5GHz
LQW15AN9N3H00□	9.3nH ±3%	100MHz	25	250MHz	540mA	0.14Ω	5.5GHz
LQW15AN9N3J00□	9.3nH ±5%	100MHz	25	250MHz	540mA	0.14Ω	5.5GHz
LQW15AN9N4G00□	9.4nH ±2%	100MHz	25	250MHz	540mA	0.14Ω	5.5GHz
LQW15AN9N4H00□	9.4nH ±3%	100MHz	25	250MHz	540mA	0.14Ω	5.5GHz
LQW15AN9N4J00□	9.4nH ±5%	100MHz	25	250MHz	540mA	0.14Ω	5.5GHz
LQW15AN9N5G00□	9.5nH ±2%	100MHz	25	250MHz	540mA	0.14Ω	5.5GHz
LQW15AN9N5H00□	9.5nH ±3%	100MHz	25	250MHz	540mA	0.14Ω	5.5GHz
LQW15AN9N5J00□	9.5nH ±5%	100MHz	25	250MHz	540mA	0.14Ω	5.5GHz
LQW15AN9N6G00□	9.6nH ±2%	100MHz	25	250MHz	540mA	0.14Ω	5.5GHz
LQW15AN9N6H00□	9.6nH ±3%	100MHz	25	250MHz	540mA	0.14Ω	5.5GHz
LQW15AN9N6J00□	9.6nH ±5%	100MHz	25	250MHz	540mA	0.14Ω	5.5GHz
LQW15AN9N7G00□	9.7nH ±2%	100MHz	25	250MHz	540mA	0.14Ω	5.5GHz
LQW15AN9N7H00□	9.7nH ±3%	100MHz	25	250MHz	540mA	0.14Ω	5.5GHz
LQW15AN9N7J00□	9.7nH ±5%	100MHz	25	250MHz	540mA	0.14Ω	5.5GHz
LQW15AN9N8G00□	9.8nH ±2%	100MHz	25	250MHz	540mA	0.14Ω	5.5GHz
LQW15AN9N8H00□	9.8nH ±3%	100MHz	25	250MHz	540mA	0.14Ω	5.5GHz
LQW15AN9N8J00□	9.8nH ±5%	100MHz	25	250MHz	540mA	0.14Ω	5.5GHz
LQW15AN9N9G00□	9.9nH ±2%	100MHz	25	250MHz	540mA	0.14Ω	5.5GHz
LQW15AN9N9H00□	9.9nH ±3%	100MHz	25	250MHz	540mA	0.14Ω	5.5GHz
LQW15AN9N9J00□	9.9nH ±5%	100MHz	25	250MHz	540mA	0.14Ω	5.5GHz
LQW15AN10NG00□	10nH ±2%	100MHz	25	250MHz	500mA	0.17Ω	5.5GHz
LQW15AN10NH00□	10nH ±3%	100MHz	25	250MHz	500mA	0.17Ω	5.5GHz
LQW15AN10NJ00□	10nH ±5%	100MHz	25	250MHz	500mA	0.17Ω	5.5GHz
LQW15AN11NG00□	11nH ±2%	100MHz	30	250MHz	500mA	0.14Ω	5.5GHz
LQW15AN11NH00□	11nH ±3%	100MHz	30	250MHz	500mA	0.14Ω	5.5GHz
LQW15AN11NJ00□	11nH ±5%	100MHz	30	250MHz	500mA	0.14Ω	5.5GHz
LQW15AN12NG00□	12nH ±2%	100MHz	30	250MHz	500mA	0.14Ω	5.5GHz
LQW15AN12NH00□	12nH ±3%	100MHz	30	250MHz	500mA	0.14Ω	5.5GHz
LQW15AN12NJ00□	12nH ±5%	100MHz	30	250MHz	500mA	0.14Ω	5.5GHz
LQW15AN13NG00□	13nH ±2%	100MHz	25	250MHz	430mA	0.21Ω	5.0GHz
LQW15AN13NH00□	13nH ±3%	100MHz	25	250MHz	430mA	0.21Ω	5.0GHz
LQW15AN13NJ00□	13nH ±5%	100MHz	25	250MHz	430mA	0.21Ω	5.0GHz
LQW15AN15NG00□	15nH ±2%	100MHz	30	250MHz	460mA	0.16Ω	5.0GHz
LQW15AN15NH00□	15nH ±3%	100MHz	30	250MHz	460mA	0.16Ω	5.0GHz
LQW15AN15NJ00□	15nH ±5%	100MHz	30	250MHz	460mA	0.16Ω	5.0GHz
LQW15AN16NG00□	16nH ±2%	100MHz	25	250MHz	370mA	0.24Ω	4.5GHz
LQW15AN16NH00□	16nH ±3%	100MHz	25	250MHz	370mA	0.24Ω	4.5GHz
LQW15AN16NJ00□	16nH ±5%	100MHz	25	250MHz	370mA	0.24Ω	4.5GHz
LQW15AN18NG00□	18nH ±2%	100MHz	25	250MHz	370mA	0.27Ω	4.5GHz
LQW15AN18NH00□	18nH ±3%	100MHz	25	250MHz	370mA	0.27Ω	4.5GHz
LQW15AN18NJ00□	18nH ±5%	100MHz	25	250MHz	370mA	0.27Ω	4.5GHz
LQW15AN19NG00□	19nH ±2%	100MHz	25	250MHz	370mA	0.27Ω	4.5GHz
LQW15AN19NH00□	19nH ±3%	100MHz	25	250MHz	370mA	0.27Ω	4.5GHz
LQW15AN19NJ00□	19nH ±5%	100MHz	25	250MHz	370mA	0.27Ω	4.5GHz
LQW15AN20NG00□	20nH ±2%	100MHz	25	250MHz	370mA	0.27Ω	4.0GHz
LQW15AN20NH00□	20nH ±3%	100MHz	25	250MHz	370mA	0.27Ω	4.0GHz
LQW15AN20NJ00□	20nH ±5%	100MHz	25	250MHz	370mA	0.27Ω	4.0GHz
LQW15AN22NG00□	22nH ±2%	100MHz	25	250MHz	310mA	0.30Ω	4.0GHz
LQW15AN22NH00□	22nH ±3%	100MHz	25	250MHz	310mA	0.30Ω	4.0GHz

Operating temp. range: -55 to 125°C
 Only for reflow soldering
 *S.R.F.: Self Resonant Frequency

Continued on the following page. ↗

Continued from the preceding page. ↘

Part Number (□: packaging code)	Inductance	Inductance Test Frequency	Q (min.)	Q Test Frequency	Rated Current	Max. of DC Resistance	S.R.F.* (min.)
LQW15AN22NJ00□	22nH ±5%	100MHz	25	250MHz	310mA	0.30Ω	4.0GHz
LQW15AN23NG00□	23nH ±2%	100MHz	25	250MHz	310mA	0.30Ω	3.8GHz
LQW15AN23NH00□	23nH ±3%	100MHz	25	250MHz	310mA	0.30Ω	3.8GHz
LQW15AN23NJ00□	23nH ±5%	100MHz	25	250MHz	310mA	0.30Ω	3.8GHz
LQW15AN24NG00□	24nH ±2%	100MHz	25	250MHz	280mA	0.52Ω	3.5GHz
LQW15AN24NH00□	24nH ±3%	100MHz	25	250MHz	280mA	0.52Ω	3.5GHz
LQW15AN24NJ00□	24nH ±5%	100MHz	25	250MHz	280mA	0.52Ω	3.5GHz
LQW15AN27NG00□	27nH ±2%	100MHz	25	250MHz	280mA	0.52Ω	3.5GHz
LQW15AN27NH00□	27nH ±3%	100MHz	25	250MHz	280mA	0.52Ω	3.5GHz
LQW15AN27NJ00□	27nH ±5%	100MHz	25	250MHz	280mA	0.52Ω	3.5GHz
LQW15AN30NG00□	30nH ±2%	100MHz	25	250MHz	270mA	0.58Ω	3.3GHz
LQW15AN30NH00□	30nH ±3%	100MHz	25	250MHz	270mA	0.58Ω	3.3GHz
LQW15AN30NJ00□	30nH ±5%	100MHz	25	250MHz	270mA	0.58Ω	3.3GHz
LQW15AN33NG00□	33nH ±2%	100MHz	25	250MHz	260mA	0.63Ω	3.2GHz
LQW15AN33NH00□	33nH ±3%	100MHz	25	250MHz	260mA	0.63Ω	3.2GHz
LQW15AN33NJ00□	33nH ±5%	100MHz	25	250MHz	260mA	0.63Ω	3.2GHz
LQW15AN36NG00□	36nH ±2%	100MHz	25	250MHz	260mA	0.63Ω	3.1GHz
LQW15AN36NH00□	36nH ±3%	100MHz	25	250MHz	260mA	0.63Ω	3.1GHz
LQW15AN36NJ00□	36nH ±5%	100MHz	25	250MHz	260mA	0.63Ω	3.1GHz
LQW15AN39NG00□	39nH ±2%	100MHz	25	250MHz	250mA	0.70Ω	3.0GHz
LQW15AN39NH00□	39nH ±3%	100MHz	25	250MHz	250mA	0.70Ω	3.0GHz
LQW15AN39NJ00□	39nH ±5%	100MHz	25	250MHz	250mA	0.70Ω	3.0GHz
LQW15AN40NG00□	40nH ±2%	100MHz	25	250MHz	250mA	0.70Ω	3.0GHz
LQW15AN40NH00□	40nH ±3%	100MHz	25	250MHz	250mA	0.70Ω	3.0GHz
LQW15AN40NJ00□	40nH ±5%	100MHz	25	250MHz	250mA	0.70Ω	3.0GHz
LQW15AN43NG00□	43nH ±2%	100MHz	25	250MHz	250mA	0.70Ω	3.0GHz
LQW15AN43NH00□	43nH ±3%	100MHz	25	250MHz	250mA	0.70Ω	3.0GHz
LQW15AN43NJ00□	43nH ±5%	100MHz	25	250MHz	250mA	0.70Ω	3.0GHz
LQW15AN47NG00□	47nH ±2%	100MHz	25	200MHz	210mA	1.08Ω	2.9GHz
LQW15AN47NH00□	47nH ±3%	100MHz	25	200MHz	210mA	1.08Ω	2.9GHz
LQW15AN47NJ00□	47nH ±5%	100MHz	25	200MHz	210mA	1.08Ω	2.9GHz
LQW15AN51NG00□	51nH ±2%	100MHz	25	200MHz	210mA	1.08Ω	2.85GHz
LQW15AN51NH00□	51nH ±3%	100MHz	25	200MHz	210mA	1.08Ω	2.85GHz
LQW15AN51NJ00□	51nH ±5%	100MHz	25	200MHz	210mA	1.08Ω	2.85GHz
LQW15AN56NG00□	56nH ±2%	100MHz	25	200MHz	200mA	1.17Ω	2.8GHz
LQW15AN56NH00□	56nH ±3%	100MHz	25	200MHz	200mA	1.17Ω	2.8GHz
LQW15AN56NJ00□	56nH ±5%	100MHz	25	200MHz	200mA	1.17Ω	2.8GHz
LQW15AN62NG00□	62nH ±2%	100MHz	20	200MHz	145mA	1.82Ω	2.6GHz
LQW15AN62NH00□	62nH ±3%	100MHz	20	200MHz	145mA	1.82Ω	2.6GHz
LQW15AN62NJ00□	62nH ±5%	100MHz	20	200MHz	145mA	1.82Ω	2.6GHz
LQW15AN68NG00□	68nH ±2%	100MHz	20	200MHz	140mA	1.96Ω	2.5GHz
LQW15AN68NJ00□	68nH ±5%	100MHz	20	200MHz	140mA	1.96Ω	2.5GHz
LQW15AN72NG00□	72nH ±2%	100MHz	20	150MHz	135mA	2.10Ω	2.5GHz
LQW15AN72NJ00□	72nH ±5%	100MHz	20	150MHz	135mA	2.10Ω	2.5GHz
LQW15AN75NG00□	75nH ±2%	100MHz	20	150MHz	135mA	2.10Ω	2.4GHz
LQW15AN75NJ00□	75nH ±5%	100MHz	20	150MHz	135mA	2.10Ω	2.4GHz
LQW15AN82NG00□	82nH ±2%	100MHz	20	150MHz	130mA	2.24Ω	2.3GHz
LQW15AN82NJ00□	82nH ±5%	100MHz	20	150MHz	130mA	2.24Ω	2.3GHz
LQW15AN91NG00□	91nH ±2%	100MHz	20	150MHz	125mA	2.38Ω	2.1GHz
LQW15AN91NJ00□	91nH ±5%	100MHz	20	150MHz	125mA	2.38Ω	2.1GHz
LQW15ANR10J00□	100nH ±5%	100MHz	20	150MHz	120mA	2.52Ω	1.5GHz
LQW15ANR12J00□	120nH ±5%	100MHz	20	150MHz	110mA	2.66Ω	1.0GHz

Operating temp. range: -55 to 125°C

Only for reflow soldering

*S.R.F.: Self Resonant Frequency

Continued on the following page. ↗

Inductors for Power Lines

Inductors for General Circuits

LQW15AN_00
RF Inductors

Continued from the preceding page. ↘

Inductance-Frequency Characteristics (Typ.)



Q-Frequency Characteristics (Typ.)



LQW15AN_10 Series 0402 (1005) inch (mm)



(in mm)

Packaging Code	Packaging	Minimum Quantity
D	ø180mm Paper Taping	10000
B	Packing in Bulk	500

Part Number (□: packaging code)	Inductance	Inductance Test Frequency	Q (min.)	Q Test Frequency	Rated Current	Max. of DC Resistance	S.R.F.* (min.)
LQW15AN1N3C10□	1.3nH ±0.2nH	100MHz	20	250MHz	1200mA	0.017Ω	16GHz
LQW15AN1N3D10□	1.3nH ±0.5nH	100MHz	20	250MHz	1200mA	0.017Ω	16GHz
LQW15AN1N4C10□	1.4nH ±0.2nH	100MHz	25	250MHz	1100mA	0.019Ω	15GHz
LQW15AN1N4D10□	1.4nH ±0.5nH	100MHz	25	250MHz	1100mA	0.019Ω	15GHz
LQW15AN2N2C10□	2.2nH ±0.2nH	100MHz	25	250MHz	1000mA	0.027Ω	14GHz
LQW15AN2N2D10□	2.2nH ±0.5nH	100MHz	25	250MHz	1000mA	0.027Ω	14GHz
LQW15AN2N3C10□	2.3nH ±0.2nH	100MHz	25	250MHz	1000mA	0.027Ω	14GHz
LQW15AN2N3D10□	2.3nH ±0.5nH	100MHz	25	250MHz	1000mA	0.027Ω	14GHz
LQW15AN2N4D10□	2.4nH ±0.5nH	100MHz	25	250MHz	1000mA	0.027Ω	14GHz
LQW15AN3N3D10□	3.3nH ±0.5nH	100MHz	30	250MHz	900mA	0.040Ω	12GHz
LQW15AN3N4C10□	3.4nH ±0.2nH	100MHz	30	250MHz	900mA	0.040Ω	12GHz
LQW15AN3N4D10□	3.4nH ±0.5nH	100MHz	30	250MHz	900mA	0.040Ω	12GHz
LQW15AN3N5C10□	3.5nH ±0.2nH	100MHz	30	250MHz	900mA	0.040Ω	9.5GHz
LQW15AN3N5D10□	3.5nH ±0.5nH	100MHz	30	250MHz	900mA	0.040Ω	9.5GHz
LQW15AN3N6C10□	3.6nH ±0.2nH	100MHz	30	250MHz	900mA	0.040Ω	9.5GHz
LQW15AN3N6D10□	3.6nH ±0.5nH	100MHz	30	250MHz	900mA	0.040Ω	9.5GHz
LQW15AN3N8C10□	3.8nH ±0.2nH	100MHz	30	250MHz	900mA	0.040Ω	7GHz
LQW15AN3N8D10□	3.8nH ±0.5nH	100MHz	30	250MHz	900mA	0.040Ω	7GHz
LQW15AN3N9D10□	3.9nH ±0.5nH	100MHz	30	250MHz	900mA	0.040Ω	7GHz
LQW15AN4N0C10□	4.0nH ±0.2nH	100MHz	30	250MHz	800mA	0.051Ω	6.5GHz
LQW15AN4N0D10□	4.0nH ±0.5nH	100MHz	30	250MHz	800mA	0.051Ω	6.5GHz
LQW15AN4N2C10□	4.2nH ±0.2nH	100MHz	30	250MHz	800mA	0.051Ω	6.5GHz
LQW15AN4N2D10□	4.2nH ±0.5nH	100MHz	30	250MHz	800mA	0.051Ω	6.5GHz
LQW15AN4N7D10□	4.7nH ±0.5nH	100MHz	30	250MHz	800mA	0.051Ω	8GHz
LQW15AN5N1C10□	5.1nH ±0.2nH	100MHz	30	250MHz	800mA	0.051Ω	8GHz
LQW15AN5N1D10□	5.1nH ±0.5nH	100MHz	30	250MHz	800mA	0.051Ω	8GHz

Operating temp. range: -55 to 125°C

Only for reflow soldering

*S.R.F.: Self Resonant Frequency

Continued from the preceding page. ↘

Part Number (□: packaging code)	Inductance	Inductance Test Frequency	Q (min.)	Q Test Frequency	Rated Current	Max. of DC Resistance	S.R.F.* (min.)
LQW15AN5N2C10□	5.2nH ±0.2nH	100MHz	30	250MHz	800mA	0.051Ω	8GHz
LQW15AN5N2D10□	5.2nH ±0.5nH	100MHz	30	250MHz	800mA	0.051Ω	8GHz
LQW15AN5N3C10□	5.3nH ±0.2nH	100MHz	30	250MHz	800mA	0.051Ω	8GHz
LQW15AN5N3D10□	5.3nH ±0.5nH	100MHz	30	250MHz	800mA	0.051Ω	8GHz
LQW15AN5N4C10□	5.4nH ±0.2nH	100MHz	30	250MHz	800mA	0.051Ω	8GHz
LQW15AN5N4D10□	5.4nH ±0.5nH	100MHz	30	250MHz	800mA	0.051Ω	8GHz
LQW15AN5N5C10□	5.5nH ±0.2nH	100MHz	30	250MHz	800mA	0.051Ω	8GHz
LQW15AN5N5D10□	5.5nH ±0.5nH	100MHz	30	250MHz	800mA	0.051Ω	8GHz
LQW15AN5N6C10□	5.6nH ±0.2nH	100MHz	30	250MHz	800mA	0.051Ω	8GHz
LQW15AN5N6D10□	5.6nH ±0.5nH	100MHz	30	250MHz	800mA	0.051Ω	8GHz
LQW15AN5N7C10□	5.7nH ±0.2nH	100MHz	30	250MHz	800mA	0.051Ω	8GHz
LQW15AN5N7D10□	5.7nH ±0.5nH	100MHz	30	250MHz	800mA	0.051Ω	8GHz
LQW15AN5N9C10□	5.9nH ±0.2nH	100MHz	30	250MHz	760mA	0.056Ω	7.7GHz
LQW15AN5N9D10□	5.9nH ±0.5nH	100MHz	30	250MHz	760mA	0.056Ω	7.7GHz
LQW15AN6N0C10□	6.0nH ±0.2nH	100MHz	30	250MHz	760mA	0.056Ω	7.7GHz
LQW15AN6N0D10□	6.0nH ±0.5nH	100MHz	30	250MHz	760mA	0.056Ω	7.7GHz
LQW15AN6N1C10□	6.1nH ±0.2nH	100MHz	30	250MHz	760mA	0.056Ω	7.7GHz
LQW15AN6N1D10□	6.1nH ±0.5nH	100MHz	30	250MHz	760mA	0.056Ω	7.7GHz
LQW15AN7N4C10□	7.4nH ±0.2nH	100MHz	30	250MHz	750mA	0.058Ω	6.8GHz
LQW15AN7N4D10□	7.4nH ±0.5nH	100MHz	30	250MHz	750mA	0.058Ω	6.8GHz
LQW15AN7N6C10□	7.6nH ±0.2nH	100MHz	30	250MHz	750mA	0.058Ω	6.8GHz
LQW15AN7N6D10□	7.6nH ±0.5nH	100MHz	30	250MHz	750mA	0.058Ω	6.8GHz
LQW15AN7N7C10□	7.7nH ±0.2nH	100MHz	30	250MHz	750mA	0.058Ω	6.8GHz
LQW15AN7N7D10□	7.7nH ±0.5nH	100MHz	30	250MHz	750mA	0.058Ω	6.8GHz
LQW15AN7N8C10□	7.8nH ±0.2nH	100MHz	30	250MHz	750mA	0.058Ω	6.8GHz
LQW15AN7N8D10□	7.8nH ±0.5nH	100MHz	30	250MHz	750mA	0.058Ω	6.8GHz
LQW15AN7N9C10□	7.9nH ±0.2nH	100MHz	30	250MHz	640mA	0.079Ω	7.5GHz
LQW15AN7N9D10□	7.9nH ±0.5nH	100MHz	30	250MHz	640mA	0.079Ω	7.5GHz
LQW15AN8N0C10□	8.0nH ±0.2nH	100MHz	30	250MHz	640mA	0.079Ω	7.5GHz
LQW15AN8N0D10□	8.0nH ±0.5nH	100MHz	30	250MHz	640mA	0.079Ω	7.5GHz
LQW15AN8N1C10□	8.1nH ±0.2nH	100MHz	30	250MHz	640mA	0.079Ω	7.5GHz
LQW15AN8N1D10□	8.1nH ±0.5nH	100MHz	30	250MHz	640mA	0.079Ω	7.5GHz
LQW15AN8N3C10□	8.3nH ±0.2nH	100MHz	30	250MHz	640mA	0.079Ω	7.5GHz
LQW15AN8N3D10□	8.3nH ±0.5nH	100MHz	30	250MHz	640mA	0.079Ω	7.5GHz
LQW15AN8N4C10□	8.4nH ±0.2nH	100MHz	30	250MHz	640mA	0.079Ω	7.5GHz
LQW15AN8N4D10□	8.4nH ±0.5nH	100MHz	30	250MHz	640mA	0.079Ω	7.5GHz

Operating temp. range: -55 to 125°C

Only for reflow soldering

*S.R.F.: Self Resonant Frequency

Inductance-Frequency Characteristics (Typ.)



Q-Frequency Characteristics (Typ.)



LQW15AN_80 Series 0402 (1005) inch (mm)



Packaging Code	Packaging	Minimum Quantity
D	ø180mm Paper Taping	10000
B	Packing in Bulk	500

Part Number (□: packaging code)	Inductance	Inductance Test Frequency	Q (min.)	Q Test Frequency	Rated Current	Max. of DC Resistance	S.R.F.* (min.)
LQW15AN1N3C80□	1.3nH ±0.2nH	100MHz	20	250MHz	3150mA	0.012Ω	18.0GHz
LQW15AN1N3D80□	1.3nH ±0.5nH	100MHz	20	250MHz	3150mA	0.012Ω	18.0GHz
LQW15AN1N5C80□	1.5nH ±0.2nH	100MHz	20	250MHz	2100mA	0.028Ω	18.0GHz
LQW15AN1N5D80□	1.5nH ±0.5nH	100MHz	20	250MHz	2100mA	0.028Ω	18.0GHz
LQW15AN1N6C80□	1.6nH ±0.2nH	100MHz	20	250MHz	1450mA	0.045Ω	18.0GHz
LQW15AN1N6D80□	1.6nH ±0.5nH	100MHz	20	250MHz	1450mA	0.045Ω	18.0GHz
LQW15AN1N7C80□	1.7nH ±0.2nH	100MHz	20	250MHz	1150mA	0.065Ω	18.0GHz
LQW15AN1N7D80□	1.7nH ±0.5nH	100MHz	20	250MHz	1150mA	0.065Ω	18.0GHz
LQW15AN2N2B80□	2.2nH ±0.1nH	100MHz	30	250MHz	2530mA	0.022Ω	15.5GHz
LQW15AN2N2C80□	2.2nH ±0.2nH	100MHz	30	250MHz	2530mA	0.022Ω	15.5GHz
LQW15AN2N2D80□	2.2nH ±0.5nH	100MHz	30	250MHz	2530mA	0.022Ω	15.5GHz
LQW15AN2N2G80□	2.2nH ±2%	100MHz	30	250MHz	2530mA	0.022Ω	15.5GHz
LQW15AN2N3B80□	2.3nH ±0.1nH	100MHz	30	250MHz	2530mA	0.022Ω	15.5GHz
LQW15AN2N3C80□	2.3nH ±0.2nH	100MHz	30	250MHz	2530mA	0.022Ω	15.5GHz
LQW15AN2N3D80□	2.3nH ±0.5nH	100MHz	30	250MHz	2530mA	0.022Ω	15.5GHz
LQW15AN2N3G80□	2.3nH ±2%	100MHz	30	250MHz	2530mA	0.022Ω	15.5GHz
LQW15AN2N4B80□	2.4nH ±0.1nH	100MHz	30	250MHz	2530mA	0.022Ω	15.5GHz
LQW15AN2N4C80□	2.4nH ±0.2nH	100MHz	30	250MHz	2530mA	0.022Ω	15.5GHz
LQW15AN2N4D80□	2.4nH ±0.5nH	100MHz	30	250MHz	2530mA	0.022Ω	15.5GHz
LQW15AN2N4G80□	2.4nH ±2%	100MHz	30	250MHz	2530mA	0.022Ω	15.5GHz
LQW15AN2N5B80□	2.5nH ±0.1nH	100MHz	30	250MHz	2100mA	0.030Ω	15.5GHz
LQW15AN2N5C80□	2.5nH ±0.2nH	100MHz	30	250MHz	2100mA	0.030Ω	15.5GHz
LQW15AN2N5D80□	2.5nH ±0.5nH	100MHz	30	250MHz	2100mA	0.030Ω	15.5GHz
LQW15AN2N5G80□	2.5nH ±2%	100MHz	30	250MHz	2100mA	0.030Ω	15.5GHz
LQW15AN2N6B80□	2.6nH ±0.1nH	100MHz	30	250MHz	1950mA	0.035Ω	14.5GHz
LQW15AN2N6C80□	2.6nH ±0.2nH	100MHz	30	250MHz	1950mA	0.035Ω	14.5GHz
LQW15AN2N6D80□	2.6nH ±0.5nH	100MHz	30	250MHz	1950mA	0.035Ω	14.5GHz
LQW15AN2N6G80□	2.6nH ±2%	100MHz	30	250MHz	1950mA	0.035Ω	14.5GHz
LQW15AN2N7B80□	2.7nH ±0.1nH	100MHz	28	250MHz	1500mA	0.047Ω	14.0GHz
LQW15AN2N7C80□	2.7nH ±0.2nH	100MHz	28	250MHz	1500mA	0.047Ω	14.0GHz
LQW15AN2N7D80□	2.7nH ±0.5nH	100MHz	28	250MHz	1500mA	0.047Ω	14.0GHz
LQW15AN2N7G80□	2.7nH ±2%	100MHz	28	250MHz	1500mA	0.047Ω	14.0GHz
LQW15AN2N8B80□	2.8nH ±0.1nH	100MHz	27	250MHz	1500mA	0.047Ω	13.5GHz
LQW15AN2N8C80□	2.8nH ±0.2nH	100MHz	27	250MHz	1500mA	0.047Ω	13.5GHz
LQW15AN2N8D80□	2.8nH ±0.5nH	100MHz	27	250MHz	1500mA	0.047Ω	13.5GHz
LQW15AN2N8G80□	2.8nH ±2%	100MHz	27	250MHz	1500mA	0.047Ω	13.5GHz
LQW15AN2N9B80□	2.9nH ±0.1nH	100MHz	25	250MHz	1500mA	0.047Ω	12.5GHz
LQW15AN2N9C80□	2.9nH ±0.2nH	100MHz	25	250MHz	1500mA	0.047Ω	12.5GHz
LQW15AN2N9D80□	2.9nH ±0.5nH	100MHz	25	250MHz	1500mA	0.047Ω	12.5GHz

Operating temp. range: -55 to 125°C

Only for reflow soldering

*S.R.F.: Self Resonant Frequency

In operating temperatures exceeding +85°C, derating of current is necessary for the LQW15A_80 series. Please apply the derating curve shown in the chart according to the operating temperature. Please consider "Notice (Rating)."

Continued on the following page. ↗

Continued from the preceding page. ↘

Part Number (□: packaging code)	Inductance	Inductance Test Frequency	Q (min.)	Q Test Frequency	Rated Current	Max. of DC Resistance	S.R.F.* (min.)
LQW15AN2N9G80□	2.9nH ±2%	100MHz	25	250MHz	1500mA	0.047Ω	12.5GHz
LQW15AN3NOB80□	3nH ±0.1nH	100MHz	20	250MHz	1350mA	0.063Ω	12.5GHz
LQW15AN3NOC80□	3nH ±0.2nH	100MHz	20	250MHz	1350mA	0.063Ω	12.5GHz
LQW15AN3NOD80□	3nH ±0.5nH	100MHz	20	250MHz	1350mA	0.063Ω	12.5GHz
LQW15AN3NOG80□	3.0nH ±2%	100MHz	20	250MHz	1350mA	0.063Ω	12.5GHz
LQW15AN3N3B80□	3.3nH ±0.1nH	100MHz	30	250MHz	2000mA	0.030Ω	14.0GHz
LQW15AN3N3C80□	3.3nH ±0.2nH	100MHz	30	250MHz	2000mA	0.030Ω	14.0GHz
LQW15AN3N3D80□	3.3nH ±0.5nH	100MHz	30	250MHz	2000mA	0.030Ω	14.0GHz
LQW15AN3N3G80□	3.3nH ±2%	100MHz	30	250MHz	2000mA	0.030Ω	14.0GHz
LQW15AN3N4B80□	3.4nH ±0.1nH	100MHz	30	250MHz	1950mA	0.030Ω	10.0GHz
LQW15AN3N4C80□	3.4nH ±0.2nH	100MHz	30	250MHz	1950mA	0.030Ω	10.0GHz
LQW15AN3N4D80□	3.4nH ±0.5nH	100MHz	30	250MHz	1950mA	0.030Ω	10.0GHz
LQW15AN3N4G80□	3.4nH ±2%	100MHz	30	250MHz	1950mA	0.030Ω	10.0GHz
LQW15AN3N5B80□	3.5nH ±0.1nH	100MHz	30	250MHz	1950mA	0.030Ω	10.0GHz
LQW15AN3N5C80□	3.5nH ±0.2nH	100MHz	30	250MHz	1950mA	0.030Ω	10.0GHz
LQW15AN3N5D80□	3.5nH ±0.5nH	100MHz	30	250MHz	1950mA	0.030Ω	10.0GHz
LQW15AN3N5G80□	3.5nH ±2%	100MHz	30	250MHz	1950mA	0.030Ω	10.0GHz
LQW15AN3N6B80□	3.6nH ±0.1nH	100MHz	30	250MHz	1950mA	0.030Ω	10.0GHz
LQW15AN3N6C80□	3.6nH ±0.2nH	100MHz	30	250MHz	1950mA	0.030Ω	10.0GHz
LQW15AN3N6D80□	3.6nH ±0.5nH	100MHz	30	250MHz	1950mA	0.030Ω	10.0GHz
LQW15AN3N6G80□	3.6nH ±2%	100MHz	30	250MHz	1950mA	0.030Ω	10.0GHz
LQW15AN3N7B80□	3.7nH ±0.1nH	100MHz	35	250MHz	1950mA	0.030Ω	10.0GHz
LQW15AN3N7C80□	3.7nH ±0.2nH	100MHz	35	250MHz	1950mA	0.030Ω	10.0GHz
LQW15AN3N7D80□	3.7nH ±0.5nH	100MHz	35	250MHz	1950mA	0.030Ω	10.0GHz
LQW15AN3N7G80□	3.7nH ±2%	100MHz	35	250MHz	1950mA	0.030Ω	10.0GHz
LQW15AN3N8B80□	3.8nH ±0.1nH	100MHz	35	250MHz	1950mA	0.030Ω	10.0GHz
LQW15AN3N8C80□	3.8nH ±0.2nH	100MHz	35	250MHz	1950mA	0.030Ω	10.0GHz
LQW15AN3N8D80□	3.8nH ±0.5nH	100MHz	35	250MHz	1950mA	0.030Ω	10.0GHz
LQW15AN3N8G80□	3.8nH ±2%	100MHz	35	250MHz	1950mA	0.030Ω	10.0GHz
LQW15AN3N9B80□	3.9nH ±0.1nH	100MHz	35	250MHz	1950mA	0.030Ω	10.0GHz
LQW15AN3N9C80□	3.9nH ±0.2nH	100MHz	35	250MHz	1950mA	0.030Ω	10.0GHz
LQW15AN3N9D80□	3.9nH ±0.5nH	100MHz	35	250MHz	1950mA	0.030Ω	10.0GHz
LQW15AN3N9G80□	3.9nH ±2%	100MHz	35	250MHz	1950mA	0.030Ω	10.0GHz
LQW15AN4NOB80□	4.0nH ±0.1nH	100MHz	30	250MHz	1950mA	0.030Ω	10.0GHz
LQW15AN4NOC80□	4.0nH ±0.2nH	100MHz	30	250MHz	1950mA	0.030Ω	10.0GHz
LQW15AN4NOD80□	4.0nH ±0.5nH	100MHz	30	250MHz	1950mA	0.030Ω	10.0GHz
LQW15AN4NOG80□	4.0nH ±2%	100MHz	30	250MHz	1950mA	0.030Ω	10.0GHz
LQW15AN4N1B80□	4.1nH ±0.1nH	100MHz	30	250MHz	1800mA	0.044Ω	9.6GHz
LQW15AN4N1C80□	4.1nH ±0.2nH	100MHz	30	250MHz	1800mA	0.044Ω	9.6GHz
LQW15AN4N1D80□	4.1nH ±0.5nH	100MHz	30	250MHz	1800mA	0.044Ω	9.6GHz
LQW15AN4N1G80□	4.1nH ±2%	100MHz	30	250MHz	1800mA	0.044Ω	9.6GHz
LQW15AN4N2B80□	4.2nH ±0.1nH	100MHz	30	250MHz	1800mA	0.044Ω	9.6GHz
LQW15AN4N2C80□	4.2nH ±0.2nH	100MHz	30	250MHz	1800mA	0.044Ω	9.6GHz
LQW15AN4N2D80□	4.2nH ±0.5nH	100MHz	30	250MHz	1800mA	0.044Ω	9.6GHz
LQW15AN4N2G80□	4.2nH ±2%	100MHz	30	250MHz	1800mA	0.044Ω	9.6GHz
LQW15AN4N3B80□	4.3nH ±0.1nH	100MHz	32	250MHz	1800mA	0.044Ω	9.6GHz
LQW15AN4N3C80□	4.3nH ±0.2nH	100MHz	32	250MHz	1800mA	0.044Ω	9.6GHz
LQW15AN4N3D80□	4.3nH ±0.5nH	100MHz	32	250MHz	1800mA	0.044Ω	9.6GHz
LQW15AN4N3G80□	4.3nH ±2%	100MHz	32	250MHz	1800mA	0.044Ω	9.6GHz
LQW15AN4N4B80□	4.4nH ±0.1nH	100MHz	34	250MHz	1600mA	0.052Ω	9.6GHz
LQW15AN4N4C80□	4.4nH ±0.2nH	100MHz	34	250MHz	1600mA	0.052Ω	9.6GHz

Operating temp. range: -55 to 125°C

Only for reflow soldering

*S.R.F.: Self Resonant Frequency

In operating temperatures exceeding +85°C, derating of current is necessary for the LQW15A_80 series. Please apply the derating curve shown in the chart according to the operating temperature. Please consider "Notice (Rating)."

Continued on the following page. ↗

Continued from the preceding page. ↘

Part Number (□: packaging code)	Inductance	Inductance Test Frequency	Q (min.)	Q Test Frequency	Rated Current	Max. of DC Resistance	S.R.F.* (min.)
LQW15AN4N4D80□	4.4nH ±0.5nH	100MHz	34	250MHz	1600mA	0.052Ω	9.6GHz
LQW15AN4N4G80□	4.4nH ±2%	100MHz	34	250MHz	1600mA	0.052Ω	9.6GHz
LQW15AN4N5B80□	4.5nH ±0.1nH	100MHz	34	250MHz	1450mA	0.060Ω	9.6GHz
LQW15AN4N5C80□	4.5nH ±0.2nH	100MHz	34	250MHz	1450mA	0.060Ω	9.6GHz
LQW15AN4N5D80□	4.5nH ±0.5nH	100MHz	34	250MHz	1450mA	0.060Ω	9.6GHz
LQW15AN4N5G80□	4.5nH ±2%	100MHz	34	250MHz	1450mA	0.060Ω	9.6GHz
LQW15AN4N6B80□	4.6nH ±0.1nH	100MHz	32	250MHz	1450mA	0.060Ω	9.6GHz
LQW15AN4N6C80□	4.6nH ±0.2nH	100MHz	32	250MHz	1450mA	0.060Ω	9.6GHz
LQW15AN4N6D80□	4.6nH ±0.5nH	100MHz	32	250MHz	1450mA	0.060Ω	9.6GHz
LQW15AN4N6G80□	4.6nH ±2%	100MHz	32	250MHz	1450mA	0.060Ω	9.6GHz
LQW15AN4N7B80□	4.7nH ±0.1nH	100MHz	31	250MHz	1200mA	0.071Ω	8.0GHz
LQW15AN4N7C80□	4.7nH ±0.2nH	100MHz	31	250MHz	1200mA	0.071Ω	8.0GHz
LQW15AN4N7D80□	4.7nH ±0.5nH	100MHz	31	250MHz	1200mA	0.071Ω	8.0GHz
LQW15AN4N7G80□	4.7nH ±2%	100MHz	31	250MHz	1200mA	0.071Ω	8.0GHz
LQW15AN4N8B80□	4.8nH ±0.1nH	100MHz	30	250MHz	1200mA	0.071Ω	8.0GHz
LQW15AN4N8C80□	4.8nH ±0.2nH	100MHz	30	250MHz	1200mA	0.071Ω	8.0GHz
LQW15AN4N8D80□	4.8nH ±0.5nH	100MHz	30	250MHz	1200mA	0.071Ω	8.0GHz
LQW15AN4N8G80□	4.8nH ±2%	100MHz	30	250MHz	1200mA	0.071Ω	8.0GHz
LQW15AN4N9B80□	4.9nH ±0.1nH	100MHz	27	250MHz	1200mA	0.071Ω	8.0GHz
LQW15AN4N9C80□	4.9nH ±0.2nH	100MHz	27	250MHz	1200mA	0.071Ω	8.0GHz
LQW15AN4N9D80□	4.9nH ±0.5nH	100MHz	27	250MHz	1200mA	0.071Ω	8.0GHz
LQW15AN4N9G80□	4.9nH ±2%	100MHz	27	250MHz	1200mA	0.071Ω	8.0GHz
LQW15AN5N0B80□	5.0nH ±0.1nH	100MHz	32	250MHz	1770mA	0.040Ω	10GHz
LQW15AN5N0C80□	5.0nH ±0.2nH	100MHz	32	250MHz	1770mA	0.040Ω	10GHz
LQW15AN5N0D80□	5.0nH ±0.5nH	100MHz	32	250MHz	1770mA	0.040Ω	10GHz
LQW15AN5N0G80□	5.0nH ±2%	100MHz	32	250MHz	1770mA	0.040Ω	10.0GHz
LQW15AN5N1B80□	5.1nH ±0.1nH	100MHz	35	250MHz	1770mA	0.040Ω	8.0GHz
LQW15AN5N1C80□	5.1nH ±0.2nH	100MHz	35	250MHz	1770mA	0.040Ω	8.0GHz
LQW15AN5N1D80□	5.1nH ±0.5nH	100MHz	35	250MHz	1770mA	0.040Ω	8.0GHz
LQW15AN5N1G80□	5.1nH ±2%	100MHz	35	250MHz	1770mA	0.040Ω	8.0GHz
LQW15AN5N2B80□	5.2nH ±0.1nH	100MHz	35	250MHz	1770mA	0.040Ω	8.0GHz
LQW15AN5N2C80□	5.2nH ±0.2nH	100MHz	35	250MHz	1770mA	0.040Ω	8.0GHz
LQW15AN5N2D80□	5.2nH ±0.5nH	100MHz	35	250MHz	1770mA	0.040Ω	8.0GHz
LQW15AN5N2G80□	5.2nH ±2%	100MHz	35	250MHz	1770mA	0.040Ω	8.0GHz
LQW15AN5N3B80□	5.3nH ±0.1nH	100MHz	35	250MHz	1770mA	0.040Ω	8.0GHz
LQW15AN5N3C80□	5.3nH ±0.2nH	100MHz	35	250MHz	1770mA	0.040Ω	8.0GHz
LQW15AN5N3D80□	5.3nH ±0.5nH	100MHz	35	250MHz	1770mA	0.040Ω	8.0GHz
LQW15AN5N3G80□	5.3nH ±2%	100MHz	35	250MHz	1770mA	0.040Ω	8.0GHz
LQW15AN5N4B80□	5.4nH ±0.1nH	100MHz	35	250MHz	1770mA	0.040Ω	8.0GHz
LQW15AN5N4C80□	5.4nH ±0.2nH	100MHz	35	250MHz	1770mA	0.040Ω	8.0GHz
LQW15AN5N4D80□	5.4nH ±0.5nH	100MHz	35	250MHz	1770mA	0.040Ω	8.0GHz
LQW15AN5N4G80□	5.4nH ±2%	100MHz	35	250MHz	1770mA	0.040Ω	8.0GHz
LQW15AN5N5B80□	5.5nH ±0.1nH	100MHz	35	250MHz	1770mA	0.040Ω	8.0GHz
LQW15AN5N5C80□	5.5nH ±0.2nH	100MHz	35	250MHz	1770mA	0.040Ω	8.0GHz
LQW15AN5N5D80□	5.5nH ±0.5nH	100MHz	35	250MHz	1770mA	0.040Ω	8.0GHz
LQW15AN5N5G80□	5.5nH ±2%	100MHz	35	250MHz	1770mA	0.040Ω	8.0GHz
LQW15AN5N6B80□	5.6nH ±0.1nH	100MHz	35	250MHz	1770mA	0.040Ω	8.0GHz
LQW15AN5N6C80□	5.6nH ±0.2nH	100MHz	35	250MHz	1770mA	0.040Ω	8.0GHz
LQW15AN5N6D80□	5.6nH ±0.5nH	100MHz	35	250MHz	1770mA	0.040Ω	8.0GHz
LQW15AN5N6G80□	5.6nH ±2%	100MHz	35	250MHz	1770mA	0.040Ω	8.0GHz
LQW15AN5N7B80□	5.7nH ±0.1nH	100MHz	30	250MHz	1770mA	0.040Ω	8.0GHz

Operating temp. range: -55 to 125°C

Only for reflow soldering

*S.R.F.: Self Resonant Frequency

In operating temperatures exceeding +85°C, derating of current is necessary for the LQW15A_80 series. Please apply the derating curve shown in the chart according to the operating temperature. Please consider "Notice (Rating)."

Continued on the following page. ↗

Continued from the preceding page. ↘

Part Number (□: packaging code)	Inductance	Inductance Test Frequency	Q (min.)	Q Test Frequency	Rated Current	Max. of DC Resistance	S.R.F.* (min.)
LQW15AN5N7C80□	5.7nH ±0.2nH	100MHz	30	250MHz	1770mA	0.040Ω	8.0GHz
LQW15AN5N7D80□	5.7nH ±0.5nH	100MHz	30	250MHz	1770mA	0.040Ω	8.0GHz
LQW15AN5N7G80□	5.7nH ±2%	100MHz	30	250MHz	1770mA	0.040Ω	8.0GHz
LQW15AN5N8B80□	5.8nH ±0.1nH	100MHz	30	250MHz	1770mA	0.040Ω	8.0GHz
LQW15AN5N8C80□	5.8nH ±0.2nH	100MHz	30	250MHz	1770mA	0.040Ω	8.0GHz
LQW15AN5N8D80□	5.8nH ±0.5nH	100MHz	30	250MHz	1770mA	0.040Ω	8.0GHz
LQW15AN5N8G80□	5.8nH ±2%	100MHz	30	250MHz	1770mA	0.040Ω	8.0GHz
LQW15AN5N9B80□	5.9nH ±0.1nH	100MHz	30	250MHz	1770mA	0.040Ω	8.0GHz
LQW15AN5N9C80□	5.9nH ±0.2nH	100MHz	30	250MHz	1770mA	0.040Ω	8.0GHz
LQW15AN5N9D80□	5.9nH ±0.5nH	100MHz	30	250MHz	1770mA	0.040Ω	8.0GHz
LQW15AN5N9G80□	5.9nH ±2%	100MHz	30	250MHz	1770mA	0.040Ω	8.0GHz
LQW15AN6NOB80□	6.0nH ±0.1nH	100MHz	32	250MHz	1600mA	0.056Ω	8.0GHz
LQW15AN6NOC80□	6.0nH ±0.2nH	100MHz	32	250MHz	1600mA	0.056Ω	8.0GHz
LQW15AN6NOD80□	6.0nH ±0.5nH	100MHz	32	250MHz	1600mA	0.056Ω	8.0GHz
LQW15AN6NOG80□	6.0nH ±2%	100MHz	32	250MHz	1600mA	0.056Ω	8.0GHz
LQW15AN6N1B80□	6.1nH ±0.1nH	100MHz	32	250MHz	1600mA	0.056Ω	8.0GHz
LQW15AN6N1C80□	6.1nH ±0.2nH	100MHz	32	250MHz	1600mA	0.056Ω	8.0GHz
LQW15AN6N1D80□	6.1nH ±0.5nH	100MHz	32	250MHz	1600mA	0.056Ω	8.0GHz
LQW15AN6N1G80□	6.1nH ±2%	100MHz	32	250MHz	1600mA	0.056Ω	8.0GHz
LQW15AN6N2B80□	6.2nH ±0.1nH	100MHz	33	250MHz	1600mA	0.056Ω	8.0GHz
LQW15AN6N2C80□	6.2nH ±0.2nH	100MHz	33	250MHz	1600mA	0.056Ω	8.0GHz
LQW15AN6N2D80□	6.2nH ±0.5nH	100MHz	33	250MHz	1600mA	0.056Ω	8.0GHz
LQW15AN6N2G80□	6.2nH ±2%	100MHz	33	250MHz	1600mA	0.056Ω	8.0GHz
LQW15AN6N3G80□	6.3nH ±2%	100MHz	32	250MHz	1600mA	0.057Ω	7.8GHz
LQW15AN6N3J80□	6.3nH ±5%	100MHz	32	250MHz	1600mA	0.057Ω	7.8GHz
LQW15AN6N4G80□	6.4nH ±2%	100MHz	33	250MHz	1380mA	0.065Ω	7.0GHz
LQW15AN6N4J80□	6.4nH ±5%	100MHz	33	250MHz	1380mA	0.065Ω	7.0GHz
LQW15AN6N5G80□	6.5nH ±2%	100MHz	32	250MHz	1380mA	0.065Ω	7.0GHz
LQW15AN6N5J80□	6.5nH ±5%	100MHz	32	250MHz	1380mA	0.065Ω	7.0GHz
LQW15AN6N6G80□	6.6nH ±2%	100MHz	30	250MHz	1280mA	0.078Ω	7.0GHz
LQW15AN6N6J80□	6.6nH ±5%	100MHz	30	250MHz	1280mA	0.078Ω	7.0GHz
LQW15AN6N7G80□	6.7nH ±2%	100MHz	30	250MHz	1280mA	0.078Ω	7.0GHz
LQW15AN6N7J80□	6.7nH ±5%	100MHz	30	250MHz	1280mA	0.078Ω	7.0GHz
LQW15AN6N8G80□	6.8nH ±2%	100MHz	30	250MHz	1450mA	0.068Ω	7.0GHz
LQW15AN6N8J80□	6.8nH ±5%	100MHz	30	250MHz	1450mA	0.068Ω	7.0GHz
LQW15AN6N9G80□	6.9nH ±2%	100MHz	32	250MHz	1420mA	0.069Ω	8.5GHz
LQW15AN6N9J80□	6.9nH ±5%	100MHz	32	250MHz	1420mA	0.069Ω	8.5GHz
LQW15AN7NOG80□	7.0nH ±2%	100MHz	33	250MHz	1420mA	0.069Ω	8.0GHz
LQW15AN7NOJ80□	7.0nH ±5%	100MHz	33	250MHz	1420mA	0.069Ω	8.0GHz
LQW15AN7N1G80□	7.1nH ±2%	100MHz	32	250MHz	1420mA	0.069Ω	7.0GHz
LQW15AN7N1J80□	7.1nH ±5%	100MHz	32	250MHz	1420mA	0.069Ω	7.0GHz
LQW15AN7N2G80□	7.2nH ±2%	100MHz	32	250MHz	1700mA	0.050Ω	7.0GHz
LQW15AN7N2J80□	7.2nH ±5%	100MHz	32	250MHz	1700mA	0.050Ω	7.0GHz
LQW15AN7N3G80□	7.3nH ±2%	100MHz	32	250MHz	1700mA	0.050Ω	7.0GHz
LQW15AN7N3J80□	7.3nH ±5%	100MHz	32	250MHz	1700mA	0.050Ω	7.0GHz
LQW15AN7N4G80□	7.4nH ±2%	100MHz	30	250MHz	1700mA	0.050Ω	7.0GHz
LQW15AN7N4J80□	7.4nH ±5%	100MHz	30	250MHz	1700mA	0.050Ω	7.0GHz
LQW15AN7N5G80□	7.5nH ±2%	100MHz	35	250MHz	1700mA	0.050Ω	7.0GHz
LQW15AN7N5J80□	7.5nH ±5%	100MHz	35	250MHz	1700mA	0.050Ω	7.0GHz
LQW15AN7N6G80□	7.6nH ±2%	100MHz	30	250MHz	1700mA	0.050Ω	7.0GHz
LQW15AN7N6J80□	7.6nH ±5%	100MHz	30	250MHz	1700mA	0.050Ω	7.0GHz

Operating temp. range: -55 to 125°C

Only for reflow soldering

*S.R.F.: Self Resonant Frequency

In operating temperatures exceeding +85°C, derating of current is necessary for the LQW15A_80 series. Please apply the derating curve shown in the chart according to the operating temperature. Please consider "Notice (Rating)."

Continued on the following page. ↗

Continued from the preceding page. ↘

Part Number (□: packaging code)	Inductance	Inductance Test Frequency	Q (min.)	Q Test Frequency	Rated Current	Max. of DC Resistance	S.R.F.* (min.)
LQW15AN7N7G80□	7.7nH ±2%	100MHz	30	250MHz	1700mA	0.050Ω	7.0GHz
LQW15AN7N7J80□	7.7nH ±5%	100MHz	30	250MHz	1700mA	0.050Ω	7.0GHz
LQW15AN7N8G80□	7.8nH ±2%	100MHz	30	250MHz	1700mA	0.050Ω	7.0GHz
LQW15AN7N8J80□	7.8nH ±5%	100MHz	30	250MHz	1700mA	0.050Ω	7.0GHz
LQW15AN7N9G80□	7.9nH ±2%	100MHz	30	250MHz	1700mA	0.050Ω	7.0GHz
LQW15AN7N9J80□	7.9nH ±5%	100MHz	30	250MHz	1700mA	0.050Ω	7.0GHz
LQW15AN8N0G80□	8.0nH ±2%	100MHz	30	250MHz	1700mA	0.050Ω	7.0GHz
LQW15AN8N0J80□	8.0nH ±5%	100MHz	30	250MHz	1700mA	0.050Ω	7.0GHz
LQW15AN8N1G80□	8.1nH ±2%	100MHz	32	250MHz	1500mA	0.069Ω	6.5GHz
LQW15AN8N1J80□	8.1nH ±5%	100MHz	32	250MHz	1500mA	0.069Ω	6.5GHz
LQW15AN8N2G80□	8.2nH ±2%	100MHz	32	250MHz	1500mA	0.069Ω	6.5GHz
LQW15AN8N2J80□	8.2nH ±5%	100MHz	32	250MHz	1500mA	0.069Ω	6.5GHz
LQW15AN8N3G80□	8.3nH ±2%	100MHz	32	250MHz	1500mA	0.069Ω	6.5GHz
LQW15AN8N3J80□	8.3nH ±5%	100MHz	32	250MHz	1500mA	0.069Ω	6.5GHz
LQW15AN8N4G80□	8.4nH ±2%	100MHz	32	250MHz	1500mA	0.069Ω	6.5GHz
LQW15AN8N4J80□	8.4nH ±5%	100MHz	32	250MHz	1500mA	0.069Ω	6.5GHz
LQW15AN8N5G80□	8.5nH ±2%	100MHz	32	250MHz	1500mA	0.069Ω	6.5GHz
LQW15AN8N5J80□	8.5nH ±5%	100MHz	32	250MHz	1500mA	0.069Ω	6.5GHz
LQW15AN8N6G80□	8.6nH ±2%	100MHz	31	250MHz	1420mA	0.070Ω	6.5GHz
LQW15AN8N6J80□	8.6nH ±5%	100MHz	31	250MHz	1420mA	0.070Ω	6.5GHz
LQW15AN8N7G80□	8.7nH ±2%	100MHz	31	250MHz	1420mA	0.070Ω	6.5GHz
LQW15AN8N7J80□	8.7nH ±5%	100MHz	31	250MHz	1420mA	0.070Ω	6.5GHz
LQW15AN8N8G80□	8.8nH ±2%	100MHz	31	250MHz	1420mA	0.070Ω	6.5GHz
LQW15AN8N8J80□	8.8nH ±5%	100MHz	31	250MHz	1420mA	0.070Ω	6.5GHz
LQW15AN8N9G80□	8.9nH ±2%	100MHz	31	250MHz	1420mA	0.070Ω	6.5GHz
LQW15AN8N9J80□	8.9nH ±5%	100MHz	31	250MHz	1420mA	0.070Ω	6.5GHz
LQW15AN9N0G80□	9nH ±2%	100MHz	30	250MHz	1420mA	0.070Ω	6.5GHz
LQW15AN9N0J80□	9nH ±5%	100MHz	30	250MHz	1420mA	0.070Ω	6.5GHz
LQW15AN9N1G80□	9.1nH ±2%	100MHz	32	250MHz	1400mA	0.080Ω	6.5GHz
LQW15AN9N1J80□	9.1nH ±5%	100MHz	32	250MHz	1400mA	0.080Ω	6.5GHz
LQW15AN9N2G80□	9.2nH ±2%	100MHz	32	250MHz	1400mA	0.081Ω	6.0GHz
LQW15AN9N2J80□	9.2nH ±5%	100MHz	32	250MHz	1400mA	0.081Ω	6.0GHz
LQW15AN9N3G80□	9.3nH ±2%	100MHz	34	250MHz	1400mA	0.081Ω	6.0GHz
LQW15AN9N3J80□	9.3nH ±5%	100MHz	34	250MHz	1400mA	0.081Ω	6.0GHz
LQW15AN9N4G80□	9.4nH ±2%	100MHz	33	250MHz	1400mA	0.081Ω	6.0GHz
LQW15AN9N4J80□	9.4nH ±5%	100MHz	33	250MHz	1400mA	0.081Ω	6.0GHz
LQW15AN9N5G80□	9.5nH ±2%	100MHz	32	250MHz	1400mA	0.081Ω	6.0GHz
LQW15AN9N5J80□	9.5nH ±5%	100MHz	32	250MHz	1400mA	0.081Ω	6.0GHz
LQW15AN9N6G80□	9.6nH ±2%	100MHz	33	250MHz	1400mA	0.081Ω	6.0GHz
LQW15AN9N6J80□	9.6nH ±5%	100MHz	33	250MHz	1400mA	0.081Ω	6.0GHz
LQW15AN9N7G80□	9.7nH ±2%	100MHz	33	250MHz	1400mA	0.081Ω	6.0GHz
LQW15AN9N7J80□	9.7nH ±5%	100MHz	33	250MHz	1400mA	0.081Ω	6.0GHz
LQW15AN9N8G80□	9.8nH ±2%	100MHz	34	250MHz	1400mA	0.081Ω	6.0GHz
LQW15AN9N8J80□	9.8nH ±5%	100MHz	34	250MHz	1400mA	0.081Ω	6.0GHz
LQW15AN9N9G80□	9.9nH ±2%	100MHz	32	250MHz	1400mA	0.081Ω	6.0GHz
LQW15AN9N9J80□	9.9nH ±5%	100MHz	32	250MHz	1400mA	0.081Ω	6.0GHz
LQW15AN10NG80□	10nH ±2%	100MHz	31	250MHz	1400mA	0.081Ω	6.0GHz
LQW15AN10NJ80□	10nH ±5%	100MHz	31	250MHz	1400mA	0.081Ω	6.0GHz
LQW15AN11NG80□	11nH ±2%	100MHz	32	250MHz	1400mA	0.083Ω	6.2GHz
LQW15AN11NJ80□	11nH ±5%	100MHz	32	250MHz	1400mA	0.083Ω	6.2GHz
LQW15AN12NG80□	12nH ±2%	100MHz	30	250MHz	1240mA	0.093Ω	5.2GHz

Operating temp. range: -55 to 125°C

Only for reflow soldering

*S.R.F.: Self Resonant Frequency

In operating temperatures exceeding +85°C, derating of current is necessary for the LQW15A_80 series. Please apply the derating curve shown in the chart according to the operating temperature. Please consider "Notice (Rating)."

Continued on the following page. ↗

Inductors for Power Lines

Inductors for General Circuits

RF Inductors
LQW15AN_80

Continued from the preceding page. ↘

Part Number (□: packaging code)	Inductance	Inductance Test Frequency	Q (min.)	Q Test Frequency	Rated Current	Max. of DC Resistance	S.R.F.* (min.)
LQW15AN12NJ80□	12nH ±5%	100MHz	30	250MHz	1240mA	0.093Ω	5.2GHz
LQW15AN13NG80□	13nH ±2%	100MHz	30	250MHz	1240mA	0.093Ω	5.2GHz
LQW15AN13NJ80□	13nH ±5%	100MHz	30	250MHz	1240mA	0.093Ω	5.2GHz
LQW15AN14NG80□	14nH ±2%	100MHz	31	250MHz	1150mA	0.111Ω	5.2GHz
LQW15AN14NJ80□	14nH ±5%	100MHz	31	250MHz	1150mA	0.111Ω	5.2GHz
LQW15AN15NG80□	15nH ±2%	100MHz	31	250MHz	1150mA	0.114Ω	5.5GHz
LQW15AN15NJ80□	15nH ±5%	100MHz	31	250MHz	1150mA	0.114Ω	5.5GHz
LQW15AN16NG80□	16nH ±2%	100MHz	31	250MHz	1000mA	0.126Ω	5.0GHz
LQW15AN16NJ80□	16nH ±5%	100MHz	31	250MHz	1000mA	0.126Ω	5.0GHz
LQW15AN17NG80□	17nH ±2%	100MHz	30	250MHz	1000mA	0.126Ω	5.0GHz
LQW15AN17NJ80□	17nH ±5%	100MHz	30	250MHz	1000mA	0.126Ω	5.0GHz
LQW15AN18NG80□	18nH ±2%	100MHz	30	250MHz	1050mA	0.130Ω	5.2GHz
LQW15AN18NJ80□	18nH ±5%	100MHz	30	250MHz	1050mA	0.130Ω	5.2GHz
LQW15AN19NG80□	19nH ±2%	100MHz	30	250MHz	920mA	0.156Ω	5.0GHz
LQW15AN19NJ80□	19nH ±5%	100MHz	30	250MHz	920mA	0.156Ω	5.0GHz
LQW15AN20NG80□	20nH ±2%	100MHz	30	250MHz	800mA	0.186Ω	4.5GHz
LQW15AN20NJ80□	20nH ±5%	100MHz	30	250MHz	800mA	0.186Ω	4.5GHz
LQW15AN21NG80□	21nH ±2%	100MHz	30	250MHz	780mA	0.202Ω	4.5GHz
LQW15AN21NJ80□	21nH ±5%	100MHz	30	250MHz	780mA	0.202Ω	4.5GHz
LQW15AN22NG80□	22nH ±2%	100MHz	30	250MHz	780mA	0.202Ω	4.5GHz
LQW15AN22NJ80□	22nH ±5%	100MHz	30	250MHz	780mA	0.202Ω	4.5GHz
LQW15AN23NG80□	23nH ±2%	100MHz	29	250MHz	760mA	0.201Ω	4.5GHz
LQW15AN23NJ80□	23nH ±5%	100MHz	29	250MHz	760mA	0.201Ω	4.5GHz
LQW15AN24NG80□	24nH ±2%	100MHz	31	250MHz	770mA	0.212Ω	4.0GHz
LQW15AN24NJ80□	24nH ±5%	100MHz	31	250MHz	770mA	0.212Ω	4.0GHz
LQW15AN25NG80□	25nH ±2%	100MHz	31	250MHz	750mA	0.221Ω	4.1GHz
LQW15AN25NJ80□	25nH ±5%	100MHz	31	250MHz	750mA	0.221Ω	4.1GHz
LQW15AN26NG80□	26nH ±2%	100MHz	29	250MHz	720mA	0.282Ω	4.1GHz
LQW15AN26NJ80□	26nH ±5%	100MHz	29	250MHz	720mA	0.282Ω	4.1GHz
LQW15AN27NG80□	27nH ±2%	100MHz	30	250MHz	680mA	0.288Ω	4.0GHz
LQW15AN27NJ80□	27nH ±5%	100MHz	30	250MHz	680mA	0.288Ω	4.0GHz
LQW15AN30NG80□	30nH ±2%	100MHz	30	250MHz	660mA	0.309Ω	3.8GHz
LQW15AN30NJ80□	30nH ±5%	100MHz	30	250MHz	660mA	0.309Ω	3.8GHz
LQW15AN33NG80□	33nH ±2%	100MHz	30	250MHz	620mA	0.336Ω	3.6GHz
LQW15AN33NJ80□	33nH ±5%	100MHz	30	250MHz	620mA	0.336Ω	3.6GHz
LQW15AN36NG80□	36nH ±2%	100MHz	30	250MHz	540mA	0.431Ω	3.5GHz
LQW15AN36NJ80□	36nH ±5%	100MHz	30	250MHz	540mA	0.431Ω	3.5GHz
LQW15AN39NG80□	39nH ±2%	100MHz	28	250MHz	530mA	0.456Ω	3.4GHz
LQW15AN39NJ80□	39nH ±5%	100MHz	28	250MHz	530mA	0.456Ω	3.4GHz
LQW15AN43NG80□	43nH ±2%	100MHz	30	250MHz	515mA	0.516Ω	3.4GHz
LQW15AN43NJ80□	43nH ±5%	100MHz	30	250MHz	515mA	0.516Ω	3.4GHz
LQW15AN47NG80□	47nH ±2%	100MHz	25	200MHz	440mA	0.648Ω	3.2GHz
LQW15AN47NJ80□	47nH ±5%	100MHz	25	200MHz	440mA	0.648Ω	3.2GHz
LQW15AN51NG80□	51nH ±2%	100MHz	25	200MHz	415mA	0.696Ω	2.9GHz
LQW15AN51NJ80□	51nH ±5%	100MHz	25	200MHz	415mA	0.696Ω	2.9GHz
LQW15AN53NG80□	53nH ±2%	100MHz	25	200MHz	415mA	0.696Ω	2.9GHz
LQW15AN53NJ80□	53nH ±5%	100MHz	25	200MHz	415mA	0.696Ω	2.9GHz
LQW15AN56NG80□	56nH ±2%	100MHz	25	200MHz	340mA	0.996Ω	2.9GHz
LQW15AN56NJ80□	56nH ±5%	100MHz	25	200MHz	340mA	0.996Ω	2.9GHz
LQW15AN68NG80□	68nH ±2%	100MHz	25	200MHz	320mA	1.128Ω	2.5GHz
LQW15AN68NJ80□	68nH ±5%	100MHz	25	200MHz	320mA	1.128Ω	2.5GHz

Operating temp. range: -55 to 125°C

Only for reflow soldering

*S.R.F.: Self Resonant Frequency

In operating temperatures exceeding +85°C, derating of current is necessary for the LQW15A_80 series. Please apply the derating curve shown in the chart according to the operating temperature. Please consider "Notice (Rating)."

Continued on the following page. ↗

Continued from the preceding page. ↘

Part Number (□: packaging code)	Inductance	Inductance Test Frequency	Q (min.)	Q Test Frequency	Rated Current	Max. of DC Resistance	S.R.F.* (min.)
LQW15AN75NG80□	75nH ±2%	100MHz	25	200MHz	320mA	1.224Ω	2.4GHz
LQW15AN75NJ80□	75nH ±5%	100MHz	25	200MHz	320mA	1.224Ω	2.4GHz

Operating temp. range: -55 to 125°C

Only for reflow soldering

*S.R.F.: Self Resonant Frequency

In operating temperatures exceeding +85°C, derating of current is necessary for the LQW15A_80 series. Please apply the derating curve shown in the chart according to the operating temperature. Please consider "Notice (Rating)."

Inductance-Frequency Characteristics (Typ.)



Q-Frequency Characteristics (Typ.)



Notice (Rating)

In operating temperatures exceeding +85°C, derating of current is necessary for this series. Please apply the derating curve shown in the chart according to the operating temperature.

Derating of Rated Current



LQW15AW_80 Series 0402 (1005) inch (mm)



Packaging Code	Packaging	Minimum Quantity
D	ø180mm Paper Taping	10000
B	Packing in Bulk	500

Part Number (□: packaging code)	Inductance	Inductance Test Frequency	Q (min.)	Q Test Frequency	Rated Current	Max. of DC Resistance	S.R.F.* (min.)
LQW15AW51NG80□	51nH ±2%	250MHz	33	250MHz	480mA	0.47Ω	2.1GHz
LQW15AW51NH80□	51nH ±3%	250MHz	33	250MHz	480mA	0.47Ω	2.1GHz
LQW15AW51NJ80□	51nH ±5%	250MHz	33	250MHz	480mA	0.47Ω	2.1GHz
LQW15AW53NG80□	53nH ±2%	250MHz	33	250MHz	480mA	0.47Ω	2.1GHz
LQW15AW53NH80□	53nH ±3%	250MHz	33	250MHz	480mA	0.47Ω	2.1GHz
LQW15AW53NJ80□	53nH ±5%	250MHz	33	250MHz	480mA	0.47Ω	2.1GHz
LQW15AW56NG80□	56nH ±2%	250MHz	33	250MHz	480mA	0.52Ω	2.1GHz
LQW15AW56NH80□	56nH ±3%	250MHz	33	250MHz	480mA	0.52Ω	2.1GHz
LQW15AW56NJ80□	56nH ±5%	250MHz	33	250MHz	480mA	0.52Ω	2.1GHz
LQW15AW68NG80□	68nH ±2%	250MHz	33	250MHz	480mA	0.56Ω	1.8GHz
LQW15AW68NH80□	68nH ±3%	250MHz	33	250MHz	480mA	0.56Ω	1.8GHz
LQW15AW68NJ80□	68nH ±5%	250MHz	33	250MHz	480mA	0.56Ω	1.8GHz
LQW15AW75NG80□	75nH ±2%	250MHz	33	250MHz	450mA	0.61Ω	1.8GHz
LQW15AW75NH80□	75nH ±3%	250MHz	33	250MHz	450mA	0.61Ω	1.8GHz
LQW15AW75NJ80□	75nH ±5%	250MHz	33	250MHz	450mA	0.61Ω	1.8GHz

Operating temp. range (Self-temp. rise included): -40 to 140°C

Only for reflow soldering

*S.R.F.: Self Resonant Frequency

In operating temperatures exceeding +85°C, derating of current is necessary for the LQW15A_80 series. Please apply the derating curve shown in the chart according to the operating temperature. Please consider "Notice (Rating)."

Continued on the following page. ↗

Continued from the preceding page. ↘

Part Number (□: packaging code)	Inductance	Inductance Test Frequency	Q (min.)	Q Test Frequency	Rated Current	Max. of DC Resistance	S.R.F.* (min.)
LQW15AW82NG80□	82nH ±2%	250MHz	33	250MHz	370mA	0.87Ω	1.7GHz
LQW15AW82NH80□	82nH ±3%	250MHz	33	250MHz	370mA	0.87Ω	1.7GHz
LQW15AW82NJ80□	82nH ±5%	250MHz	33	250MHz	370mA	0.87Ω	1.7GHz
LQW15AWR10G80□	100nH ±2%	250MHz	33	250MHz	350mA	1Ω	1.6GHz
LQW15AWR10H80□	100nH ±3%	250MHz	33	250MHz	350mA	1Ω	1.6GHz
LQW15AWR10J80□	100nH ±5%	250MHz	33	250MHz	350mA	1Ω	1.6GHz
LQW15AWR12G80□	120nH ±2%	250MHz	33	250MHz	320mA	1.2Ω	1.4GHz
LQW15AWR12H80□	120nH ±3%	250MHz	33	250MHz	320mA	1.2Ω	1.4GHz
LQW15AWR12J80□	120nH ±5%	250MHz	33	250MHz	320mA	1.2Ω	1.4GHz
LQW15AWR15G80□	150nH ±2%	100MHz	33	250MHz	280mA	1.71Ω	1.4GHz
LQW15AWR15H80□	150nH ±3%	100MHz	33	250MHz	280mA	1.71Ω	1.4GHz
LQW15AWR15J80□	150nH ±5%	100MHz	33	250MHz	280mA	1.71Ω	1.4GHz
LQW15AWR16G80□	160nH ±2%	100MHz	33	250MHz	280mA	1.86Ω	1.3GHz
LQW15AWR16H80□	160nH ±3%	100MHz	33	250MHz	280mA	1.86Ω	1.3GHz
LQW15AWR16J80□	160nH ±5%	100MHz	33	250MHz	280mA	1.86Ω	1.3GHz
LQW15AWR18G80□	180nH ±2%	100MHz	33	250MHz	260mA	2.2Ω	1.3GHz
LQW15AWR18H80□	180nH ±3%	100MHz	33	250MHz	260mA	2.2Ω	1.3GHz
LQW15AWR18J80□	180nH ±5%	100MHz	33	250MHz	260mA	2.2Ω	1.3GHz
LQW15AWR22G80□	220nH ±2%	100MHz	33	250MHz	220mA	2.75Ω	1.1GHz
LQW15AWR22H80□	220nH ±3%	100MHz	33	250MHz	220mA	2.75Ω	1.1GHz
LQW15AWR22J80□	220nH ±5%	100MHz	33	250MHz	220mA	2.75Ω	1.1GHz

Operating temp. range (Self-temp. rise included): -40 to 140°C

Only for reflow soldering

*S.R.F.: Self Resonant Frequency

In operating temperatures exceeding +85°C, derating of current is necessary for the LQW15A_80 series. Please apply the derating curve shown in the chart according to the operating temperature. Please consider "Notice (Rating)."

Inductance-Frequency Characteristics (Typ.)



Q-Frequency Characteristics (Typ.)



Notice (Rating)

In operating temperatures exceeding +85°C, derating of current is necessary for the LQW15AW_80 series. Please apply the derating curve shown in the chart according to the operating temperature.

Derating of Rated Current



LQW18AN_00 Series 0603 (1608) inch (mm)



*1 LQW18AN_1□/
 LQW18AS: 0.8±0.3

(in mm)

Packaging Code	Packaging	Minimum Quantity
D	ø180mm Paper Taping	4000
J	ø330mm Paper Taping	10000
B	Packing in Bulk	500

Continued on the following page. ↗

Continued from the preceding page. ↘

Part Number (□: packaging code)	Inductance	Inductance Test Frequency	Q (min.)	Q Test Frequency	Rated Current	Max. of DC Resistance	S.R.F.* (min.)
LQW18AN2N2D00□	2.2nH ±0.5nH	100MHz	16	250MHz	700mA	0.042Ω	6000MHz
LQW18AN3N6C00□	3.6nH ±0.2nH	100MHz	25	250MHz	850mA	0.059Ω	6000MHz
LQW18AN3N6D00□	3.6nH ±0.5nH	100MHz	25	250MHz	850mA	0.059Ω	6000MHz
LQW18AN3N9C00□	3.9nH ±0.2nH	100MHz	35	250MHz	850mA	0.059Ω	6000MHz
LQW18AN3N9D00□	3.9nH ±0.5nH	100MHz	35	250MHz	850mA	0.059Ω	6000MHz
LQW18AN4N3C00□	4.3nH ±0.2nH	100MHz	35	250MHz	850mA	0.059Ω	6000MHz
LQW18AN4N3D00□	4.3nH ±0.5nH	100MHz	35	250MHz	850mA	0.059Ω	6000MHz
LQW18AN4N7D00□	4.7nH ±0.5nH	100MHz	35	250MHz	850mA	0.059Ω	6000MHz
LQW18AN5N6C00□	5.6nH ±0.2nH	100MHz	35	250MHz	750mA	0.082Ω	6000MHz
LQW18AN5N6D00□	5.6nH ±0.5nH	100MHz	35	250MHz	750mA	0.082Ω	6000MHz
LQW18AN6N2C00□	6.2nH ±0.2nH	100MHz	35	250MHz	750mA	0.082Ω	6000MHz
LQW18AN6N2D00□	6.2nH ±0.5nH	100MHz	35	250MHz	750mA	0.082Ω	6000MHz
LQW18AN6N8C00□	6.8nH ±0.2nH	100MHz	35	250MHz	750mA	0.082Ω	6000MHz
LQW18AN6N8D00□	6.8nH ±0.5nH	100MHz	35	250MHz	750mA	0.082Ω	6000MHz
LQW18AN7N5C00□	7.5nH ±0.2nH	100MHz	35	250MHz	750mA	0.082Ω	6000MHz
LQW18AN7N5D00□	7.5nH ±0.5nH	100MHz	35	250MHz	750mA	0.082Ω	6000MHz
LQW18AN8N2C00□	8.2nH ±0.2nH	100MHz	35	250MHz	650mA	0.11Ω	6000MHz
LQW18AN8N2D00□	8.2nH ±0.5nH	100MHz	35	250MHz	650mA	0.11Ω	6000MHz
LQW18AN8N7C00□	8.7nH ±0.2nH	100MHz	35	250MHz	650mA	0.11Ω	6000MHz
LQW18AN8N7D00□	8.7nH ±0.5nH	100MHz	35	250MHz	650mA	0.11Ω	6000MHz
LQW18AN9N1C00□	9.1nH ±0.2nH	100MHz	35	250MHz	650mA	0.11Ω	6000MHz
LQW18AN9N1D00□	9.1nH ±0.5nH	100MHz	35	250MHz	650mA	0.11Ω	6000MHz
LQW18AN9N5D00□	9.5nH ±0.5nH	100MHz	35	250MHz	650mA	0.11Ω	6000MHz
LQW18AN10NG00□	10nH ±2%	100MHz	35	250MHz	650mA	0.11Ω	6000MHz
LQW18AN10NJ00□	10nH ±5%	100MHz	35	250MHz	650mA	0.11Ω	6000MHz
LQW18AN11NG00□	11nH ±2%	100MHz	35	250MHz	650mA	0.11Ω	6000MHz
LQW18AN11NJ00□	11nH ±5%	100MHz	35	250MHz	650mA	0.11Ω	6000MHz
LQW18AN12NG00□	12nH ±2%	100MHz	35	250MHz	600mA	0.13Ω	6000MHz
LQW18AN12NJ00□	12nH ±5%	100MHz	35	250MHz	600mA	0.13Ω	6000MHz
LQW18AN13NG00□	13nH ±2%	100MHz	35	250MHz	600mA	0.13Ω	6000MHz
LQW18AN13NJ00□	13nH ±5%	100MHz	35	250MHz	600mA	0.13Ω	6000MHz
LQW18AN15NG00□	15nH ±2%	100MHz	40	250MHz	600mA	0.13Ω	6000MHz
LQW18AN15NJ00□	15nH ±5%	100MHz	40	250MHz	600mA	0.13Ω	6000MHz
LQW18AN16NG00□	16nH ±2%	100MHz	40	250MHz	550mA	0.16Ω	5500MHz
LQW18AN16NJ00□	16nH ±5%	100MHz	40	250MHz	550mA	0.16Ω	5500MHz
LQW18AN18NG00□	18nH ±2%	100MHz	40	250MHz	550mA	0.16Ω	5500MHz
LQW18AN18NJ00□	18nH ±5%	100MHz	40	250MHz	550mA	0.16Ω	5500MHz
LQW18AN20NG00□	20nH ±2%	100MHz	40	250MHz	550mA	0.16Ω	4900MHz
LQW18AN20NJ00□	20nH ±5%	100MHz	40	250MHz	550mA	0.16Ω	4900MHz
LQW18AN22NG00□	22nH ±2%	100MHz	40	250MHz	500mA	0.17Ω	4600MHz
LQW18AN22NJ00□	22nH ±5%	100MHz	40	250MHz	500mA	0.17Ω	4600MHz
LQW18AN24NG00□	24nH ±2%	100MHz	40	250MHz	500mA	0.21Ω	3800MHz
LQW18AN24NJ00□	24nH ±5%	100MHz	40	250MHz	500mA	0.21Ω	3800MHz
LQW18AN27NG00□	27nH ±2%	100MHz	40	250MHz	440mA	0.21Ω	3700MHz
LQW18AN27NJ00□	27nH ±5%	100MHz	40	250MHz	440mA	0.21Ω	3700MHz
LQW18AN30NG00□	30nH ±2%	100MHz	40	250MHz	420mA	0.23Ω	3300MHz
LQW18AN30NJ00□	30nH ±5%	100MHz	40	250MHz	420mA	0.23Ω	3300MHz
LQW18AN33NG00□	33nH ±2%	100MHz	40	250MHz	420mA	0.23Ω	3200MHz
LQW18AN33NJ00□	33nH ±5%	100MHz	40	250MHz	420mA	0.23Ω	3200MHz
LQW18AN36NG00□	36nH ±2%	100MHz	40	250MHz	400mA	0.26Ω	2900MHz
LQW18AN36NJ00□	36nH ±5%	100MHz	40	250MHz	400mA	0.26Ω	2900MHz
LQW18AN39NG00□	39nH ±2%	100MHz	40	250MHz	400mA	0.26Ω	2800MHz
LQW18AN39NJ00□	39nH ±5%	100MHz	40	250MHz	400mA	0.26Ω	2800MHz

Operating temp. range: -55 to 125°C
 Only for reflow soldering
 *S.R.F.: Self Resonant Frequency

Continued on the following page. ↗

Continued from the preceding page. ↘

Part Number (□: packaging code)	Inductance	Inductance Test Frequency	Q (min.)	Q Test Frequency	Rated Current	Max. of DC Resistance	S.R.F.* (min.)
LQW18AN43NG00□	43nH ±2%	100MHz	40	200MHz	380mA	0.29Ω	2700MHz
LQW18AN43NJ00□	43nH ±5%	100MHz	40	200MHz	380mA	0.29Ω	2700MHz
LQW18AN47NG00□	47nH ±2%	100MHz	38	200MHz	380mA	0.29Ω	2600MHz
LQW18AN47NJ00□	47nH ±5%	100MHz	38	200MHz	380mA	0.29Ω	2600MHz
LQW18AN51NG00□	51nH ±2%	100MHz	38	200MHz	370mA	0.33Ω	2500MHz
LQW18AN51NJ00□	51nH ±5%	100MHz	38	200MHz	370mA	0.33Ω	2500MHz
LQW18AN56NG00□	56nH ±2%	100MHz	38	200MHz	360mA	0.35Ω	2400MHz
LQW18AN56NJ00□	56nH ±5%	100MHz	38	200MHz	360mA	0.35Ω	2400MHz
LQW18AN62NG00□	62nH ±2%	100MHz	38	200MHz	280mA	0.51Ω	2300MHz
LQW18AN62NJ00□	62nH ±5%	100MHz	38	200MHz	280mA	0.51Ω	2300MHz
LQW18AN68NG00□	68nH ±2%	100MHz	38	200MHz	340mA	0.38Ω	2200MHz
LQW18AN68NJ00□	68nH ±5%	100MHz	38	200MHz	340mA	0.38Ω	2200MHz
LQW18AN72NG00□	72nH ±2%	100MHz	34	150MHz	270mA	0.56Ω	2100MHz
LQW18AN72NJ00□	72nH ±5%	100MHz	34	150MHz	270mA	0.56Ω	2100MHz
LQW18AN75NG00□	75nH ±2%	100MHz	34	150MHz	270mA	0.56Ω	2050MHz
LQW18AN75NJ00□	75nH ±5%	100MHz	34	150MHz	270mA	0.56Ω	2050MHz
LQW18AN82NG00□	82nH ±2%	100MHz	34	150MHz	250mA	0.60Ω	2000MHz
LQW18AN82NJ00□	82nH ±5%	100MHz	34	150MHz	250mA	0.60Ω	2000MHz
LQW18AN91NG00□	91nH ±2%	100MHz	34	150MHz	230mA	0.64Ω	1900MHz
LQW18AN91NJ00□	91nH ±5%	100MHz	34	150MHz	230mA	0.64Ω	1900MHz
LQW18ANR10G00□	100nH ±2%	100MHz	34	150MHz	220mA	0.68Ω	1800MHz
LQW18ANR10J00□	100nH ±5%	100MHz	34	150MHz	220mA	0.68Ω	1800MHz
LQW18ANR11G00□	110nH ±2%	100MHz	32	150MHz	200mA	1.2Ω	1700MHz
LQW18ANR11J00□	110nH ±5%	100MHz	32	150MHz	200mA	1.2Ω	1700MHz
LQW18ANR12G00□	120nH ±2%	100MHz	32	150MHz	180mA	1.3Ω	1600MHz
LQW18ANR12J00□	120nH ±5%	100MHz	32	150MHz	180mA	1.3Ω	1600MHz
LQW18ANR13G00□	130nH ±2%	100MHz	32	150MHz	170mA	1.4Ω	1450MHz
LQW18ANR13J00□	130nH ±5%	100MHz	32	150MHz	170mA	1.4Ω	1450MHz
LQW18ANR15G00□	150nH ±2%	100MHz	32	150MHz	160mA	1.5Ω	1400MHz
LQW18ANR15J00□	150nH ±5%	100MHz	32	150MHz	160mA	1.5Ω	1400MHz
LQW18ANR16G00□	160nH ±2%	100MHz	32	150MHz	150mA	2.1Ω	1350MHz
LQW18ANR16J00□	160nH ±5%	100MHz	32	150MHz	150mA	2.1Ω	1350MHz
LQW18ANR18G00□	180nH ±2%	100MHz	25	100MHz	140mA	2.2Ω	1300MHz
LQW18ANR18J00□	180nH ±5%	100MHz	25	100MHz	140mA	2.2Ω	1300MHz
LQW18ANR20G00□	200nH ±2%	100MHz	25	100MHz	120mA	2.4Ω	1250MHz
LQW18ANR20J00□	200nH ±5%	100MHz	25	100MHz	120mA	2.4Ω	1250MHz
LQW18ANR22G00□	220nH ±2%	100MHz	25	100MHz	120mA	2.5Ω	1200MHz
LQW18ANR22J00□	220nH ±5%	100MHz	25	100MHz	120mA	2.5Ω	1200MHz
LQW18ANR27G00□	270nH ±2%	100MHz	30	100MHz	110mA	3.4Ω	960MHz
LQW18ANR27J00□	270nH ±5%	100MHz	30	100MHz	110mA	3.4Ω	960MHz
LQW18ANR33G00□	330nH ±2%	100MHz	30	100MHz	85mA	5.5Ω	800MHz
LQW18ANR33J00□	330nH ±5%	100MHz	30	100MHz	85mA	5.5Ω	800MHz
LQW18ANR39G00□	390nH ±2%	100MHz	30	100MHz	80mA	6.2Ω	800MHz
LQW18ANR39J00□	390nH ±5%	100MHz	30	100MHz	80mA	6.2Ω	800MHz
LQW18ANR47G00□	470nH ±2%	100MHz	30	100MHz	75mA	7.0Ω	700MHz
LQW18ANR47J00□	470nH ±5%	100MHz	30	100MHz	75mA	7.0Ω	700MHz

Operating temp. range: -55 to 125°C

Only for reflow soldering

*S.R.F.: Self Resonant Frequency

Continued on the following page. ↗

Continued from the preceding page. ↘

Inductance-Frequency Characteristics (Typ.)



Q-Frequency Characteristics (Typ.)



LQW18AN_10 Series 0603 (1608) inch (mm)



Packaging Code	Packaging	Minimum Quantity
D	ø180mm Paper Taping	4000
J	ø330mm Paper Taping	10000
B	Packing in Bulk	500

Part Number (□: packaging code)	Inductance	Inductance Test Frequency	Q (min.)	Q Test Frequency	Rated Current	Max. of DC Resistance	S.R.F.* (min.)
LQW18AN2N2D10□	2.2nH ±0.5nH	100MHz	25	250MHz	1400mA	0.018Ω	18000MHz
LQW18AN3N9C10□	3.9nH ±0.2nH	100MHz	38	250MHz	1000mA	0.032Ω	11000MHz
LQW18AN3N9D10□	3.9nH ±0.5nH	100MHz	38	250MHz	1000mA	0.032Ω	11000MHz
LQW18AN5N6D10□	5.6nH ±0.5nH	100MHz	38	250MHz	900mA	0.045Ω	10000MHz
LQW18AN6N8C10□	6.8nH ±0.2nH	100MHz	38	250MHz	900mA	0.045Ω	7000MHz
LQW18AN6N8D10□	6.8nH ±0.5nH	100MHz	38	250MHz	900mA	0.045Ω	7000MHz
LQW18AN8N2D10□	8.2nH ±0.5nH	100MHz	38	250MHz	800mA	0.058Ω	7000MHz
LQW18AN10NG10□	10nH ±2%	100MHz	38	250MHz	800mA	0.058Ω	5000MHz
LQW18AN10NJ10□	10nH ±5%	100MHz	38	250MHz	800mA	0.058Ω	5000MHz
LQW18AN12NG10□	12nH ±2%	100MHz	38	250MHz	750mA	0.071Ω	5000MHz
LQW18AN12NJ10□	12nH ±5%	100MHz	38	250MHz	750mA	0.071Ω	5000MHz
LQW18AN15NJ10□	15nH ±5%	100MHz	42	250MHz	700mA	0.085Ω	4500MHz
LQW18AN18NG10□	18nH ±2%	100MHz	42	250MHz	700mA	0.085Ω	3500MHz
LQW18AN18NJ10□	18nH ±5%	100MHz	42	250MHz	700mA	0.085Ω	3500MHz
LQW18AN22NG10□	22nH ±2%	100MHz	42	250MHz	640mA	0.099Ω	3200MHz
LQW18AN22NJ10□	22nH ±5%	100MHz	42	250MHz	640mA	0.099Ω	3200MHz
LQW18AN27NG10□	27nH ±2%	100MHz	42	250MHz	590mA	0.116Ω	2800MHz
LQW18AN27NJ10□	27nH ±5%	100MHz	42	250MHz	590mA	0.116Ω	2800MHz
LQW18AN33NJ10□	33nH ±5%	100MHz	42	250MHz	550mA	0.132Ω	2500MHz

Operating temp. range: -55 to 125°C
 Only for reflow soldering
 *S.R.F.: Self Resonant Frequency

Continued on the following page. ↗

Continued from the preceding page. ↘

Inductance-Frequency Characteristics (Typ.)



Q-Frequency Characteristics (Typ.)



LQW18AN_80 Series 0603 (1608) inch (mm)



Packaging Code	Packaging	Minimum Quantity
D	ø180mm Paper Taping	4000
J	ø330mm Paper Taping	10000
B	Packing in Bulk	500

Part Number (□: packaging code)	Inductance	Inductance Test Frequency	Q (min.)	Q Test Frequency	Rated Current	Max. of DC Resistance	S.R.F.* (min.)
LQW18AN2N2C80□	2.2nH ±0.2nH	100MHz	24	250MHz	3200mA	0.018Ω	15000MHz
LQW18AN2N4C80□	2.4nH ±0.2nH	100MHz	18	250MHz	2400mA	0.026Ω	15000MHz
LQW18AN3N0C80□	3.0nH ±0.2nH	100MHz	13	250MHz	670mA	0.17Ω	15000MHz
LQW18AN3N9B80□	3.9nH ±0.1nH	100MHz	30	250MHz	2200mA	0.028Ω	10000MHz
LQW18AN3N9C80□	3.9nH ±0.2nH	100MHz	30	250MHz	2200mA	0.028Ω	10000MHz
LQW18AN3N9G80□	3.9nH ±2%	100MHz	30	250MHz	2200mA	0.028Ω	10000MHz
LQW18AN4N1B80□	4.1nH ±0.1nH	100MHz	30	250MHz	2200mA	0.028Ω	10000MHz
LQW18AN4N1C80□	4.1nH ±0.2nH	100MHz	30	250MHz	2200mA	0.028Ω	10000MHz
LQW18AN4N1G80□	4.1nH ±2%	100MHz	30	250MHz	2200mA	0.028Ω	10000MHz
LQW18AN4N2B80□	4.2nH ±0.1nH	100MHz	30	250MHz	2200mA	0.028Ω	10000MHz
LQW18AN4N2C80□	4.2nH ±0.2nH	100MHz	30	250MHz	2200mA	0.028Ω	10000MHz
LQW18AN4N2G80□	4.2nH ±2%	100MHz	30	250MHz	2200mA	0.028Ω	10000MHz
LQW18AN4N3B80□	4.3nH ±0.1nH	100MHz	35	250MHz	2100mA	0.036Ω	11600MHz
LQW18AN4N3C80□	4.3nH ±0.2nH	100MHz	35	250MHz	2100mA	0.036Ω	11600MHz
LQW18AN4N3G80□	4.3nH ±2%	100MHz	35	250MHz	2100mA	0.036Ω	11600MHz
LQW18AN4N7B80□	4.7nH ±0.1nH	100MHz	25	250MHz	1500mA	0.054Ω	10400MHz
LQW18AN4N7C80□	4.7nH ±0.2nH	100MHz	25	250MHz	1500mA	0.054Ω	10400MHz
LQW18AN4N7G80□	4.7nH ±2%	100MHz	25	250MHz	1500mA	0.054Ω	10400MHz
LQW18AN4N9B80□	4.9nH ±0.1nH	100MHz	23	250MHz	1200mA	0.081Ω	7300MHz
LQW18AN4N9C80□	4.9nH ±0.2nH	100MHz	23	250MHz	1200mA	0.081Ω	7300MHz
LQW18AN4N9G80□	4.9nH ±2%	100MHz	23	250MHz	1200mA	0.081Ω	7300MHz
LQW18AN5N6C80□	5.6nH ±0.2nH	100MHz	38	250MHz	1900mA	0.04Ω	6650MHz
LQW18AN5N6G80□	5.6nH ±2%	100MHz	38	250MHz	1900mA	0.040Ω	6650MHz
LQW18AN6N0C80□	6.0nH ±0.2nH	100MHz	40	250MHz	1900mA	0.04Ω	6650MHz

Operating temp. range: -55 to 125°C
 Only for reflow soldering

*S.R.F.: Self Resonant Frequency

In operating temperatures exceeding +85°C, derating of current is necessary for the LQW18AN_80 series. Please apply the derating curve shown in the chart according to the operating temperature. Please consider "Notice (Rating)."

Continued on the following page. ↗

Continued from the preceding page. ↘

Part Number (□: packaging code)	Inductance	Inductance Test Frequency	Q (min.)	Q Test Frequency	Rated Current	Max. of DC Resistance	S.R.F.* (min.)
LQW18AN6NOG80□	6nH ±2%	100MHz	40	250MHz	1900mA	0.040Ω	6650MHz
LQW18AN6N5C80□	6.5nH ±0.2nH	100MHz	40	250MHz	1900mA	0.04Ω	6650MHz
LQW18AN6N5G80□	6.5nH ±2%	100MHz	40	250MHz	1900mA	0.040Ω	6650MHz
LQW18AN6N8C80□	6.8nH ±0.2nH	100MHz	40	250MHz	1900mA	0.04Ω	6650MHz
LQW18AN6N8G80□	6.8nH ±2%	100MHz	40	250MHz	1900mA	0.040Ω	6650MHz
LQW18AN7N2C80□	7.2nH ±0.2nH	100MHz	38	250MHz	1900mA	0.04Ω	6650MHz
LQW18AN7N2G80□	7.2nH ±2%	100MHz	38	250MHz	1900mA	0.040Ω	6650MHz
LQW18AN7N5C80□	7.5nH ±0.2nH	100MHz	35	250MHz	1500mA	0.048Ω	7000MHz
LQW18AN7N5G80□	7.5nH ±2%	100MHz	35	250MHz	1500mA	0.048Ω	7000MHz
LQW18AN8N2C80□	8.2nH ±0.2nH	100MHz	38	250MHz	1600mA	0.052Ω	4750MHz
LQW18AN8N2G80□	8.2nH ±2%	100MHz	38	250MHz	1600mA	0.052Ω	4750MHz
LQW18AN8N4C80□	8.4nH ±0.2nH	100MHz	38	250MHz	1600mA	0.052Ω	4750MHz
LQW18AN8N4G80□	8.4nH ±2%	100MHz	38	250MHz	1600mA	0.052Ω	4750MHz
LQW18AN8N7C80□	8.7nH ±0.2nH	100MHz	38	250MHz	1600mA	0.052Ω	4750MHz
LQW18AN8N7G80□	8.7nH ±2%	100MHz	38	250MHz	1600mA	0.052Ω	4750MHz
LQW18AN9N1C80□	9.1nH ±0.2nH	100MHz	38	250MHz	1600mA	0.052Ω	4750MHz
LQW18AN9N1G80□	9.1nH ±2%	100MHz	38	250MHz	1600mA	0.052Ω	4750MHz
LQW18AN9N5C80□	9.5nH ±0.2nH	100MHz	38	250MHz	1600mA	0.052Ω	4750MHz
LQW18AN9N5G80□	9.5nH ±2%	100MHz	38	250MHz	1600mA	0.052Ω	4750MHz
LQW18AN9N9C80□	9.9nH ±0.2nH	100MHz	38	250MHz	1600mA	0.052Ω	4750MHz
LQW18AN9N9G80□	9.9nH ±2%	100MHz	38	250MHz	1600mA	0.052Ω	4750MHz
LQW18AN10NG80□	10nH ±2%	100MHz	38	250MHz	1600mA	0.052Ω	4750MHz
LQW18AN10NJ80□	10nH ±5%	100MHz	38	250MHz	1600mA	0.052Ω	4750MHz
LQW18AN11NG80□	11nH ±2%	100MHz	40	250MHz	1600mA	0.052Ω	4750MHz
LQW18AN11NJ80□	11nH ±5%	100MHz	40	250MHz	1600mA	0.052Ω	4750MHz
LQW18AN12NG80□	12nH ±2%	100MHz	37	250MHz	1500mA	0.064Ω	5000MHz
LQW18AN12NJ80□	12nH ±5%	100MHz	37	250MHz	1500mA	0.064Ω	5000MHz
LQW18AN13NG80□	13nH ±2%	100MHz	37	250MHz	1500mA	0.064Ω	5000MHz
LQW18AN13NJ80□	13nH ±5%	100MHz	37	250MHz	1500mA	0.064Ω	5000MHz
LQW18AN15NG80□	15nH ±2%	100MHz	38	250MHz	1400mA	0.075Ω	4600MHz
LQW18AN15NJ80□	15nH ±5%	100MHz	38	250MHz	1400mA	0.075Ω	4600MHz
LQW18AN16NG80□	16nH ±2%	100MHz	40	250MHz	1400mA	0.075Ω	4600MHz
LQW18AN16NJ80□	16nH ±5%	100MHz	40	250MHz	1400mA	0.075Ω	4600MHz
LQW18AN17NG80□	17nH ±2%	100MHz	40	250MHz	1400mA	0.075Ω	4600MHz
LQW18AN17NJ80□	17nH ±5%	100MHz	40	250MHz	1400mA	0.075Ω	4600MHz
LQW18AN18NG80□	18nH ±2%	100MHz	40	250MHz	1400mA	0.075Ω	4600MHz
LQW18AN18NJ80□	18nH ±5%	100MHz	40	250MHz	1400mA	0.075Ω	4600MHz
LQW18AN19NG80□	19nH ±2%	100MHz	40	250MHz	1400mA	0.075Ω	4600MHz
LQW18AN19NJ80□	19nH ±5%	100MHz	40	250MHz	1400mA	0.075Ω	4600MHz
LQW18AN22NG80□	22nH ±2%	100MHz	40	250MHz	1300mA	0.086Ω	3450MHz
LQW18AN22NJ80□	22nH ±5%	100MHz	40	250MHz	1300mA	0.086Ω	3450MHz
LQW18AN23NG80□	23nH ±2%	100MHz	40	250MHz	1300mA	0.086Ω	3450MHz
LQW18AN23NJ80□	23nH ±5%	100MHz	40	250MHz	1300mA	0.086Ω	3450MHz
LQW18AN24NG80□	24nH ±2%	100MHz	40	250MHz	1300mA	0.086Ω	3450MHz
LQW18AN24NJ80□	24nH ±5%	100MHz	40	250MHz	1300mA	0.086Ω	3450MHz
LQW18AN25NG80□	25nH ±2%	100MHz	40	250MHz	1200mA	0.098Ω	3600MHz
LQW18AN25NJ80□	25nH ±5%	100MHz	40	250MHz	1200mA	0.098Ω	3600MHz
LQW18AN27NG80□	27nH ±2%	100MHz	40	250MHz	1200mA	0.098Ω	3600MHz
LQW18AN27NJ80□	27nH ±5%	100MHz	40	250MHz	1200mA	0.098Ω	3600MHz
LQW18AN28NG80□	28nH ±2%	100MHz	40	250MHz	1200mA	0.098Ω	3600MHz
LQW18AN28NJ80□	28nH ±5%	100MHz	40	250MHz	1200mA	0.098Ω	3600MHz

Operating temp. range: -55 to 125°C

Only for reflow soldering

*S.R.F.: Self Resonant Frequency

In operating temperatures exceeding +85°C, derating of current is necessary for the LQW18AN_80 series. Please apply the derating curve shown in the chart according to the operating temperature. Please consider "Notice (Rating)."

Continued on the following page. ↗

Continued from the preceding page. ↘

Part Number (□: packaging code)	Inductance	Inductance Test Frequency	Q (min.)	Q Test Frequency	Rated Current	Max. of DC Resistance	S.R.F.* (min.)
LQW18AN30NG80□	30nH ±2%	100MHz	40	250MHz	1100mA	0.12Ω	2880MHz
LQW18AN30NJ80□	30nH ±5%	100MHz	40	250MHz	1100mA	0.12Ω	2880MHz
LQW18AN31NG80□	31nH ±2%	100MHz	40	250MHz	1100mA	0.11Ω	3150MHz
LQW18AN31NJ80□	31nH ±5%	100MHz	40	250MHz	1100mA	0.11Ω	3150MHz
LQW18AN33NG80□	33nH ±2%	100MHz	40	250MHz	1100mA	0.11Ω	3150MHz
LQW18AN33NJ80□	33nH ±5%	100MHz	40	250MHz	1100mA	0.11Ω	3150MHz
LQW18AN34NG80□	34nH ±2%	100MHz	40	250MHz	1050mA	0.15Ω	3000MHz
LQW18AN34NJ80□	34nH ±5%	100MHz	40	250MHz	1050mA	0.15Ω	3000MHz
LQW18AN36NG80□	36nH ±2%	100MHz	37	250MHz	910mA	0.20Ω	3000MHz
LQW18AN36NJ80□	36nH ±5%	100MHz	37	250MHz	910mA	0.20Ω	3000MHz
LQW18AN37NG80□	37nH ±2%	100MHz	37	250MHz	910mA	0.20Ω	3000MHz
LQW18AN37NJ80□	37nH ±5%	100MHz	37	250MHz	910mA	0.20Ω	3000MHz
LQW18AN39NG80□	39nH ±2%	100MHz	40	250MHz	1000mA	0.16Ω	3280MHz
LQW18AN39NJ80□	39nH ±5%	100MHz	40	250MHz	1000mA	0.16Ω	3280MHz
LQW18AN41NG80□	41nH ±2%	100MHz	40	250MHz	1000mA	0.16Ω	3280MHz
LQW18AN41NJ80□	41nH ±5%	100MHz	40	250MHz	1000mA	0.16Ω	3280MHz
LQW18AN43NG80□	43nH ±2%	100MHz	40	250MHz	840mA	0.21Ω	2780MHz
LQW18AN43NJ80□	43nH ±5%	100MHz	40	250MHz	840mA	0.21Ω	2780MHz
LQW18AN44NG80□	44nH ±2%	100MHz	40	250MHz	840mA	0.21Ω	2780MHz
LQW18AN44NJ80□	44nH ±5%	100MHz	40	250MHz	840mA	0.21Ω	2780MHz
LQW18AN47NG80□	47nH ±2%	100MHz	32	200MHz	830mA	0.23Ω	2700MHz
LQW18AN47NJ80□	47nH ±5%	100MHz	32	200MHz	830mA	0.23Ω	2700MHz
LQW18AN48NG80□	48nH ±2%	100MHz	32	200MHz	830mA	0.23Ω	2700MHz
LQW18AN48NJ80□	48nH ±5%	100MHz	32	200MHz	830mA	0.23Ω	2700MHz
LQW18AN51NG80□	51nH ±2%	100MHz	32	200MHz	830mA	0.23Ω	2700MHz
LQW18AN51NJ80□	51nH ±5%	100MHz	32	200MHz	830mA	0.23Ω	2700MHz
LQW18AN52NG80□	52nH ±2%	100MHz	35	200MHz	750mA	0.27Ω	2750MHz
LQW18AN52NJ80□	52nH ±5%	100MHz	35	200MHz	750mA	0.27Ω	2750MHz
LQW18AN56NG80□	56nH ±2%	100MHz	38	200MHz	770mA	0.26Ω	2600MHz
LQW18AN56NJ80□	56nH ±5%	100MHz	38	200MHz	770mA	0.26Ω	2600MHz
LQW18AN58NG80□	58nH ±2%	100MHz	35	200MHz	700mA	0.30Ω	2400MHz
LQW18AN58NJ80□	58nH ±5%	100MHz	35	200MHz	700mA	0.30Ω	2400MHz
LQW18AN68NG80□	68nH ±2%	100MHz	37	200MHz	630mA	0.38Ω	2380MHz
LQW18AN68NJ80□	68nH ±5%	100MHz	37	200MHz	630mA	0.38Ω	2380MHz
LQW18AN69NG80□	69nH ±2%	100MHz	37	200MHz	630mA	0.38Ω	2380MHz
LQW18AN69NJ80□	69nH ±5%	100MHz	37	200MHz	630mA	0.38Ω	2380MHz
LQW18AN72NG80□	72nH ±2%	100MHz	34	150MHz	560mA	0.47Ω	2330MHz
LQW18AN72NJ80□	72nH ±5%	100MHz	34	150MHz	560mA	0.47Ω	2330MHz
LQW18AN73NG80□	73nH ±2%	100MHz	28	150MHz	590mA	0.41Ω	2280MHz
LQW18AN73NJ80□	73nH ±5%	100MHz	28	150MHz	590mA	0.41Ω	2280MHz
LQW18AN75NG80□	75nH ±2%	100MHz	28	150MHz	590mA	0.41Ω	2280MHz
LQW18AN75NJ80□	75nH ±5%	100MHz	28	150MHz	590mA	0.41Ω	2280MHz
LQW18AN78NG80□	78nH ±2%	100MHz	28	150MHz	590mA	0.41Ω	2280MHz
LQW18AN78NJ80□	78nH ±5%	100MHz	28	150MHz	590mA	0.41Ω	2280MHz
LQW18AN82NG80□	82nH ±2%	100MHz	34	150MHz	550mA	0.5Ω	2230MHz
LQW18AN82NJ80□	82nH ±5%	100MHz	34	150MHz	550mA	0.5Ω	2230MHz
LQW18AN83NG80□	83nH ±2%	100MHz	34	150MHz	550mA	0.5Ω	2230MHz
LQW18AN83NJ80□	83nH ±5%	100MHz	34	150MHz	550mA	0.5Ω	2230MHz
LQW18AN91NG80□	91nH ±2%	100MHz	33	150MHz	520mA	0.54Ω	1900MHz
LQW18AN91NJ80□	91nH ±5%	100MHz	33	150MHz	520mA	0.54Ω	1900MHz
LQW18AN94NG80□	94nH ±2%	100MHz	34	150MHz	490mA	0.63Ω	1750MHz

Operating temp. range: -55 to 125°C

Only for reflow soldering

*S.R.F.: Self Resonant Frequency

In operating temperatures exceeding +85°C, derating of current is necessary for the LQW18AN_80 series. Please apply the derating curve shown in the chart according to the operating temperature. Please consider "Notice (Rating)."

Continued on the following page. ↗

Continued from the preceding page. ↘

Part Number (□: packaging code)	Inductance	Inductance Test Frequency	Q (min.)	Q Test Frequency	Rated Current	Max. of DC Resistance	S.R.F.* (min.)
LQW18AN94NJ80□	94nH ±5%	100MHz	34	150MHz	490mA	0.63Ω	1750MHz
LQW18ANR10G80□	100nH ±2%	100MHz	34	150MHz	490mA	0.63Ω	1750MHz
LQW18ANR10J80□	100nH ±5%	100MHz	34	150MHz	490mA	0.63Ω	1750MHz
LQW18ANR11G80□	110nH ±2%	100MHz	32	150MHz	450mA	0.7Ω	1730MHz
LQW18ANR11J80□	110nH ±5%	100MHz	32	150MHz	450mA	0.7Ω	1730MHz
LQW18ANR12G80□	120nH ±2%	100MHz	32	150MHz	450mA	0.72Ω	1650MHz
LQW18ANR12J80□	120nH ±5%	100MHz	32	150MHz	450mA	0.72Ω	1650MHz
LQW18ANR15G80□	150nH ±2%	100MHz	28	150MHz	420mA	0.87Ω	1580MHz
LQW18ANR15J80□	150nH ±5%	100MHz	28	150MHz	420mA	0.87Ω	1580MHz
LQW18ANR18G80□	180nH ±2%	100MHz	25	100MHz	310mA	1.65Ω	1380MHz
LQW18ANR18J80□	180nH ±5%	100MHz	25	100MHz	310mA	1.65Ω	1380MHz
LQW18ANR20G80□	200nH ±2%	100MHz	25	100MHz	290mA	1.74Ω	1350MHz
LQW18ANR20J80□	200nH ±5%	100MHz	25	100MHz	290mA	1.74Ω	1350MHz
LQW18ANR21G80□	210nH ±2%	100MHz	27	100MHz	280mA	1.98Ω	1330MHz
LQW18ANR21J80□	210nH ±5%	100MHz	27	100MHz	280mA	1.98Ω	1330MHz
LQW18ANR22G80□	220nH ±2%	100MHz	25	100MHz	280mA	2.08Ω	1330MHz
LQW18ANR22J80□	220nH ±5%	100MHz	25	100MHz	280mA	2.08Ω	1330MHz
LQW18ANR25G80□	250nH ±2%	100MHz	24	100MHz	250mA	2.28Ω	1330MHz
LQW18ANR25J80□	250nH ±5%	100MHz	24	100MHz	250mA	2.28Ω	1330MHz
LQW18ANR27G80□	270nH ±2%	100MHz	24	100MHz	260mA	2.42Ω	1250MHz
LQW18ANR27J80□	270nH ±5%	100MHz	24	100MHz	260mA	2.42Ω	1250MHz
LQW18ANR30G80□	300nH ±2%	100MHz	25	100MHz	220mA	3.12Ω	1200MHz
LQW18ANR30J80□	300nH ±5%	100MHz	25	100MHz	220mA	3.12Ω	1200MHz
LQW18ANR33G80□	330nH ±2%	100MHz	25	100MHz	190mA	3.84Ω	1100MHz
LQW18ANR33J80□	330nH ±5%	100MHz	25	100MHz	190mA	3.84Ω	1100MHz
LQW18ANR36G80□	360nH ±2%	100MHz	25	100MHz	190mA	3.98Ω	1050MHz
LQW18ANR36J80□	360nH ±5%	100MHz	25	100MHz	190mA	3.98Ω	1050MHz
LQW18ANR39G80□	390nH ±2%	100MHz	25	100MHz	190mA	4.23Ω	1100MHz
LQW18ANR39J80□	390nH ±5%	100MHz	25	100MHz	190mA	4.23Ω	1100MHz

Operating temp. range: -55 to 125°C

Only for reflow soldering

*S.R.F.: Self Resonant Frequency

In operating temperatures exceeding +85°C, derating of current is necessary for the LQW18AN_80 series. Please apply the derating curve shown in the chart according to the operating temperature. Please consider "Notice (Rating)."

Inductance-Frequency Characteristics (Typ.)



Q-Frequency Characteristics (Typ.)



Notice (Rating)

In operating temperatures exceeding +85°C, derating of current is necessary for this series.

Please apply the derating curve shown in the chart according to the operating temperature.

Derating of Rated Current



LQW18AS_00 Series 0603 (1608) inch (mm)



Packaging Code	Packaging	Minimum Quantity
D	ø180mm Paper Taping	4000
J	ø330mm Paper Taping	10000
B	Packing in Bulk	500

Part Number (□: packaging code)	Inductance	Inductance Test Frequency	Q (min.)	Q Test Frequency	Rated Current	Max. of DC Resistance	S.R.F.* (min.)
LQW18AS1N6J00□	1.6nH ±5%	250MHz	24	250MHz	700mA	0.030Ω	12500MHz
LQW18AS1N8J00□	1.8nH ±5%	250MHz	16	250MHz	700mA	0.045Ω	12500MHz
LQW18AS3N3G00□	3.3nH ±2%	250MHz	35	250MHz	700mA	0.045Ω	5900MHz
LQW18AS3N3J00□	3.3nH ±5%	250MHz	35	250MHz	700mA	0.045Ω	5900MHz
LQW18AS3N6G00□	3.6nH ±2%	250MHz	22	250MHz	700mA	0.063Ω	5900MHz
LQW18AS3N6J00□	3.6nH ±5%	250MHz	22	250MHz	700mA	0.063Ω	5900MHz
LQW18AS3N9G00□	3.9nH ±2%	250MHz	22	250MHz	700mA	0.080Ω	6900MHz
LQW18AS3N9J00□	3.9nH ±5%	250MHz	22	250MHz	700mA	0.080Ω	6900MHz
LQW18AS4N3G00□	4.3nH ±2%	250MHz	22	250MHz	700mA	0.063Ω	5900MHz
LQW18AS4N3J00□	4.3nH ±5%	250MHz	22	250MHz	700mA	0.063Ω	5900MHz
LQW18AS4N7G00□	4.7nH ±2%	250MHz	20	250MHz	700mA	0.116Ω	5800MHz
LQW18AS4N7J00□	4.7nH ±5%	250MHz	20	250MHz	700mA	0.116Ω	5800MHz
LQW18AS5N1G00□	5.1nH ±2%	250MHz	20	250MHz	700mA	0.140Ω	5700MHz
LQW18AS5N1J00□	5.1nH ±5%	250MHz	20	250MHz	700mA	0.140Ω	5700MHz
LQW18AS5N6G00□	5.6nH ±2%	250MHz	26	250MHz	700mA	0.075Ω	4760MHz
LQW18AS5N6J00□	5.6nH ±5%	250MHz	26	250MHz	700mA	0.075Ω	4760MHz
LQW18AS6N8G00□	6.8nH ±2%	250MHz	27	250MHz	700mA	0.110Ω	5800MHz
LQW18AS6N8J00□	6.8nH ±5%	250MHz	27	250MHz	700mA	0.110Ω	5800MHz
LQW18AS7N5G00□	7.5nH ±2%	250MHz	28	250MHz	700mA	0.106Ω	4800MHz
LQW18AS7N5J00□	7.5nH ±5%	250MHz	28	250MHz	700mA	0.106Ω	4800MHz
LQW18AS8N2G00□	8.2nH ±2%	250MHz	30	250MHz	700mA	0.115Ω	4200MHz
LQW18AS8N2J00□	8.2nH ±5%	250MHz	30	250MHz	700mA	0.115Ω	4200MHz
LQW18AS8N7G00□	8.7nH ±2%	250MHz	28	250MHz	700mA	0.109Ω	4600MHz
LQW18AS8N7J00□	8.7nH ±5%	250MHz	28	250MHz	700mA	0.109Ω	4600MHz
LQW18AS9N5G00□	9.5nH ±2%	250MHz	28	250MHz	700mA	0.135Ω	5400MHz
LQW18AS9N5J00□	9.5nH ±5%	250MHz	28	250MHz	700mA	0.135Ω	5400MHz
LQW18AS10NG00□	10nH ±2%	250MHz	31	250MHz	700mA	0.130Ω	4800MHz
LQW18AS10NJ00□	10nH ±5%	250MHz	31	250MHz	700mA	0.130Ω	4800MHz
LQW18AS11NG00□	11nH ±2%	250MHz	30	250MHz	700mA	0.086Ω	4000MHz
LQW18AS11NJ00□	11nH ±5%	250MHz	30	250MHz	700mA	0.086Ω	4000MHz
LQW18AS12NG00□	12nH ±2%	250MHz	35	250MHz	700mA	0.130Ω	4000MHz
LQW18AS12NJ00□	12nH ±5%	250MHz	35	250MHz	700mA	0.130Ω	4000MHz
LQW18AS15NG00□	15nH ±2%	250MHz	35	250MHz	700mA	0.170Ω	4000MHz
LQW18AS15NJ00□	15nH ±5%	250MHz	35	250MHz	700mA	0.170Ω	4000MHz
LQW18AS16NG00□	16nH ±2%	250MHz	34	250MHz	700mA	0.104Ω	3300MHz
LQW18AS16NJ00□	16nH ±5%	250MHz	34	250MHz	700mA	0.104Ω	3300MHz
LQW18AS18NG00□	18nH ±2%	250MHz	35	250MHz	700mA	0.170Ω	3100MHz
LQW18AS18NJ00□	18nH ±5%	250MHz	35	250MHz	700mA	0.170Ω	3100MHz
LQW18AS22NG00□	22nH ±2%	250MHz	38	250MHz	700mA	0.190Ω	3000MHz
LQW18AS22NJ00□	22nH ±5%	250MHz	38	250MHz	700mA	0.190Ω	3000MHz

Operating temp. range (Self-temp. rise included): -40 to 125°C

Only for reflow soldering

*S.R.F.: Self Resonant Frequency

Continued on the following page. ↗

Continued from the preceding page. ↘

Part Number (□: packaging code)	Inductance	Inductance Test Frequency	Q (min.)	Q Test Frequency	Rated Current	Max. of DC Resistance	S.R.F.* (min.)
LQW18AS23NG00□	23nH ±2%	250MHz	38	250MHz	700mA	0.190Ω	2850MHz
LQW18AS23NJ00□	23nH ±5%	250MHz	38	250MHz	700mA	0.190Ω	2850MHz
LQW18AS24NG00□	24nH ±2%	250MHz	36	250MHz	700mA	0.135Ω	2650MHz
LQW18AS24NJ00□	24nH ±5%	250MHz	36	250MHz	700mA	0.135Ω	2650MHz
LQW18AS27NG00□	27nH ±2%	250MHz	40	250MHz	600mA	0.220Ω	2800MHz
LQW18AS27NJ00□	27nH ±5%	250MHz	40	250MHz	600mA	0.220Ω	2800MHz
LQW18AS30NG00□	30nH ±2%	250MHz	37	250MHz	600mA	0.144Ω	2250MHz
LQW18AS30NJ00□	30nH ±5%	250MHz	37	250MHz	600mA	0.144Ω	2250MHz
LQW18AS33NG00□	33nH ±2%	250MHz	40	250MHz	600mA	0.220Ω	2300MHz
LQW18AS33NJ00□	33nH ±5%	250MHz	40	250MHz	600mA	0.220Ω	2300MHz
LQW18AS36NG00□	36nH ±2%	250MHz	37	250MHz	600mA	0.250Ω	2080MHz
LQW18AS36NJ00□	36nH ±5%	250MHz	37	250MHz	600mA	0.250Ω	2080MHz
LQW18AS39NG00□	39nH ±2%	250MHz	40	250MHz	600mA	0.250Ω	2200MHz
LQW18AS39NJ00□	39nH ±5%	250MHz	40	250MHz	600mA	0.250Ω	2200MHz
LQW18AS43NG00□	43nH ±2%	250MHz	38	250MHz	600mA	0.280Ω	2000MHz
LQW18AS43NJ00□	43nH ±5%	250MHz	38	250MHz	600mA	0.280Ω	2000MHz
LQW18AS47NG00□	47nH ±2%	200MHz	38	200MHz	600mA	0.280Ω	2000MHz
LQW18AS47NJ00□	47nH ±5%	200MHz	38	200MHz	600mA	0.280Ω	2000MHz
LQW18AS51NG00□	51nH ±2%	200MHz	35	200MHz	600mA	0.270Ω	1900MHz
LQW18AS51NJ00□	51nH ±5%	200MHz	35	200MHz	600mA	0.270Ω	1900MHz
LQW18AS56NG00□	56nH ±2%	200MHz	38	200MHz	600mA	0.310Ω	1900MHz
LQW18AS56NJ00□	56nH ±5%	200MHz	38	200MHz	600mA	0.310Ω	1900MHz
LQW18AS68NG00□	68nH ±2%	200MHz	37	200MHz	600mA	0.340Ω	1700MHz
LQW18AS68NJ00□	68nH ±5%	200MHz	37	200MHz	600mA	0.340Ω	1700MHz
LQW18AS72NG00□	72nH ±2%	150MHz	34	150MHz	400mA	0.490Ω	1700MHz
LQW18AS72NJ00□	72nH ±5%	150MHz	34	150MHz	400mA	0.490Ω	1700MHz
LQW18AS82NG00□	82nH ±2%	150MHz	34	150MHz	400mA	0.540Ω	1700MHz
LQW18AS82NJ00□	82nH ±5%	150MHz	34	150MHz	400mA	0.540Ω	1700MHz
LQW18ASR10G00□	100nH ±2%	150MHz	34	150MHz	400mA	0.580Ω	1400MHz
LQW18ASR10J00□	100nH ±5%	150MHz	34	150MHz	400mA	0.580Ω	1400MHz
LQW18ASR11G00□	110nH ±2%	150MHz	32	150MHz	300mA	0.610Ω	1350MHz
LQW18ASR11J00□	110nH ±5%	150MHz	32	150MHz	300mA	0.610Ω	1350MHz
LQW18ASR12G00□	120nH ±2%	150MHz	32	150MHz	300mA	0.650Ω	1300MHz
LQW18ASR12J00□	120nH ±5%	150MHz	32	150MHz	300mA	0.650Ω	1300MHz
LQW18ASR15G00□	150nH ±2%	150MHz	28	150MHz	280mA	0.920Ω	990MHz
LQW18ASR15J00□	150nH ±5%	150MHz	28	150MHz	280mA	0.920Ω	990MHz
LQW18ASR18G00□	180nH ±2%	100MHz	25	100MHz	240mA	1.250Ω	990MHz
LQW18ASR18J00□	180nH ±5%	100MHz	25	100MHz	240mA	1.250Ω	990MHz
LQW18ASR20G00□	200nH ±2%	100MHz	25	100MHz	200mA	1.980Ω	900MHz
LQW18ASR20J00□	200nH ±5%	100MHz	25	100MHz	200mA	1.980Ω	900MHz
LQW18ASR21G00□	210nH ±2%	100MHz	27	100MHz	200mA	2.060Ω	895MHz
LQW18ASR21J00□	210nH ±5%	100MHz	27	100MHz	200mA	2.060Ω	895MHz
LQW18ASR22G00□	220nH ±2%	100MHz	25	100MHz	200mA	2.100Ω	900MHz
LQW18ASR22J00□	220nH ±5%	100MHz	25	100MHz	200mA	2.100Ω	900MHz
LQW18ASR25G00□	250nH ±2%	100MHz	25	100MHz	120mA	3.550Ω	822MHz
LQW18ASR25J00□	250nH ±5%	100MHz	25	100MHz	120mA	3.550Ω	822MHz
LQW18ASR27G00□	270nH ±2%	100MHz	24	100MHz	170mA	2.300Ω	900MHz
LQW18ASR27J00□	270nH ±5%	100MHz	24	100MHz	170mA	2.300Ω	900MHz
LQW18ASR33G00□	330nH ±2%	100MHz	25	100MHz	100mA	3.890Ω	900MHz
LQW18ASR33J00□	330nH ±5%	100MHz	25	100MHz	100mA	3.890Ω	900MHz
LQW18ASR39G00□	390nH ±2%	100MHz	25	100MHz	100mA	4.350Ω	900MHz
LQW18ASR39J00□	390nH ±5%	100MHz	25	100MHz	100mA	4.350Ω	900MHz

Operating temp. range (Self-temp. rise included): -40 to 125°C

Only for reflow soldering

*S.R.F.: Self Resonant Frequency

Continued on the following page. ↗

Continued from the preceding page. ↘

Inductance-Frequency Characteristics (Typ.)



Q-Frequency Characteristics (Typ.)



LQW18AS_0C Series 0603 (1608) inch (mm)



Packaging Code	Packaging	Minimum Quantity
D	ø180mm Paper Taping	4000
J	ø330mm Paper Taping	10000
B	Packing in Bulk	500

Part Number (□: packaging code)	Inductance	Inductance Test Frequency	Q (min.)	Q Test Frequency	Rated Current	Max. of DC Resistance	S.R.F.* (min.)
LQW18AS4N3G0C□	4.3nH ±2%	250MHz	22	250MHz	700mA	0.063Ω	5900MHz
LQW18AS4N3J0C□	4.3nH ±5%	250MHz	22	250MHz	700mA	0.063Ω	5900MHz
LQW18AS8N2G0C□	8.2nH ±2%	250MHz	30	250MHz	700mA	0.115Ω	4200MHz
LQW18AS8N2J0C□	8.2nH ±5%	250MHz	30	250MHz	700mA	0.115Ω	4200MHz
LQW18AS10NG0C□	10nH ±2%	250MHz	31	250MHz	700mA	0.13Ω	4800MHz
LQW18AS10NJ0C□	10nH ±5%	250MHz	31	250MHz	700mA	0.13Ω	4800MHz
LQW18AS11NG0C□	11nH ±2%	250MHz	30	250MHz	700mA	0.086Ω	4000MHz
LQW18AS11NJ0C□	11nH ±5%	250MHz	30	250MHz	700mA	0.086Ω	4000MHz
LQW18AS15NG0C□	15nH ±2%	250MHz	35	250MHz	700mA	0.17Ω	4000MHz
LQW18AS15NJ0C□	15nH ±5%	250MHz	35	250MHz	700mA	0.17Ω	4000MHz
LQW18AS16NG0C□	16nH ±2%	250MHz	34	250MHz	700mA	0.104Ω	3300MHz
LQW18AS16NJ0C□	16nH ±5%	250MHz	34	250MHz	700mA	0.104Ω	3300MHz
LQW18AS18NG0C□	18nH ±2%	250MHz	35	250MHz	700mA	0.17Ω	3100MHz
LQW18AS18NJ0C□	18nH ±5%	250MHz	35	250MHz	700mA	0.17Ω	3100MHz
LQW18AS22NG0C□	22nH ±2%	250MHz	38	250MHz	700mA	0.19Ω	3000MHz
LQW18AS22NJ0C□	22nH ±5%	250MHz	38	250MHz	700mA	0.19Ω	3000MHz
LQW18AS24NG0C□	24nH ±2%	250MHz	36	250MHz	700mA	0.135Ω	2650MHz
LQW18AS24NJ0C□	24nH ±5%	250MHz	36	250MHz	700mA	0.135Ω	2650MHz
LQW18AS33NG0C□	33nH ±2%	250MHz	40	250MHz	600mA	0.22Ω	2300MHz
LQW18AS33NJ0C□	33nH ±5%	250MHz	40	250MHz	600mA	0.22Ω	2300MHz
LQW18AS56NG0C□	56nH ±2%	200MHz	38	200MHz	600mA	0.31Ω	1900MHz
LQW18AS56NJ0C□	56nH ±5%	200MHz	38	200MHz	600mA	0.31Ω	1900MHz
LQW18AS68NG0C□	68nH ±2%	200MHz	37	200MHz	600mA	0.34Ω	1700MHz
LQW18AS68NJ0C□	68nH ±5%	200MHz	37	200MHz	600mA	0.34Ω	1700MHz
LQW18AS82NG0C□	82nH ±2%	150MHz	34	150MHz	400mA	0.54Ω	1700MHz
LQW18AS82NJ0C□	82nH ±5%	150MHz	34	150MHz	400mA	0.54Ω	1700MHz

Operating temp. range (Self-temp. rise included): -40 to 85°C

Only for reflow soldering

*S.R.F.: Self Resonant Frequency

Continued on the following page. ↗

Continued from the preceding page. ↘

Part Number (□: packaging code)	Inductance	Inductance Test Frequency	Q (min.)	Q Test Frequency	Rated Current	Max. of DC Resistance	S.R.F.* (min.)
LQW18ASR10G0C□	100nH ±2%	150MHz	34	150MHz	400mA	0.58Ω	1400MHz
LQW18ASR10J0C□	100nH ±5%	150MHz	34	150MHz	400mA	0.58Ω	1400MHz
LQW18ASR12G0C□	120nH ±2%	150MHz	32	150MHz	300mA	0.65Ω	1300MHz
LQW18ASR12J0C□	120nH ±5%	150MHz	32	150MHz	300mA	0.65Ω	1300MHz
LQW18ASR15G0C□	150nH ±2%	150MHz	28	150MHz	280mA	0.92Ω	990MHz
LQW18ASR15J0C□	150nH ±5%	150MHz	28	150MHz	280mA	0.92Ω	990MHz
LQW18ASR18G0C□	180nH ±2%	100MHz	25	100MHz	240mA	1.4Ω	990MHz
LQW18ASR18J0C□	180nH ±5%	100MHz	25	100MHz	240mA	1.4Ω	990MHz
LQW18ASR22G0C□	220nH ±2%	100MHz	25	100MHz	200mA	2.1Ω	900MHz
LQW18ASR22J0C□	220nH ±5%	100MHz	25	100MHz	200mA	2.1Ω	900MHz
LQW18ASR27G0C□	270nH ±2%	100MHz	24	100MHz	130mA	2.5Ω	900MHz
LQW18ASR27J0C□	270nH ±5%	100MHz	24	100MHz	130mA	2.5Ω	900MHz
LQW18ASR33G0C□	330nH ±2%	100MHz	25	100MHz	100mA	3.89Ω	900MHz
LQW18ASR33J0C□	330nH ±5%	100MHz	25	100MHz	100mA	3.89Ω	900MHz
LQW18ASR39G0C□	390nH ±2%	100MHz	25	100MHz	100mA	4.35Ω	900MHz
LQW18ASR39J0C□	390nH ±5%	100MHz	25	100MHz	100mA	4.35Ω	900MHz

Operating temp. range (Self-temp. rise included): -40 to 85°C

Only for reflow soldering

*S.R.F.: Self Resonant Frequency

Inductance-Frequency Characteristics (Typ.)



Q-Frequency Characteristics (Typ.)

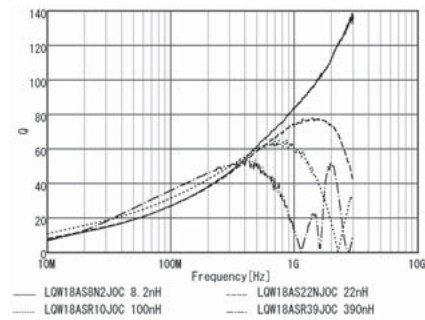

LQW2BAN_00 Series 0805 (2015) inch (mm)



Packaging Code	Packaging	Minimum Quantity
K	ø330mm Embossed Taping	8000
L	ø180mm Embossed Taping	2000
B	Packing in Bulk	500

Continued on the following page. ↗

Continued from the preceding page. ↘

Part Number (□: packaging code)	Inductance	Inductance Test Frequency	Q (min.)	Q Test Frequency	Rated Current	Max. of DC Resistance	S.R.F.* (min.)
LQW2BAN3N2J00□	3.2nH ±5%	250MHz	95	1500MHz	3800mA	0.02Ω	13800MHz
LQW2BAN3N6J00□	3.6nH ±5%	250MHz	75	1500MHz	2000mA	0.05Ω	11800MHz
LQW2BAN6N8J00□	6.8nH ±5%	250MHz	90	1000MHz	3000mA	0.03Ω	6200MHz
LQW2BAN7N5J00□	7.5nH ±5%	250MHz	85	1000MHz	2400mA	0.04Ω	3900MHz
LQW2BAN8N2G00□	8.2nH ±2%	250MHz	80	1000MHz	1500mA	0.09Ω	3200MHz
LQW2BAN8N2J00□	8.2nH ±5%	250MHz	80	1000MHz	1500mA	0.09Ω	3200MHz
LQW2BAN11NG00□	11nH ±2%	250MHz	80	500MHz	2400mA	0.04Ω	4700MHz
LQW2BAN11NJ00□	11nH ±5%	250MHz	80	500MHz	2400mA	0.04Ω	4700MHz
LQW2BAN12NG00□	12nH ±2%	250MHz	80	500MHz	2400mA	0.04Ω	4300MHz
LQW2BAN12NJ00□	12nH ±5%	250MHz	80	500MHz	2400mA	0.04Ω	4300MHz
LQW2BAN13NG00□	13nH ±2%	250MHz	80	500MHz	2400mA	0.04Ω	3500MHz
LQW2BAN13NJ00□	13nH ±5%	250MHz	80	500MHz	2400mA	0.04Ω	3500MHz
LQW2BAN15NG00□	15nH ±2%	250MHz	70	500MHz	1500mA	0.12Ω	1940MHz
LQW2BAN15NJ00□	15nH ±5%	250MHz	70	500MHz	1500mA	0.12Ω	1940MHz
LQW2BAN18NG00□	18nH ±2%	250MHz	85	500MHz	2200mA	0.05Ω	3620MHz
LQW2BAN18NJ00□	18nH ±5%	250MHz	85	500MHz	2200mA	0.05Ω	3620MHz
LQW2BAN20NG00□	20nH ±2%	250MHz	85	500MHz	2200mA	0.05Ω	2960MHz
LQW2BAN20NJ00□	20nH ±5%	250MHz	85	500MHz	2200mA	0.05Ω	2960MHz
LQW2BAN22NG00□	22nH ±2%	250MHz	85	500MHz	1900mA	0.07Ω	1850MHz
LQW2BAN22NJ00□	22nH ±5%	250MHz	85	500MHz	1900mA	0.07Ω	1850MHz
LQW2BAN24NG00□	24nH ±2%	250MHz	75	500MHz	1400mA	0.15Ω	1970MHz
LQW2BAN24NJ00□	24nH ±5%	250MHz	75	500MHz	1400mA	0.15Ω	1970MHz
LQW2BAN27NG00□	27nH ±2%	250MHz	85	500MHz	2000mA	0.07Ω	2750MHz
LQW2BAN27NJ00□	27nH ±5%	250MHz	85	500MHz	2000mA	0.07Ω	2750MHz
LQW2BAN30NG00□	30nH ±2%	250MHz	80	500MHz	2000mA	0.08Ω	2000MHz
LQW2BAN30NJ00□	30nH ±5%	250MHz	80	500MHz	2000mA	0.08Ω	2000MHz
LQW2BAN33NG00□	33nH ±2%	250MHz	75	500MHz	1500mA	0.12Ω	1900MHz
LQW2BAN33NJ00□	33nH ±5%	250MHz	75	500MHz	1500mA	0.12Ω	1900MHz
LQW2BAN36NG00□	36nH ±2%	250MHz	75	500MHz	1900mA	0.08Ω	1900MHz
LQW2BAN36NJ00□	36nH ±5%	250MHz	75	500MHz	1900mA	0.08Ω	1900MHz
LQW2BAN39NG00□	39nH ±2%	250MHz	75	500MHz	1900mA	0.08Ω	1900MHz
LQW2BAN39NJ00□	39nH ±5%	250MHz	75	500MHz	1900mA	0.08Ω	1900MHz
LQW2BAN43NG00□	43nH ±2%	200MHz	75	500MHz	1550mA	0.12Ω	1720MHz
LQW2BAN43NJ00□	43nH ±5%	200MHz	75	500MHz	1550mA	0.12Ω	1720MHz
LQW2BAN47NG00□	47nH ±2%	200MHz	70	500MHz	1250mA	0.20Ω	1500MHz
LQW2BAN47NJ00□	47nH ±5%	200MHz	70	500MHz	1250mA	0.20Ω	1500MHz
LQW2BAN51NG00□	51nH ±2%	200MHz	75	500MHz	1800mA	0.11Ω	1100MHz
LQW2BAN51NJ00□	51nH ±5%	200MHz	75	500MHz	1800mA	0.11Ω	1100MHz
LQW2BAN56NG00□	56nH ±2%	200MHz	70	500MHz	1250mA	0.18Ω	1600MHz
LQW2BAN56NJ00□	56nH ±5%	200MHz	70	500MHz	1250mA	0.18Ω	1600MHz
LQW2BAN62NG00□	62nH ±2%	200MHz	70	500MHz	1650mA	0.12Ω	1470MHz
LQW2BAN62NJ00□	62nH ±5%	200MHz	70	500MHz	1650mA	0.12Ω	1470MHz
LQW2BAN68NG00□	68nH ±2%	200MHz	70	500MHz	1250mA	0.2Ω	1470MHz
LQW2BAN68NJ00□	68nH ±5%	200MHz	70	500MHz	1250mA	0.2Ω	1470MHz
LQW2BAN75NG00□	75nH ±2%	200MHz	68	500MHz	1100mA	0.28Ω	1450MHz
LQW2BAN75NJ00□	75nH ±5%	200MHz	68	500MHz	1100mA	0.28Ω	1450MHz
LQW2BAN82NG00□	82nH ±2%	150MHz	70	500MHz	1200mA	0.24Ω	1330MHz
LQW2BAN82NJ00□	82nH ±5%	150MHz	70	500MHz	1200mA	0.24Ω	1330MHz
LQW2BAN91NG00□	91nH ±2%	150MHz	70	500MHz	1300mA	0.21Ω	1140MHz
LQW2BAN91NJ00□	91nH ±5%	150MHz	70	500MHz	1300mA	0.21Ω	1140MHz
LQW2BANR10G00□	100nH ±2%	150MHz	66	500MHz	1050mA	0.35Ω	1200MHz

Operating temp. range (Self-temp. rise included): -55 to 125°C

Only for reflow soldering

*S.R.F.: Self Resonant Frequency

In operating temperatures exceeding +85°C, derating of current is necessary for the LQW2BAN_00 series. Please apply the derating curve shown in the chart according to the operating temperature. When rated current is applied to the products, self-temperature rise shall be limited to 40°C max. Please consider "Notice (Rating)."

Continued on the following page. ↗

Continued from the preceding page. ↘

Part Number (□: packaging code)	Inductance	Inductance Test Frequency	Q (min.)	Q Test Frequency	Rated Current	Max. of DC Resistance	S.R.F.* (min.)
LQW2BANR10J00□	100nH ±5%	150MHz	66	500MHz	1050mA	0.35Ω	1200MHz
LQW2BANR11G00□	110nH ±2%	150MHz	57	250MHz	970mA	0.38Ω	1200MHz
LQW2BANR11J00□	110nH ±5%	150MHz	57	250MHz	970mA	0.38Ω	1200MHz
LQW2BANR12G00□	120nH ±2%	150MHz	57	250MHz	970mA	0.38Ω	1200MHz
LQW2BANR12J00□	120nH ±5%	150MHz	57	250MHz	970mA	0.38Ω	1200MHz
LQW2BANR13G00□	130nH ±2%	150MHz	56	250MHz	950mA	0.42Ω	1000MHz
LQW2BANR13J00□	130nH ±5%	150MHz	56	250MHz	950mA	0.42Ω	1000MHz
LQW2BANR15G00□	150nH ±2%	100MHz	58	250MHz	930mA	0.46Ω	920MHz
LQW2BANR15J00□	150nH ±5%	100MHz	58	250MHz	930mA	0.46Ω	920MHz
LQW2BANR16G00□	160nH ±2%	100MHz	53	250MHz	930mA	0.46Ω	920MHz
LQW2BANR16J00□	160nH ±5%	100MHz	53	250MHz	930mA	0.46Ω	920MHz
LQW2BANR18G00□	180nH ±2%	100MHz	53	250MHz	800mA	0.58Ω	920MHz
LQW2BANR18J00□	180nH ±5%	100MHz	53	250MHz	800mA	0.58Ω	920MHz
LQW2BANR20G00□	200nH ±2%	100MHz	53	250MHz	750mA	0.63Ω	920MHz
LQW2BANR20J00□	200nH ±5%	100MHz	53	250MHz	750mA	0.63Ω	920MHz

Operating temp. range (Self-temp. rise included): -55 to 125°C

Only for reflow soldering

*S.R.F.: Self Resonant Frequency

In operating temperatures exceeding +85°C, derating of current is necessary for the LQW2BAN_00 series. Please apply the derating curve shown in the chart according to the operating temperature. When rated current is applied to the products, self-temperature rise shall be limited to 40°C max. Please consider "Notice (Rating)."

Inductance-Frequency Characteristics (Typ.)



Q-Frequency Characteristics (Typ.)



Notice (Rating)

In operating temperatures exceeding +85°C, derating of current is necessary for this series. Please apply the derating curve shown in the chart according to the operating temperature.

Derating of Rated Current



LQW2BAS_00 Series 0805 (2015) inch (mm)



Packaging Code	Packaging	Minimum Quantity
K	ø330mm Embossed Taping	8000
L	ø180mm Embossed Taping	2000
B	Packing in Bulk	500

Continued on the following page. ↗

Continued from the preceding page. ↘

Part Number (□: packaging code)	Inductance	Inductance Test Frequency	Q (min.)	Q Test Frequency	Rated Current	Max. of DC Resistance	S.R.F.* (min.)
LQW2BAS2N7J00□	2.7nH ±5%	250MHz	80	1500MHz	910mA	0.03Ω	15000MHz
LQW2BAS2N8J00□	2.8nH ±5%	250MHz	80	1500MHz	800mA	0.06Ω	12200MHz
LQW2BAS3N0J00□	3.0nH ±5%	250MHz	65	1500MHz	800mA	0.06Ω	12200MHz
LQW2BAS5N6J00□	5.6nH ±5%	250MHz	65	1000MHz	600mA	0.08Ω	5900MHz
LQW2BAS6N0J00□	6.0nH ±5%	250MHz	70	1000MHz	600mA	0.03Ω	4500MHz
LQW2BAS6N8J00□	6.8nH ±5%	250MHz	50	1000MHz	600mA	0.11Ω	5600MHz
LQW2BAS7N5J00□	7.5nH ±5%	250MHz	50	1000MHz	600mA	0.14Ω	4800MHz
LQW2BAS8N2G00□	8.2nH ±2%	250MHz	50	1000MHz	600mA	0.12Ω	4400MHz
LQW2BAS8N2J00□	8.2nH ±5%	250MHz	50	1000MHz	600mA	0.12Ω	4400MHz
LQW2BAS10NG00□	10nH ±2%	250MHz	60	500MHz	600mA	0.10Ω	4300MHz
LQW2BAS10NJ00□	10nH ±5%	250MHz	60	500MHz	600mA	0.10Ω	4300MHz
LQW2BAS12NG00□	12nH ±2%	250MHz	50	500MHz	600mA	0.15Ω	4000MHz
LQW2BAS12NJ00□	12nH ±5%	250MHz	50	500MHz	600mA	0.15Ω	4000MHz
LQW2BAS15NG00□	15nH ±2%	250MHz	50	500MHz	600mA	0.17Ω	3200MHz
LQW2BAS15NJ00□	15nH ±5%	250MHz	50	500MHz	600mA	0.17Ω	3200MHz
LQW2BAS18NG00□	18nH ±2%	250MHz	50	500MHz	600mA	0.20Ω	3100MHz
LQW2BAS18NJ00□	18nH ±5%	250MHz	50	500MHz	600mA	0.20Ω	3100MHz
LQW2BAS22NG00□	22nH ±2%	250MHz	55	500MHz	500mA	0.22Ω	2600MHz
LQW2BAS22NJ00□	22nH ±5%	250MHz	55	500MHz	500mA	0.22Ω	2600MHz
LQW2BAS24NG00□	24nH ±2%	250MHz	50	500MHz	500mA	0.22Ω	2400MHz
LQW2BAS24NJ00□	24nH ±5%	250MHz	50	500MHz	500mA	0.22Ω	2400MHz
LQW2BAS27NG00□	27nH ±2%	250MHz	55	500MHz	500mA	0.25Ω	2580MHz
LQW2BAS27NJ00□	27nH ±5%	250MHz	55	500MHz	500mA	0.25Ω	2580MHz
LQW2BAS33NG00□	33nH ±2%	250MHz	60	500MHz	500mA	0.27Ω	2150MHz
LQW2BAS33NJ00□	33nH ±5%	250MHz	60	500MHz	500mA	0.27Ω	2150MHz
LQW2BAS36NG00□	36nH ±2%	250MHz	55	500MHz	500mA	0.27Ω	1900MHz
LQW2BAS36NJ00□	36nH ±5%	250MHz	55	500MHz	500mA	0.27Ω	1900MHz
LQW2BAS39NG00□	39nH ±2%	250MHz	60	500MHz	500mA	0.29Ω	2000MHz
LQW2BAS39NJ00□	39nH ±5%	250MHz	60	500MHz	500mA	0.29Ω	2000MHz
LQW2BAS43NG00□	43nH ±2%	200MHz	60	500MHz	500mA	0.34Ω	1800MHz
LQW2BAS43NJ00□	43nH ±5%	200MHz	60	500MHz	500mA	0.34Ω	1800MHz
LQW2BAS47NG00□	47nH ±2%	200MHz	60	500MHz	500mA	0.31Ω	1700MHz
LQW2BAS47NJ00□	47nH ±5%	200MHz	60	500MHz	500mA	0.31Ω	1700MHz
LQW2BAS56NG00□	56nH ±2%	200MHz	60	500MHz	500mA	0.34Ω	1600MHz
LQW2BAS56NJ00□	56nH ±5%	200MHz	60	500MHz	500mA	0.34Ω	1600MHz
LQW2BAS68NG00□	68nH ±2%	200MHz	60	500MHz	500mA	0.38Ω	1500MHz
LQW2BAS68NJ00□	68nH ±5%	200MHz	60	500MHz	500mA	0.38Ω	1500MHz
LQW2BAS82NG00□	82nH ±2%	150MHz	65	500MHz	400mA	0.42Ω	1330MHz
LQW2BAS82NJ00□	82nH ±5%	150MHz	65	500MHz	400mA	0.42Ω	1330MHz
LQW2BAS91NG00□	91nH ±2%	150MHz	65	500MHz	400mA	0.48Ω	1330MHz
LQW2BAS91NJ00□	91nH ±5%	150MHz	65	500MHz	400mA	0.48Ω	1330MHz
LQW2BASR10G00□	100nH ±2%	150MHz	65	500MHz	400mA	0.46Ω	1250MHz
LQW2BASR10J00□	100nH ±5%	150MHz	65	500MHz	400mA	0.46Ω	1250MHz
LQW2BASR11G00□	110nH ±2%	150MHz	50	250MHz	400mA	0.48Ω	1100MHz
LQW2BASR11J00□	110nH ±5%	150MHz	50	250MHz	400mA	0.48Ω	1100MHz
LQW2BASR12G00□	120nH ±2%	150MHz	50	250MHz	400mA	0.51Ω	1100MHz
LQW2BASR12J00□	120nH ±5%	150MHz	50	250MHz	400mA	0.51Ω	1100MHz
LQW2BASR15G00□	150nH ±2%	100MHz	50	250MHz	400mA	0.56Ω	920MHz
LQW2BASR15J00□	150nH ±5%	100MHz	50	250MHz	400mA	0.56Ω	920MHz
LQW2BASR18G00□	180nH ±2%	100MHz	50	250MHz	400mA	0.64Ω	920MHz
LQW2BASR18J00□	180nH ±5%	100MHz	50	250MHz	400mA	0.64Ω	920MHz
LQW2BASR22G00□	220nH ±2%	100MHz	50	250MHz	400mA	0.70Ω	820MHz
LQW2BASR22J00□	220nH ±5%	100MHz	50	250MHz	400mA	0.70Ω	820MHz

Operating temp. range: -55 to 125°C
 Only for reflow soldering
 *S.R.F.: Self Resonant Frequency

Continued on the following page. ↗

Continued from the preceding page. ↘

Part Number (□: packaging code)	Inductance	Inductance Test Frequency	Q (min.)	Q Test Frequency	Rated Current	Max. of DC Resistance	S.R.F.* (min.)
LQW2BASR24G00□	240nH ±2%	100MHz	44	250MHz	350mA	1.00Ω	770MHz
LQW2BASR24J00□	240nH ±5%	100MHz	44	250MHz	350mA	1.00Ω	770MHz
LQW2BASR27G00□	270nH ±2%	100MHz	48	250MHz	350mA	1.00Ω	730MHz
LQW2BASR27J00□	270nH ±5%	100MHz	48	250MHz	350mA	1.00Ω	730MHz
LQW2BASR33G00□	330nH ±2%	100MHz	48	250MHz	310mA	1.40Ω	650MHz
LQW2BASR33J00□	330nH ±5%	100MHz	48	250MHz	310mA	1.40Ω	650MHz
LQW2BASR39J00□	390nH ±5%	100MHz	48	250MHz	290mA	1.50Ω	600MHz
LQW2BASR47J00□	470nH ±5%	50MHz	33	100MHz	250mA	1.76Ω	300MHz
LQW2BASR56J00□	560nH ±5%	25MHz	23	50MHz	230mA	1.90Ω	270MHz
LQW2BASR68J00□	680nH ±5%	25MHz	23	50MHz	190mA	2.20Ω	250MHz
LQW2BASR82J00□	820nH ±5%	25MHz	23	50MHz	180mA	2.35Ω	230MHz
LQW2BAS1R0J00□	1000nH ±5%	25MHz	23	50MHz	170mA	2.4Ω	200MHz

Operating temp. range: -55 to 125°C

Only for reflow soldering

*S.R.F.: Self Resonant Frequency

Inductance-Frequency Characteristics (Typ.)



Q-Frequency Characteristics (Typ.)



LQW2BHN_03 Series 0805 (2015) inch (mm)



Packaging Code	Packaging	Minimum Quantity
K	ø330mm Embossed Taping	7500
L	ø180mm Embossed Taping	2000

Part Number (□: packaging code)	Inductance	Inductance Test Frequency	Q (min.)	Q Test Frequency	Rated Current	Max. of DC Resistance	S.R.F.* (min.)
LQW2BHN3N3D03□	3.3nH ±0.5nH	100MHz	10	250MHz	910mA	0.05Ω	6000MHz
LQW2BHN6N8D03□	6.8nH ±0.5nH	100MHz	20	250MHz	680mA	0.11Ω	5400MHz
LQW2BHN8N2D03□	8.2nH ±0.5nH	100MHz	20	250MHz	630mA	0.12Ω	3900MHz
LQW2BHN10NJ03□	10nH ±5%	100MHz	30	250MHz	1320mA	0.03Ω	3300MHz
LQW2BHN12NJ03□	12nH ±5%	100MHz	30	250MHz	680mA	0.11Ω	3200MHz
LQW2BHN15NJ03□	15nH ±5%	100MHz	30	250MHz	630mA	0.12Ω	2700MHz
LQW2BHN18NJ03□	18nH ±5%	100MHz	30	250MHz	690mA	0.10Ω	2600MHz
LQW2BHN22NJ03□	22nH ±5%	100MHz	30	250MHz	720mA	0.09Ω	2100MHz
LQW2BHN27NJ03□	27nH ±5%	100MHz	40	250MHz	540mA	0.17Ω	2300MHz

Operating temp. range: -40 to 85°C

*S.R.F.: Self Resonant Frequency

Continued on the following page. ↗

Continued from the preceding page. ↘

Part Number (□: packaging code)	Inductance	Inductance Test Frequency	Q (min.)	Q Test Frequency	Rated Current	Max. of DC Resistance	S.R.F.* (min.)
LQW2BHN33NG03□	33nH ±2%	100MHz	40	250MHz	570mA	0.15Ω	1900MHz
LQW2BHN33NJ03□	33nH ±5%	100MHz	40	250MHz	570mA	0.15Ω	1900MHz
LQW2BHN39NG03□	39nH ±2%	100MHz	40	250MHz	730mA	0.09Ω	1700MHz
LQW2BHN39NJ03□	39nH ±5%	100MHz	40	250MHz	730mA	0.09Ω	1700MHz
LQW2BHN47NG03□	47nH ±2%	100MHz	40	200MHz	450mA	0.23Ω	1600MHz
LQW2BHN47NJ03□	47nH ±5%	100MHz	40	200MHz	450mA	0.23Ω	1600MHz
LQW2BHN56NG03□	56nH ±2%	100MHz	40	200MHz	430mA	0.26Ω	1500MHz
LQW2BHN56NJ03□	56nH ±5%	100MHz	40	200MHz	430mA	0.26Ω	1500MHz
LQW2BHN68NG03□	68nH ±2%	100MHz	40	200MHz	460mA	0.23Ω	1200MHz
LQW2BHN68NJ03□	68nH ±5%	100MHz	40	200MHz	460mA	0.23Ω	1200MHz
LQW2BHN82NG03□	82nH ±2%	100MHz	40	150MHz	320mA	0.42Ω	1100MHz
LQW2BHN82NJ03□	82nH ±5%	100MHz	40	150MHz	320mA	0.42Ω	1100MHz
LQW2BHNR10G03□	100nH ±2%	100MHz	35	150MHz	270mA	0.55Ω	900MHz
LQW2BHNR10J03□	100nH ±5%	100MHz	40	150MHz	350mA	0.38Ω	900MHz
LQW2BHNR12G03□	120nH ±2%	100MHz	40	150MHz	320mA	0.40Ω	750MHz
LQW2BHNR12J03□	120nH ±5%	100MHz	40	150MHz	320mA	0.40Ω	750MHz
LQW2BHNR15G03□	150nH ±2%	100MHz	30	150MHz	260mA	0.68Ω	350MHz
LQW2BHNR15J03□	150nH ±5%	100MHz	30	150MHz	390mA	0.47Ω	350MHz
LQW2BHNR18G03□	180nH ±2%	100MHz	35	100MHz	250mA	0.71Ω	700MHz
LQW2BHNR18J03□	180nH ±5%	100MHz	35	100MHz	250mA	0.71Ω	700MHz
LQW2BHNR22G03□	220nH ±2%	100MHz	35	100MHz	240mA	0.70Ω	500MHz
LQW2BHNR22J03□	220nH ±5%	100MHz	35	100MHz	240mA	0.70Ω	500MHz
LQW2BHNR27J03□	270nH ±5%	10MHz	15	25.2MHz	190mA	2.00Ω	550MHz
LQW2BHNR27K03□	270nH ±10%	10MHz	15	25.2MHz	190mA	2.00Ω	550MHz
LQW2BHNR33J03□	330nH ±5%	10MHz	15	25.2MHz	180mA	2.20Ω	500MHz
LQW2BHNR33K03□	330nH ±10%	10MHz	15	25.2MHz	180mA	2.20Ω	500MHz
LQW2BHNR39J03□	390nH ±5%	10MHz	15	25.2MHz	170mA	2.50Ω	400MHz
LQW2BHNR39K03□	390nH ±10%	10MHz	15	25.2MHz	170mA	2.50Ω	400MHz
LQW2BHNR47J03□	470nH ±5%	10MHz	15	25.2MHz	160mA	2.80Ω	350MHz
LQW2BHNR47K03□	470nH ±10%	10MHz	15	25.2MHz	160mA	2.80Ω	350MHz

Operating temp. range: -40 to 85°C

*S.R.F.: Self Resonant Frequency

Inductance-Frequency Characteristics (Typ.)



Q-Frequency Characteristics (Typ.)



LQW2BHN_13 Series 0805 (2015) inch (mm)



Packaging Code	Packaging	Minimum Quantity
K	ø330mm Embossed Taping	7500
L	ø180mm Embossed Taping	2000

Part Number (□: packaging code)	Inductance	Inductance Test Frequency	Q (min.)	Q Test Frequency	Rated Current	Max. of DC Resistance	S.R.F.* (min.)
LQW2BHN2N7D13□	2.7nH ±0.5nH	100MHz	20	250MHz	1900mA	0.02Ω	6000MHz
LQW2BHN3N1D13□	3.1nH ±0.5nH	100MHz	20	250MHz	1800mA	0.02Ω	6000MHz
LQW2BHN3N3D13□	3.3nH ±0.5nH	100MHz	20	250MHz	1700mA	0.02Ω	6000MHz
LQW2BHN5N6D13□	5.6nH ±0.5nH	100MHz	35	250MHz	1500mA	0.02Ω	6000MHz
LQW2BHN6N8D13□	6.8nH ±0.5nH	100MHz	35	250MHz	1400mA	0.02Ω	5400MHz
LQW2BHN8N6D13□	8.6nH ±0.5nH	100MHz	35	250MHz	1300mA	0.03Ω	3900MHz
LQW2BHN10NJ13□	10nH ±5%	100MHz	35	250MHz	1320mA	0.03Ω	3300MHz
LQW2BHN12NK13□	12nH ±10%	100MHz	40	250MHz	1100mA	0.04Ω	3200MHz
LQW2BHN15NK13□	15nH ±10%	100MHz	40	250MHz	1000mA	0.04Ω	3100MHz
LQW2BHN18NK13□	18.8nH ±10%	100MHz	40	250MHz	1000mA	0.05Ω	2600MHz
LQW2BHN21NK13□	21nH ±10%	100MHz	40	250MHz	950mA	0.05Ω	2200MHz
LQW2BHN27NK13□	27nH ±10%	100MHz	40	250MHz	900mA	0.06Ω	1800MHz

Operating temp. range: -40 to 85°C

*S.R.F.: Self Resonant Frequency

Inductance-Frequency Characteristics (Typ.)



Q-Frequency Characteristics (Typ.)



LQW2UAS_00 Series 1008 (2520) inch (mm)



Packaging Code	Packaging	Minimum Quantity
L	ø180mm Embossed Taping	2000
B	Packing in Bulk	500

Continued on the following page. ↗

Continued from the preceding page. ↘

Part Number (□: packaging code)	Inductance	Inductance Test Frequency	Q (min.)	Q Test Frequency	Rated Current	Max. of DC Resistance	S.R.F.* (min.)
LQW2UAS12NG00□	12nH ±2%	50MHz	50	500MHz	1000mA	0.09Ω	3300MHz
LQW2UAS12NJ00□	12nH ±5%	50MHz	50	500MHz	1000mA	0.09Ω	3300MHz
LQW2UAS18NG00□	18nH ±2%	50MHz	50	350MHz	1000mA	0.11Ω	2500MHz
LQW2UAS18NJ00□	18nH ±5%	50MHz	50	350MHz	1000mA	0.11Ω	2500MHz
LQW2UAS22NF00□	22nH ±1%	50MHz	55	350MHz	1000mA	0.12Ω	2400MHz
LQW2UAS22NG00□	22nH ±2%	50MHz	55	350MHz	1000mA	0.12Ω	2400MHz
LQW2UAS22NJ00□	22nH ±5%	50MHz	55	350MHz	1000mA	0.12Ω	2400MHz
LQW2UAS27NG00□	27nH ±2%	50MHz	55	350MHz	1000mA	0.13Ω	1600MHz
LQW2UAS27NJ00□	27nH ±5%	50MHz	55	350MHz	1000mA	0.13Ω	1600MHz
LQW2UAS33NF00□	33nH ±1%	50MHz	60	350MHz	1000mA	0.14Ω	1600MHz
LQW2UAS33NG00□	33nH ±2%	50MHz	60	350MHz	1000mA	0.14Ω	1600MHz
LQW2UAS33NJ00□	33nH ±5%	50MHz	60	350MHz	1000mA	0.14Ω	1600MHz
LQW2UAS39NF00□	39nH ±1%	50MHz	60	350MHz	1000mA	0.15Ω	1500MHz
LQW2UAS39NG00□	39nH ±2%	50MHz	60	350MHz	1000mA	0.15Ω	1500MHz
LQW2UAS39NJ00□	39nH ±5%	50MHz	60	350MHz	1000mA	0.15Ω	1500MHz
LQW2UAS47NF00□	47nH ±1%	50MHz	65	350MHz	1000mA	0.16Ω	1500MHz
LQW2UAS47NG00□	47nH ±2%	50MHz	65	350MHz	1000mA	0.16Ω	1500MHz
LQW2UAS47NJ00□	47nH ±5%	50MHz	65	350MHz	1000mA	0.16Ω	1500MHz
LQW2UAS56NF00□	56nH ±1%	50MHz	65	350MHz	1000mA	0.18Ω	1300MHz
LQW2UAS56NG00□	56nH ±2%	50MHz	65	350MHz	1000mA	0.18Ω	1300MHz
LQW2UAS56NJ00□	56nH ±5%	50MHz	65	350MHz	1000mA	0.18Ω	1300MHz
LQW2UAS68NF00□	68nH ±1%	50MHz	65	350MHz	1000mA	0.2Ω	1300MHz
LQW2UAS68NG00□	68nH ±2%	50MHz	65	350MHz	1000mA	0.2Ω	1300MHz
LQW2UAS68NJ00□	68nH ±5%	50MHz	65	350MHz	1000mA	0.2Ω	1300MHz
LQW2UAS82NF00□	82nH ±1%	50MHz	60	350MHz	1000mA	0.22Ω	1000MHz
LQW2UAS82NG00□	82nH ±2%	50MHz	60	350MHz	1000mA	0.22Ω	1000MHz
LQW2UAS82NJ00□	82nH ±5%	50MHz	60	350MHz	1000mA	0.22Ω	1000MHz
LQW2UASR10F00□	100nH ±1%	25MHz	60	350MHz	650mA	0.56Ω	1000MHz
LQW2UASR10G00□	100nH ±2%	25MHz	60	350MHz	650mA	0.56Ω	1000MHz
LQW2UASR10J00□	100nH ±5%	25MHz	60	350MHz	650mA	0.56Ω	1000MHz
LQW2UASR12F00□	120nH ±1%	25MHz	60	350MHz	650mA	0.63Ω	950MHz
LQW2UASR12G00□	120nH ±2%	25MHz	60	350MHz	650mA	0.63Ω	950MHz
LQW2UASR12J00□	120nH ±5%	25MHz	60	350MHz	650mA	0.63Ω	950MHz
LQW2UASR15F00□	150nH ±1%	25MHz	45	100MHz	580mA	0.7Ω	850MHz
LQW2UASR15G00□	150nH ±2%	25MHz	45	100MHz	580mA	0.7Ω	850MHz
LQW2UASR15J00□	150nH ±5%	25MHz	45	100MHz	580mA	0.7Ω	850MHz
LQW2UASR18F00□	180nH ±1%	25MHz	45	100MHz	620mA	0.77Ω	750MHz
LQW2UASR18G00□	180nH ±2%	25MHz	45	100MHz	620mA	0.77Ω	750MHz
LQW2UASR18J00□	180nH ±5%	25MHz	45	100MHz	620mA	0.77Ω	750MHz
LQW2UASR22F00□	220nH ±1%	25MHz	45	100MHz	500mA	0.84Ω	700MHz
LQW2UASR22G00□	220nH ±2%	25MHz	45	100MHz	500mA	0.84Ω	700MHz
LQW2UASR22J00□	220nH ±5%	25MHz	45	100MHz	500mA	0.84Ω	700MHz
LQW2UASR27F00□	270nH ±1%	25MHz	45	100MHz	500mA	0.91Ω	600MHz
LQW2UASR27G00□	270nH ±2%	25MHz	45	100MHz	500mA	0.91Ω	600MHz
LQW2UASR27J00□	270nH ±5%	25MHz	45	100MHz	500mA	0.91Ω	600MHz
LQW2UASR33F00□	330nH ±1%	25MHz	45	100MHz	450mA	1.05Ω	570MHz
LQW2UASR33G00□	330nH ±2%	25MHz	45	100MHz	450mA	1.05Ω	570MHz
LQW2UASR33J00□	330nH ±5%	25MHz	45	100MHz	450mA	1.05Ω	570MHz
LQW2UASR39F00□	390nH ±1%	25MHz	45	100MHz	470mA	1.12Ω	500MHz
LQW2UASR39G00□	390nH ±2%	25MHz	45	100MHz	470mA	1.12Ω	500MHz
LQW2UASR39J00□	390nH ±5%	25MHz	45	100MHz	470mA	1.12Ω	500MHz
LQW2UASR47F00□	470nH ±1%	25MHz	45	100MHz	470mA	1.19Ω	450MHz
LQW2UASR47G00□	470nH ±2%	25MHz	45	100MHz	470mA	1.19Ω	450MHz

Operating temp. range: -55 to 125°C
 Only for reflow soldering
 *S.R.F.: Self Resonant Frequency

Continued on the following page. ↗

Continued from the preceding page. ↘

Part Number (□: packaging code)	Inductance	Inductance Test Frequency	Q (min.)	Q Test Frequency	Rated Current	Max. of DC Resistance	S.R.F.* (min.)
LQW2UASR47J00□	470nH ±5%	25MHz	45	100MHz	470mA	1.19Ω	450MHz
LQW2UASR56F00□	560nH ±1%	25MHz	45	100MHz	400mA	1.33Ω	415MHz
LQW2UASR56G00□	560nH ±2%	25MHz	45	100MHz	400mA	1.33Ω	415MHz
LQW2UASR56J00□	560nH ±5%	25MHz	45	100MHz	400mA	1.33Ω	415MHz
LQW2UASR62F00□	620nH ±1%	25MHz	45	100MHz	300mA	1.4Ω	375MHz
LQW2UASR62G00□	620nH ±2%	25MHz	45	100MHz	300mA	1.4Ω	375MHz
LQW2UASR62J00□	620nH ±5%	25MHz	45	100MHz	300mA	1.4Ω	375MHz
LQW2UASR68F00□	680nH ±1%	25MHz	45	100MHz	400mA	1.47Ω	375MHz
LQW2UASR68G00□	680nH ±2%	25MHz	45	100MHz	400mA	1.47Ω	375MHz
LQW2UASR68J00□	680nH ±5%	25MHz	45	100MHz	400mA	1.47Ω	375MHz
LQW2UASR75F00□	750nH ±1%	25MHz	45	100MHz	360mA	1.54Ω	360MHz
LQW2UASR75G00□	750nH ±2%	25MHz	45	100MHz	360mA	1.54Ω	360MHz
LQW2UASR75J00□	750nH ±5%	25MHz	45	100MHz	360mA	1.54Ω	360MHz
LQW2UASR82F00□	820nH ±1%	25MHz	45	100MHz	400mA	1.61Ω	350MHz
LQW2UASR82G00□	820nH ±2%	25MHz	45	100MHz	400mA	1.61Ω	350MHz
LQW2UASR82J00□	820nH ±5%	25MHz	45	100MHz	400mA	1.61Ω	350MHz
LQW2UASR91F00□	910nH ±1%	25MHz	35	50MHz	380mA	1.68Ω	320MHz
LQW2UASR91G00□	910nH ±2%	25MHz	35	50MHz	380mA	1.68Ω	320MHz
LQW2UASR91J00□	910nH ±5%	25MHz	35	50MHz	380mA	1.68Ω	320MHz
LQW2UAS1R0F00□	1000nH ±1%	25MHz	35	50MHz	370mA	1.75Ω	290MHz
LQW2UAS1R0G00□	1000nH ±2%	25MHz	35	50MHz	370mA	1.75Ω	290MHz
LQW2UAS1R0J00□	1000nH ±5%	25MHz	35	50MHz	370mA	1.75Ω	290MHz
LQW2UAS1R2J00□	1200nH ±5%	7.9MHz	35	50MHz	310mA	2.0Ω	210MHz
LQW2UAS1R5J00□	1500nH ±5%	7.9MHz	28	50MHz	330mA	2.3Ω	120MHz
LQW2UAS1R8J00□	1800nH ±5%	7.9MHz	28	50MHz	300mA	2.6Ω	140MHz
LQW2UAS2R2J00□	2200nH ±5%	7.9MHz	28	50MHz	280mA	2.8Ω	130MHz
LQW2UAS2R7J00□	2700nH ±5%	7.9MHz	22	25MHz	290mA	3.2Ω	110MHz
LQW2UAS3R3J00□	3300nH ±5%	7.9MHz	22	25MHz	290mA	3.4Ω	90MHz
LQW2UAS3R9J00□	3900nH ±5%	7.9MHz	20	25MHz	260mA	3.6Ω	70MHz
LQW2UAS4R7J00□	4700nH ±5%	7.9MHz	20	25MHz	260mA	4.0Ω	60MHz

Operating temp. range: -55 to 125°C

Only for reflow soldering

*S.R.F.: Self Resonant Frequency

Inductance-Frequency Characteristics (Typ.)



Q-Frequency Characteristics (Typ.)



LQW31HN_03 Series 1206 (3216) inch (mm)



Packaging Code	Packaging	Minimum Quantity
K	ø330mm Embossed Taping	7500
L	ø180mm Embossed Taping	2000

Part Number (□: packaging code)	Inductance	Inductance Test Frequency	Q (min.)	Q Test Frequency	Rated Current	DC Resistance	S.R.F.* (min.)
LQW31HN8N8J03□	8.8nH ±5%	100MHz	50	436MHz	750mA	0.029Ω±40%	1000MHz
LQW31HN8N8K03□	8.8nH ±10%	100MHz	50	436MHz	750mA	0.029Ω±40%	1000MHz
LQW31HN15NJ03□	14.7nH ±5%	100MHz	60	436MHz	680mA	0.035Ω±40%	1000MHz
LQW31HN15NK03□	14.7nH ±10%	100MHz	60	436MHz	680mA	0.035Ω±40%	1000MHz
LQW31HN17NJ03□	17nH ±5%	100MHz	60	436MHz	650mA	0.037Ω±40%	1000MHz
LQW31HN17NK03□	17nH ±10%	100MHz	60	436MHz	650mA	0.037Ω±40%	1000MHz
LQW31HN23NJ03□	23nH ±5%	100MHz	60	436MHz	590mA	0.046Ω±40%	1000MHz
LQW31HN23NK03□	23nH ±10%	100MHz	60	436MHz	590mA	0.046Ω±40%	1000MHz
LQW31HN27NJ03□	27nH ±5%	100MHz	60	436MHz	560mA	0.051Ω±40%	1000MHz
LQW31HN27NK03□	27nH ±10%	100MHz	60	436MHz	560mA	0.051Ω±40%	1000MHz
LQW31HN33NJ03□	33nH ±5%	100MHz	60	436MHz	530mA	0.057Ω±40%	1000MHz
LQW31HN33NK03□	33nH ±10%	100MHz	60	436MHz	530mA	0.057Ω±40%	1000MHz
LQW31HN39NJ03□	39nH ±5%	100MHz	60	436MHz	490mA	0.067Ω±40%	1000MHz
LQW31HN39NK03□	39nH ±10%	100MHz	60	436MHz	490mA	0.067Ω±40%	1000MHz
LQW31HN47NJ03□	47nH ±5%	100MHz	60	436MHz	380mA	0.11Ω±40%	1000MHz
LQW31HN47NK03□	47nH ±10%	100MHz	60	436MHz	380mA	0.11Ω±40%	1000MHz
LQW31HN56NJ03□	56nH ±5%	100MHz	60	436MHz	330mA	0.14Ω±40%	1000MHz
LQW31HN56NK03□	56nH ±10%	100MHz	60	436MHz	330mA	0.14Ω±40%	1000MHz
LQW31HN64NJ03□	64nH ±5%	100MHz	60	436MHz	290mA	0.18Ω±40%	1000MHz
LQW31HN64NK03□	64nH ±10%	100MHz	60	436MHz	290mA	0.18Ω±40%	1000MHz
LQW31HN84NJ03□	84nH ±5%	100MHz	60	436MHz	240mA	0.28Ω±40%	1000MHz
LQW31HN84NK03□	84nH ±10%	100MHz	60	436MHz	240mA	0.28Ω±40%	1000MHz
LQW31HNR10J03□	100nH ±5%	100MHz	60	436MHz	230mA	0.3Ω±40%	900MHz
LQW31HNR10K03□	100nH ±10%	100MHz	60	436MHz	230mA	0.3Ω±40%	900MHz

Operating temp. range (Self-temp. rise not included): -40 to 85°C

*S.R.F.: Self Resonant Frequency

Inductance-Frequency Characteristics (Typ.)



Q-Frequency Characteristics (Typ.)



Inductors for Power Lines

Inductors for General Circuits

LQW31HN_03
RF Inductors

LQW15CN_00 Series 0402 (1005) inch (mm)



(in mm)

Packaging Code	Packaging	Minimum Quantity
D	ø180mm Paper Taping	10000
B	Packing in Bulk	500

Part Number (□: packaging code)	Inductance	Inductance Test Frequency	Rated Current	Max. of DC Resistance	S.R.F.* (min.)
LQW15CN18NJ00□	18nH ±5%	100MHz	1400mA	0.046Ω	3000MHz
LQW15CN33NJ00□	33nH ±5%	100MHz	1300mA	0.065Ω	1800MHz
LQW15CN48NJ00□	48nH ±5%	100MHz	1100mA	0.078Ω	1400MHz
LQW15CN70NJ00□	70nH ±5%	100MHz	820mA	0.12Ω	1300MHz
LQW15CN96NJ00□	96nH ±5%	100MHz	730mA	0.16Ω	1100MHz
LQW15CNR13J00□	130nH ±5%	100MHz	640mA	0.23Ω	1000MHz
LQW15CNR16J00□	160nH ±5%	100MHz	480mA	0.33Ω	900MHz
LQW15CNR20J00□	200nH ±5%	100MHz	390mA	0.47Ω	800MHz

Operating temp. range (Self-temp. rise not included): -55 to 125°C

Class of Magnetic Shield: No Shield

Only for reflow soldering

*S.R.F.: Self Resonant Frequency

In operating temperatures exceeding +85°C, derating of current is necessary for the LQW15C series. Please apply the derating curve shown in the chart according to the operating temperature. Please consider "Notice (Rating)."

Inductance-Frequency Characteristics (Typ.)



— LQW15CN18NJ00 18nH - - - LQW15CN70NJ00 70nH
 — LQW15CNR13J00 130nH - - - LQW15CNR20J00 200nH

Impedance-Frequency Characteristics (Typ.)



— LQW15CN18NJ00 18nH - - - LQW15CN70NJ00 70nH
 — LQW15CNR13J00 130nH - - - LQW15CNR20J00 200nH

Notice (Rating)

In operating temperatures exceeding +85°C, derating of current is necessary for this series. Please apply the derating curve shown in the chart according to the operating temperature.

Derating of Rated Current



LQW15CN_10 Series 0402 (1005) inch (mm)



(in mm)

Packaging Code	Packaging	Minimum Quantity
D	ø180mm Paper Taping	10000
B	Packing in Bulk	500

Continued on the following page. ↗

Continued from the preceding page. ↘

Part Number (□: packaging code)	Inductance	Inductance Test Frequency	Rated Current	Max. of DC Resistance	S.R.F.* (min.)
LQW15CN20NJ10□	20nH ±5%	100MHz	2200mA	0.028Ω	3000MHz
LQW15CN20NK10□	20nH ±10%	100MHz	2200mA	0.028Ω	3000MHz
LQW15CN34NJ10□	34nH ±5%	100MHz	1800mA	0.036Ω	2500MHz
LQW15CN34NK10□	34nH ±10%	100MHz	1800mA	0.036Ω	2500MHz
LQW15CN53NJ10□	53nH ±5%	100MHz	1300mA	0.06Ω	2000MHz
LQW15CN53NK10□	53nH ±10%	100MHz	1300mA	0.06Ω	2000MHz
LQW15CN77NJ10□	77nH ±5%	100MHz	1100mA	0.09Ω	2000MHz
LQW15CN77NK10□	77nH ±10%	100MHz	1100mA	0.09Ω	2000MHz
LQW15CNR11J10□	106nH ±5%	100MHz	850mA	0.144Ω	1500MHz
LQW15CNR11K10□	106nH ±10%	100MHz	850mA	0.144Ω	1500MHz
LQW15CNR14J10□	140nH ±5%	100MHz	650mA	0.216Ω	1000MHz
LQW15CNR14K10□	140nH ±10%	100MHz	650mA	0.216Ω	1000MHz
LQW15CNR18J10□	180nH ±5%	100MHz	560mA	0.312Ω	1000MHz
LQW15CNR18K10□	180nH ±10%	100MHz	560mA	0.312Ω	1000MHz
LQW15CNR22J10□	220nH ±5%	100MHz	450mA	0.47Ω	1400MHz
LQW15CNR22K10□	220nH ±10%	100MHz	450mA	0.47Ω	1400MHz
LQW15CNR27J10□	270nH ±5%	100MHz	420mA	0.52Ω	830MHz
LQW15CNR27K10□	270nH ±10%	100MHz	420mA	0.52Ω	830MHz
LQW15CNR33J10□	330nH ±5%	100MHz	390mA	0.56Ω	520MHz
LQW15CNR33K10□	330nH ±10%	100MHz	390mA	0.56Ω	520MHz
LQW15CNR39J10□	390nH ±5%	100MHz	370mA	0.62Ω	450MHz
LQW15CNR39K10□	390nH ±10%	100MHz	370mA	0.62Ω	450MHz
LQW15CNR42J10□	420nH ±5%	10MHz	370mA	0.62Ω	400MHz
LQW15CNR42K10□	420nH ±10%	10MHz	370mA	0.62Ω	400MHz
LQW15CNR47J10□	470nH ±5%	10MHz	350mA	0.66Ω	380MHz
LQW15CNR47K10□	470nH ±10%	10MHz	350mA	0.66Ω	380MHz
LQW15CNR56J10□	560nH ±5%	10MHz	300mA	0.71Ω	300MHz
LQW15CNR56K10□	560nH ±10%	10MHz	300mA	0.71Ω	300MHz
LQW15CNR68M10□	680nH ±20%	1MHz	290mA	0.78Ω	290MHz
LQW15CNR82M10□	820nH ±20%	1MHz	275mA	0.84Ω	200MHz
LQW15CN1R0M10□	1000nH ±20%	1MHz	270mA	0.94Ω	120MHz
LQW15CN1R5M10□	1500nH ±20%	1MHz	190mA	1.50Ω	120MHz
LQW15CN2R2M10□	2200nH ±20%	1MHz	170mA	1.80Ω	100MHz
LQW15CN3R3M10□	3300nH ±20%	1MHz	130mA	3.65Ω	80MHz

Operating temp. range (Self-temp. rise not included): -55 to 125°C

Class of Magnetic Shield: No Shield

Only for reflow soldering

*S.R.F.: Self Resonant Frequency

In operating temperatures exceeding +85°C, derating of current is necessary for the LQW15C series. Please apply the derating curve shown in the chart according to the operating temperature. Please consider "Notice (Rating)."

Inductance-Frequency Characteristics (Typ.)



Impedance-Frequency Characteristics (Typ.)



Notice (Rating)

In operating temperatures exceeding +85°C, derating of current is necessary for this series.

Please apply the derating curve shown in the chart according to the operating temperature.

Derating of Rated Current



LQW18CN_00 Series 0603 (1608) inch (mm)



Packaging Code	Packaging	Minimum Quantity
D	ø180mm Paper Taping	4000
J	ø330mm Paper Taping	10000
B	Packing in Bulk	500

Part Number (□: packaging code)	Inductance	Inductance Test Frequency	Rated Current	Max. of DC Resistance	S.R.F.* (min.)
LQW18CN4N9D00□	4.9nH ±0.5nH	10MHz	2600mA	0.015Ω	2300MHz
LQW18CN15NJ00□	15nH ±5%	10MHz	2200mA	0.025Ω	2000MHz
LQW18CN33NJ00□	33nH ±5%	10MHz	1700mA	0.035Ω	1800MHz
LQW18CN55NJ00□	55nH ±5%	10MHz	1500mA	0.045Ω	1600MHz
LQW18CN85NJ00□	85nH ±5%	10MHz	1400mA	0.060Ω	1380MHz
LQW18CNR10K00□	100nH ±10%	10MHz	1000mA	0.10Ω	1260MHz
LQW18CNR12J00□	120nH ±5%	10MHz	1100mA	0.085Ω	1200MHz
LQW18CNR16J00□	160nH ±5%	10MHz	1000mA	0.10Ω	900MHz
LQW18CNR21J00□	210nH ±5%	10MHz	800mA	0.15Ω	720MHz
LQW18CNR27J00□	270nH ±5%	10MHz	750mA	0.16Ω	660MHz
LQW18CNR33J00□	330nH ±5%	10MHz	630mA	0.25Ω	600MHz
LQW18CNR39J00□	390nH ±5%	10MHz	620mA	0.28Ω	570MHz
LQW18CNR47J00□	470nH ±5%	10MHz	500mA	0.45Ω	555MHz
LQW18CNR56J00□	560nH ±5%	10MHz	450mA	0.48Ω	540MHz
LQW18CNR65J00□	650nH ±5%	10MHz	430mA	0.52Ω	510MHz

Operating temp. range: -40 to 85°C
 Class of Magnetic Shield: No Shield
 Only for reflow soldering
 *S.R.F.: Self Resonant Frequency

Inductance-Frequency Characteristics (Typ.)



Impedance-Frequency Characteristics (Typ.)



LQW21HN_00 Series 0805 (2012) inch (mm)



Packaging Code	Packaging	Minimum Quantity
L	ø180mm Embossed Taping	3000
B	Packing in Bulk	500

Part Number (□: packaging code)	Inductance	Inductance Test Frequency	Q (min.)	Q Test Frequency	Rated Current	Max. of DC Resistance	S.R.F.* (min.)
LQW21HNR47J00□	0.47μH ±5%	10MHz	35	100MHz	160mA	1.30Ω	620MHz
LQW21HNR56J00□	0.56μH ±5%	10MHz	35	100MHz	150mA	1.43Ω	580MHz
LQW21HNR68J00□	0.68μH ±5%	10MHz	35	100MHz	130mA	2.21Ω	520MHz
LQW21HNR82J00□	0.82μH ±5%	10MHz	35	100MHz	125mA	2.34Ω	480MHz
LQW21HN1R0J00□	1.0μH ±5%	10MHz	35	100MHz	115mA	2.86Ω	450MHz
LQW21HN1R2J00□	1.2μH ±5%	10MHz	35	100MHz	100mA	3.12Ω	400MHz
LQW21HN1R5J00□	1.5μH ±5%	10MHz	35	100MHz	85mA	5.33Ω	350MHz
LQW21HN1R8J00□	1.8μH ±5%	10MHz	35	100MHz	80mA	5.85Ω	320MHz
LQW21HN2R2J00□	2.2μH ±5%	10MHz	35	100MHz	75mA	6.50Ω	300MHz

Operating temp. range: -40 to 85°C
 Only for reflow soldering
 *S.R.F.: Self Resonant Frequency

Inductance-Frequency Characteristics (Typ.)



Q-Frequency Characteristics (Typ.)



LQH31HN_03 Series 1206 (3216) inch (mm)



Packaging Code	Packaging	Minimum Quantity
K	ø330mm Embossed Taping	7500
L	ø180mm Embossed Taping	2000

Continued on the following page. ↗

Continued from the preceding page. ↘

Part Number (□: packaging code)	Inductance	Inductance Test Frequency	Q (min.)	Q Test Frequency	Rated Current	DC Resistance	S.R.F.* (min.)
LQH31HNS4NK03□	54nH ±10%	1MHz	50	100MHz	920mA	0.035Ω±30%	800MHz
LQH31HN95NK03□	95nH ±10%	1MHz	60	100MHz	790mA	0.047Ω±30%	650MHz
LQH31HNR14J03□	145nH ±5%	1MHz	60	100MHz	700mA	0.061Ω±30%	500MHz
LQH31HNR14K03□	145nH ±10%	1MHz	60	100MHz	700mA	0.061Ω±30%	500MHz
LQH31HNR21J03□	215nH ±5%	1MHz	60	100MHz	520mA	0.11Ω±30%	430MHz
LQH31HNR21K03□	215nH ±10%	1MHz	60	100MHz	520mA	0.11Ω±30%	430MHz
LQH31HNR29J03□	290nH ±5%	1MHz	60	100MHz	420mA	0.17Ω±30%	360MHz
LQH31HNR29K03□	290nH ±10%	1MHz	60	100MHz	420mA	0.17Ω±30%	360MHz
LQH31HNR39J03□	390nH ±5%	1MHz	60	100MHz	330mA	0.26Ω±30%	300MHz
LQH31HNR39K03□	390nH ±10%	1MHz	60	100MHz	330mA	0.26Ω±30%	300MHz
LQH31HNR50J03□	500nH ±5%	1MHz	60	100MHz	260mA	0.44Ω±30%	270MHz
LQH31HNR50K03□	500nH ±10%	1MHz	60	100MHz	260mA	0.44Ω±30%	270MHz
LQH31HNR61J03□	610nH ±5%	1MHz	60	100MHz	250mA	0.48Ω±30%	240MHz
LQH31HNR61K03□	610nH ±10%	1MHz	60	100MHz	250mA	0.48Ω±30%	240MHz
LQH31HNR75J03□	750nH ±5%	1MHz	60	100MHz	190mA	0.79Ω±30%	220MHz
LQH31HNR75K03□	750nH ±10%	1MHz	60	100MHz	190mA	0.79Ω±30%	220MHz
LQH31HNR88J03□	880nH ±5%	1MHz	60	100MHz	180mA	0.86Ω±30%	200MHz
LQH31HNR88K03□	880nH ±10%	1MHz	60	100MHz	180mA	0.86Ω±30%	200MHz

Operating temp. range: -40 to 85°C

*S.R.F.: Self Resonant Frequency

Inductance-Frequency Characteristics (Typ.)



Q-Frequency Characteristics (Typ.)



RF Inductors ⚠️Caution/Notice

⚠️Caution

Rating

1. About the Rated Current

Do not use products beyond the rated current as this may create excessive heat and deteriorate the insulation resistance.

Be sure to provide an appropriate fail-safe function on your product to prevent a second damage that may be caused by the abnormal function or the failure of our product.

2. About Excessive Surge Current

Surge current (pulse current or rush current) greater than the specified rated current applied to the product may cause a critical failure, such as an open circuit or burnout caused by excessive temperature rise.

Please contact us in advance if applying a surge current.

Notice

Storage and Operating Condition

<Operating Environment>

Do not use products in a chemical atmosphere such as chlorine gas, acid or sulfide gas.

<Storage Requirements>

1. Storage Period

The LQG series should be used within 6 months; the other products should be used within 12 months.

Check solderability if this period is exceeded.

2. Storage Conditions

(1) Store products in a warehouse in compliance with the following conditions:

Temperature: -10 to +40 degrees C.

Humidity: 15 to 85% (relative humidity)

Do not subject products to rapid changes in temperature and humidity.

Do not store them in a chemical atmosphere such as one containing sulfurous acid gas, or alkaline gas or acid.

This will prevent electrode oxidation, which causes poor solderability and possible corrosion of inductors.

(2) Do not store products in bulk packaging to prevent collision among inductors, which causes core chipping and wire breakage.

(3) Store products on pallets to protect from humidity, dust, etc.

(4) Avoid heat shock, vibration, direct sunlight, etc.

Handling

This item is designed to have sufficient strength, but handle with care to avoid chipping or breaking its ceramic structure.

LQW series

- Temperature may rise up to max. 40°C when applying the rated current to LQW_C/LQW15AN_80/LQW18AN_80/LQW2BA/LQW2UA. Use caution regarding the temperature rating of the circuit.
- To prevent breaking the wire, avoid touching with sharp materials, such as tweezers or the bristles of a cleaning brush, to the wire wound portion.
- To prevent breaking the core, avoid applying excessive mechanical shock to products mounted on the board.
- In some mounting machines, when picking up components, a support pin pushes the components up from the bottom of the base tape. In this case, please remove the support pin. The support pin may damage the components and break the wire.

LQH series

- To prevent breaking the wire, avoid touching with sharp materials, such as tweezers or the bristles of a cleaning brush, to the wire wound portion of this product.
- To prevent breaking the core, avoid applying excessive mechanical shock to products mounted on the board.

LQP15/18 series

- The pattern of the products is covered with protective film. Take care to avoid damaging the products when handling it with pick-up nozzles, sharp instruments, etc.

<Transportation>

Do not apply excessive vibration or mechanical shock to products.

Continued on the following page. ↗

RF Inductors ⚠Caution/Notice

Continued from the preceding page. ↘

<Resin Coating>

- except LQP02/03 series

When coating products with resin, the relatively high resin curing stress may change inductance values. For exterior coating, select resin carefully so that electrical and mechanical performance of the product is not affected. Prior to use, please evaluate reliability with the product mounted in your application set.

- LQH, LQW series

An open circuit issue may occur by mechanical stress caused by the resin, amount/cured shape of resin, or operating conditions, etc. Some resins containing impurities or chloride may possibly generate chlorine by hydrolysis under some operating conditions, causing corrosion of the inductor wire and leading to an open circuit.

- LQP02/03 series

When products are coated with resin, please contact us in advance.

<Handling of a Substrate>

After mounting products on a substrate, do not apply any stress to the product caused by bending or twisting the substrate when cropping the substrate, inserting and removing a connector from the substrate, or tightening a screw to the substrate.

Excessive mechanical stress may cause cracking in the Product.

Bending



Twisting



Measuring Method

Measuring Method of Inductance/Q

- Residual elements and stray elements of test fixtures can be described by F-parameter as shown in the following:



- The impedance of products Z_x and measured value Z_m can be described by input/output current/voltage.

$$Z_m = \frac{V_1}{I_1}, \quad Z_x = \frac{V_2}{I_2}$$

- Thus, the relation between Z_x and Z_m is shown in the following:

$$Z_x = \alpha \frac{Z_m - \beta}{1 - Z_m \Gamma}$$

where, $\alpha = D / A = 1$

$\beta = B / D = Z_{sm} - (1 - Y_{om} Z_{sm}) Z_{ss}$

$\Gamma = C / A = Y_{om}$

Z_{sm} : measured impedance of short chip
 Z_{ss} : residual impedance of short chip*
 Y_{om} : measured admittance when opening the fixture)

*Residual inductance of short chip

Residual Inductance	Series
0nH	LQG15H, LQP03TG
0.110nH	LQP02HQ, LQP02TN, LQP02TQ
0.464nH	LQW04AN
0.480nH	LQP03HQ, LQP03PN, LQP03TN, LQP03TQ, LQW03AW
0.556nH	LQG15HN, LQW15A/C, LQP15M
0.771nH	LQG18HN, LQP18M, LQW18AN, LQW18C, LQW21/31H, LQW2BAN, LQH31

- L_x and Q_x should be calculated with the following equation.

$$L_x = \frac{\text{Im}(Z_x)}{2\pi f}, \quad Q_x = \frac{\text{Im}(Z_x)}{\text{Re}(Z_x)}$$

L_x : Inductance of products
 Q_x : Q of products
 f : Measuring frequency

Please refer to specification documents for LQW18AS, LQW2BAS, LQW2UAS, because they are different from other inductors regarding the inductance calculation method.

RF Inductors Soldering and Mounting

1. Standard Land Pattern Dimensions

A high Q value is achieved when the PCB electrode land pattern is designed so that it does not project beyond the products' electrode.

Land Pattern + Solder Resist
 Land Pattern
 Solder Resist
 (in mm)

Series	Standard Land Dimensions			
LQG15H LQG18H LQP02TN LQP02HQ/TQ LQP03HQ/P/T LQP15M LQP18M LQW03A LQW04A LQW15A/C LQW18A/C LQW21H LQW2BH LQW2BA LQW2UA LQW31H LQH31H				
	Part Number	a	b	c
	LQG15H	0.4	1.4 to 1.5	0.5 to 0.6
	LQG18H	0.6 to 0.8	1.8 to 2.2	0.6 to 0.8
	LQP02TN	0.16 to 0.2	0.4 to 0.56	0.2 to 0.23
	LQP02HQ/TQ	0.2	0.56	0.16
	LQP03HQ	0.3	0.9	0.25 to 0.3
	LQP03TN/TG/PN	0.2 to 0.3	0.8 to 0.9	0.2 to 0.3
	LQP03TQ	0.3	0.9	0.24
	LQP15M	0.4	1.4 to 1.5	0.5 to 0.6
	LQP18M	0.7 to 0.9	1.8 to 2.2	0.6 to 0.8
	LQW03A	0.23	0.65	0.4
	LQW04A	0.4	1.0	0.4
	LQW15A_00/10	0.5	1.2	0.65
	LQW15AN_80	0.6	1.42	0.66
	LQW15AW_80	0.51	1.23	0.66
	LQW15CN_00	0.4	1.4	0.6
	LQW15CN_10	0.4	1.4	0.66
	LQW18AN_00/10/AS_00	0.6 to 0.8	1.9 to 2.0	0.7 to 1.0
	LQW18AN_80	0.86	2.0	1.15
	LQW18AS_0C	0.65	2.0	1.0
	LQW18C	0.7	2.2	1.0
	LQW21H	1.0	2.6	1.2
	LQW2BH	0.8	3.0	1.2
	LQW2BA	0.76	2.8	1.78
LQW2UA	1.27	3.3	2.54	
LQH31H	1.0	4.5	1.5	
LQW31H				

Attention should be paid to potential magnetic coupling effects when using the Inductor (coil) as a resonator.

2. Standard Soldering Conditions

(1) Soldering method

Apply reflow soldering process except for flow soldering available products.

Please contact Murata regarding other soldering methods.

Solder: Use Sn-3.0Ag-0.5Cu solder.

Flux: Use rosin-based flux, but not strongly acidic flux (with chlorine content exceeding 0.2wt%).

Do not use water-soluble flux.

The flux used for the LQW03/04/15/18/21/2BA/2UA series should be a rosin-based flux that includes a middle activator equivalent to 0.06wt% to 0.1wt% chlorine.

Please pay attention to solder paste's penetrating in order to avoid short circuit between the lines.
 For additional mounting methods, please contact Murata.

Continued on the following page. ↗

RF Inductors Soldering and Mounting

Continued from the preceding page. ↘

(2) Soldering profile

● Flow Soldering profile



Series	Pre-heating		Standard Profile			Limit Profile		
	Temp. (T1)	Time. (t1)	Heating		Cycle of flow	Heating		Cycle of flow
			Temp. (T2)	Time. (t2)		Temp. (T3)	Time. (t2)	
LQW2BH/31H LQH31H	150°C	60s min.	250°C	4 to 6s	2 times max.	265±3°C	5s max.	2 times max.

● Reflow Soldering profile



Series	Standard Profile				Limit Profile			
	Heating		Peak temperature (T2)	Cycle of reflow	Heating		Peak temperature (T4)	Cycle of reflow
	Temp. (T1)	Time. (t1)			Temp. (T3)	Time. (t2)		
LQG15H/18H LQW03A/04A/15/18/21H LQW2BA/2UA LQP02/03/15M/18M LQW2BH/31H LQH31H	220°C	30 to 60s	245±3°C	2 times max.	230°C	60s max.	260°C/10s	2 times max.

(3) Reworking with a Soldering Iron

*Except for LQP02/LQW04/03/15AN_80/15AW_80 Series

Preheating at 150°C for 1 minute is required. Do not directly touch the ceramic element with the tip of the soldering iron. The reworking soldering conditions are as follows:

Soldering iron power output: 80W max.

Temperature of soldering iron tip: 350°C

Diameter of soldering iron end: 3.0mm max.

Soldering time: within 3 s

Please keep the fix time with the soldering iron within 1 time for each terminal.

Continued on the following page. ↗

RF Inductors Soldering and Mounting

Continued from the preceding page. ↘

3. Mounting Instructions

(1) Land Pattern Dimensions

Large land design tend to reduce Q value of the product. Also, large protruding land areas (bordered by lines having the dimensions "c" and "d" shown) cause floating and electrode leaching.



(2) Land Pattern Designing (LQW series)

Please follow the recommended patterns. Otherwise, their performance, which includes electrical performance or solderability, may be affected, or result in "position shift" in the soldering process.

(3) PCB Warping

The PCB should be designed so that products are not subjected to mechanical stress caused by warping the board.



Continued on the following page. ↗

RF Inductors Soldering and Mounting

Continued from the preceding page. ↘

(4) Amount of Solder Paste

Excessive solder causes electrode corrosion, while insufficient solder causes low electrode bonding strength. Adjust the amount of solder paste as shown on the right so that the correct amount is applied.

Guideline of solder paste thickness

- LQP (*Except for LQP02TN/LQP02TQ/HQ/LQP03TQ/HQ), LQG, LQW15AN_00/LQW15AN_10/LQW18AN/LQW18AS/LQW21H/LQW2BA/LQW2UA: 100 to 150μm
- LQP02TN: 50 to 80μm
- LQP02TQ/HQ: 50 to 65μm
- LQP03TQ/HQ: 100μm
- LQW03A/LQW04A: 80 to 100μm
- LQW15AN_80/15AW_80/15C/18C: 50 to 100μm
- LQW_H/LQH31H: 200 to 300μm



4. Cleaning

The following conditions should be observed when cleaning products:

- (1) Cleaning Temperature: 60°C max. (40°C max. for alcohol cleaning agents)
- (2) Ultrasonic
 - Output: 20W/l max.
 - Duration: 5 minutes max.
 - Frequency: 28 to 40kHz
 - Care should be taken not to cause resonance of the PCB and mounted products.

(3) Cleaning agent

The following cleaning agents have been tested on individual components. Evaluation in complete assembly should be done prior to production.

- (a) Alcohol cleaning agents
 - Isopropyl alcohol (IPA)
- (b) Aqueous cleaning agents
 - Pine Alpha ST-100S

- (4) Ensure that flux residue is completely removed. Component should be thoroughly dried after aqueous agents have been removed with deionized water.

For additional cleaning methods, please contact Murata.

RF Inductors Packaging

Minimum Quantity and 8mm Width Taping Dimensions



Paper Tape

Part Number	Dimensions		Total Thickness of Tape c	Packaging Code (Minimum Qty. (pcs.))		
	a	b		ø180mm reel	ø330mm reel	Bulk
LQG15H	0.62	1.12	0.8 max.	D (10000)	J (50000)	B (1000)
LQP02TN	0.24	0.47	0.39 max.	D (20000)	—	B (500)
LQP02TQ	0.23	0.45	0.39 max.	D (20000)	—	B (500)
LQP03HQ	0.36	0.68	0.55 max.	D (15000)	J (50000)	B (500)
LQP03TN/TG/TQ *1	0.35	0.65/0.67	0.55 max.	D (15000)	J (50000)	B (500)
LQP15M	0.70	1.20	0.8 max.	D (10000)	J (50000)	B (500)
LQP18M	1.19	2.0	0.8 max.	D (4000)	J (10000)	B (500)
LQW03A	0.52	0.65	0.75 max.	D (10000)	—	—
LQW04A	0.49	0.91	0.75 max.	D (10000)	—	B (500)
LQW15A_00 *2	0.64/0.66/0.69	1.18	0.8 max.	D (10000)	—	B (500)
LQW15A_10 *3	0.66/0.69	1.18	0.8 max.	D (10000)	—	B (500)
LQW15AN_80	0.75	1.18	0.8 max.	D (10000)	—	B (500)
LQW15AW_80	0.76	1.20	0.8 max.	D (10000)	—	B (500)
LQW15CN_00	0.64: 70nH to 200nH	1.18	0.8 max.	D (10000)	—	B (500)
	0.66: 18nH to 48nH					
LQW15C_10	0.69	1.18	0.8 max.	D (10000)	—	B (500)

*1 0.67 (LQP03TG · LQP03TN_02; 0.6 to 62nH, 130 to 270nH · LQP03PN, LQP03TQ)

0.65 (LQP03TN_02; 68 to 120nH)

*2 0.69 (1.5nH, 2.4 to 2.8nH, 3.9 to 4.8nH, 5.8 to 6.8nH, 8.2 to 9.9nH, 11nH, 12nH, 15nH)

0.66 (1.6 to 1.8nH, 2.9nH, 3.0nH, 3.1nH, 3.2nH, 4.9 to 5.1nH, 6.9 to 7.5nH, 10nH, 13nH, 16 to 23nH, 100nH, 120nH)

0.64 (24 to 91nH)

*3 0.69 (1.3nH, 1.4nH)

0.66 (2.2 to 8.4nH)

Embossed Tape

Part Number	Dimensions		Total Thickness of Tape c	Packaging Code (Minimum Qty. (pcs.))		
	a	b		ø180mm reel	ø330mm reel	Bulk
LQP02HQ	0.24	0.46	0.34 max.	E (15000)	—	B (500)

(in mm)

Continued on the following page. ↗

RF Inductors Packaging

Continued from the preceding page. ↘

Minimum Quantity and 8mm Width Taping Dimensions



The dimension of the cavity of embossed tape is measured at the bottom side.

Paper Tape

Part Number	Dimensions		Total Thickness of Tape	Packaging Code (Minimum Qty. (pcs.))		
	a	b		c	ø180mm reel	ø330mm reel
LQG18H	1.05	1.85	1.1 max.	D (4000)	J (10000)	B (1000)
LQW18AN_00	1.0	1.8	1.1 max.	D (4000)	J (10000)	B (500)
LQW18AN_10	1.1	1.9	1.1 max.	D (4000)	J (10000)	B (500)
LQW18AN_80	1.15	1.9	1.1 max.	D (4000)	J (10000)	B (500)
LQW18AS_00/0C	1.06	1.86	1.1 max.	D (4000)	J (10000)	B (500)
LQW18C	1.0	1.8	1.1 max.	D (4000)	J (10000)	B (500)

Embossed Tape

Part Number	Dimensions		Depth of Cavity	Packaging Code (Minimum Qty. (pcs.))		
	a	b		c	ø180mm reel	ø330mm reel
LQH31H, LQW31H	1.9	3.6	2.0	L (2000)	K (7500)	—
LQW21H	1.55	2.3	1.1	L (3000)	—	B (500)
LQW2BH	1.75	2.3	2.0	L (2000)	K (7500)	—
LQW2BA	1.8	2.3	1.65	L (2000)	K (8000)	B (500)
LQW2UA	2.7	2.8	2.15	L (2000)	—	B (500)

(in mm)

Minimum Quantity and 4mm Width Taping Dimensions



Embossed Tape

Part Number	Dimensions		Total Thickness of Tape	Packaging Code (Minimum Qty. (pcs.))		
	a	b		c	ø180mm reel	ø330mm reel
LQP02HQ	0.24	0.46	0.34 max.	L (30000)	—	B (500)
LQP02TN	0.21	0.43	0.23 max.	L (40000)	—	B (500)
LQP02TQ	0.22	0.47	0.23 max.	L (40000)	—	B (500)

(in mm)

Part Number Quick Reference

Series name (Part number): Indicated both series name and the initial letters of part number noted in brackets represents they are different.

Inductors for Power Lines

D52LC (#A914BY*)	88
D53LC High Current (#A915AY*)	89
D53LC Low Rdc (#A915BY*)	90
D63LCB (#A921CY*)	92
DEM10050C (1274AS*)	101
DEM10050C_DD (DD1274AS*)	102
DEM2812C (1225AS*)	69
DEM2815C (1226AS*)	69
DEM2818C (1227AS*)	70
DEM3512C (1229AS*)	76
DEM3518C (1231AS*)	76
DEM4518C (1235AS*)	84
DEM8030C (1273AS*)	98
DEM8040C (1248AS*)	98
DEM8045C (1217AS*)	99
DFE18SAN_EO	10
DFE18SAN_GO	10
DFE18SBN_EO	11
DFE201208S	12
DFE201210S	13
DFE201210U	13
DFE201610C (1285AS*)	14
DFE201610E	15
DFE201610P	16
DFE201610R	16
DFE201612C (1286AS*)	17
DFE201612E	18
DFE201612P	19
DFE201612R	19
DFE252007F	20
DFE252008C	21
DFE252008U	22
DFE252010C (1269AS*)	22
DFE252010F	23
DFE252010P	24
DFE252010R	25
DFE252012C (1239AS*)	26
DFE252012F	26
DFE252012P	27
DFE252012R	28
DFE322510C (1276AS*)	29
DFE322512C (1277AS*)	30
DFE322512F	30
DG6028C (1253AY*)	93
DG6045C (1255AY*)	93
DG6050C (1264EV*)	94
DG8040C (1267AY*)	100
DS104C2 (#B952AS*)	102
DS106C2 (#B966AS*/BS*)	103
DS126C2 (#B953AS*)	104
DS75LC (B1047AS*)	96
FCUL0530	38
FCUL0624	40
FCUL0630	40
FCUL1040	49
FCUL1060	49
FDA1055	46
FDA1254	51
FDSD0412	31
FDSD0415	32
FDSD0420	33
FDSD0420W	34
FDSD0512	34
FDSD0515	35
FDSD0518	36
FDSD0630	39
FDUE0630	44
FDUE0640	45

FDUE0650	46
FDUE1040D	47
FDUE1245	50
FDUE1260	52
FDV0530	37
FDV0530S	37
FDV0618	41
FDV0620	42
FDVE0630	43
FDVE0640	44
FDVE1040	48
LQH2HPN_DR	57
LQH2HPN_GR	58
LQH2HPN_JR	59
LQH2MPCN_02	53
LQH2MPCN_52	54
LQH2MPN_GR	55
LQH31CN_03	60
LQH32CN_23	60
LQH32CN_33	61
LQH32CN_53	62
LQH32DN_23	63
LQH32DN_53	64
LQH32PB_NO	65
LQH32PB_NC	66
LQH32PN_NO	67
LQH32PN_NC	68
LQH3NPN_GR	71
LQH3NPN_JR	72
LQH3NPN_ME	74
LQH43CN_03	80
LQH43CN_33	81
LQH43PB_26	82
LQH43PN_26	83
LQH44PN_GR	77
LQH44PN_JO	78
LQH44PN_PO	79
LQH55DN_03	91
LQH5BPB_TO	85
LQH5BPN_38	86
LQH5BPN_TO	87
LQH66SN_03	95
LQM18FN_00	106
LQM18PN_00	106
LQM18PN_CO	107
LQM18PN_DO	108
LQM18PN_DH	108
LQM18PN_FO	109
LQM18PN_FH	110
LQM18PN_FR	110
LQM18PN_GH	111
LQM18PNW_CH	112
LQM21DN_00	113
LQM21FN_00	113
LQM21FN_70	114
LQM21FN_80	115
LQM21PN_CO	115
LQM21PN_CA	116
LQM21PN_CH	117
LQM21PN_EH	118
LQM21PN_G0	119
LQM21PN_GC	120
LQM21PN_GH	121
LQM21PN_GR	121
LQM21PN_GS	122
LQM2HPN_CH	126
LQM2HPN_E0	127
LQM2HPN_EH	128
LQM2HPN_G0	129
LQM2HPN_GC	130

LQM2HPN_GH	130
LQM2HPN_GS	131
LQM2HPN_JO	132
LQM2HPN_JH	133
LQM2MPN_DH	123
LQM2MPN_EH	124
LQM2MPN_G0	124
LQM2MPN_GH	126
LQM31PN_00	133
LQM32PN_G0	134
LQM32PN_GC	135
LQW15DN_00	52

Inductors for General Circuits

LQB15NN_10	167
LQB18NN_10	168
LQH31MN_03	158
LQH32MN_23	160
LQH43MN_03	163
LQH43NN_03	165
LQH44NN_03	162
LQM18JN_00	169
LQM18NN_00	169
LQM21NN_10	170
LQW04CA_00	155
LQW15CA_00	155
LQW18CA_00	157

RF Inductors

LQG15HN_02	183
LQG15HS_02	185
LQG18HN_00	188
LQH31HN_03	261
LQP02HQ_02	189
LQP02TN_02	193
LQP02TQ_02	196
LQP03HQ_02	199
LQP03PN_02	203
LQP03TG_02	203
LQP03TN_02	206
LQP03TQ_02	210
LQP15MN_02	214
LQP18MN_02	215
LQW03AW_00	216
LQW04AN_00	218
LQW04AN_10	222
LQW15AN_00	223
LQW15AN_10	228
LQW15AN_80	230
LQW15AW_80	236
LQW15CN_00	258
LQW15CN_10	258
LQW18AN_00	237
LQW18AN_10	240
LQW18AN_80	241
LQW18AS_00	245
LQW18AS_0C	247
LQW18CN_00	260
LQW21HN_00	261
LQW2BAN_00	248
LQW2BAS_00	250
LQW2BHN_03	252
LQW2BHN_13	254
LQW2UAS_00	254
LQW31HN_03	257

Global Locations

For details please visit www.murata.com



⚠ Note

1 Export Control

For customers outside Japan:

No Murata products should be used or sold, through any channels, for use in the design, development, production, utilization, maintenance or operation of, or otherwise contribution to (1) any weapons (Weapons of Mass Destruction [nuclear, chemical or biological weapons or missiles] or conventional weapons) or (2) goods or systems specially designed or intended for military end-use or utilization by military end-users.

For customers in Japan:

For products which are controlled items subject to the "Foreign Exchange and Foreign Trade Law" of Japan, the export license specified by the law is required for export.

2 Please contact our sales representatives or product engineers before using the products in this catalog for the applications listed below, which require especially high reliability for the prevention of defects which might directly damage a third party's life, body or property, or when one of our products is intended for use in applications other than those specified in this catalog.

- ① Aircraft equipment
- ② Aerospace equipment
- ③ Undersea equipment
- ④ Power plant equipment
- ⑤ Medical equipment
- ⑥ Transportation equipment (vehicles, trains, ships, etc.)
- ⑦ Traffic signal equipment
- ⑧ Disaster prevention / crime prevention equipment
- ⑨ Data-processing equipment
- ⑩ Application of similar complexity and/or reliability requirements to the applications listed above

3 Product specifications in this catalog are as of August 2018. They are subject to change or our products in it may be discontinued without advance notice. Please check with our sales representatives or product engineers before ordering. If there are any questions, please contact our sales representatives or product engineers.

4 Please read rating and ⚠CAUTION (for storage, operating, rating, soldering, mounting and handling) in this catalog to prevent smoking and/or burning, etc.

5 This catalog has only typical specifications. Therefore, please approve our product specifications or transact the approval sheet for product specifications before ordering.

6 Please note that unless otherwise specified, we shall assume no responsibility whatsoever for any conflict or dispute that may occur in connection with the effect of our and/or a third party's intellectual property rights and other related rights in consideration of your use of our products and/or information described or contained in our catalogs. In this connection, no representation shall be made to the effect that any third parties are authorized to use the rights mentioned above under licenses without our consent.

7 No ozone depleting substances (ODS) under the Montreal Protocol are used in our manufacturing process.

Murata Manufacturing Co., Ltd.

www.murata.com

muRata
INNOVATOR IN ELECTRONICS

Looking for pricing, stock, or lifecycle information?

Click below to explore more details on WIN SOURCE:

- ⊖ [View LQW15CN96NJ00D on WIN SOURCE](#)
- ⊖ [Murata Electronics North America Information](#)

Optimize Your Supply Chain with WIN SOURCE Solutions

- ✓ Global Sourcing Solution
- ✓ Obsolete Management
- ✓ Cost Control Management
- ✓ Shortage Management
- ✓ Alternative Solution
- ✓ Excess Inventory Management